



US00D903135S

(12) **United States Design Patent** (10) **Patent No.:** **US D903,135 S**
Xiao (45) **Date of Patent:** **** Nov. 24, 2020**

(54) **PHOTOTHERAPY LAMP**
(71) Applicant: **Lulin Xiao**, Linxiang (CN)
(72) Inventor: **Lulin Xiao**, Linxiang (CN)
(**) Term: **15 Years**
(21) Appl. No.: **29/739,362**

D736,942 S * 8/2015 Hagenauer D24/210
D736,943 S 8/2015 Hagenauer
D760,398 S * 6/2016 Douglas D24/210
D807,522 S * 1/2018 Berke D24/210
D831,651 S 10/2018 Bao
D857,219 S 8/2019 Chew
D875,265 S * 2/2020 Li D24/210
D879,984 S * 3/2020 Hu D24/209
D893,039 S * 8/2020 Harmon D24/209
2007/0129777 A1 * 6/2007 Bolta A61N 5/0618
607/88

(22) Filed: **Jun. 24, 2020**
(51) **LOC (12) Cl.** **28-03**
(52) **U.S. Cl.**
USPC **D24/210**
(58) **Field of Classification Search**
USPC D24/107, 186, 200, 209, 210, 231;
D26/93, 104, 106, 120; D6/308-312
CPC A61N 5/062; A61N 5/0614; A61N 5/0616;
A61N 5/0617; A61N 5/0618; A61N
5/0624; A61N 5/0627; A61N 5/0625;
A61N 2005/0643; A61N 2005/0644;
A61N 2005/0645; A61N 2005/0647;
A61N 2005/0651; A61N 2005/0652;
A61N 2005/0654; A61N 2005/0662;
A61B 2018/00452; A61B 2018/1807
See application file for complete search history.

* cited by examiner

Primary Examiner — Anhdao Doan
(74) *Attorney, Agent, or Firm* — ScienBiziP, P.C.

(57) **CLAIM**

The ornamental design for a phototherapy lamp, as shown and described.

DESCRIPTION

FIG. 1 is a front and right perspective view of a phototherapy lamp, showing my design;
FIG. 2 is a rear and right perspective view thereof;
FIG. 3 is a front elevation view thereof;
FIG. 4 is a rear elevation view thereof;
FIG. 5 is a left side elevation view thereof;
FIG. 6 is a right side elevation view thereof;
FIG. 7 is a top plan view thereof; and,
FIG. 8 is a bottom plan view thereof.
The broken lines in FIGS. 1 and 3 illustrate a portion of the phototherapy lamp that forms no part of the claimed design; the broken lines form no part of the claimed design.

(56) **References Cited**
U.S. PATENT DOCUMENTS
D599,485 S * 9/2009 Burrows D24/209
D641,490 S * 7/2011 Fernie D24/210
D704,851 S * 5/2014 Douglas D24/209

1 Claim, 8 Drawing Sheets

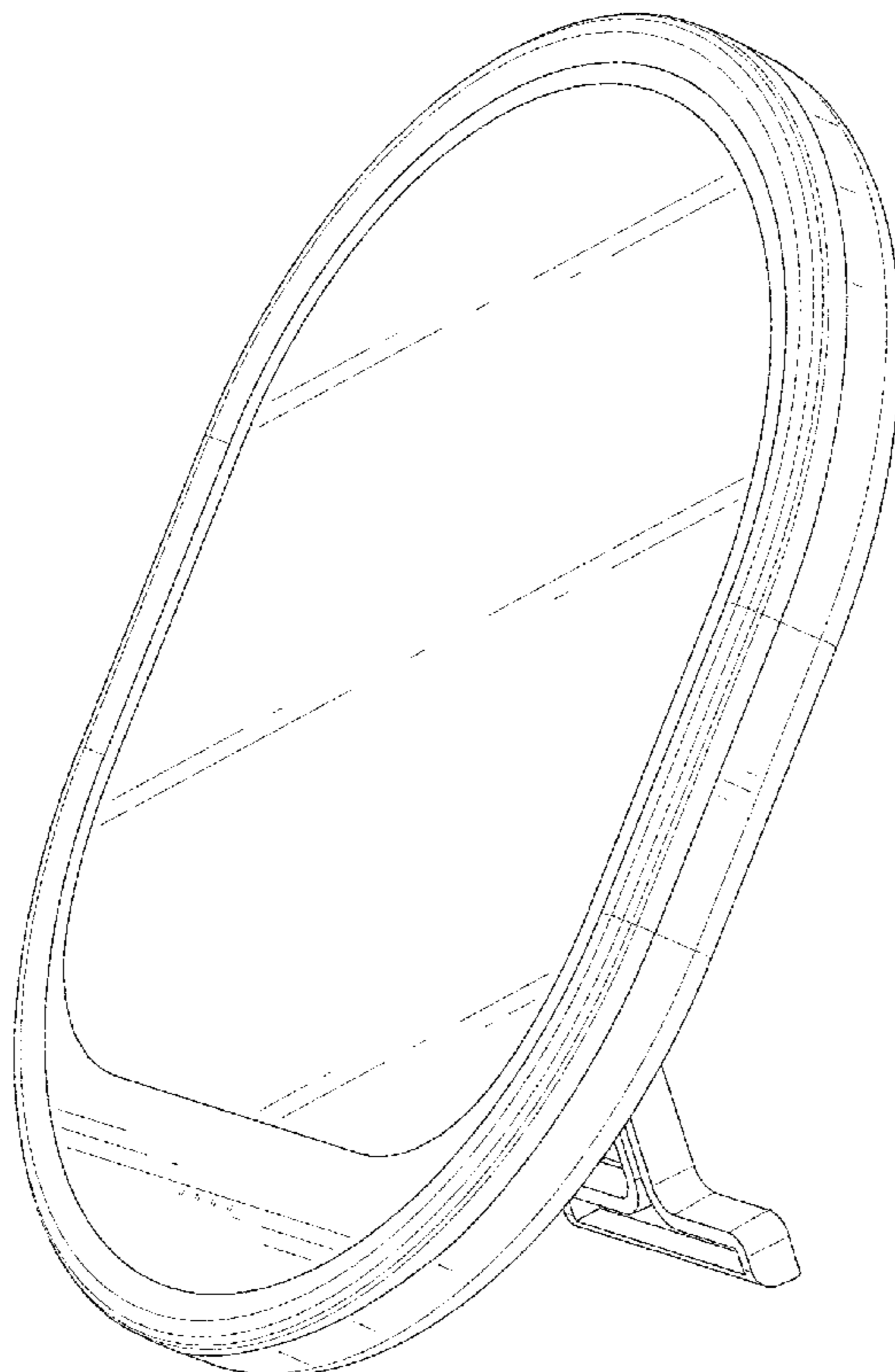

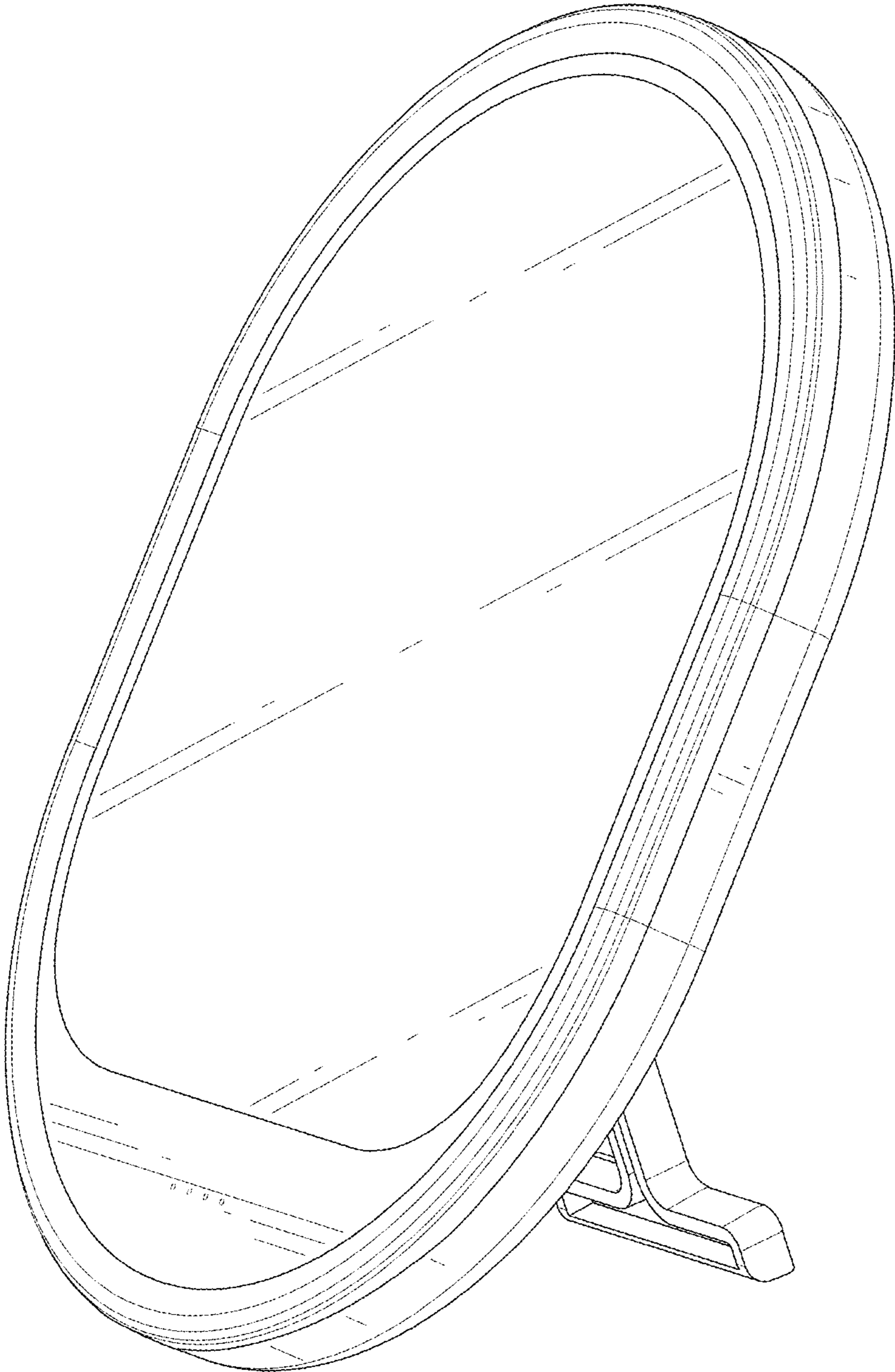

FIG.1

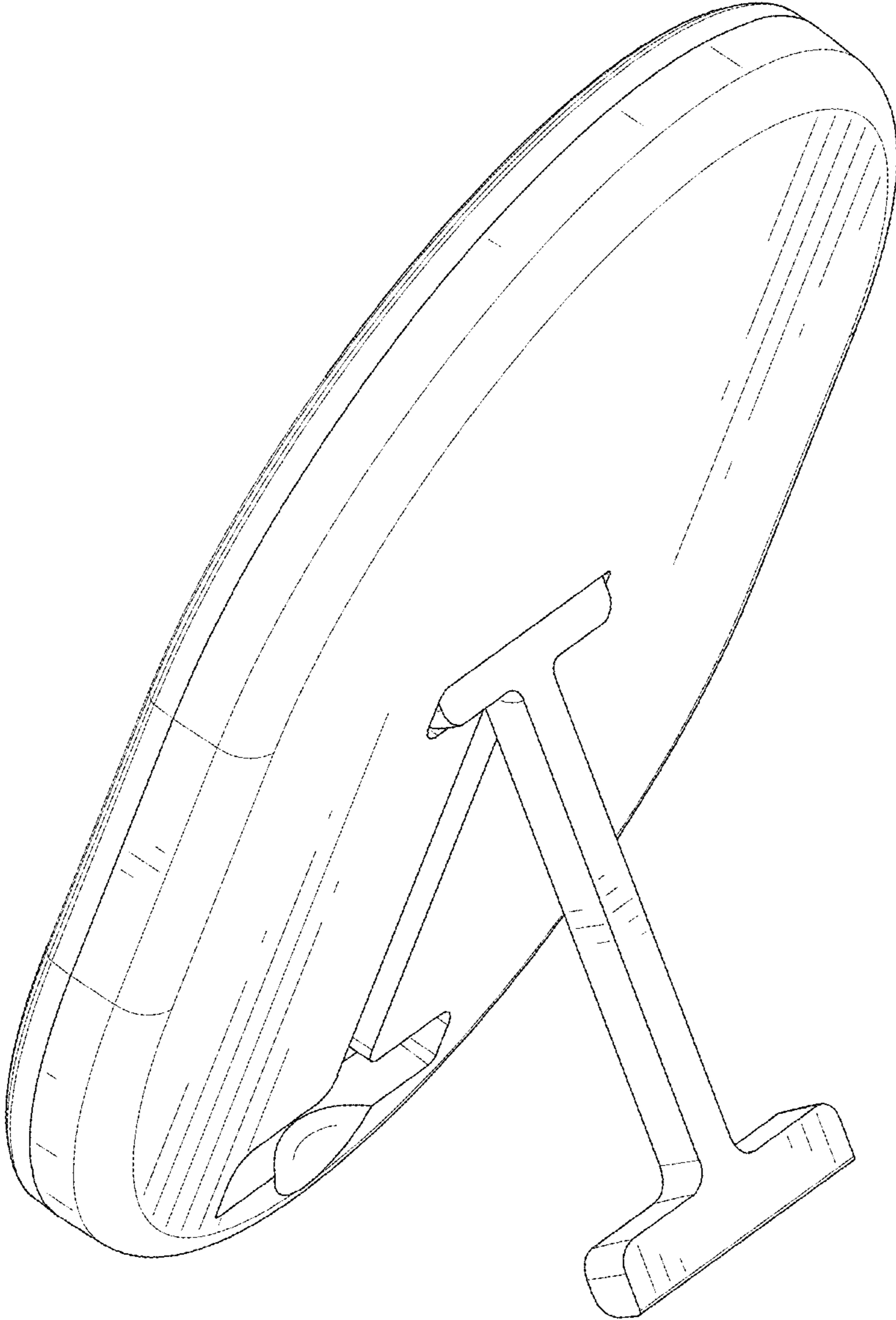

FIG.2

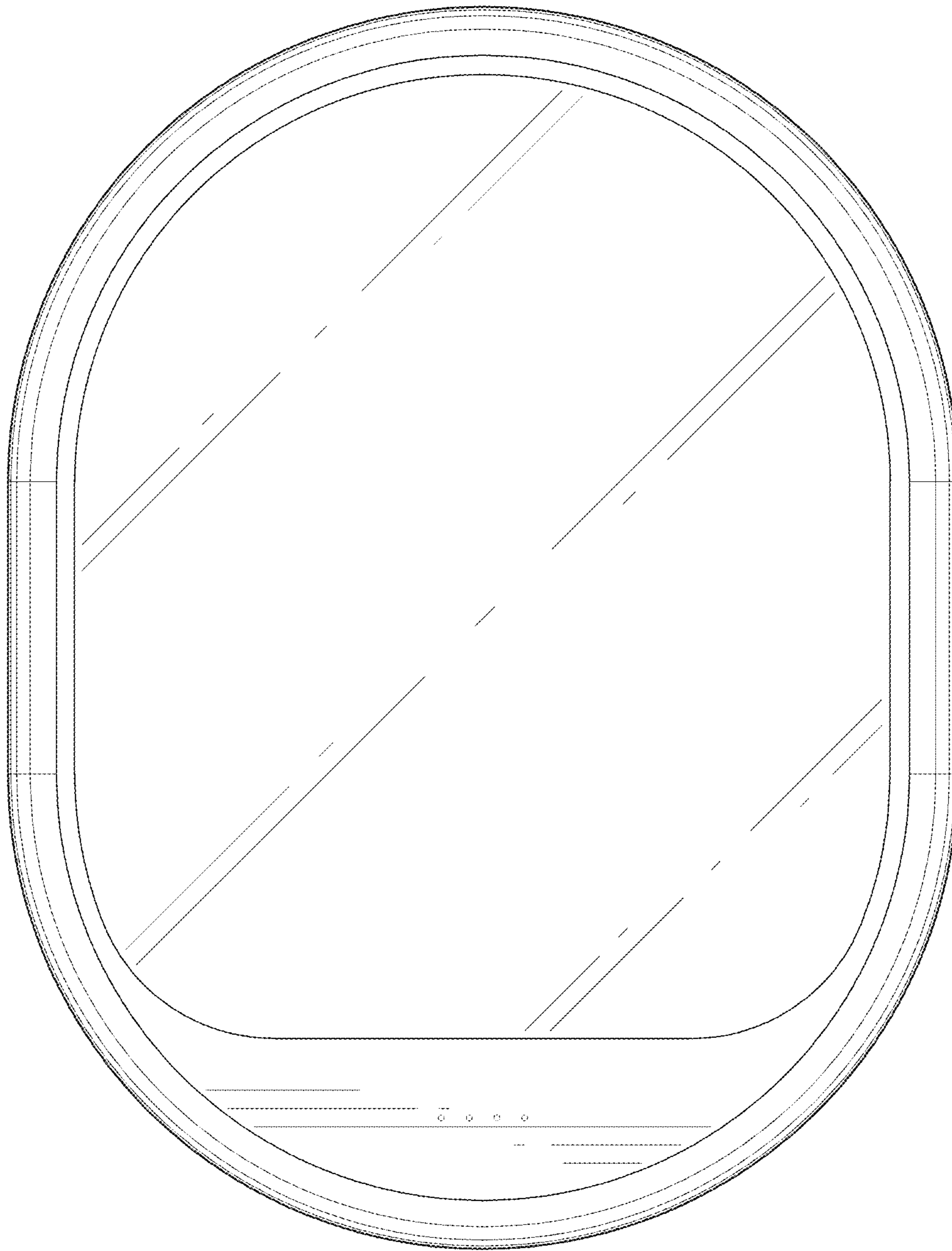

FIG.3

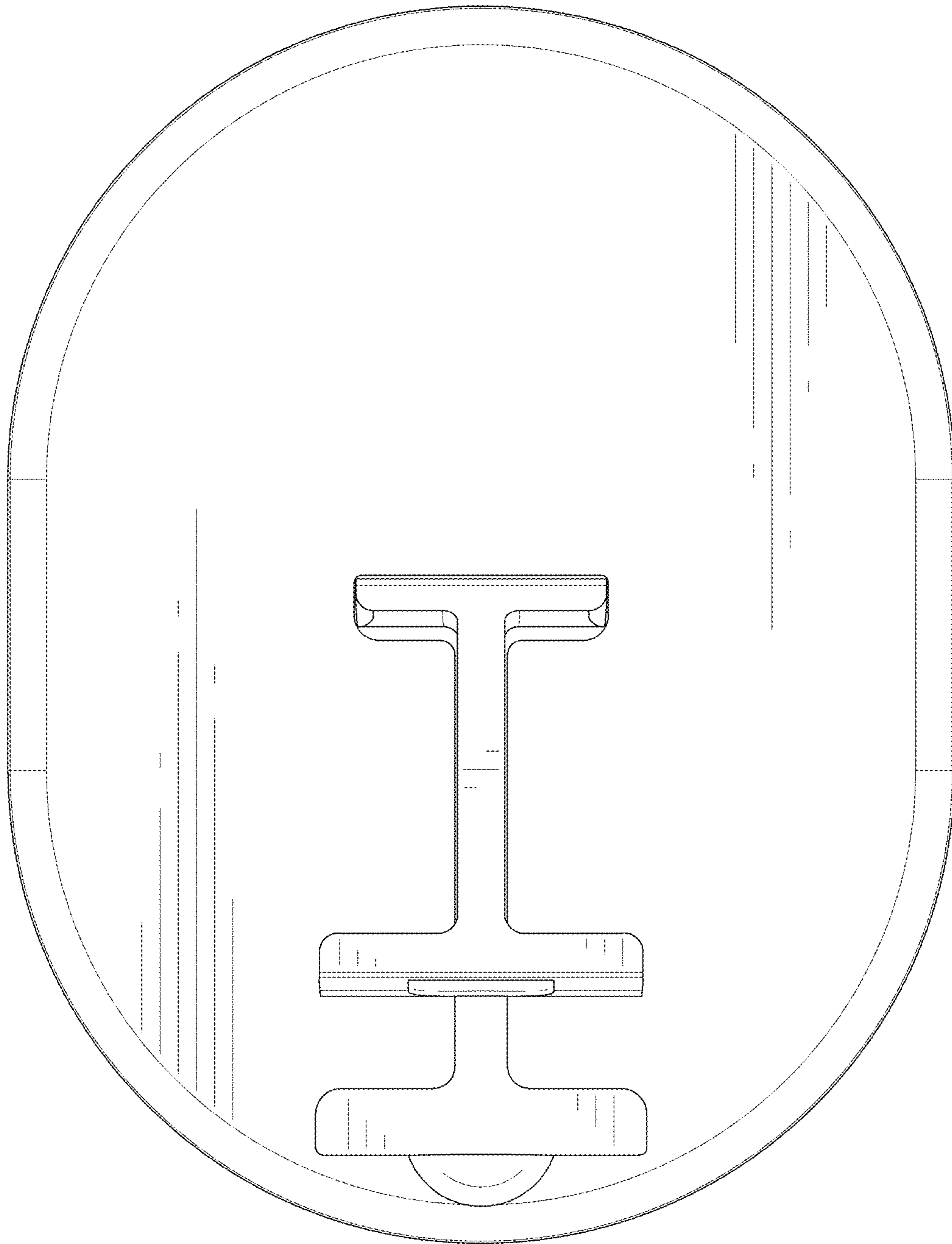

FIG. 4

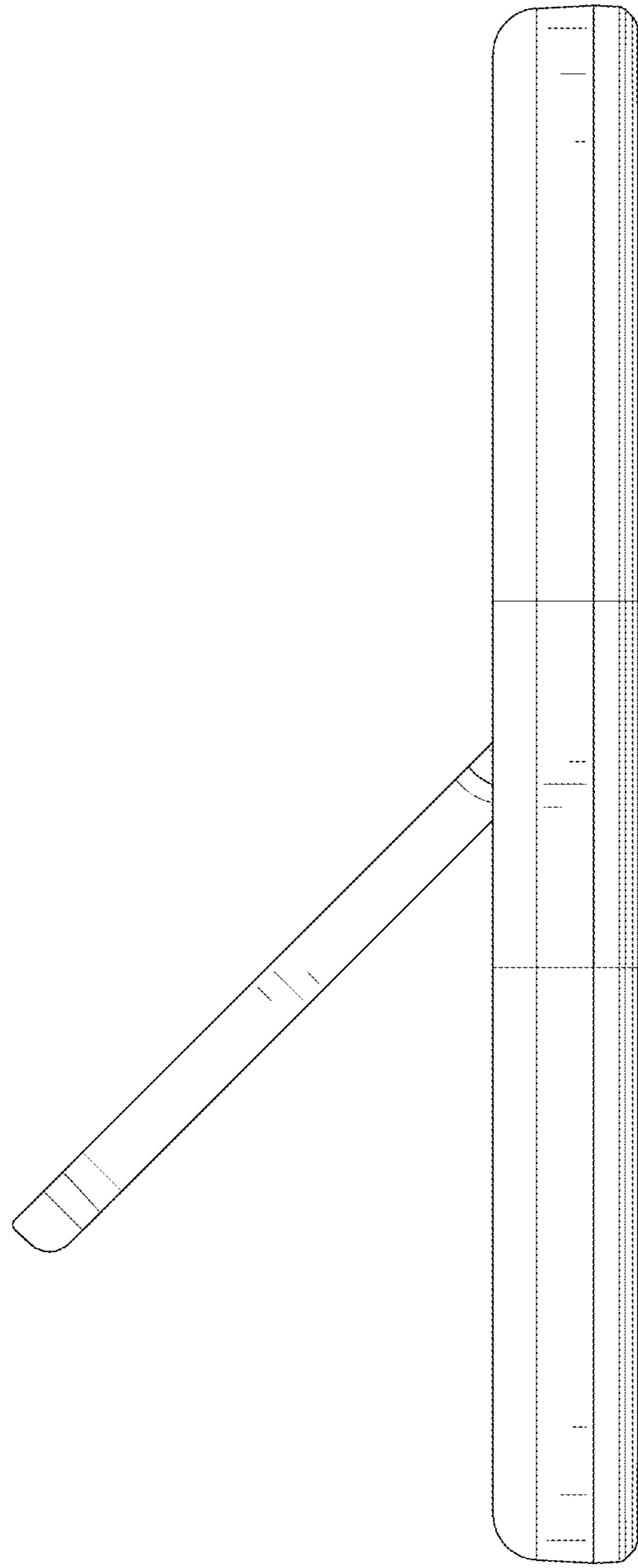

FIG.5

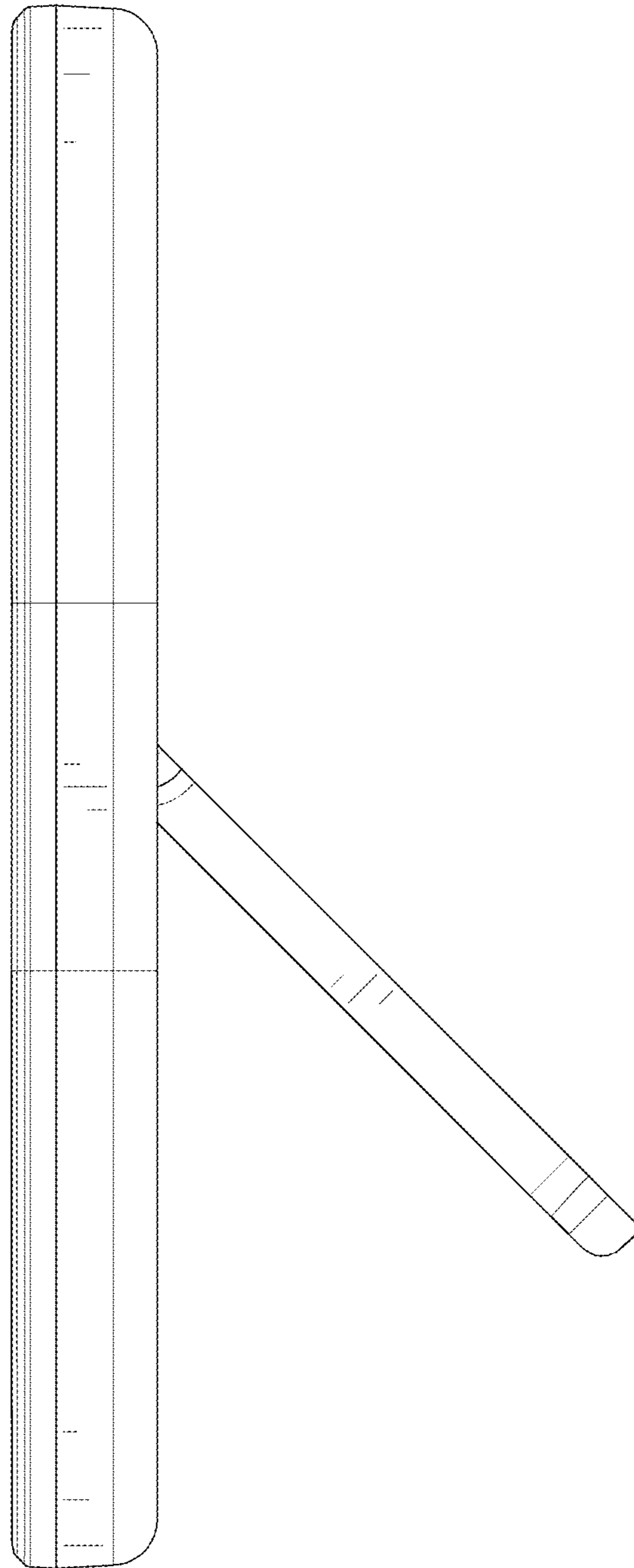

FIG.6

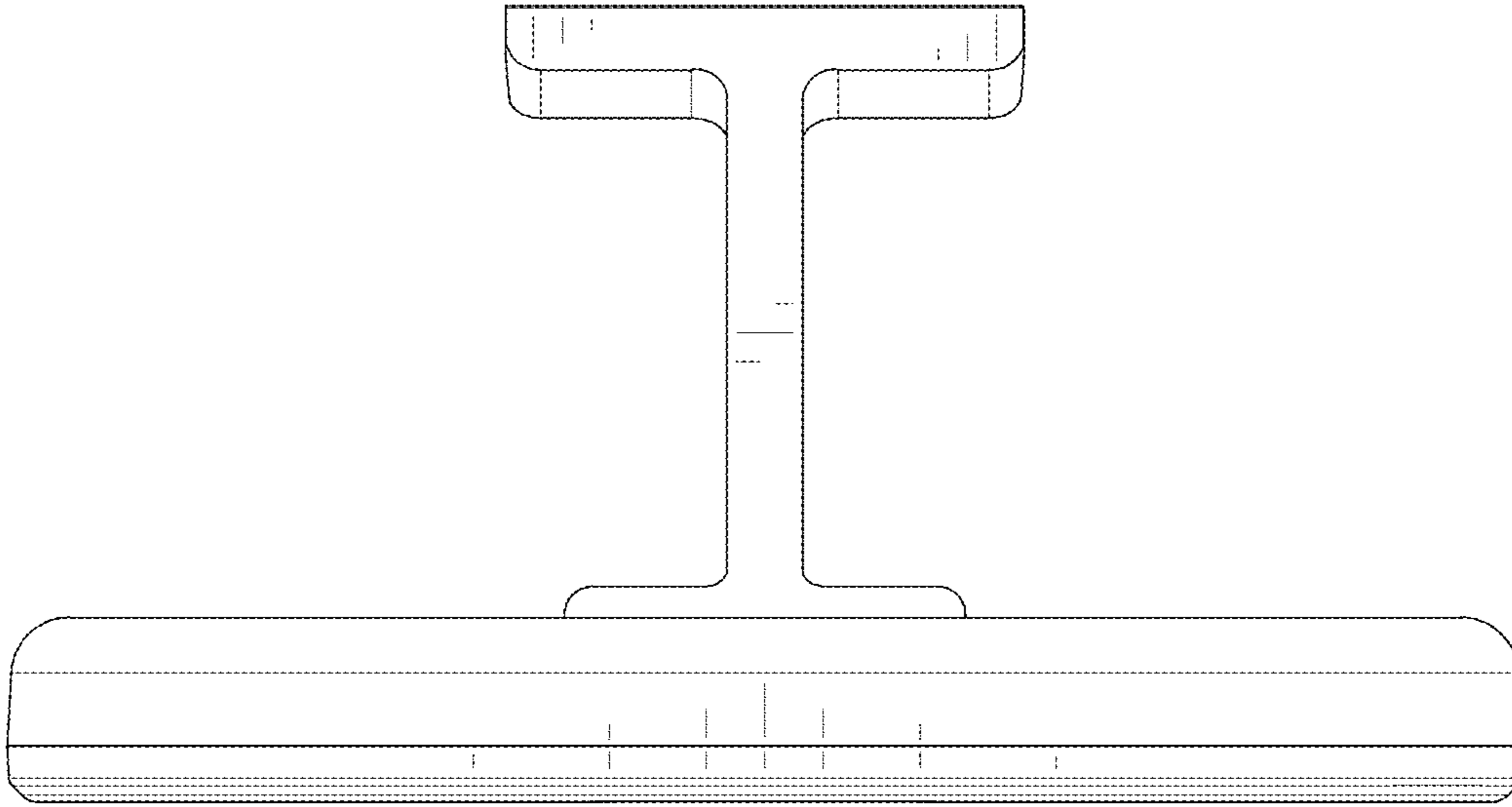

FIG.7

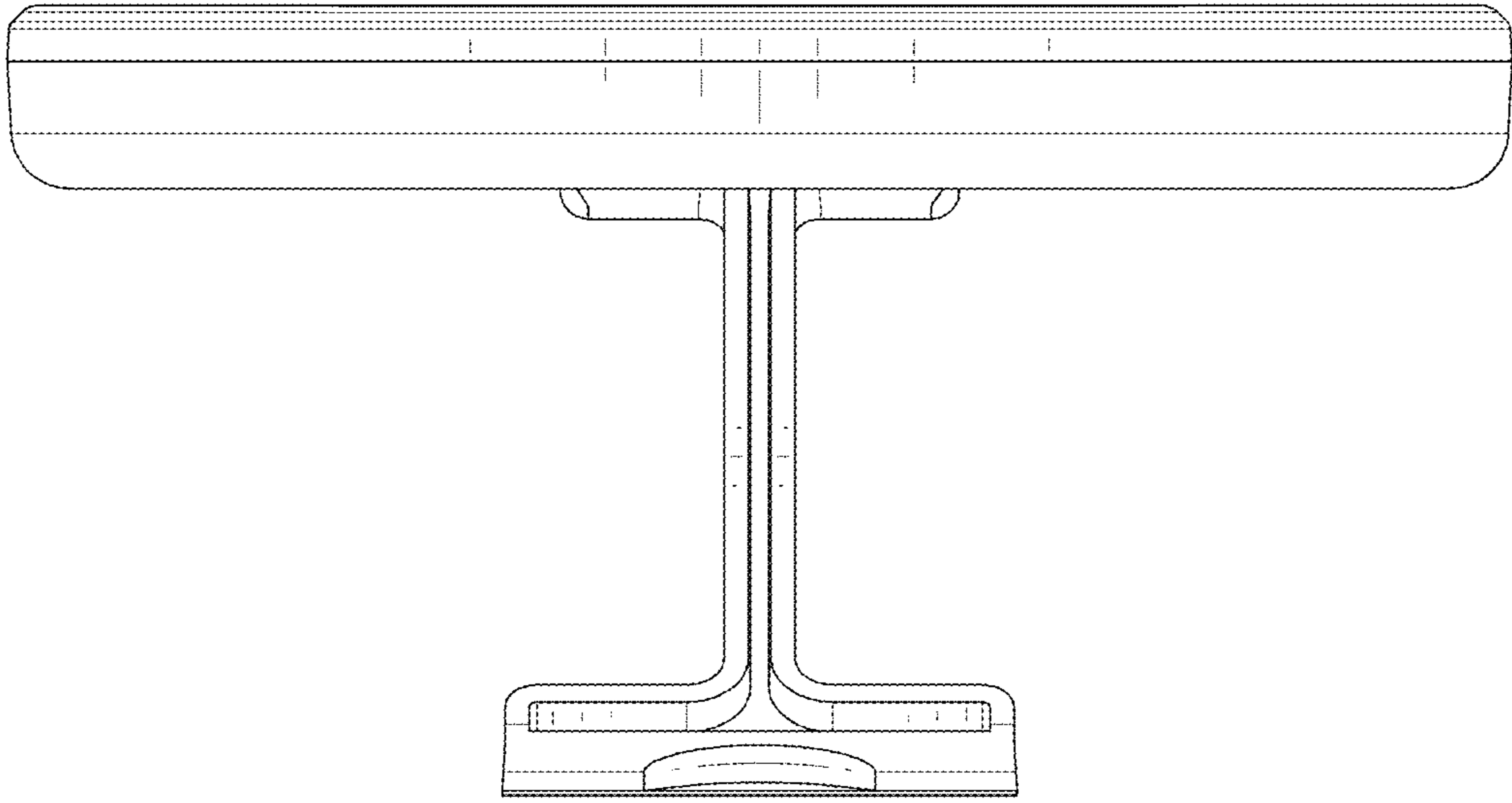

FIG.8