



US00D903123S

(12) **United States Design Patent**
Farrell

(10) **Patent No.:** **US D903,123 S**

(45) **Date of Patent:** **** Nov. 24, 2020**

(54) **ORAL APPLIANCE**

(71) Applicant: **Christopher John Farrell**, Helensvale (AU)

(72) Inventor: **Christopher John Farrell**, Helensvale (AU)

(**) Term: **15 Years**

(21) Appl. No.: **29/671,041**

(22) Filed: **Nov. 21, 2018**

(30) **Foreign Application Priority Data**

May 25, 2018 (AU) 201813153

(51) **LOC (12) Cl.** **24-02**

(52) **U.S. Cl.**
USPC **D24/181; D24/180**

(58) **Field of Classification Search**
USPC D24/180, 181, 194, 176, 177, 178, 179, D24/182, 110, 110.1-110.6, 127, 108; D29/108, 122, 128
CPC A61F 5/566; A61F 2005/563; A61H 2001/0207; A63B 71/085; A63B 2071/086; A63B 71/0054; A61C 7/08; A61C 7/36; A61C 7/143; A61C 7/148; A61C 19/05

See application file for complete search history.

(56) **References Cited**

U.S. PATENT DOCUMENTS

3,079,916 A * 3/1963 Marsden A61M 16/0048 128/202.28
3,303,845 A * 2/1967 Detmer, III A61M 16/0048 128/202.28
3,457,916 A * 7/1969 Wolicki A63B 71/085 128/862
4,179,811 A * 12/1979 Hinz A61C 7/00 433/6

4,235,594 A * 11/1980 Schwartz A61C 9/00 433/213
D263,166 S * 2/1982 Bushman D24/110
D265,586 S * 7/1982 Sloan D24/122
D283,158 S * 3/1986 Jackson 128/207.14

(Continued)

FOREIGN PATENT DOCUMENTS

WO 2012155214 11/2012
WO 2015149127 10/2015

(Continued)

Primary Examiner — T Chase Nelson

Assistant Examiner — Kelly L Gross

(74) *Attorney, Agent, or Firm* — McAndrews, Held & Malloy, Ltd.

(57) **CLAIM**

The ornamental design for an oral appliance, as shown and described.

DESCRIPTION

FIG. 1 is a front perspective view of an oral appliance showing my new design according to a first embodiment; FIG. 2 is a rear perspective view thereof; FIG. 3 is a front elevation view thereof; FIG. 4 is a rear elevation view thereof; FIG. 5 is a left side elevation view thereof; the right side elevation view being a mirror image thereof; FIG. 6 is a top plan view thereof; FIG. 7 is a bottom plan view thereof; FIG. 8 is a front perspective view of an oral appliance showing my new design according to a second embodiment; FIG. 9 is a rear perspective view thereof; FIG. 10 is a front elevation view thereof; FIG. 11 is a rear elevation view thereof; FIG. 12 is a left side elevation view thereof; the right side elevation view being a mirror image thereof; FIG. 13 is a top plan view thereof; and, FIG. 14 is a bottom plan view thereof.

1 Claim, 12 Drawing Sheets

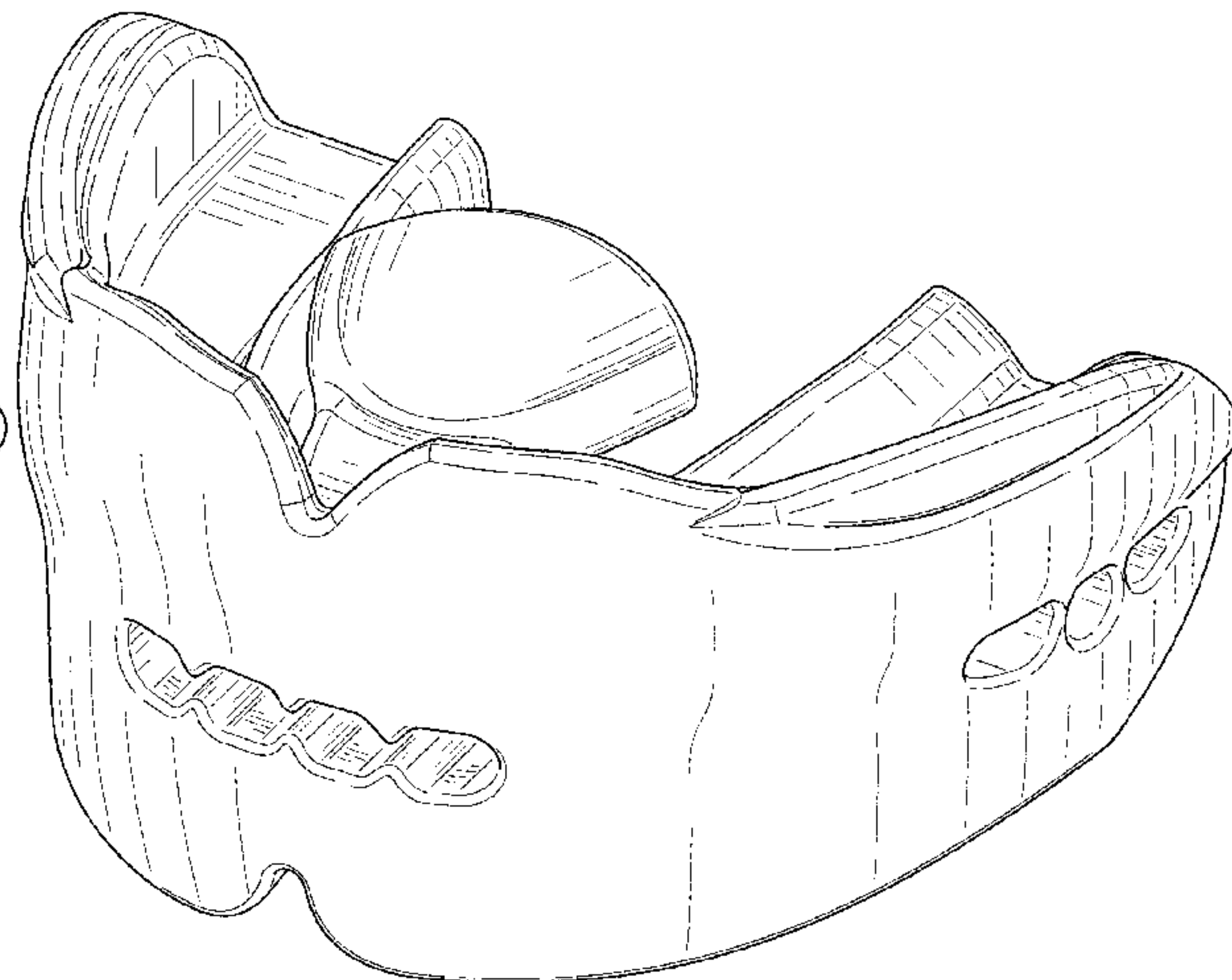
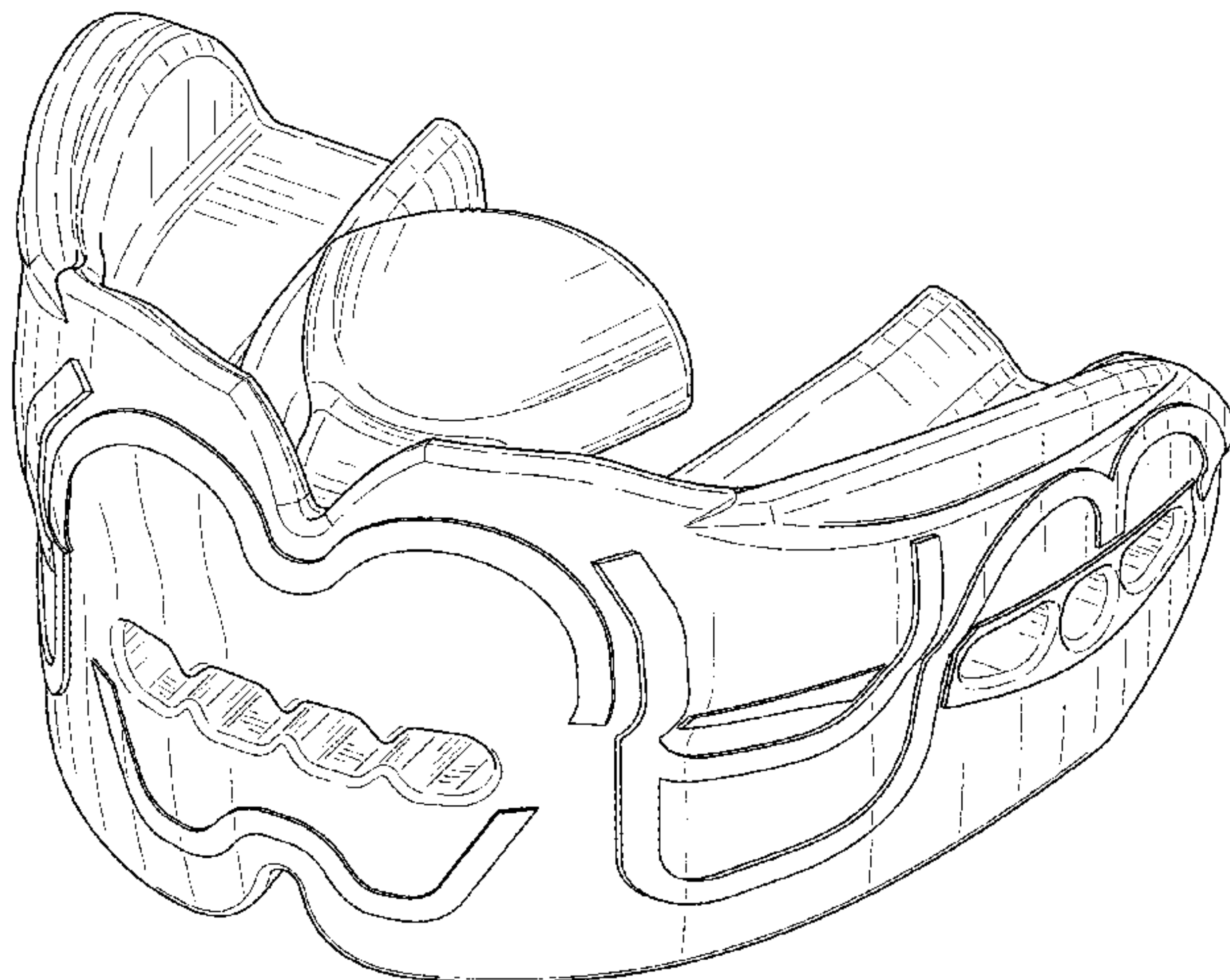

(56)

References Cited

U.S. PATENT DOCUMENTS

4,695,417 A * 9/1987 Hall A61C 7/08
264/16
4,715,368 A * 12/1987 George A61F 5/566
128/859
D295,797 S * 5/1988 Bono D24/110.5
D301,618 S * 6/1989 Barros D24/110
D302,036 S * 7/1989 George D24/110
D303,440 S * 9/1989 Campbell D24/110.5
D311,607 S * 10/1990 Howells D24/110
RE33,442 E * 11/1990 George A61M 16/0493
128/860
4,986,751 A * 1/1991 Bergersen A61C 7/08
433/6
5,028,231 A * 7/1991 Hall A61C 7/08
264/16
5,031,611 A * 7/1991 Moles B63C 11/186
128/201.11
5,062,422 A * 11/1991 Kinkade B63C 11/186
128/200.26
5,092,346 A 3/1992 Hays et al.
5,117,816 A * 6/1992 Shapiro A61F 5/566
128/200.24
D329,901 S * 9/1992 Jackson D24/176
5,305,741 A * 4/1994 Moles B63C 11/186
128/201.11
5,353,810 A * 10/1994 Kittelsen A63B 71/085
128/859
5,462,066 A * 10/1995 Snyder A61F 5/566
128/848
5,792,067 A 8/1998 Karrell
D399,950 S * 10/1998 Shepard D24/110.5
D406,647 S * 3/1999 Wagner D24/181
6,405,729 B1 * 6/2002 Thornton A61F 5/566
128/206.29
D461,240 S * 8/2002 Dort D24/105
D479,876 S * 9/2003 Gradon D24/110
D504,947 S * 5/2005 McAuley D24/110
D528,655 S * 9/2006 Clawson D24/110
D536,441 S * 2/2007 Garren D24/110
D538,926 S * 3/2007 Jeong D24/110
D542,408 S * 5/2007 Oldenburg D24/110.5
D595,413 S * 6/2009 Farrell D24/181
D605,285 S * 12/2009 Garren D24/110
D609,347 S * 2/2010 Farrell D24/180
D609,348 S * 2/2010 Farrell D24/181
D615,187 S * 5/2010 Bowden D24/110
D615,709 S * 5/2010 Manzo D29/108
D618,399 S * 6/2010 Manzo D29/108
D626,292 S * 10/2010 Farrell D29/108
D627,107 S * 11/2010 Manzo D29/108
D629,909 S * 12/2010 Chiu D24/181
D630,382 S * 1/2011 Manzo D29/108
D634,480 S * 3/2011 Manzo D29/108
D636,074 S * 4/2011 Levine D24/110.5
D642,277 S * 7/2011 Farrell D24/181
D648,900 S * 11/2011 Manzo D29/108
D650,066 S * 12/2011 Boyd D24/110.5
D652,575 S * 1/2012 Farrell D29/108
D652,576 S * 1/2012 Farrell D29/108
D654,173 S * 2/2012 Farrell D24/181
D654,595 S * 2/2012 Farrell D24/181
D662,586 S * 6/2012 Coath D24/110
D683,030 S * 5/2013 Croll D24/181
D683,446 S * 5/2013 Eves D24/110.4
8,448,282 B2 * 5/2013 Stapelbroek A61C 7/08
15/167.2
D695,889 S * 12/2013 Bruggeman D24/110.5
D717,447 S * 11/2014 Farrell D24/181
D717,449 S * 11/2014 Farrell D24/181
D717,450 S * 11/2014 Farrell D24/181
D727,570 S * 4/2015 Brett D29/108

9,005,120 B2 * 4/2015 Ryan A61B 5/682
600/301
D734,556 S * 7/2015 Brett D24/181
D753,817 S * 4/2016 Maguire D24/110.5
D760,889 S * 7/2016 Evans D24/110.5
D765,255 S * 8/2016 Levine D24/181
D765,919 S * 9/2016 Croll D29/108
D767,146 S * 9/2016 Farrell D24/181
D782,743 S * 3/2017 Engel D29/108
9,630,082 B2 * 4/2017 Zents A63B 71/085
D795,501 S * 8/2017 Levine D29/108
9,717,975 B2 * 8/2017 Evans A63B 71/085
D799,049 S * 10/2017 Farrell D24/181
D800,315 S * 10/2017 Crowley D24/176
D800,317 S * 10/2017 Farrell D24/181
9,848,959 B2 * 12/2017 Lowe A61C 17/005
D815,291 S * 4/2018 Farrell D24/181
D816,210 S * 4/2018 Gerschman D24/110.5
D833,622 S * 11/2018 Farrell D24/181
D836,204 S * 12/2018 Montgomery D24/181
10,149,782 B2 * 12/2018 Chen A61M 16/0493
D838,839 S * 1/2019 Fujiwara D24/110.5
D839,485 S * 1/2019 Turkbash D29/108
D841,257 S * 2/2019 Turkbash D29/108
D841,818 S * 2/2019 Farrell D24/181
D842,999 S * 3/2019 Fleury D24/197
D851,749 S * 6/2019 Siew D24/110.1
D853,655 S * 7/2019 Turkbash D29/108
D854,679 S * 7/2019 Gerschman D24/110.5
D854,753 S * 7/2019 Turkbash D29/108
D857,301 S * 8/2019 Turkbash D29/108
D857,998 S * 8/2019 Turkbash D29/108
D864,399 S * 10/2019 Qin D24/176
D867,673 S * 11/2019 Turkbash D29/108
D869,774 S * 12/2019 Turkbash D29/108
D871,571 S * 12/2019 Chen A61F 5/566
D24/110.5
D872,281 S * 1/2020 Brauteseth D24/181
D874,654 S * 2/2020 Martone D24/180
D875,237 S * 2/2020 Ghazzawi D24/110
D876,728 S * 2/2020 Evans D29/108
10,568,757 B2 * 2/2020 Radmand A61F 5/566
D877,340 S * 3/2020 Montgomery D24/176
2003/0019497 A1 * 1/2003 Farrell A61C 7/08
128/861
2004/0103905 A1 * 6/2004 Farrell A61C 7/08
128/861
2007/0099144 A1 * 5/2007 Keski-Nisula A61C 7/08
433/6
2008/0257358 A1 10/2008 Stern et al.
2010/0311003 A1 12/2010 Kozlov
2011/0185525 A1 * 8/2011 Stapelbroek A61C 7/08
15/167.1
2013/0263864 A1 * 10/2013 von Treuenfels A61F 5/566
128/848
2014/0190490 A1 * 7/2014 Walker A61F 5/566
128/848
2014/0276171 A1 * 9/2014 Hestness A61B 5/0833
600/531
2014/0326253 A1 * 11/2014 Baratier A61F 5/566
128/848
2015/0079530 A1 * 3/2015 Bergersen A61C 7/08
433/6
2015/0157821 A1 * 6/2015 Manecke A61M 16/0434
600/114
2016/0338813 A1 * 11/2016 Kamohara A61C 9/0006
2017/0173356 A1 * 6/2017 Demarest A61C 5/90
2018/0078405 A1 * 3/2018 Farrell A61F 5/566
2018/0228643 A1 * 8/2018 Goldstein A61C 5/90

FOREIGN PATENT DOCUMENTS

WO 2017020079 2/2017
WO 2017/165918 10/2017

* cited by examiner

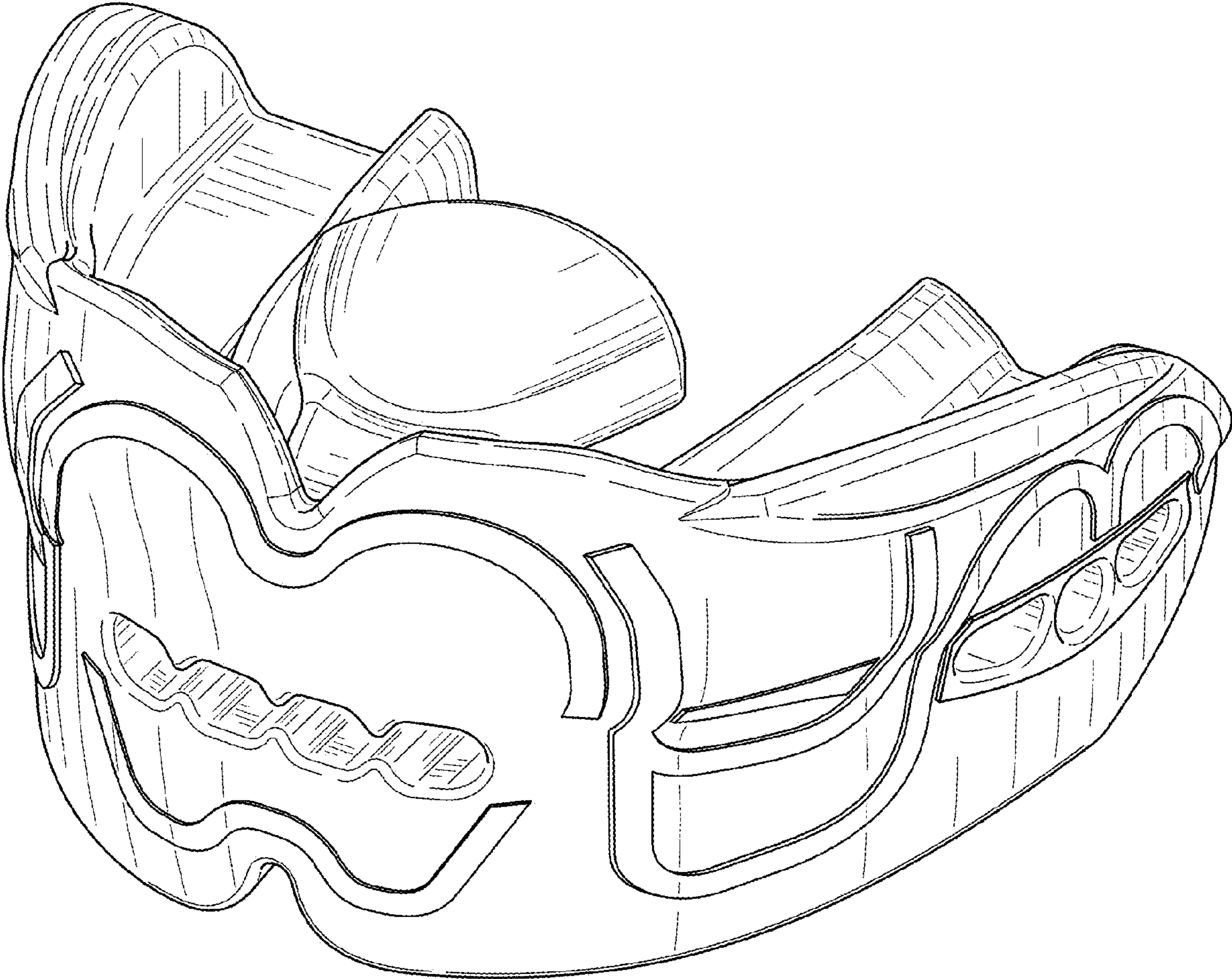

FIG. 1

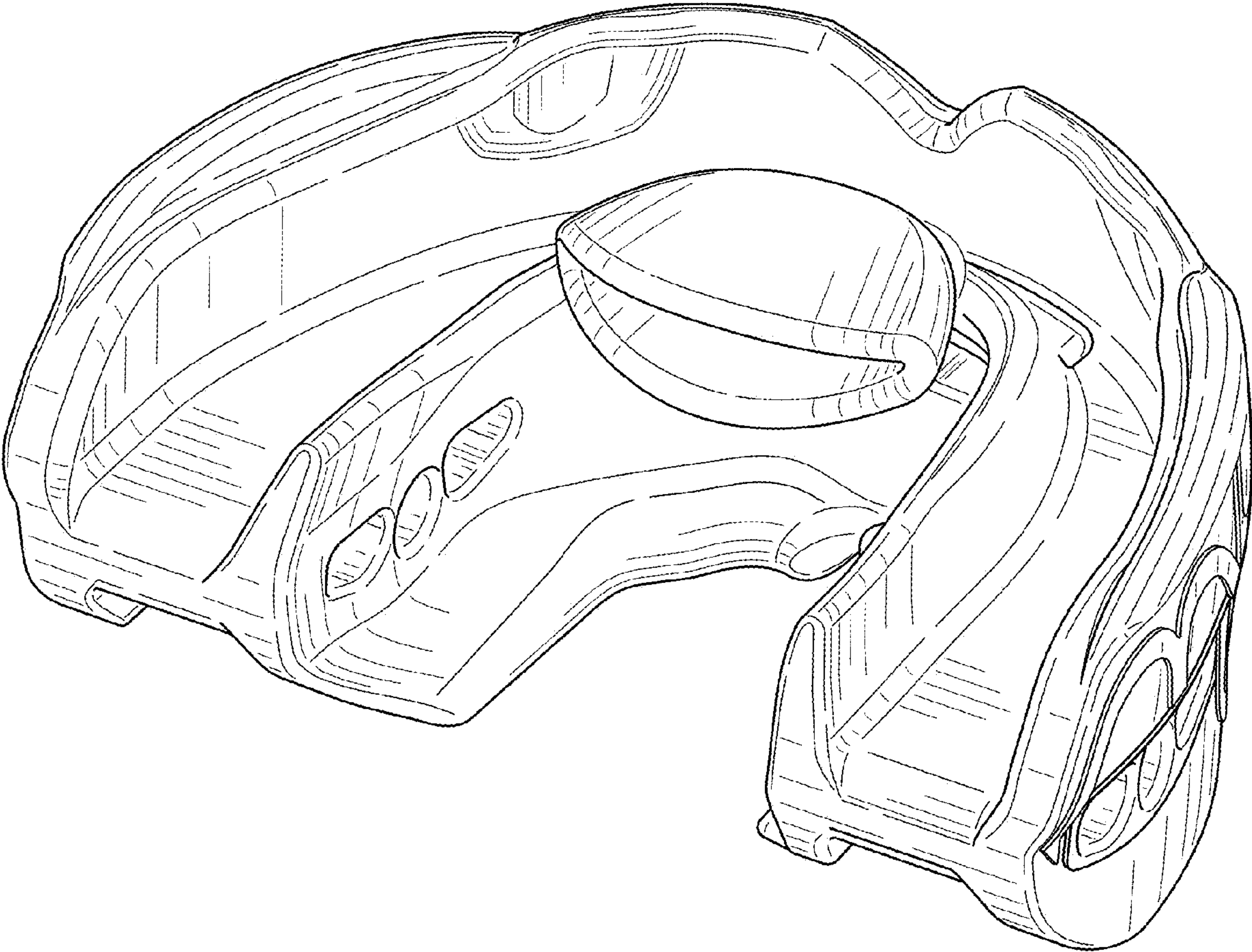

FIG. 2

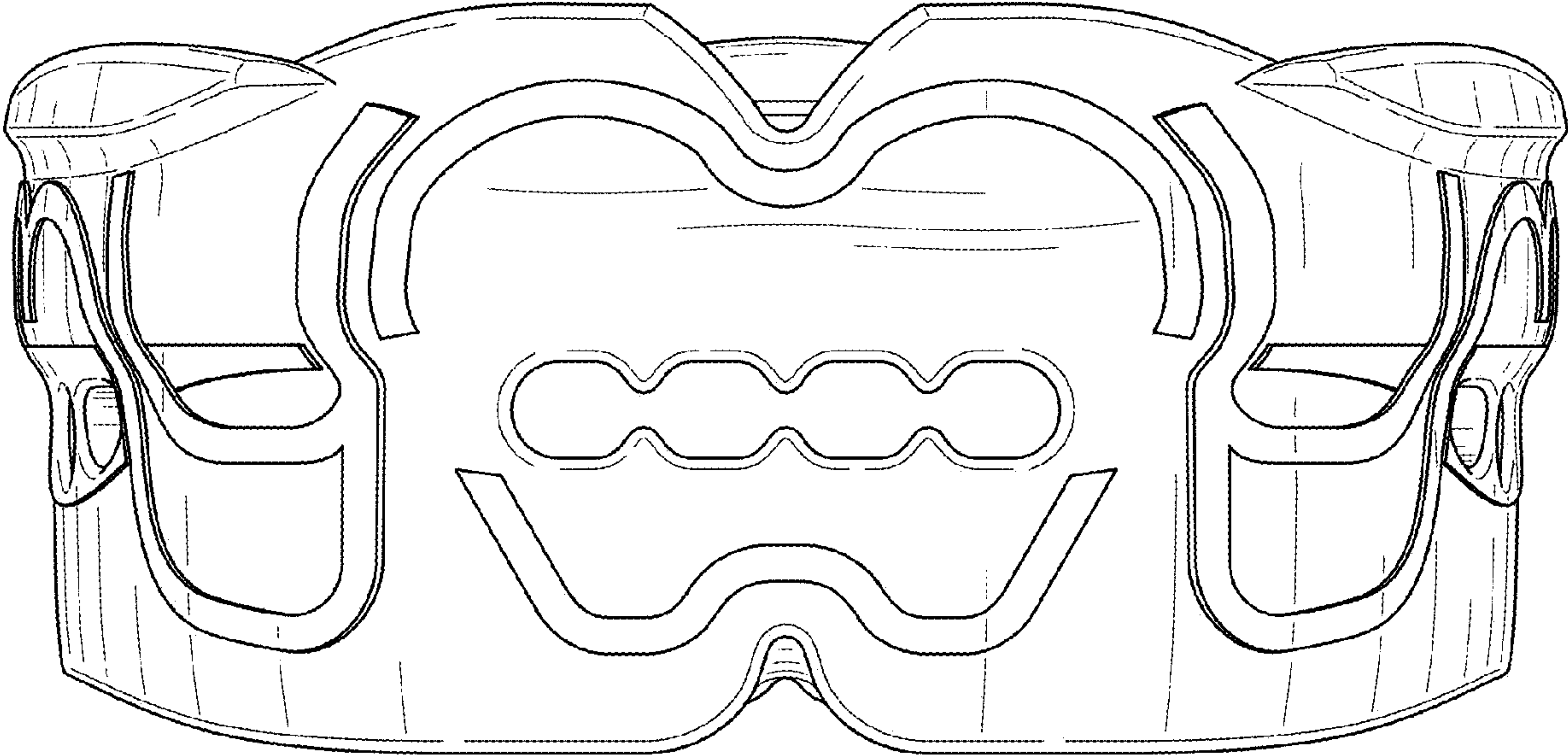

FIG. 3

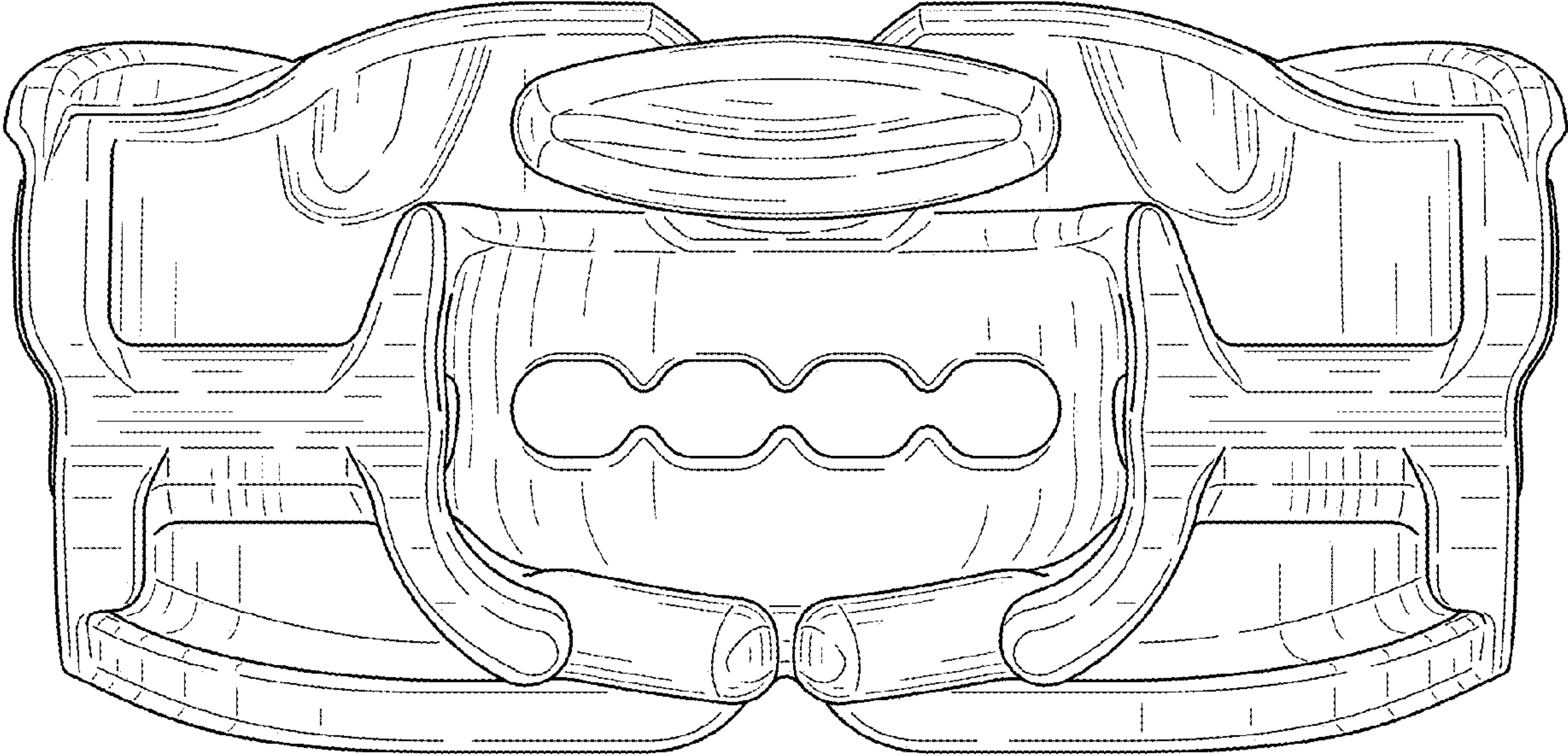

FIG. 4

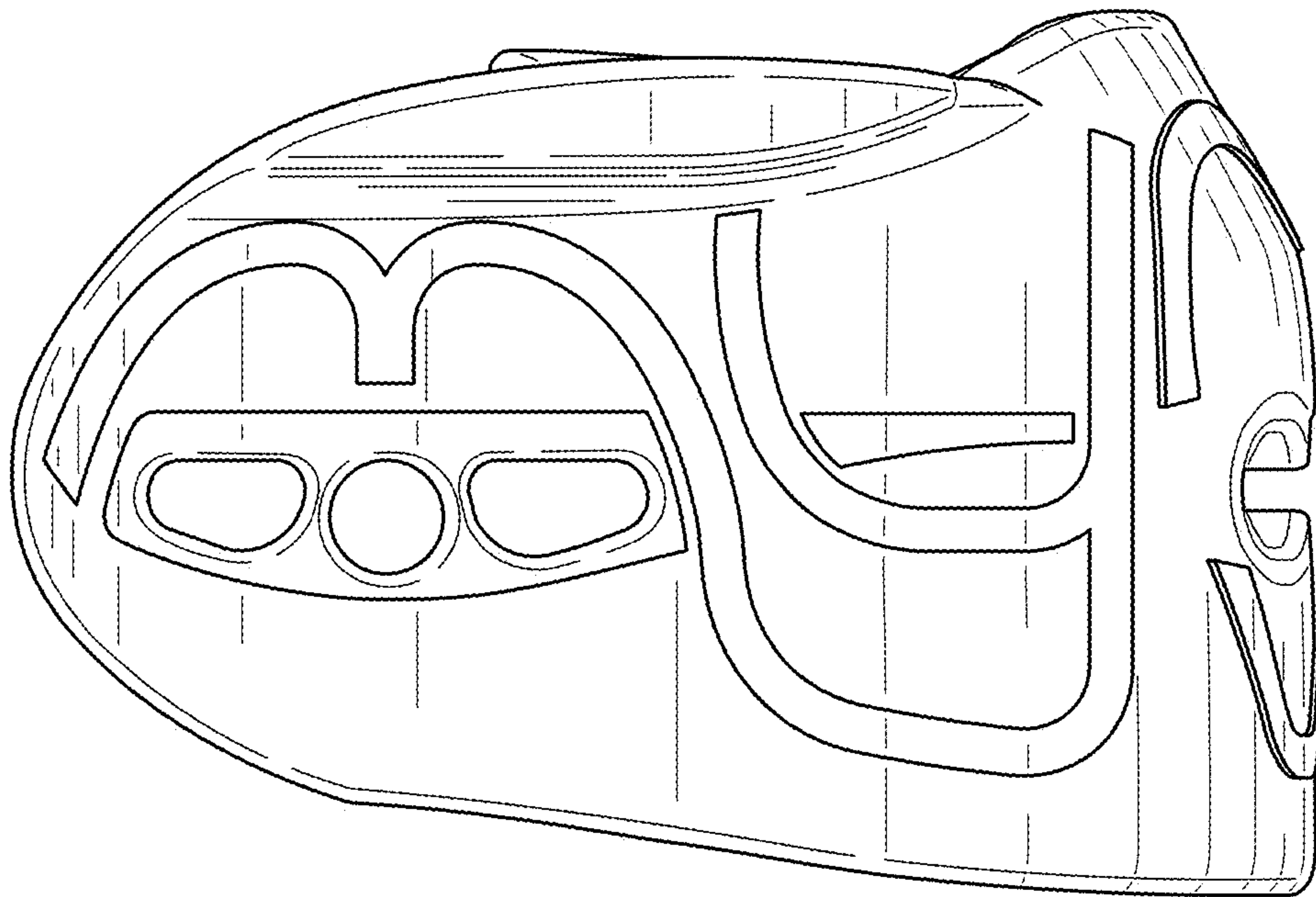

FIG. 5

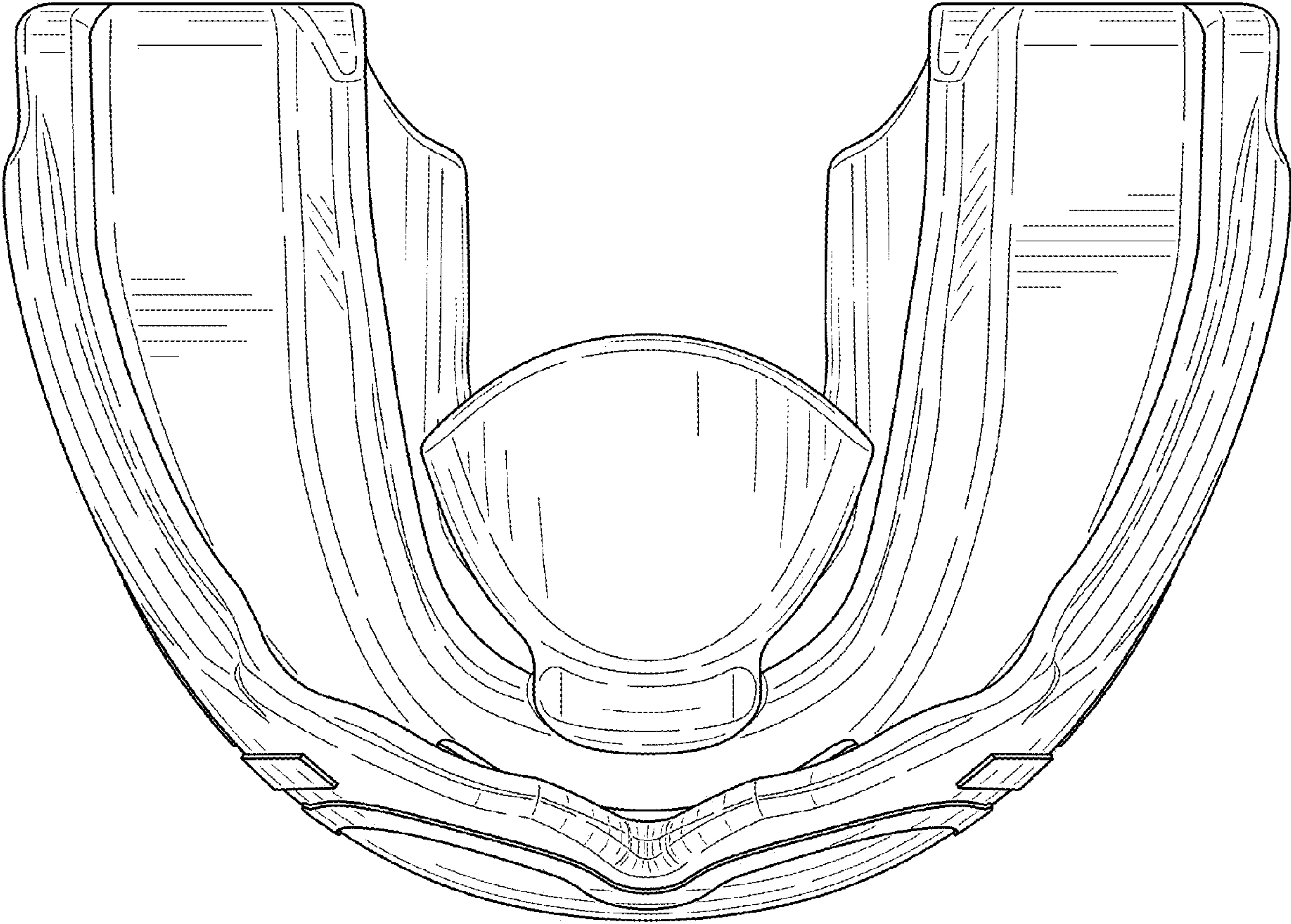

FIG. 6

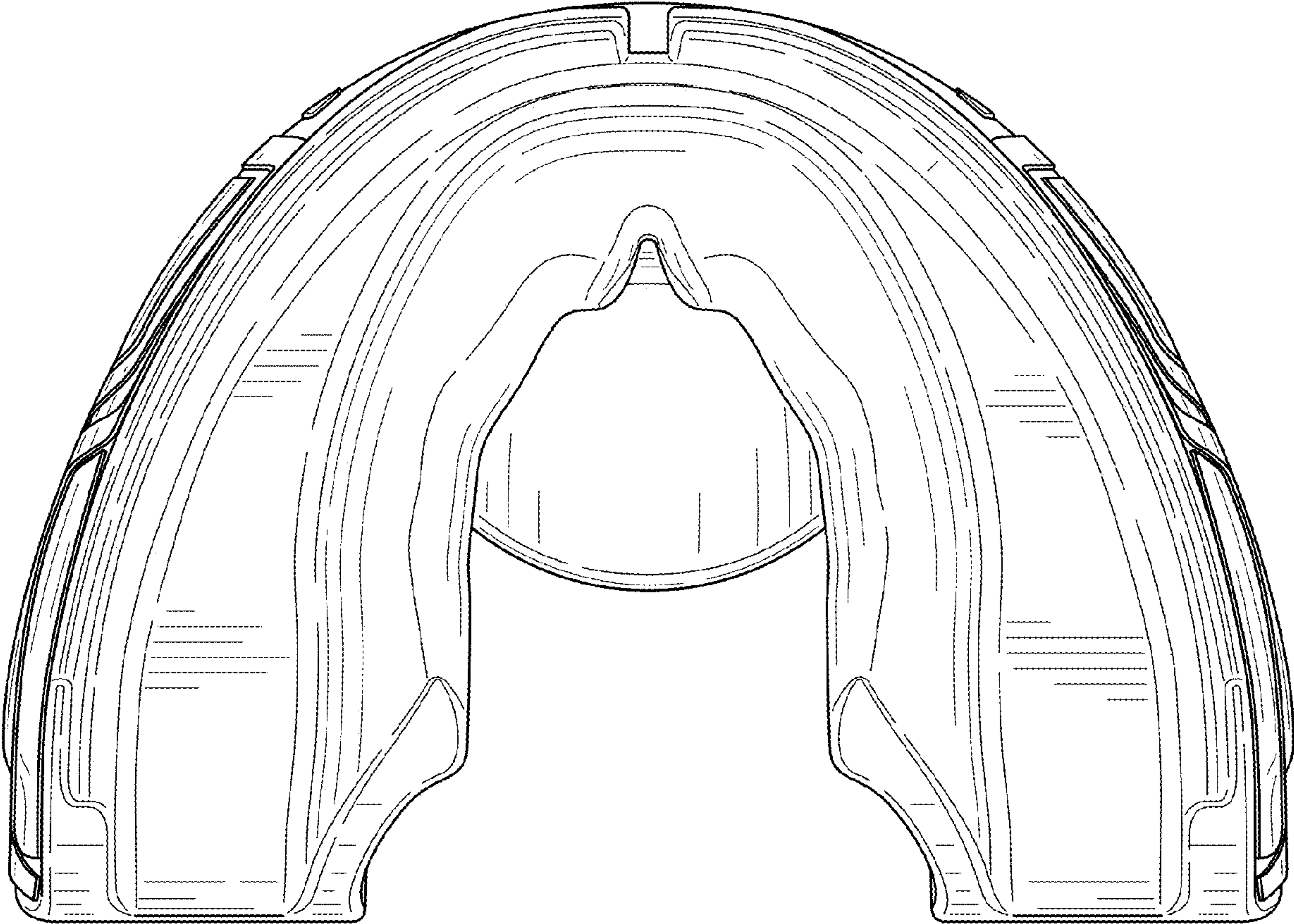

FIG. 7

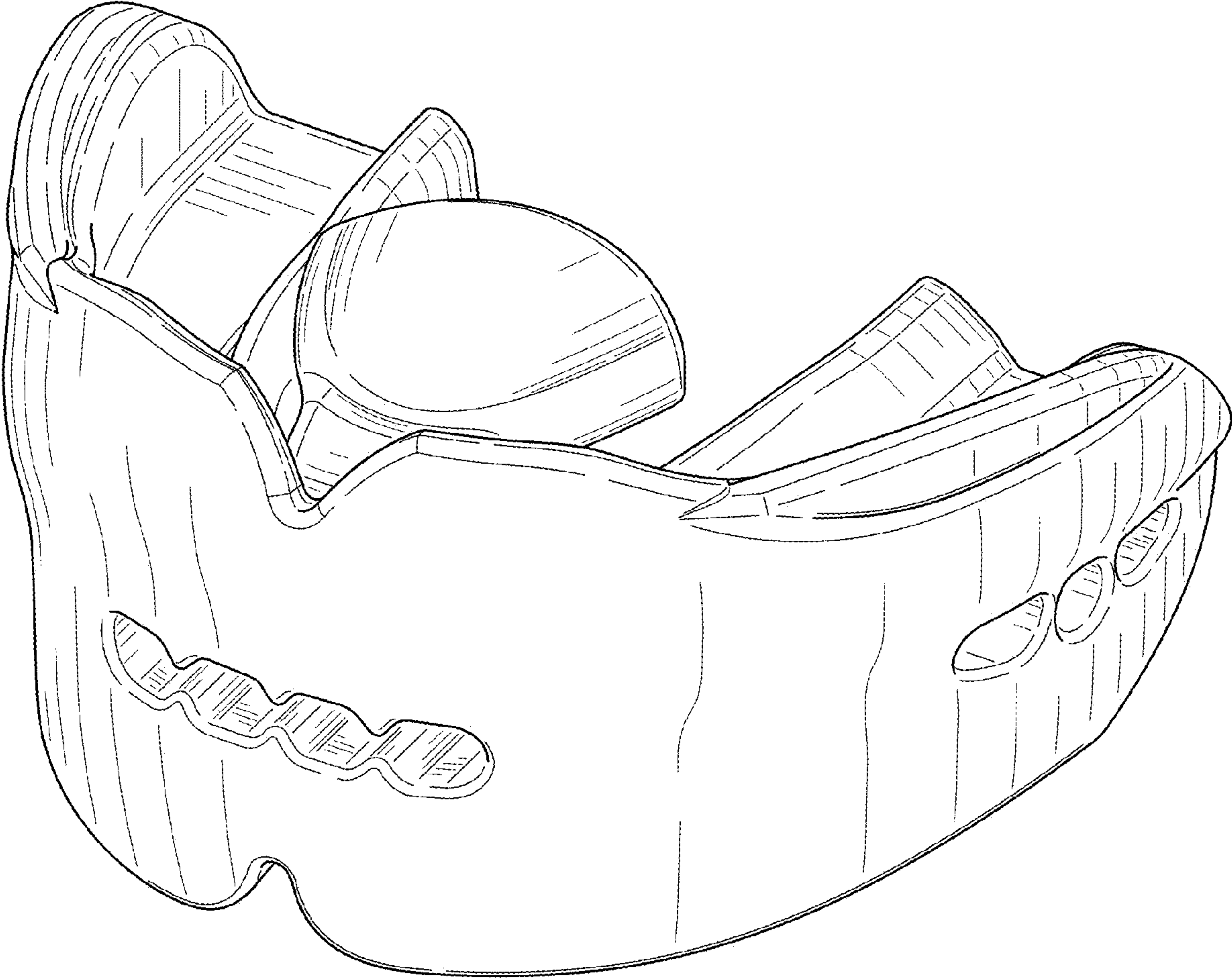

FIG. 8

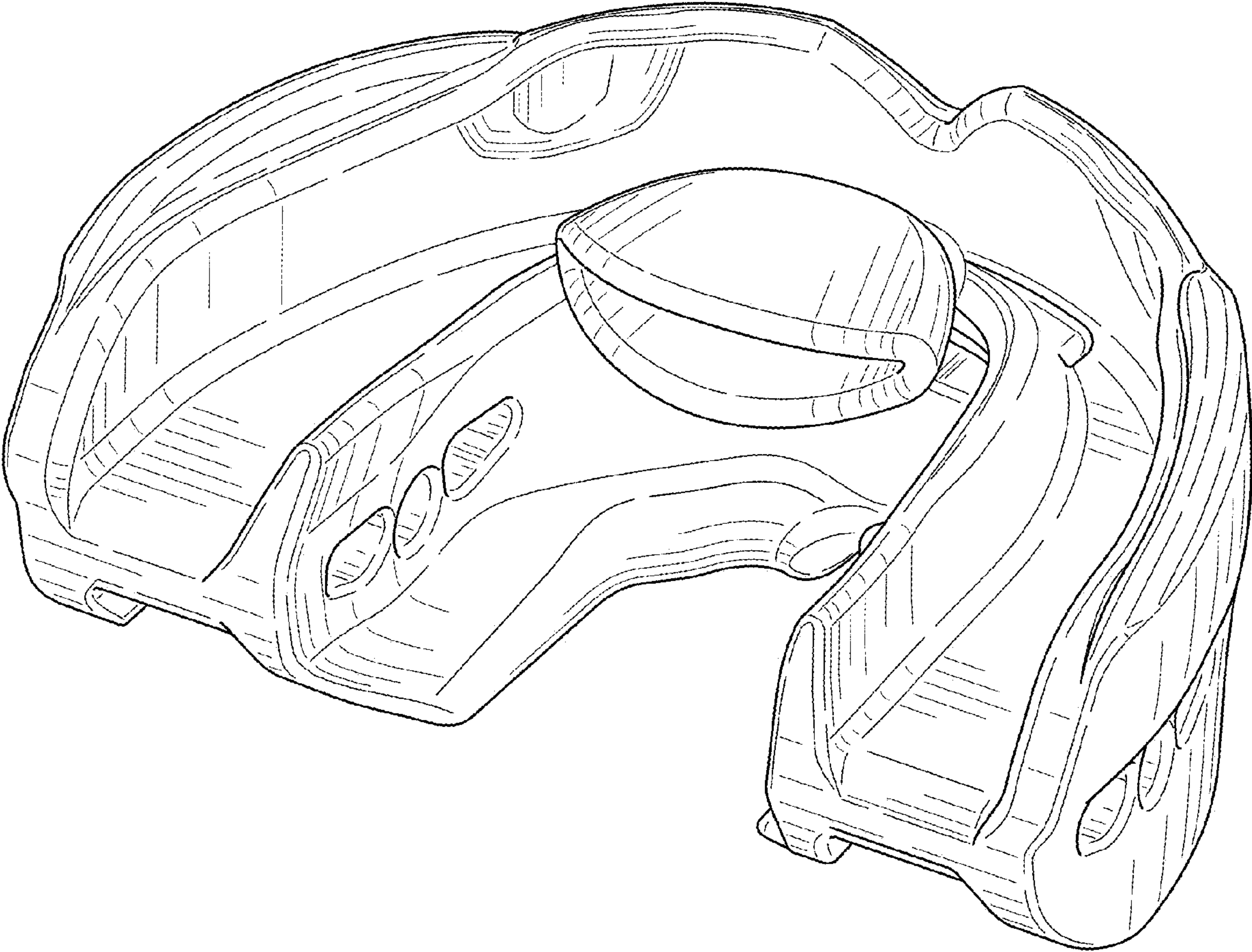

FIG. 9

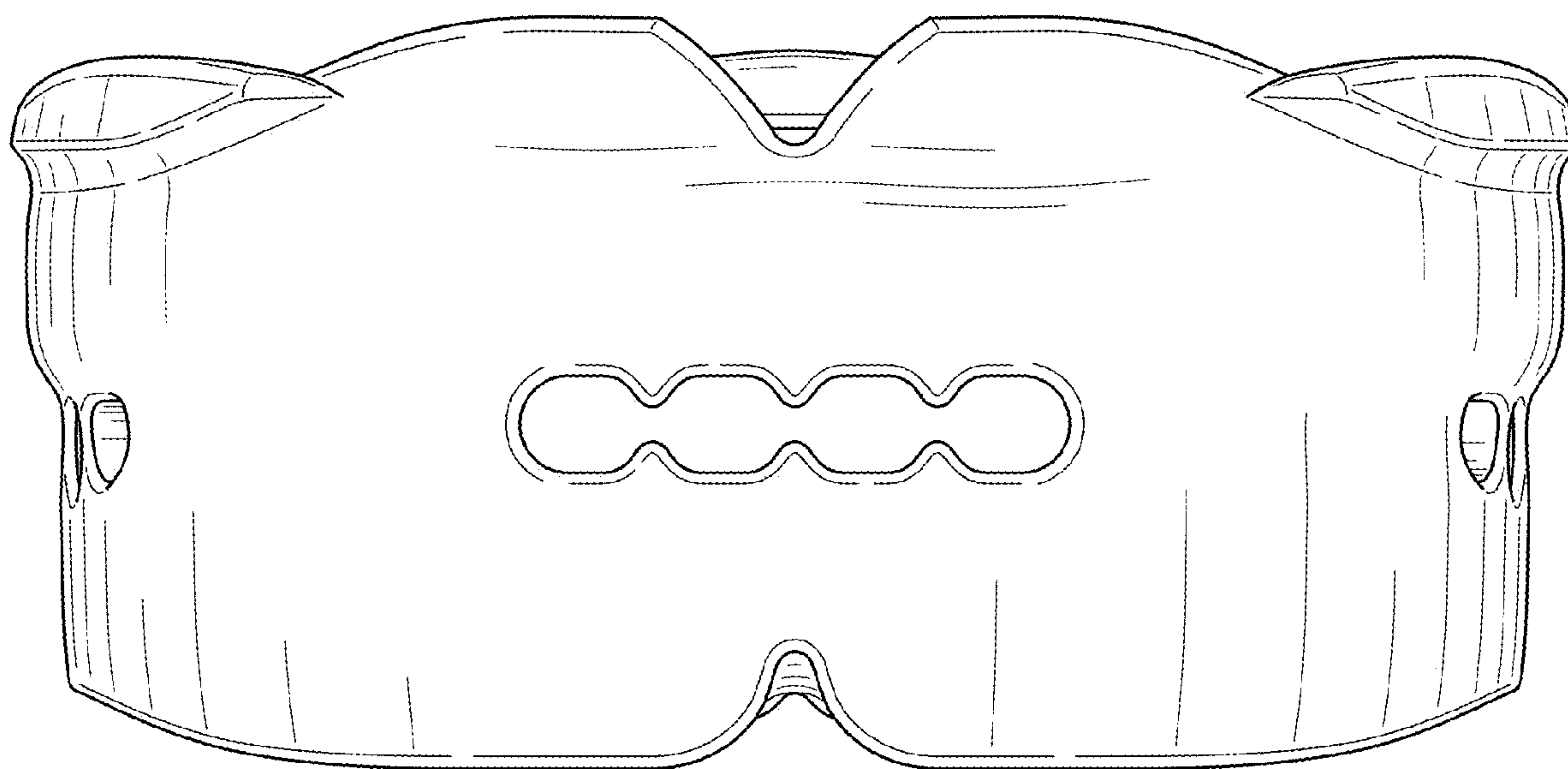

FIG. 10

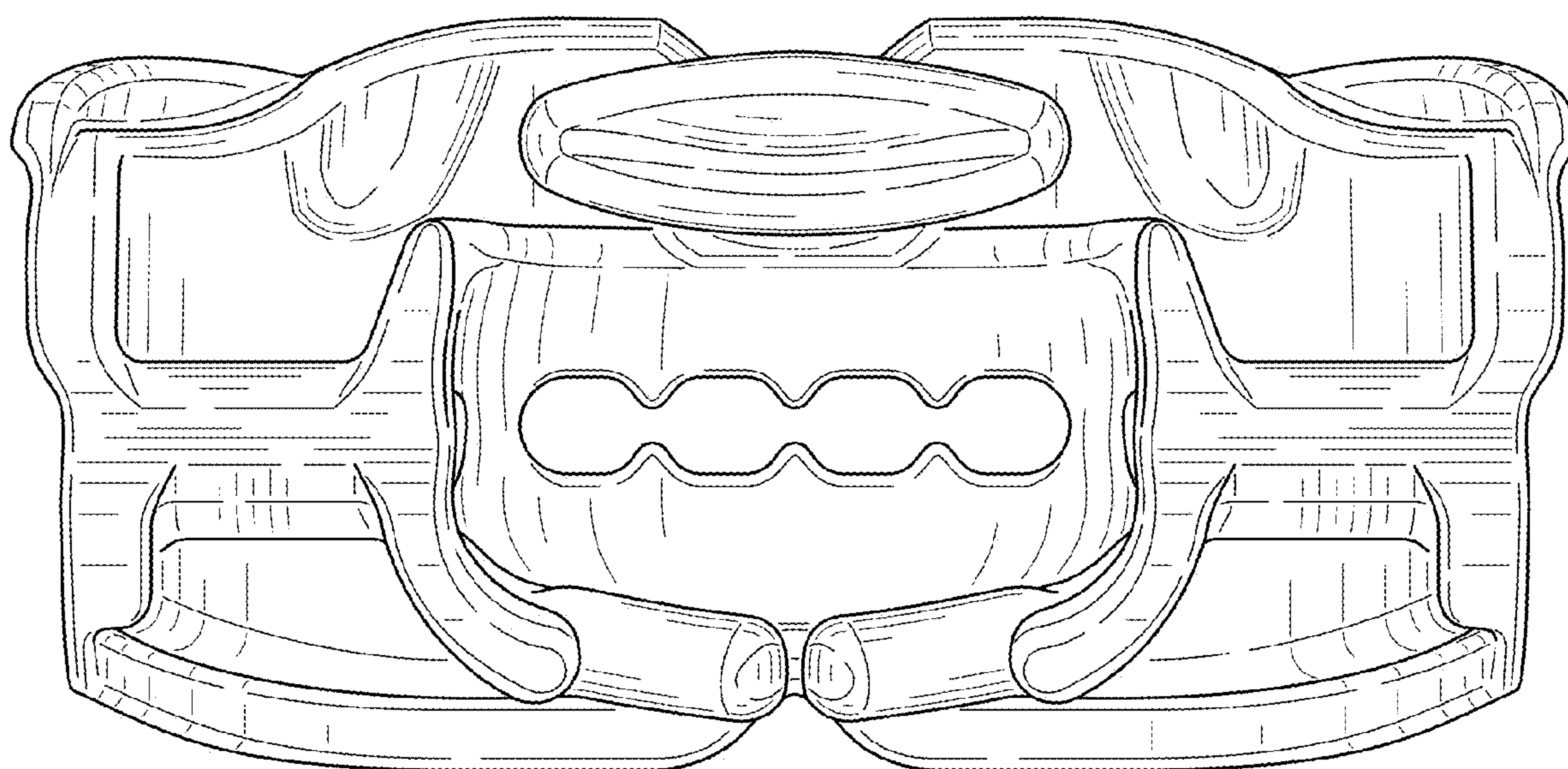

FIG. 11

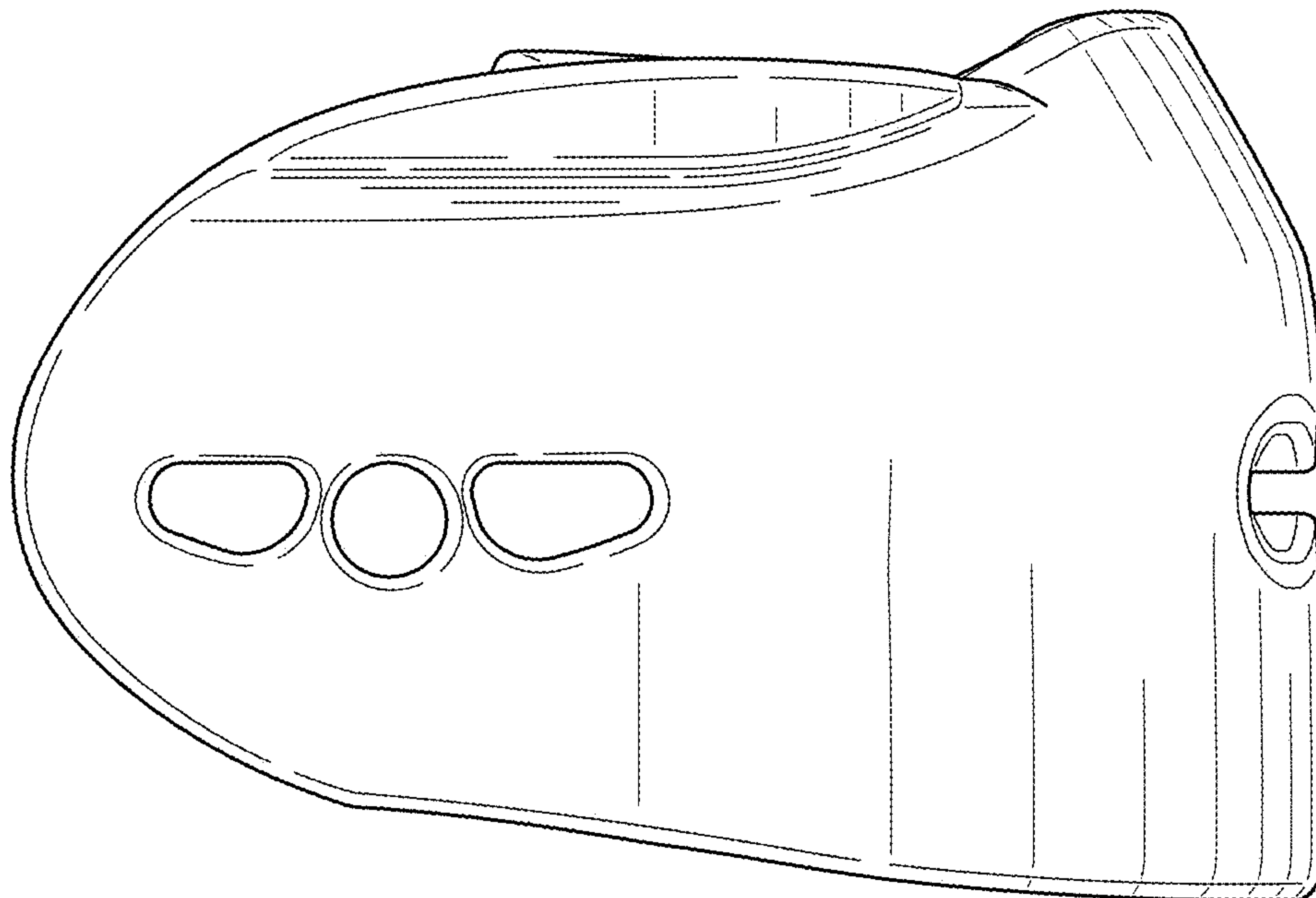

FIG. 12

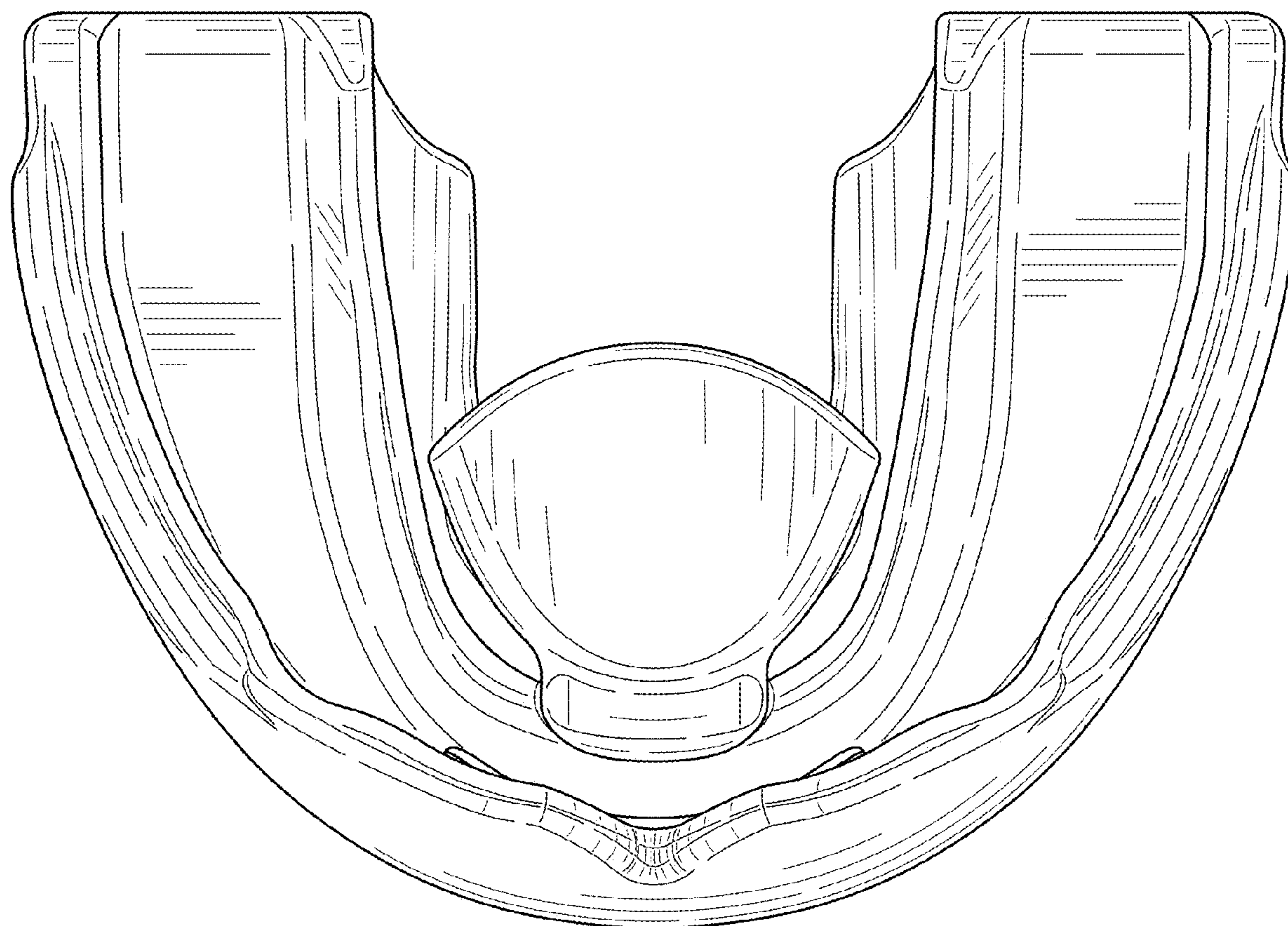

FIG. 13

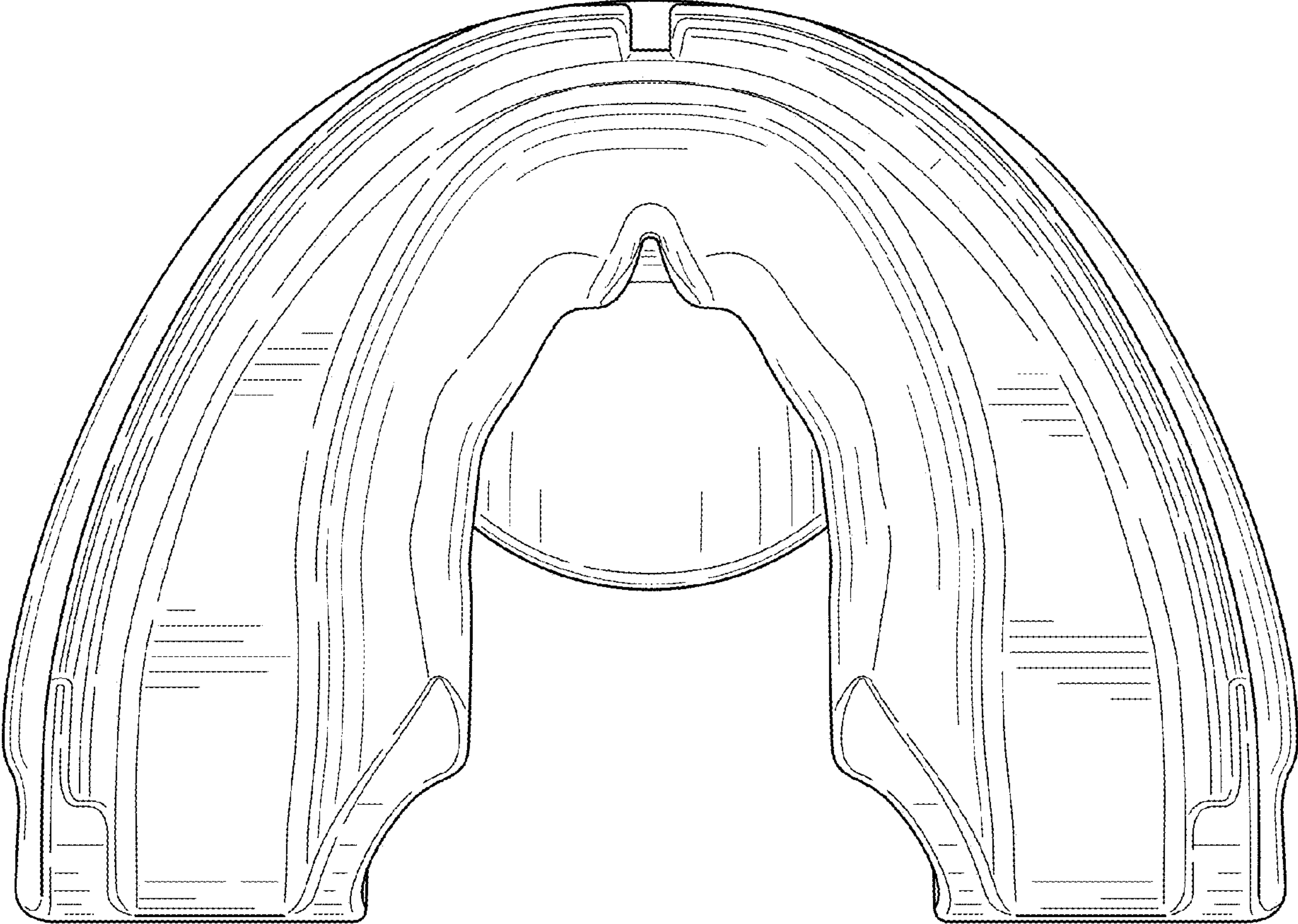

FIG. 14