



US00D903049S

(12) **United States Design Patent** (10) **Patent No.:** **US D903,049 S**
Farley (45) **Date of Patent:** **** Nov. 24, 2020**

(54) **FILTERED SHOWERHEAD WITH MULTIPLE NOZZLE ASSEMBLIES**

(71) Applicant: **David K. Farley**, Corona, CA (US)

(72) Inventor: **David K. Farley**, Corona, CA (US)

(**) Term: **15 Years**

(21) Appl. No.: **29/694,016**

(22) Filed: **Jun. 6, 2019**

(51) **LOC (12) Cl.** **23-01**

(52) **U.S. Cl.**
USPC **D23/213**

(58) **Field of Classification Search**
USPC D23/213, 214, 215, 223, 224, 226, 229, D23/230
CPC A61H 9/0021; A61H 33/00; B05B 1/00; B05B 1/14; B05B 1/185; B05B 1/08; B05B 1/02; B05B 1/26; B05B 12/002; B05B 1/18; B05B 9/01

See application file for complete search history.

(56) **References Cited**

U.S. PATENT DOCUMENTS

D608,412 S *	1/2010	Barnard	D23/223
D608,413 S *	1/2010	Barnard	D23/223
D629,867 S *	12/2010	Rexach	D23/213
D673,649 S *	1/2013	Quinn	D23/213
D700,275 S *	2/2014	Ovans	D23/213
D758,543 S *	6/2016	Greenwood	D23/235
D758,544 S *	6/2016	Greenwood	D23/235
D783,129 S *	4/2017	Edwards	D23/235
D783,130 S *	4/2017	Edwards	D23/235
D792,944 S *	7/2017	Cheng	D23/224
D792,945 S *	7/2017	Cheng	D23/224
D799,007 S *	10/2017	Cheng	D23/223
D810,234 S *	2/2018	Winter	D23/213
10,518,201 B2 *	12/2019	Farley	B05B 1/1636
2019/0184316 A1 *	6/2019	Farley	B05B 9/01

OTHER PUBLICATIONS

https://www.amazon.com/Kohler-K-15996-CP-multifunction-wall-mount-Showerhead/dp/B003ULNSRI/ref=sr_1_170?dchild=1

&keywords=pivoting%2Bshower%2Bhead&qid=1588189549&sr=8-170&swrs=AF5B754DFF2FAA8BDA238ACC35626D8C&th=1 (Year: 2010).*

* cited by examiner

Primary Examiner — Manpreet S Matharu

Assistant Examiner — Keith J Wilson

(74) *Attorney, Agent, or Firm* — Klein, O'Neill & Singh, LLP

(57) **CLAIM**

The ornamental design for a filtered showerhead with multiple nozzle assemblies, as shown and described.

DESCRIPTION

FIG. 1 is a perspective view of a first embodiment of the present invention, looking from the top of the filtered showerhead with multiple nozzle assemblies, showing my new design having a partial bridge around a movable nozzle assembly;

FIG. 2 is a perspective view taken from the bottom of FIG. 1;

FIG. 3 is a left side view of FIG. 1; the right side being a mirror image thereof;

FIG. 4 is a bottom plan view of FIG. 1;

FIG. 5 is a top plan view of FIG. 1;

FIG. 6 is a rear elevational view of FIG. 1;

FIG. 7 is a front elevational view of FIG. 1;

FIG. 8 is a perspective view of a second embodiment of the present invention, having a full bridge surrounding a movable nozzle assembly, looking from the top of the filtered showerhead with multiple nozzle assemblies;

FIG. 9 is a bottom perspective view of FIG. 8;

FIG. 10 is a left side view of FIG. 8; the right side being a mirror image thereof;

FIG. 11 is a bottom plan view of FIG. 8;

FIG. 12 is a top plan view of FIG. 8;

FIG. 13 is a rear elevational view of FIG. 8; and,

FIG. 14 is a front elevational view of FIG. 8.

1 Claim, 10 Drawing Sheets

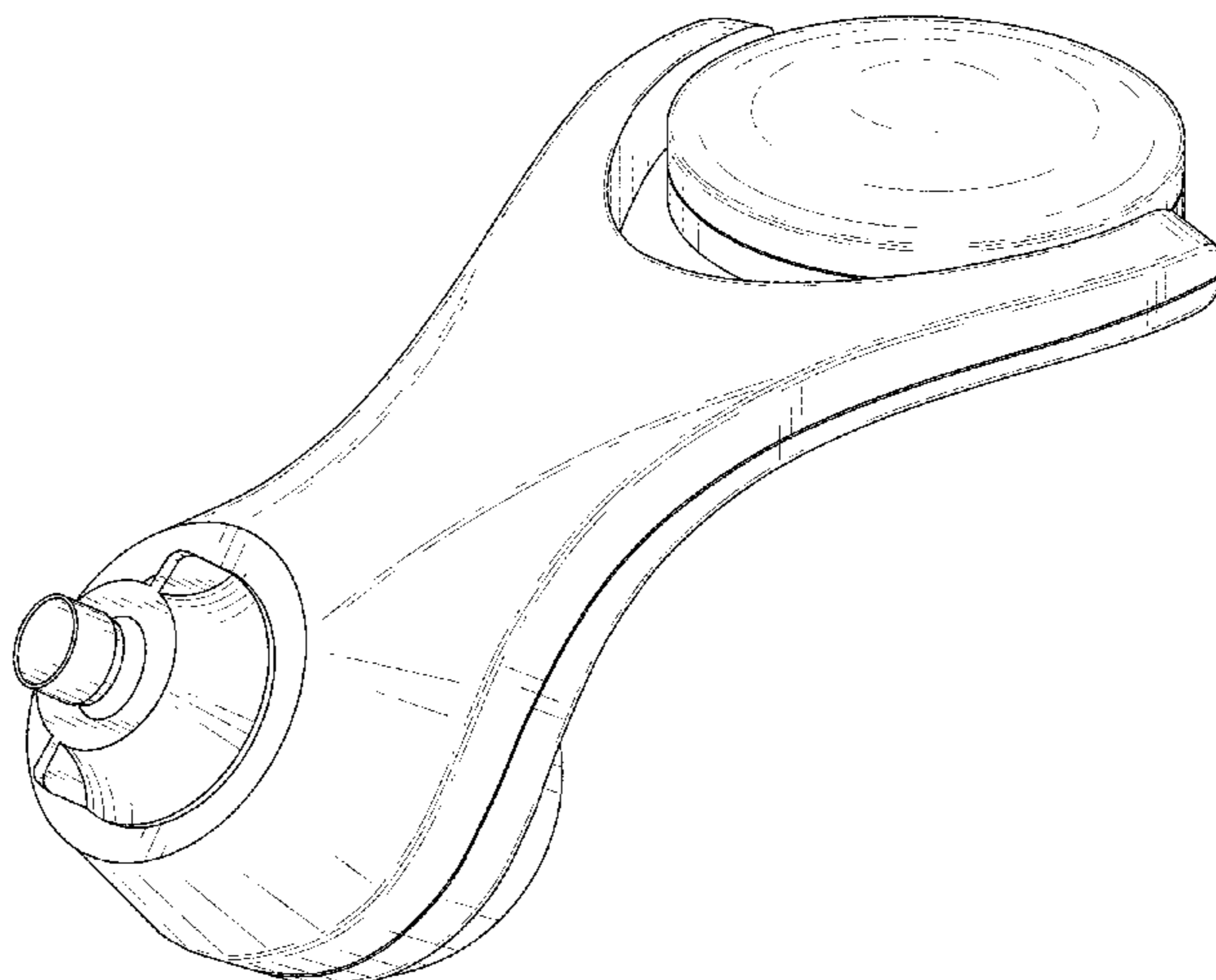

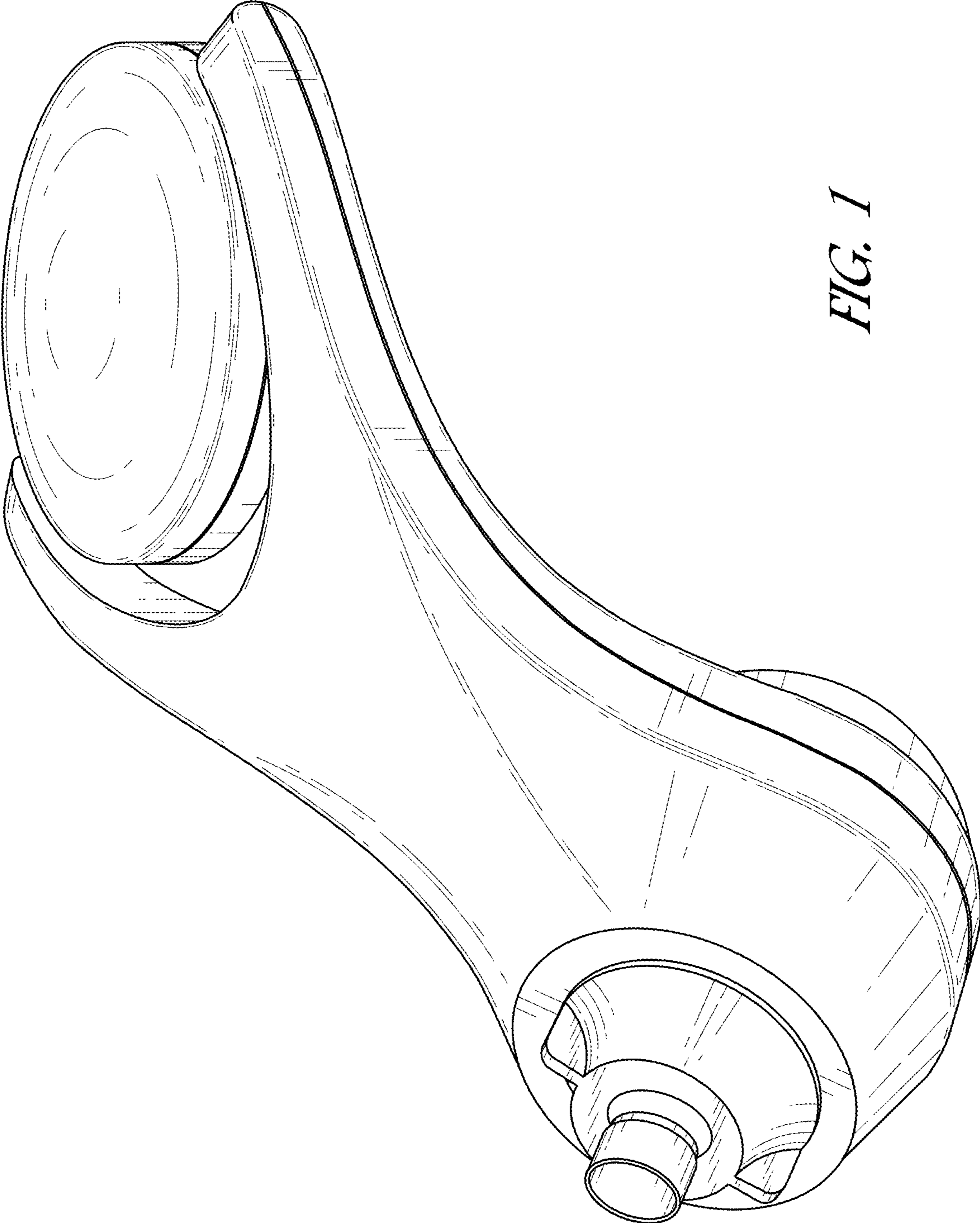

FIG. 1

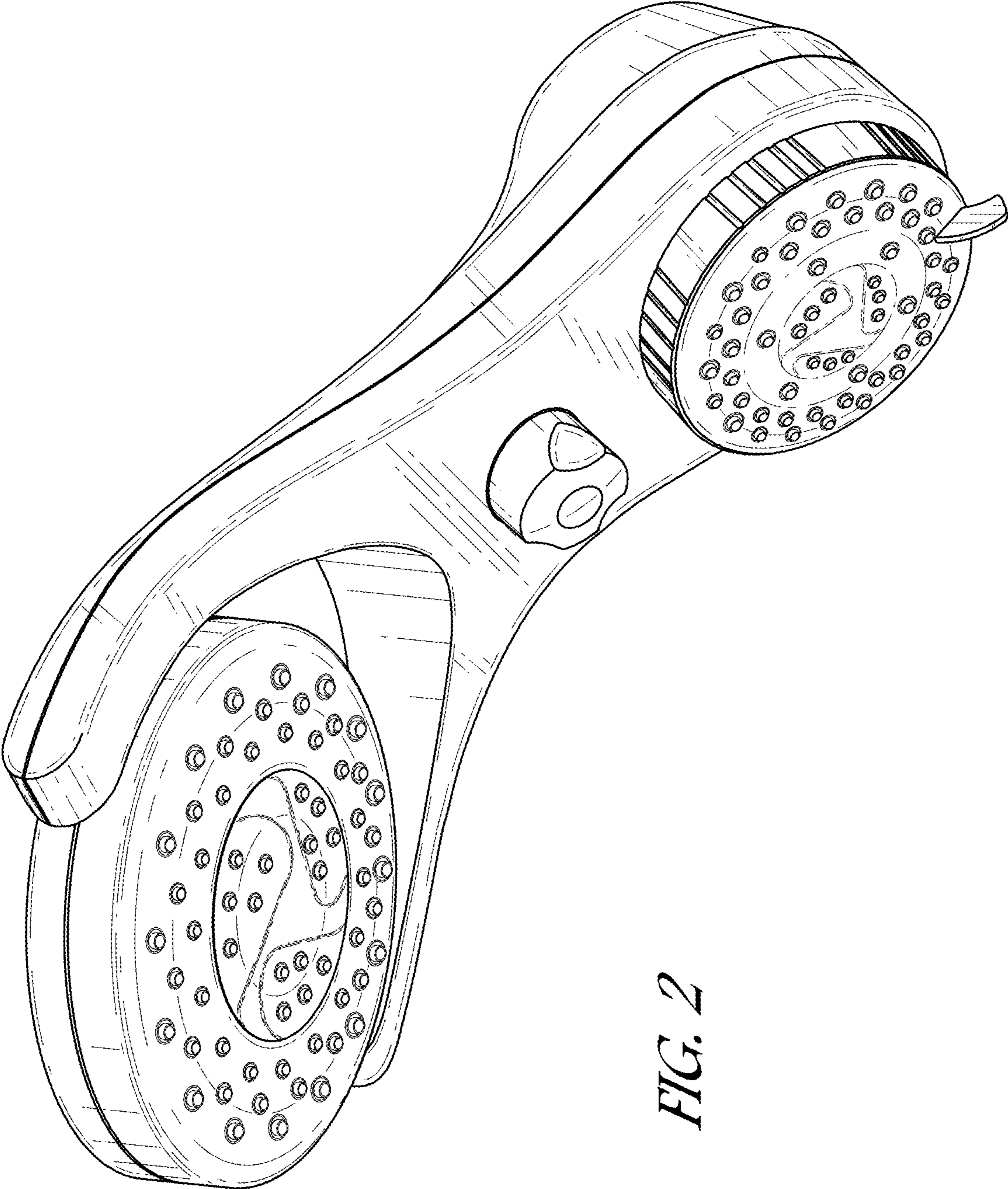

FIG. 2

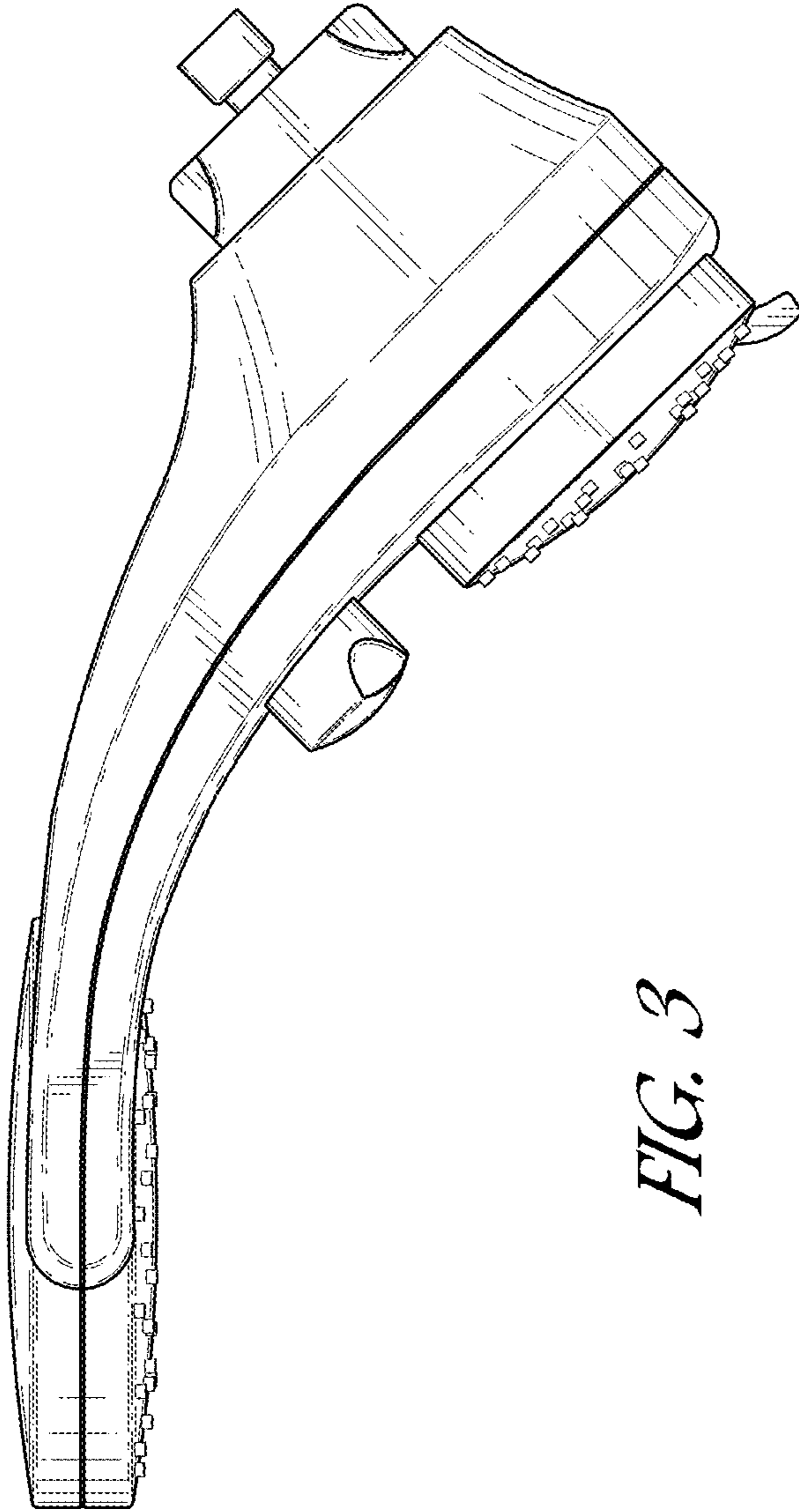

FIG. 3

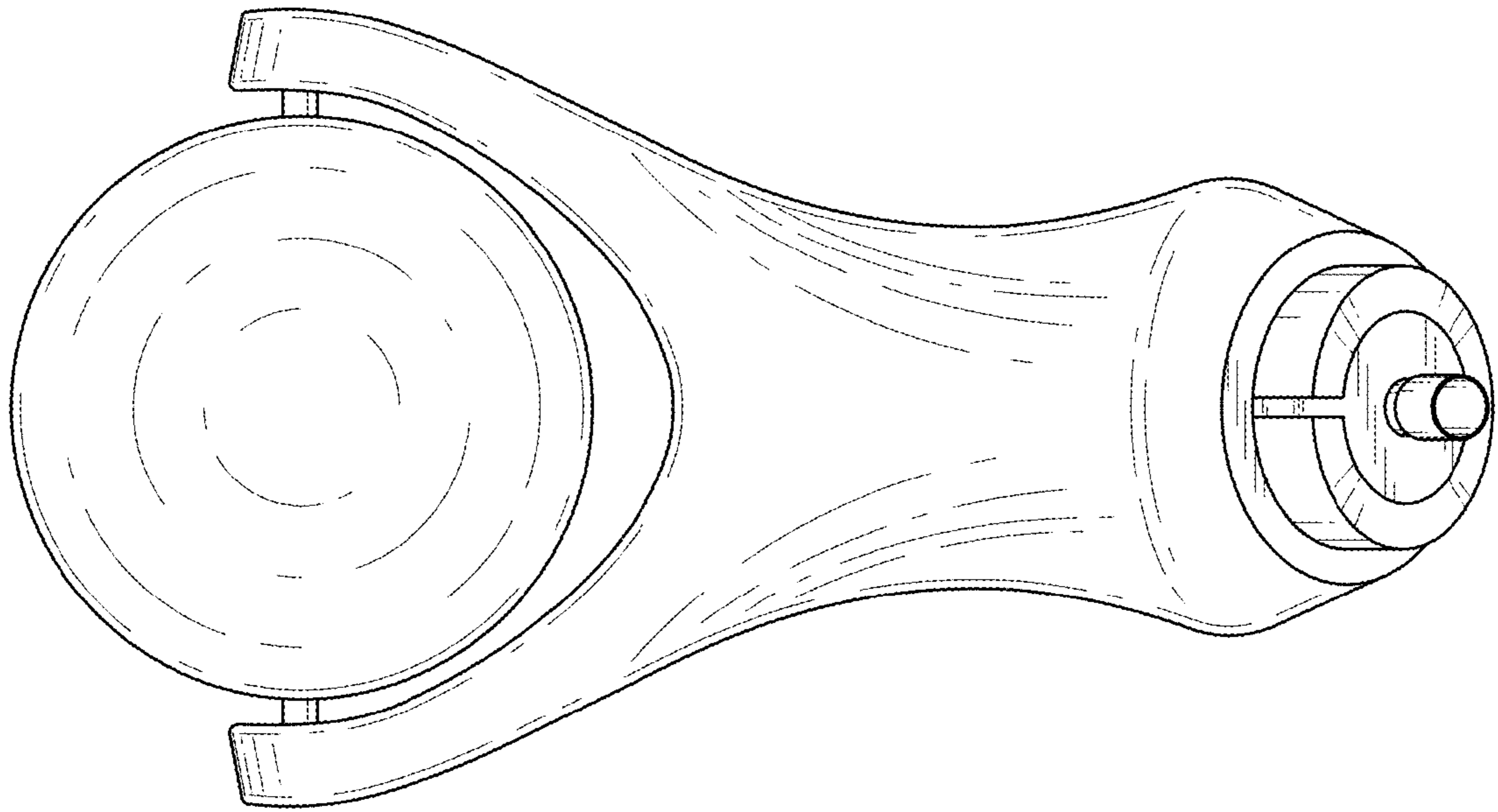

FIG. 5

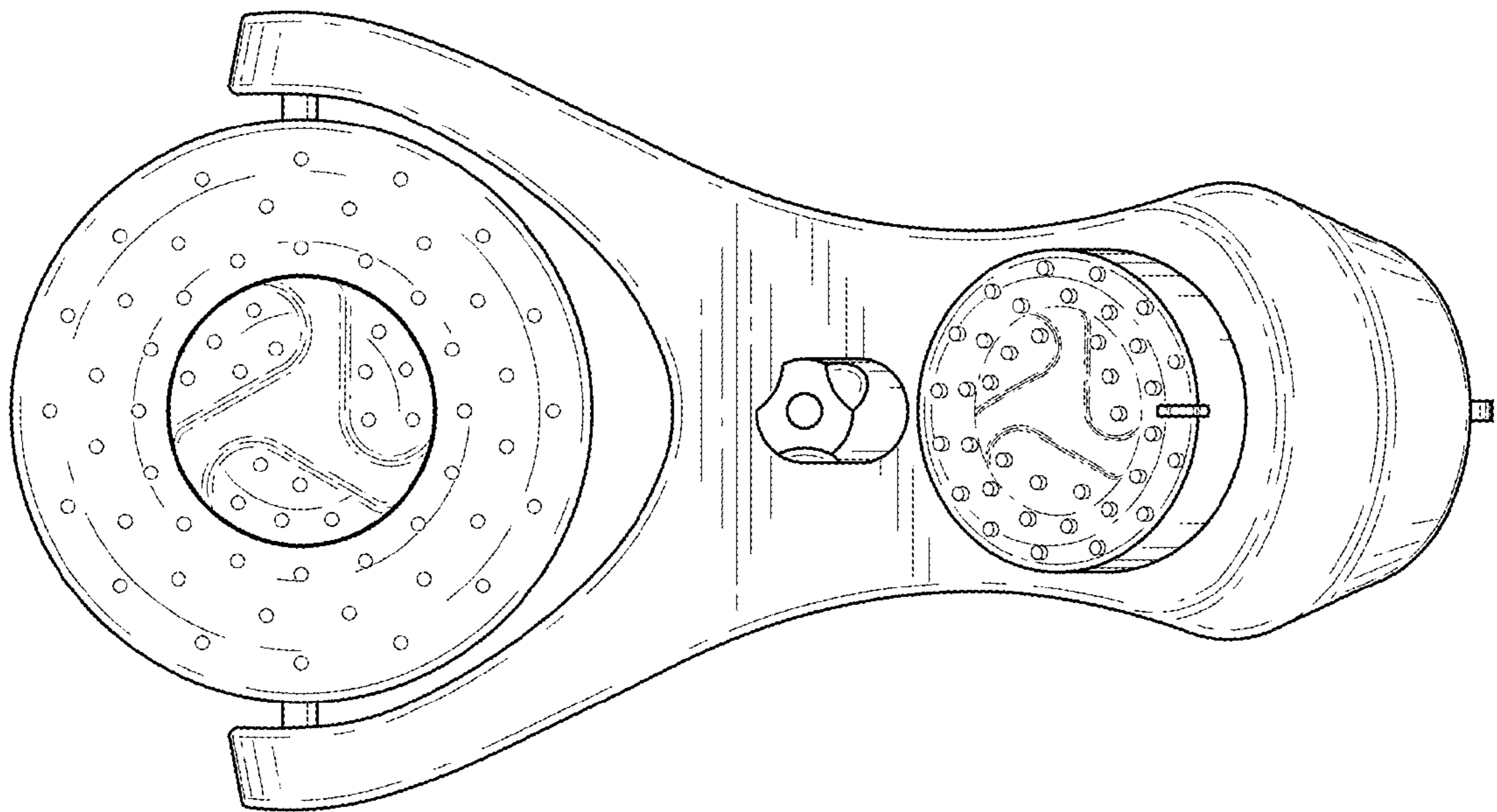

FIG. 4

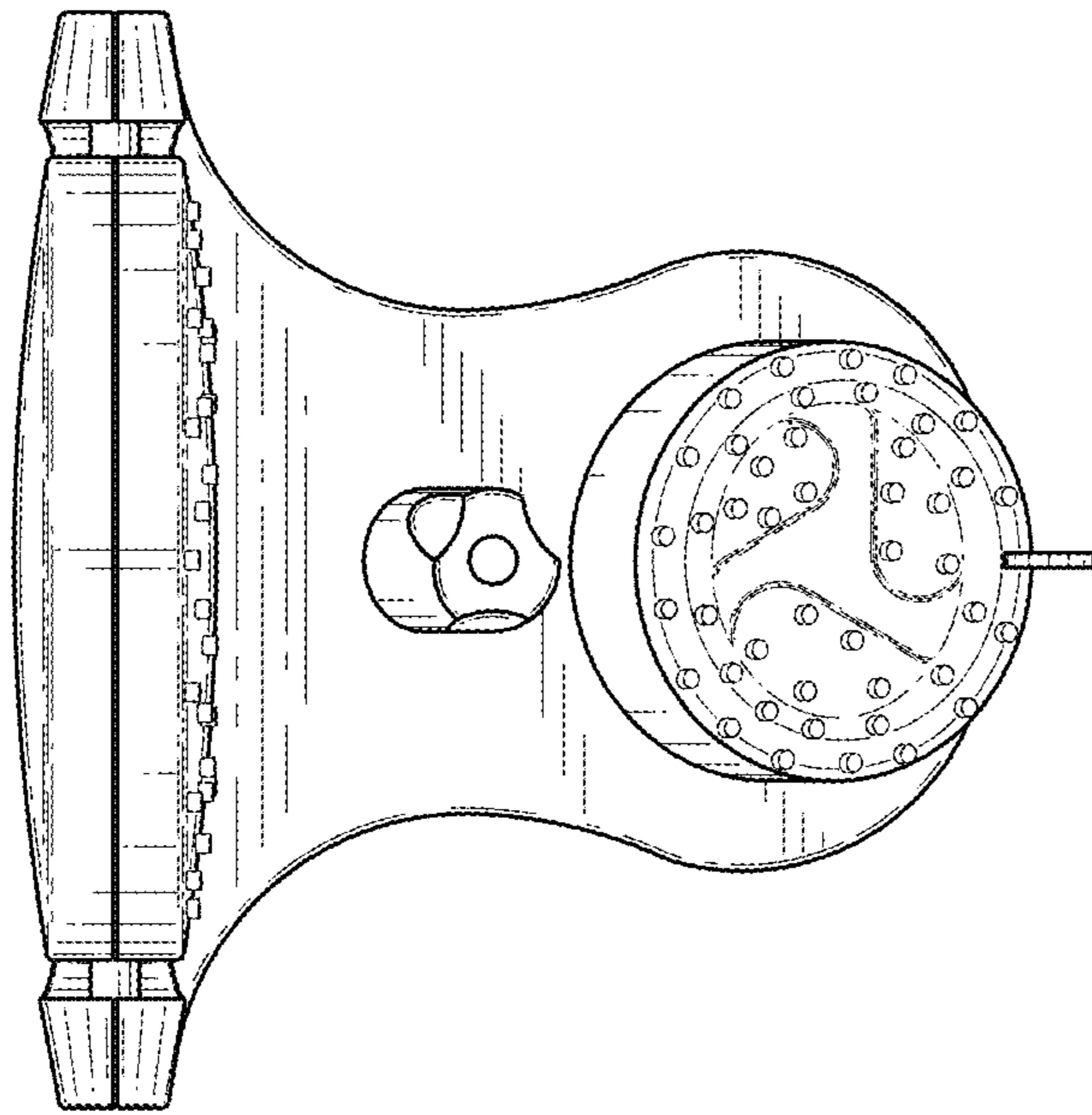

FIG. 7

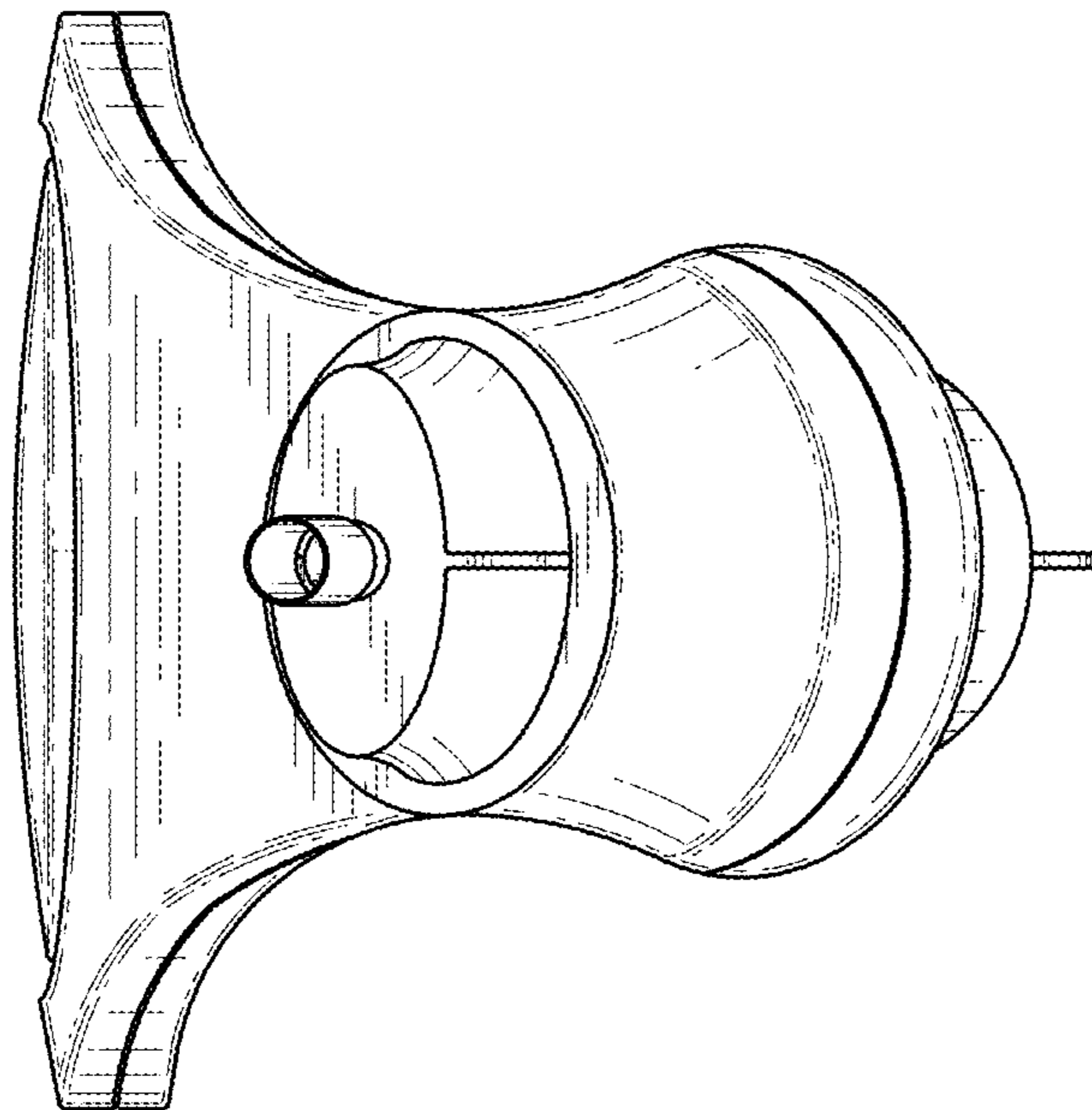

FIG. 6

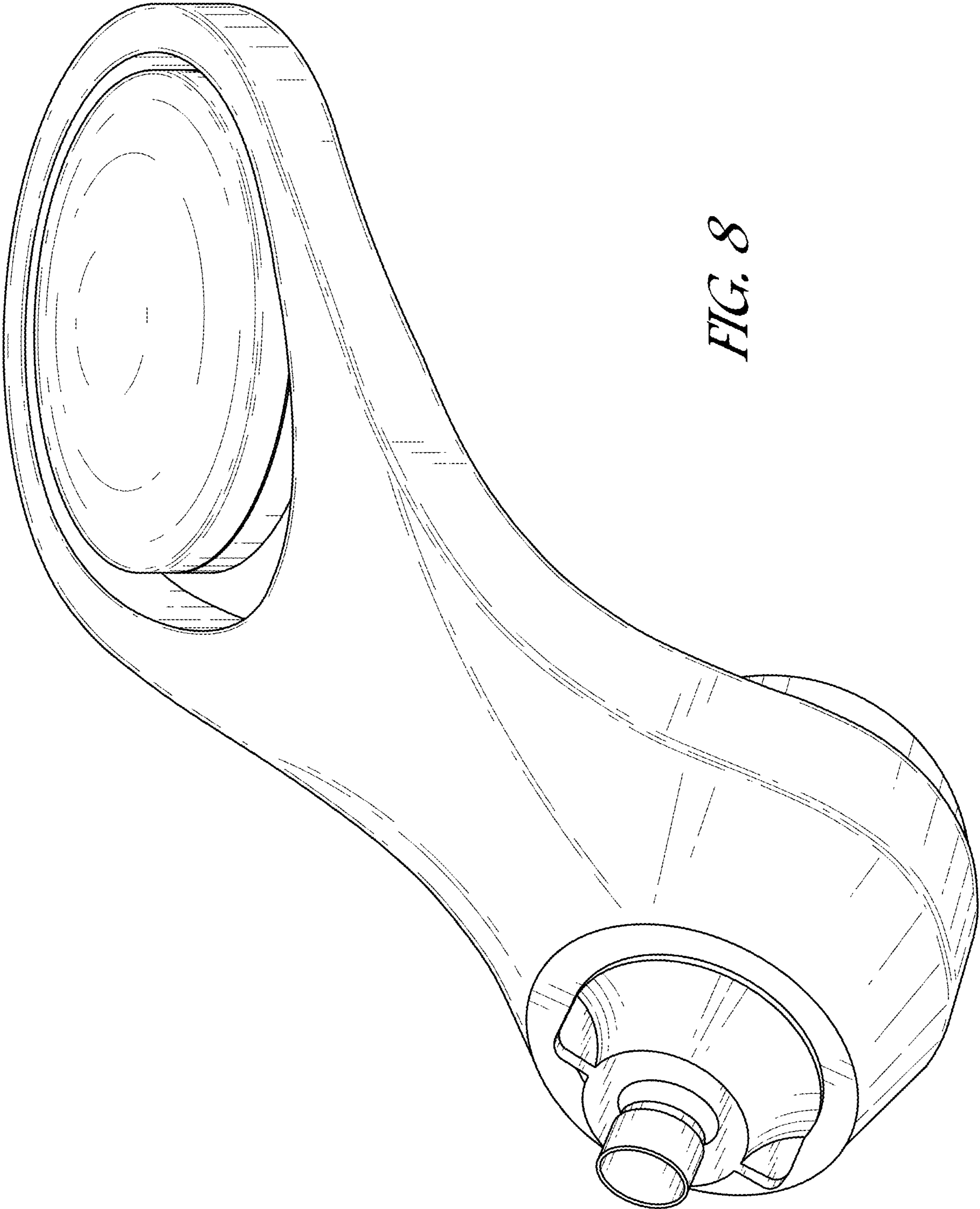

FIG. 8

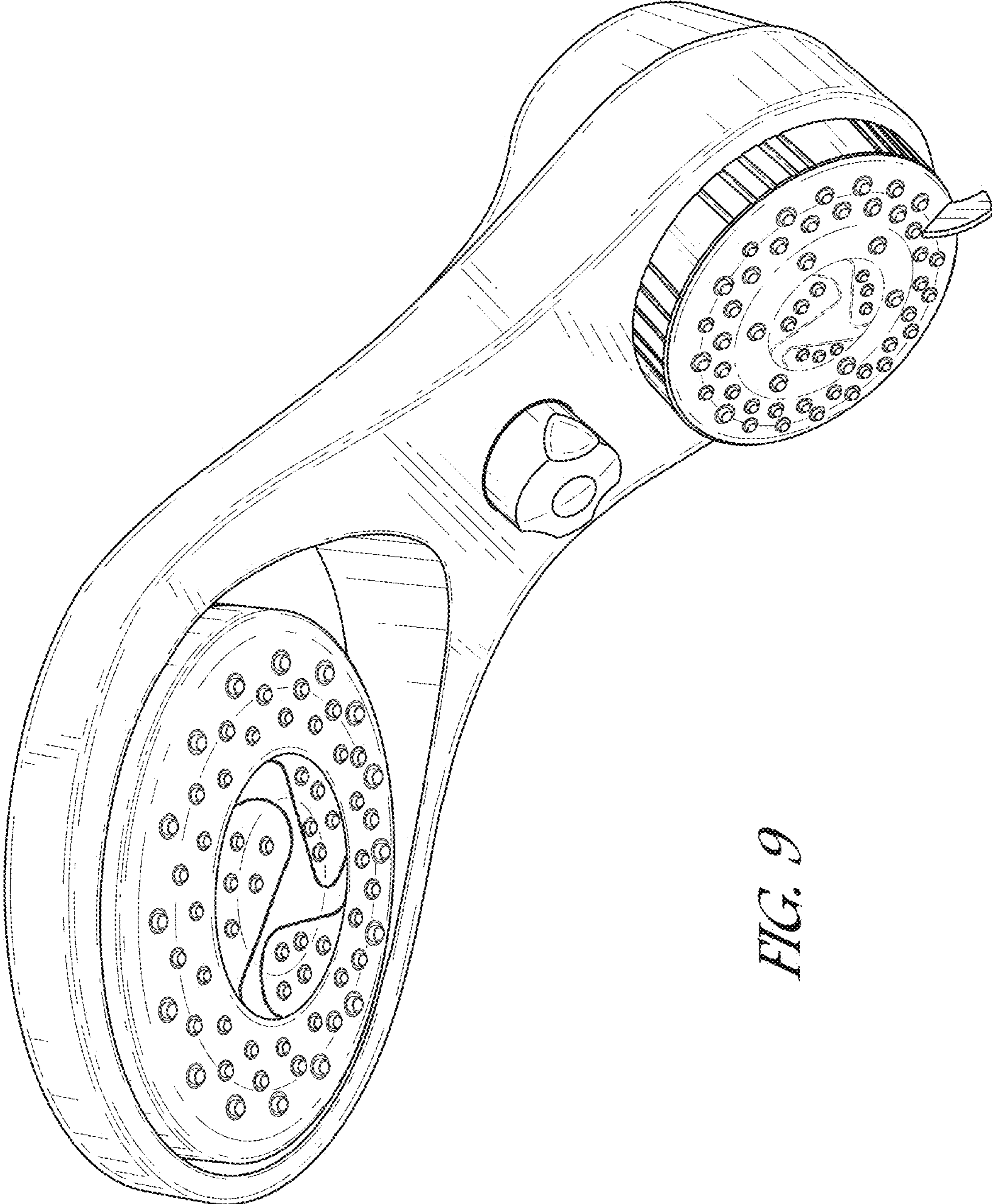

FIG. 9

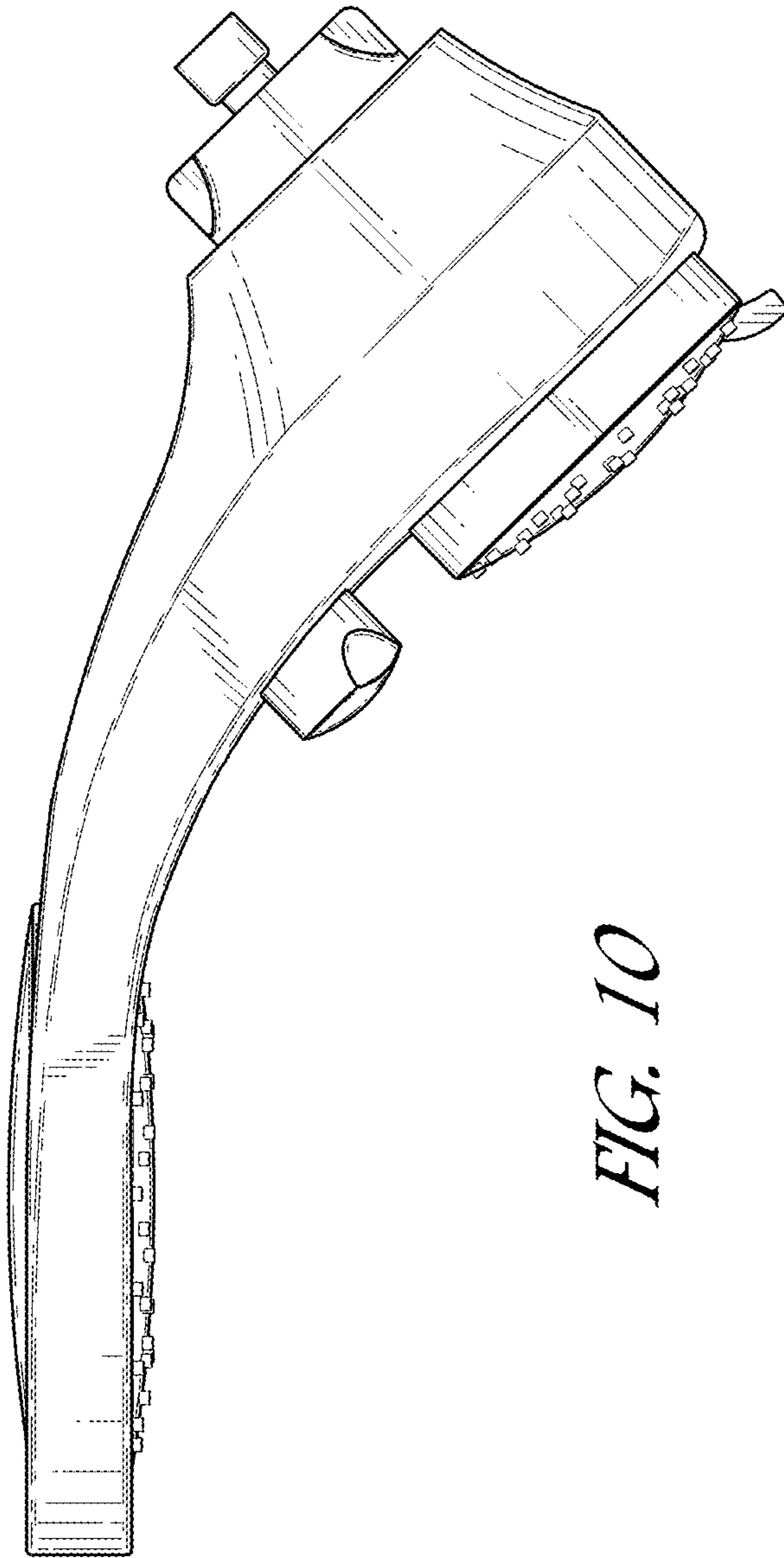

FIG. 10

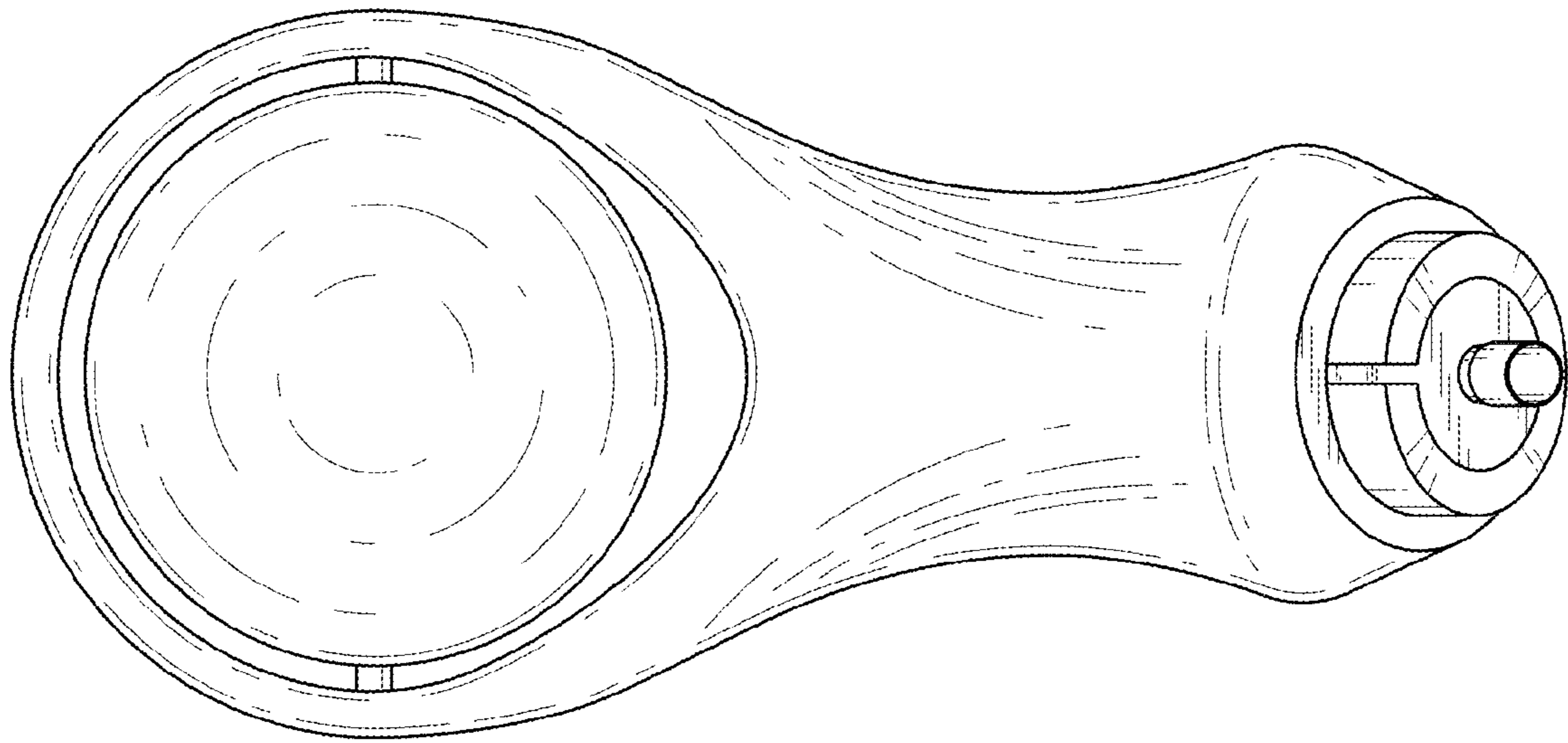

FIG. 12

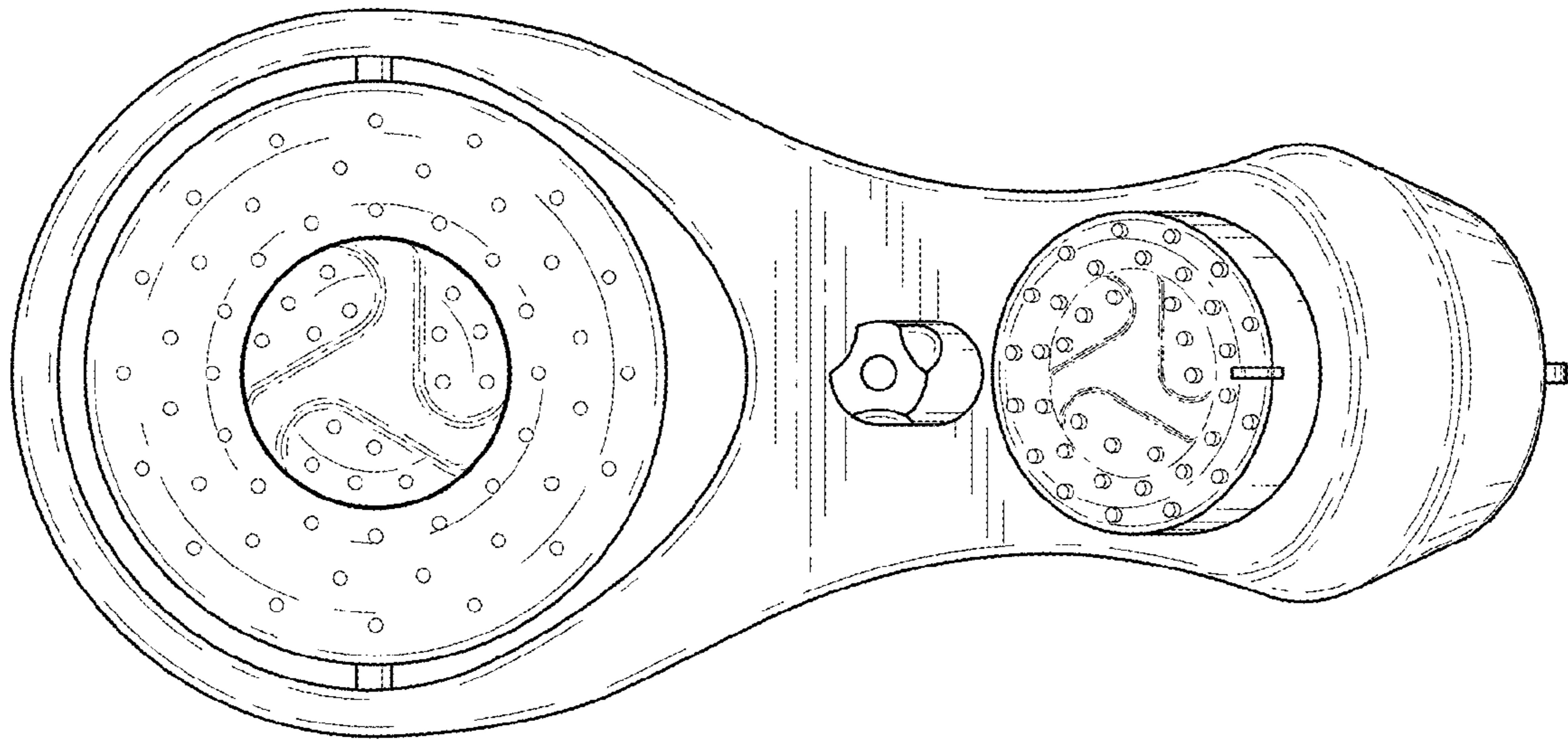

FIG. 11

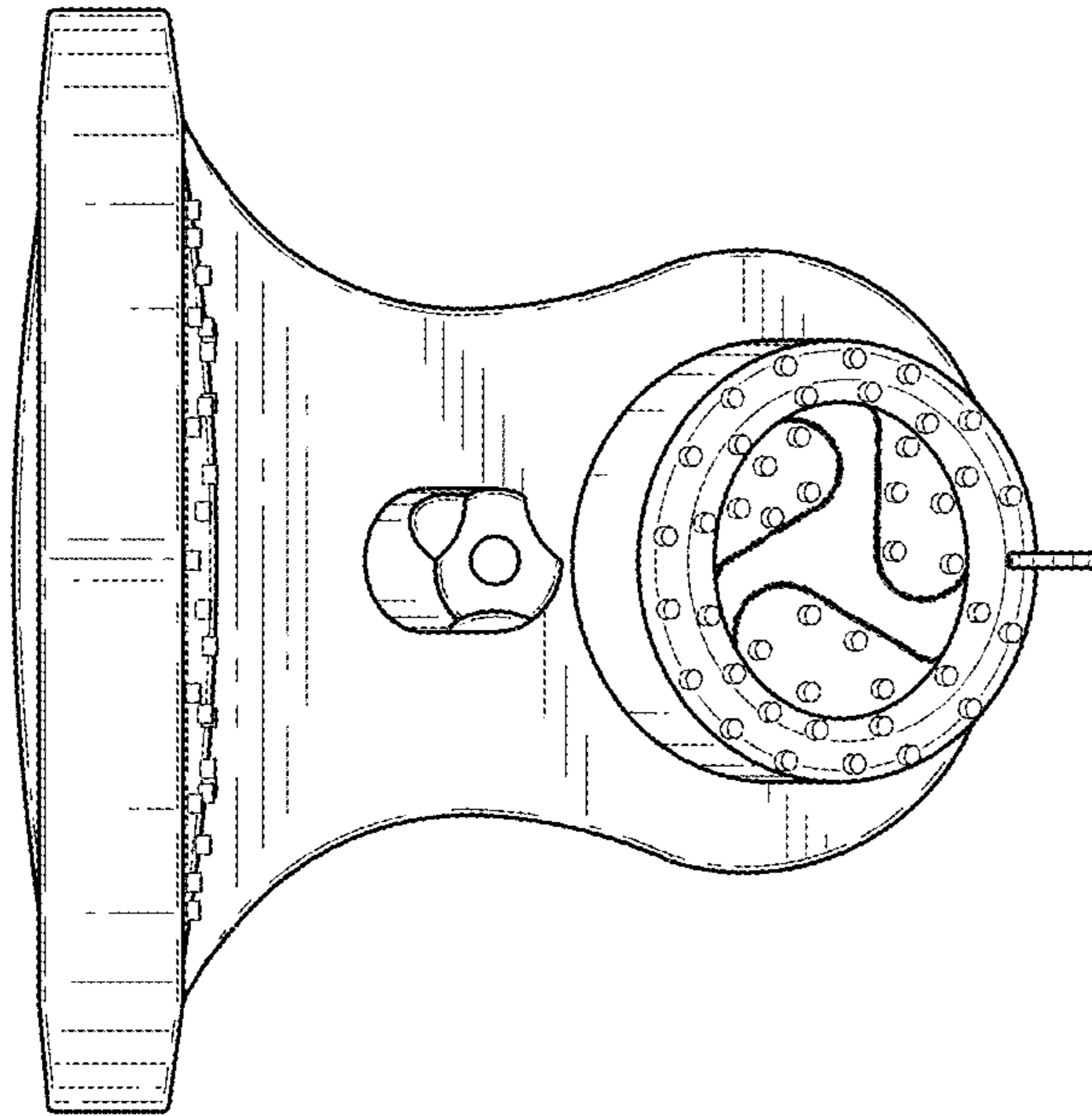

FIG. 14

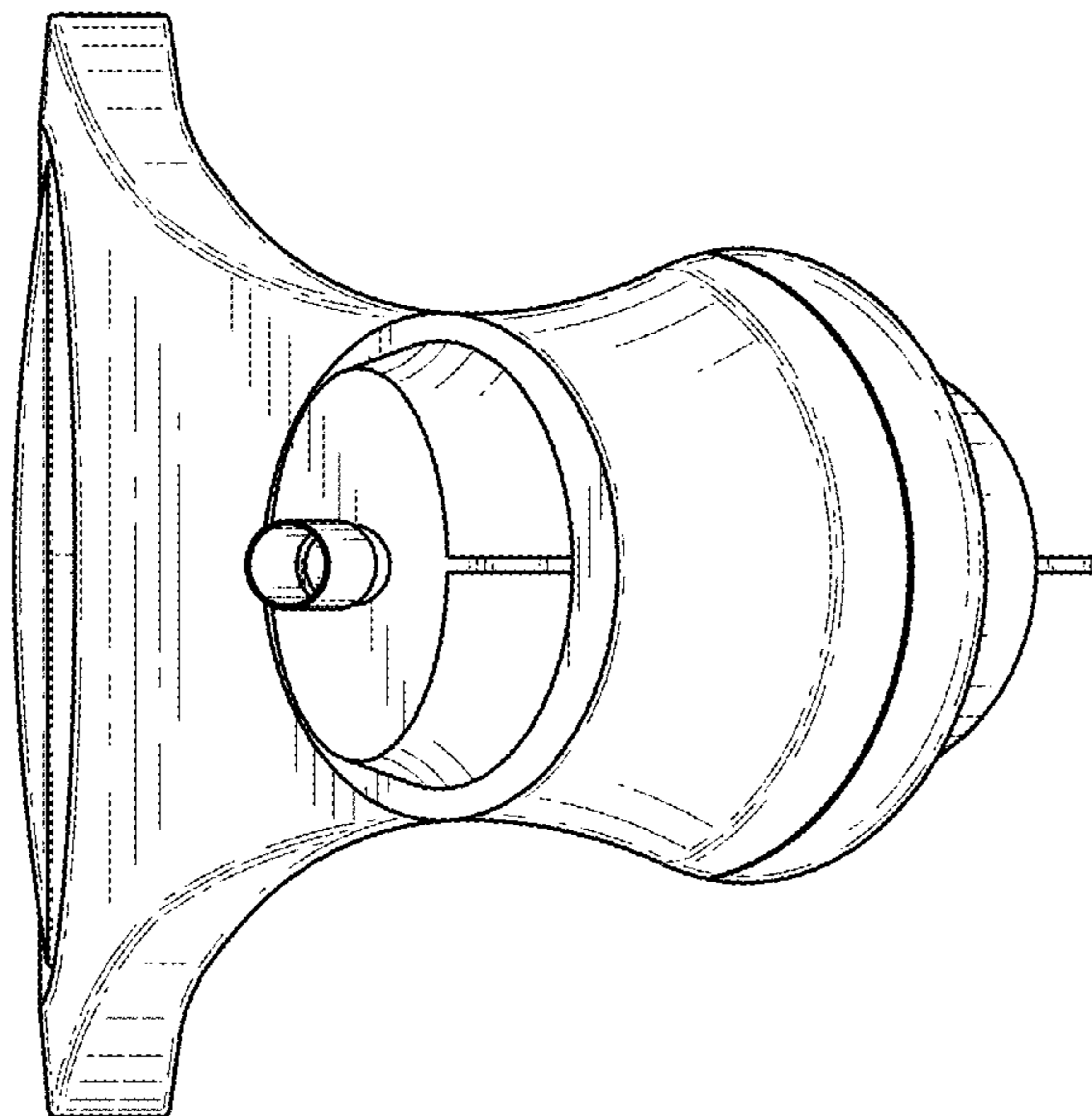

FIG. 13