



US00D902964S

(12) **United States Design Patent**
Lozano

(10) **Patent No.:** **US D902,964 S**

(45) **Date of Patent:** **** Nov. 24, 2020**

(54) **KEG COOLER**

(71) Applicant: **Francisco Lozano**, Texarkana, TX (US)

(72) Inventor: **Francisco Lozano**, Texarkana, TX (US)

(**) Term: **15 Years**

(21) Appl. No.: **29/641,969**

(22) Filed: **Mar. 26, 2018**

(51) **LOC (12) Cl.** **15-07**

(52) **U.S. Cl.**

USPC **D15/81**

(58) **Field of Classification Search**

USPC D15/79-91

CPC F25D 17/065; F25D 23/028; F25D 23/126;

F25D 11/02; F25D 2201/126; F25D

2201/1262; F25D 2201/14; F25D

2323/021; F25D 23/02; F25D 23/025;

F25D 23/04; F25D 23/062; F25D 23/064;

F25D 23/065; F25D 23/067; F25D

2400/361; F25D 25/025; F25D 25/04;

F25D 29/005; F25D 29/006; F25D

31/005; F25D 3/06

See application file for complete search history.

(56) **References Cited**

U.S. PATENT DOCUMENTS

D265,202 S * 6/1982 Thomsen D15/79

D277,041 S * 1/1985 Nichols D34/39

D287,133 S * 12/1986 Owen D15/81

4,679,407 A * 7/1987 Kim F25D 3/107

62/294

D313,026 S * 12/1990 Evans D15/81

D352,296 S * 11/1994 Westendorf D15/81

D576,833 S * 9/2008 Mansell D7/332

D762,743 S * 8/2016 Fan D15/81

D843,766 S * 3/2019 Murray D7/313

* cited by examiner

Primary Examiner — Khawaja Anwar

(74) *Attorney, Agent, or Firm* — Eric A. Hinojosa

(57) **CLAIM**

I claim the ornamental design for a keg cooler, as shown and described.

DESCRIPTION

FIG. 1 is a front perspective view.

FIG. 2 is a back perspective view.

FIG. 3 is a left perspective view.

FIG. 4 is a right perspective view.

FIG. 5 is a bottom perspective view; and,

FIG. 6 is a top perspective view.

1 Claim, 6 Drawing Sheets

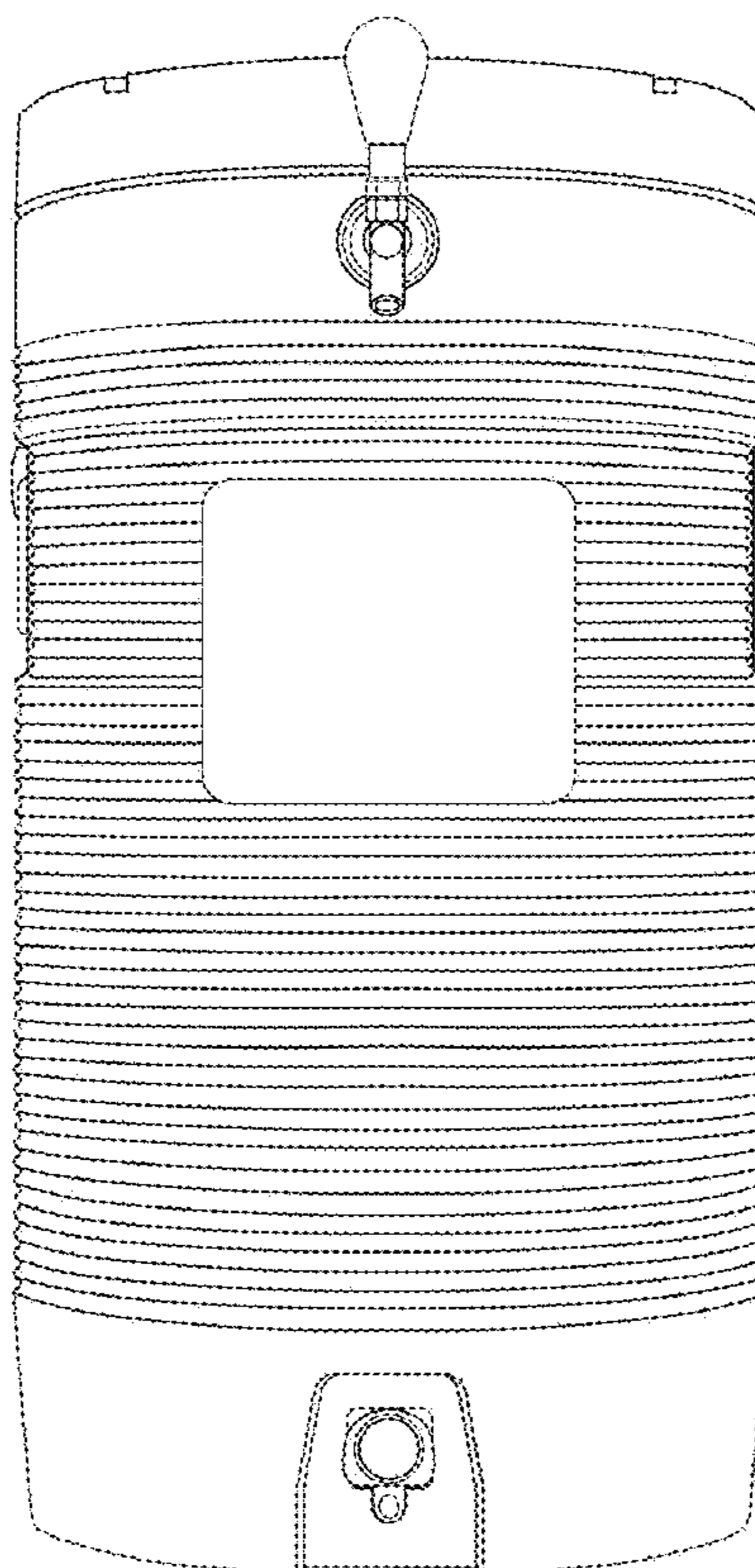

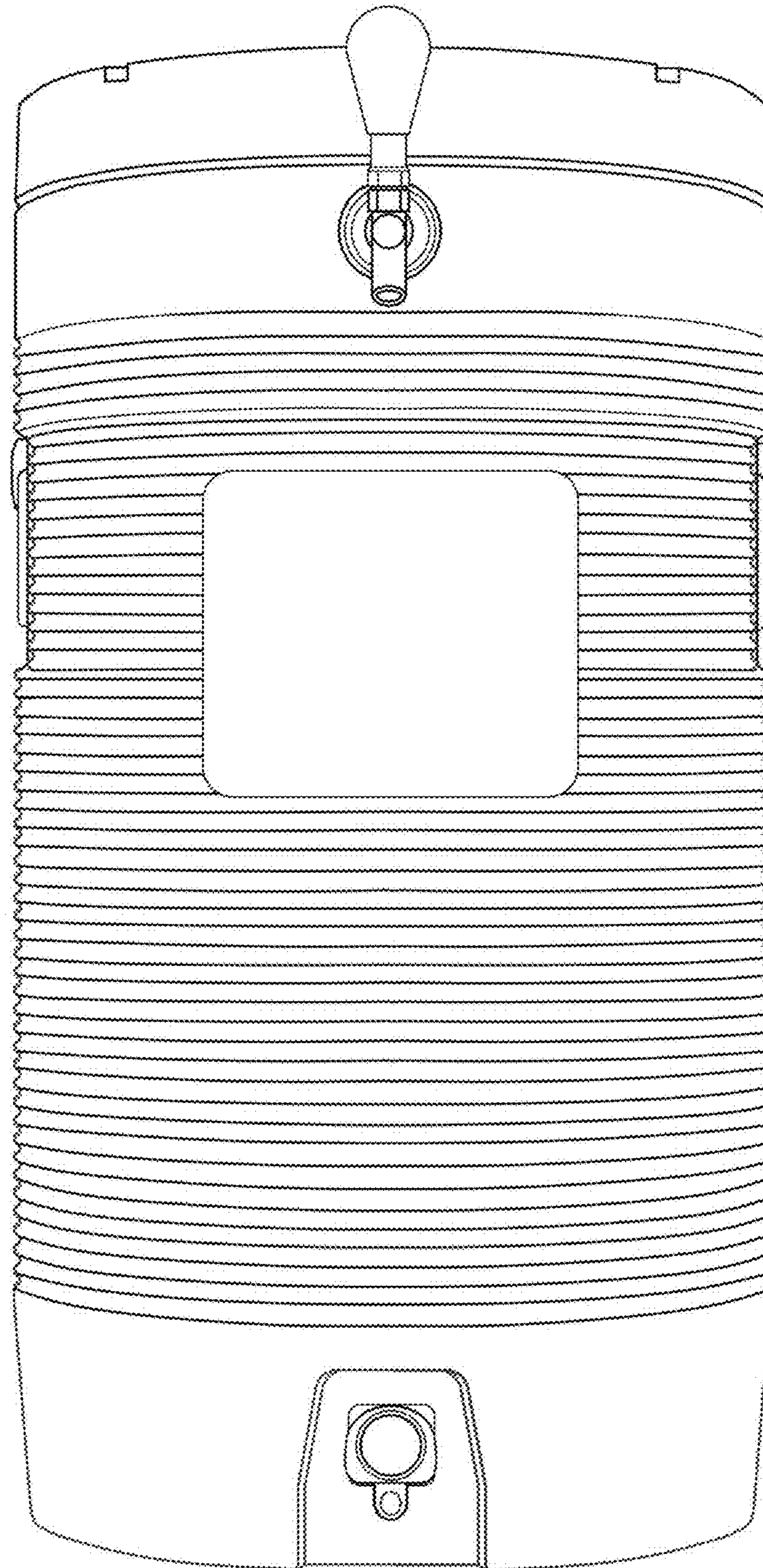

FIG. 1

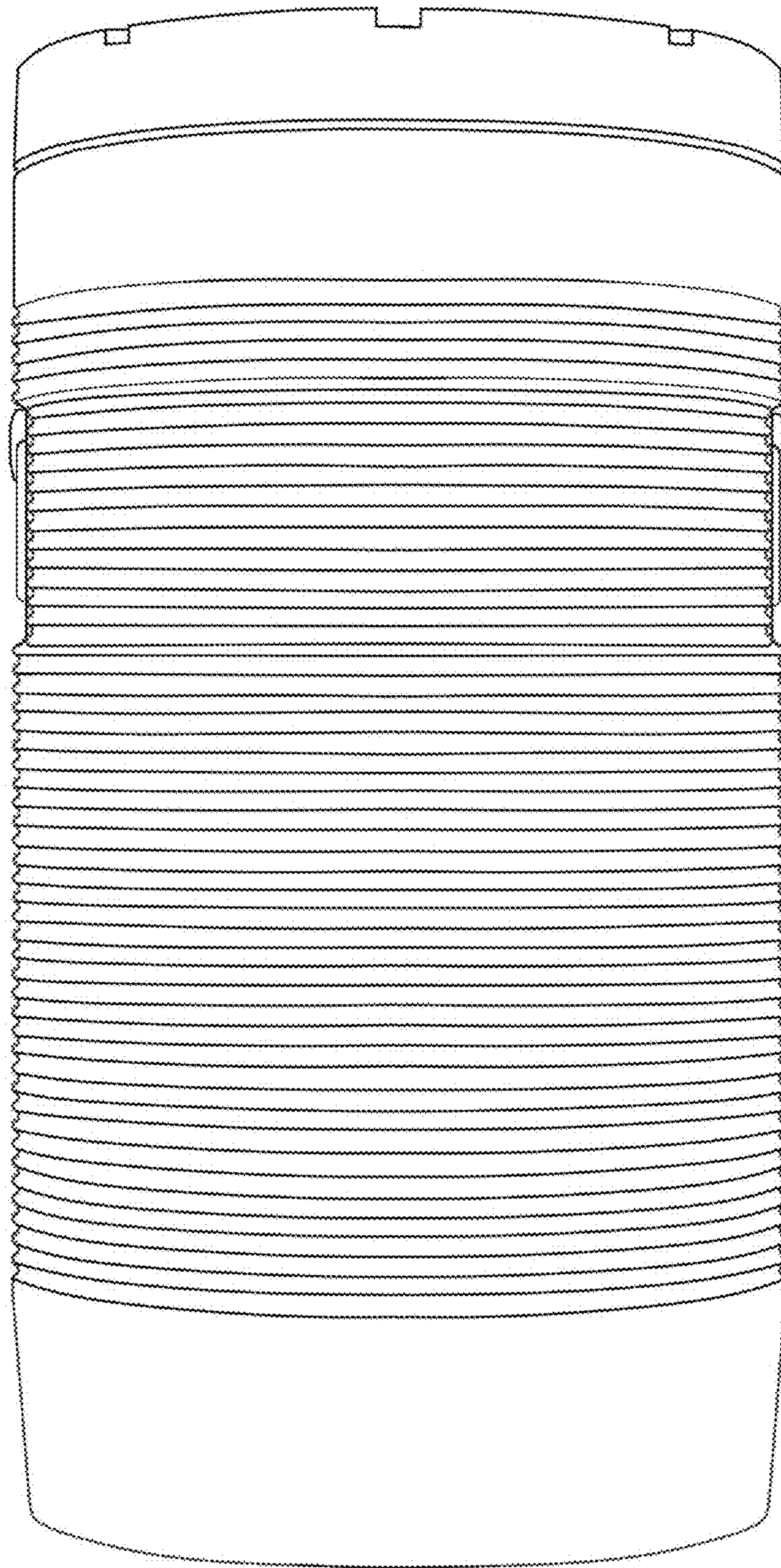

FIG. 2

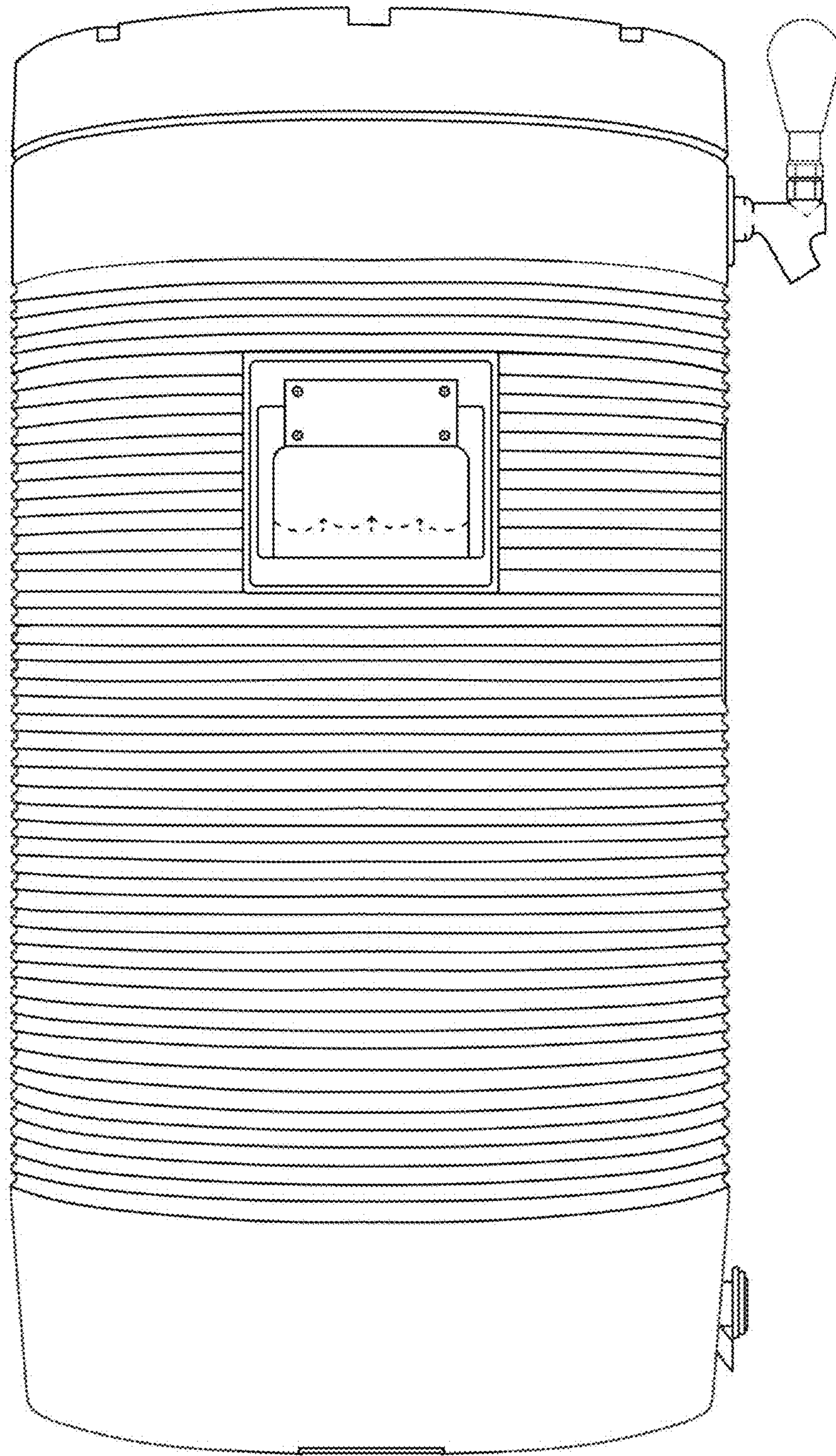

FIG. 3

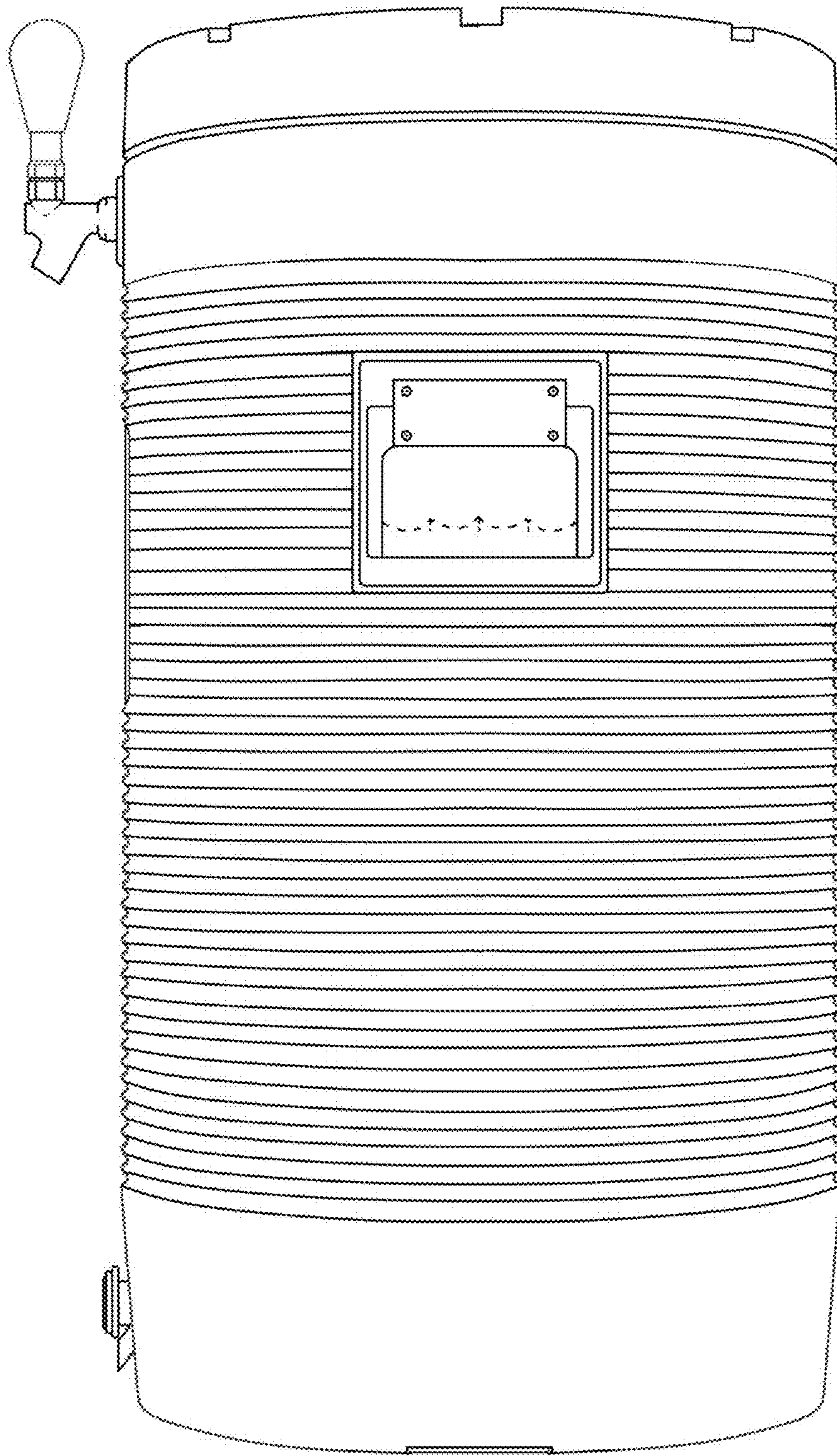

FIG. 4

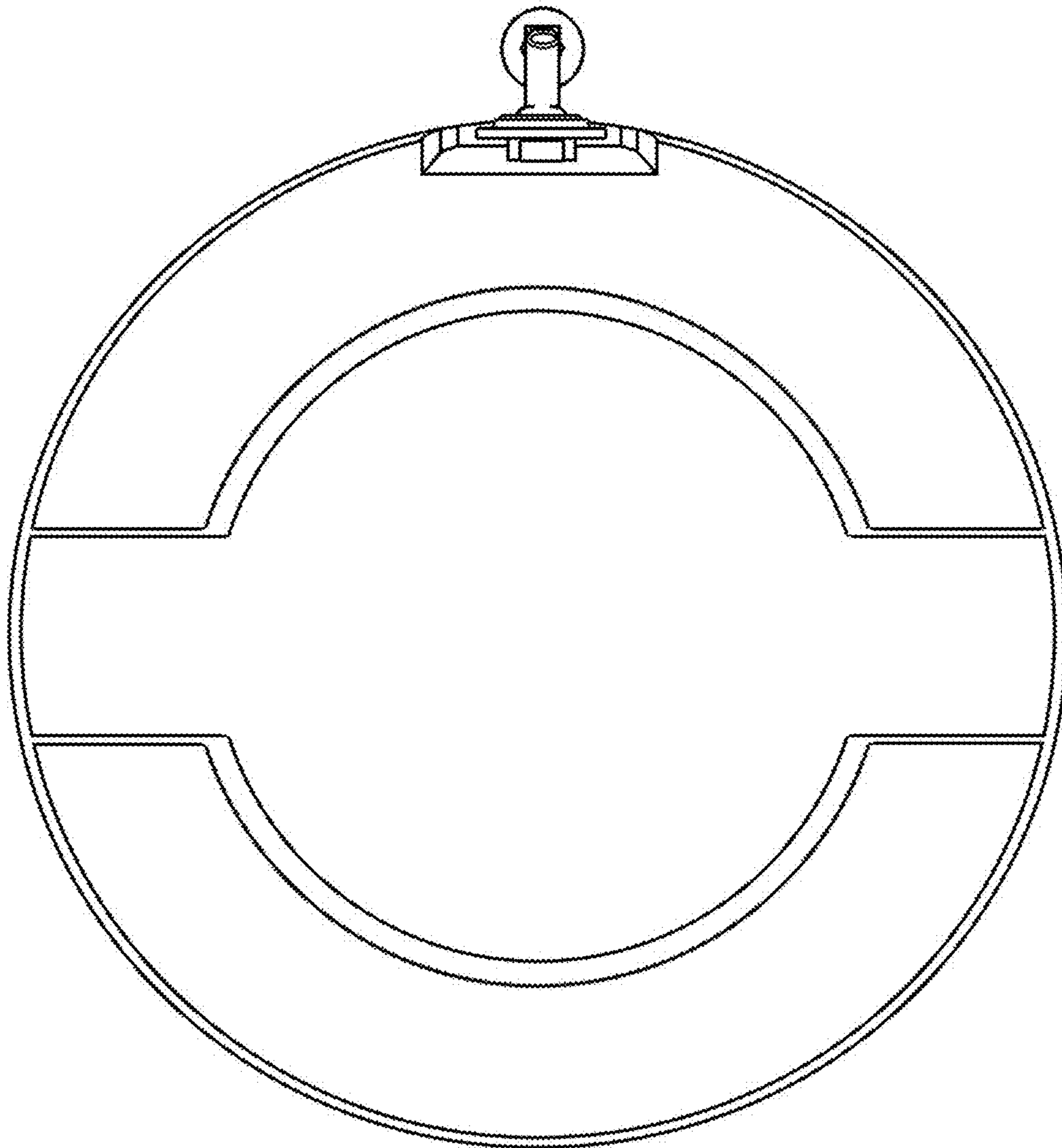

FIG. 5

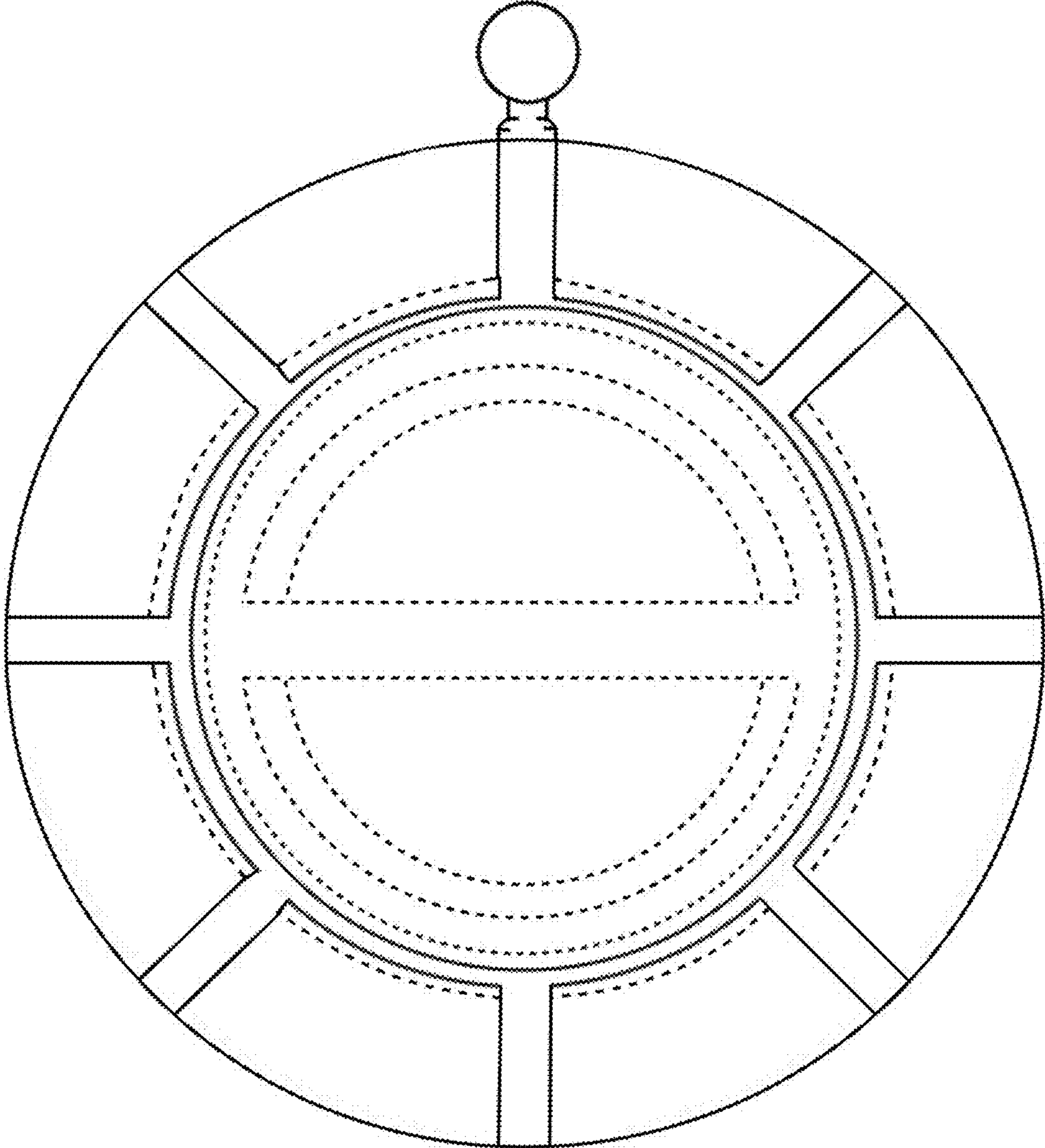

FIG. 6