



US00D902892S

(12) **United States Design Patent**  
**Liu**

(10) **Patent No.:** **US D902,892 S**  
(45) **Date of Patent:** **\*\* Nov. 24, 2020**

(54) **BLUETOOTH HEADPHONE**

(71) Applicant: **Chunhong Liu**, Nanchong (CN)

(72) Inventor: **Chunhong Liu**, Nanchong (CN)

(\*\*) Term: **15 Years**

(21) Appl. No.: **29/691,398**

(22) Filed: **May 16, 2019**

(30) **Foreign Application Priority Data**

Mar. 1, 2019 (CN) ..... 2019 3 0083770

(51) **LOC (12) Cl.** ..... **14-01**

(52) **U.S. Cl.**  
USPC ..... **D14/223**

(58) **Field of Classification Search**  
USPC ..... D14/223, 205, 206; D24/174; 128/864,  
128/865, 866; 181/129, 130, 135;

(Continued)

(56) **References Cited**

**U.S. PATENT DOCUMENTS**

D557,254 S \* 12/2007 Engstrom ..... D14/205

D563,945 S \* 3/2008 Johns ..... D14/205

(Continued)

*Primary Examiner* — Katie Jane Stofko

(57) **CLAIM**

The ornamental design for a Bluetooth headphone, as shown and described.

**DESCRIPTION**

FIG. 1 is a perspective view of a first embodiment of a Bluetooth headphone showing my new design;

FIG. 2 is another perspective view thereof;

FIG. 3 is a front elevational view thereof;

FIG. 4 is a rear elevational view thereof;

FIG. 5 is a left side elevational view thereof;

FIG. 6 is a right side elevational view thereof;

FIG. 7 is a top plan view thereof;

FIG. 8 is a bottom plan view thereof;

FIG. 9 is a perspective view of a second embodiment of the Bluetooth headphone showing my new design;

FIG. 10 is a front elevational view thereof;

FIG. 11 is a rear elevational view thereof;

FIG. 12 is a left side elevational view thereof;

FIG. 13 is a right side elevational view thereof;

FIG. 14 is a top plan view thereof;

FIG. 15 is a bottom plan view thereof;

FIG. 16 is a perspective view of a third embodiment of the Bluetooth headphone showing my new design;

FIG. 17 is a front elevational view thereof;

FIG. 18 is a rear elevational view thereof;

FIG. 19 is a left side elevational view thereof;

FIG. 20 is a right side elevational view thereof;

FIG. 21 is a top plan view thereof;

FIG. 22 is a bottom plan view thereof;

FIG. 23 is a perspective view of a fourth embodiment of the Bluetooth headphone showing my new design;

FIG. 24 is a front elevational view thereof;

FIG. 25 is a rear elevational view thereof;

FIG. 26 is a left side elevational view thereof;

FIG. 27 is a right side elevational view thereof;

FIG. 28 is a top plan view thereof;

FIG. 29 is a bottom plan view thereof;

FIG. 30 is a perspective view of a fifth embodiment of the Bluetooth headphone showing my new design;

FIG. 31 is a front elevational view thereof;

FIG. 32 is a rear elevational view thereof;

FIG. 33 is a left side elevational view thereof;

FIG. 34 is a right side elevational view thereof;

FIG. 35 is a top plan view thereof;

FIG. 36 is a bottom plan view thereof;

FIG. 37 is a perspective view of a sixth embodiment of the Bluetooth headphone showing my new design;

FIG. 38 is a front elevational view thereof;

FIG. 39 is a rear elevational view thereof;

FIG. 40 is a left side elevational view thereof;

FIG. 41 is a right side elevational view thereof;

FIG. 42 is a top plan view thereof;

FIG. 43 is a bottom plan view thereof;

(Continued)

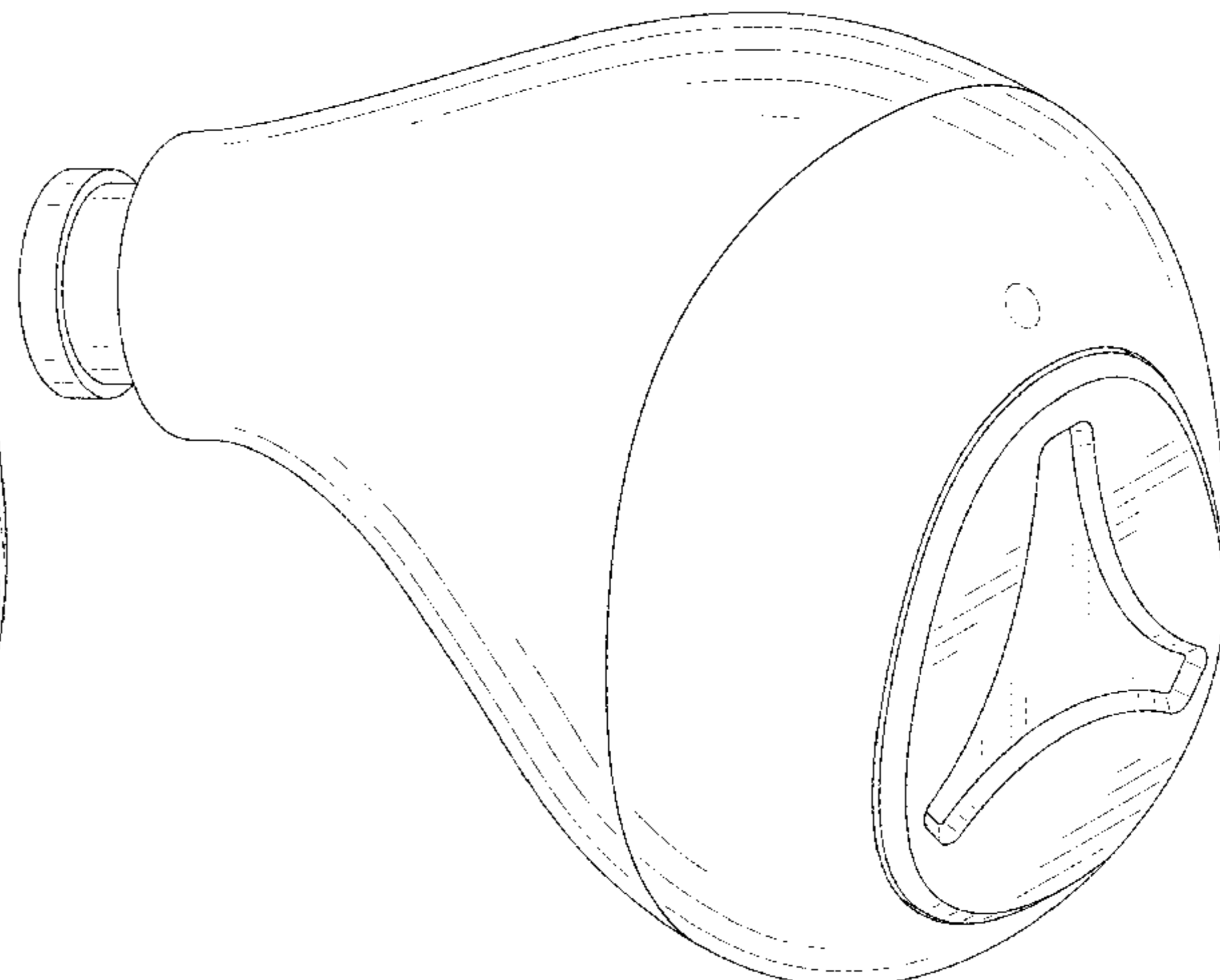
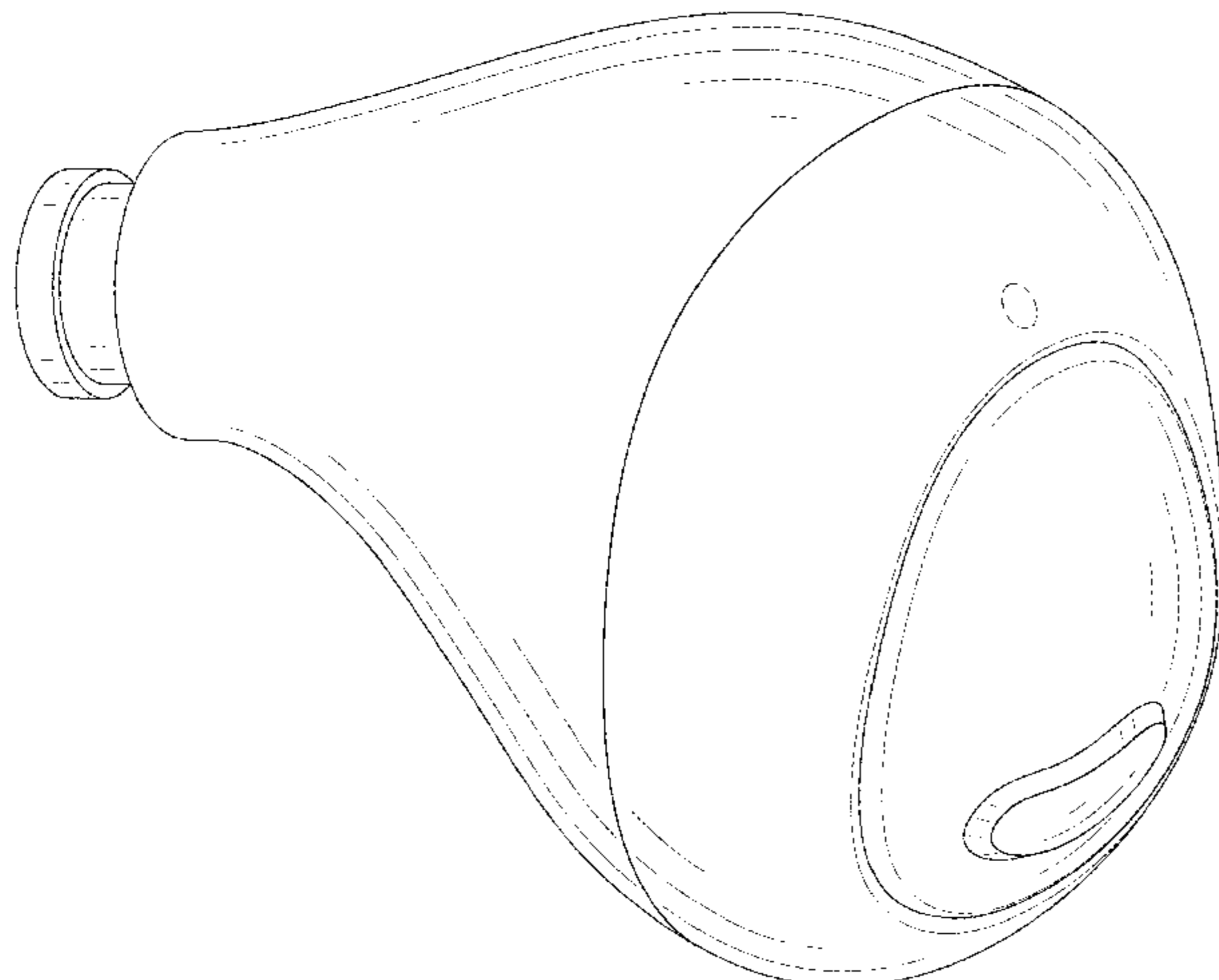

FIG. 41 is a perspective view of a seventh embodiment of the Bluetooth headphone showing my new design;  
 FIG. 45 is a front elevational view thereof;  
 FIG. 46 is a rear elevational view thereof;  
 FIG. 47 is a left side elevational view thereof;  
 FIG. 48 is a right side elevational view thereof;  
 FIG. 49 is a top plan view thereof;  
 FIG. 50 is a bottom plan view thereof;  
 FIG. 51 is a perspective view of a eighth embodiment of the Bluetooth headphone showing my new design;  
 FIG. 52 is a front elevational view thereof;  
 FIG. 53 is a rear elevational view thereof;  
 FIG. 54 is a left side elevational view thereof;  
 FIG. 55 is a right side elevational view thereof;  
 FIG. 56 is a top plan view thereof; and,  
 FIG. 57 is a bottom plan view thereof.  
 The broken lines in the drawings depict portions of the Bluetooth headphone that form no part of the claimed design.

**1 Claim, 57 Drawing Sheets**

(58) **Field of Classification Search**  
 USPC ..... 379/430, 431; 381/380, 381, 322-324, 381/330; 455/90.3, 575, 1, 569.1  
 CPC ..... H04R 1/10; H04R 25/00; H04R 1/1016; H04R 1/1066; H04R 5/033; H04R 5/0335; H04R 1/1091; H04R 1/1058; H04R 1/105; H04R 1/1083  
 See application file for complete search history.

(56) **References Cited**

U.S. PATENT DOCUMENTS

D601,134	S	*	9/2009	Elabidi	.....	D14/223
D618,219	S	*	6/2010	Burgett	.....	D14/223
D735,169	S	*	7/2015	Shieh	.....	D14/223
D801,951	S	*	11/2017	Bao	.....	D14/223
D805,060	S	*	12/2017	Loermann	.....	D14/223
D823,835	S	*	7/2018	Loermann	.....	D14/223
D834,561	S	*	11/2018	Bristol	.....	D14/223
D840,979	S	*	2/2019	Morris	.....	D14/223
D843,353	S	*	3/2019	Zhang	.....	D14/223
D864,167	S	*	10/2019	Wu	.....	D14/223
D868,750	S	*	12/2019	Zheng	.....	D14/223

\* cited by examiner

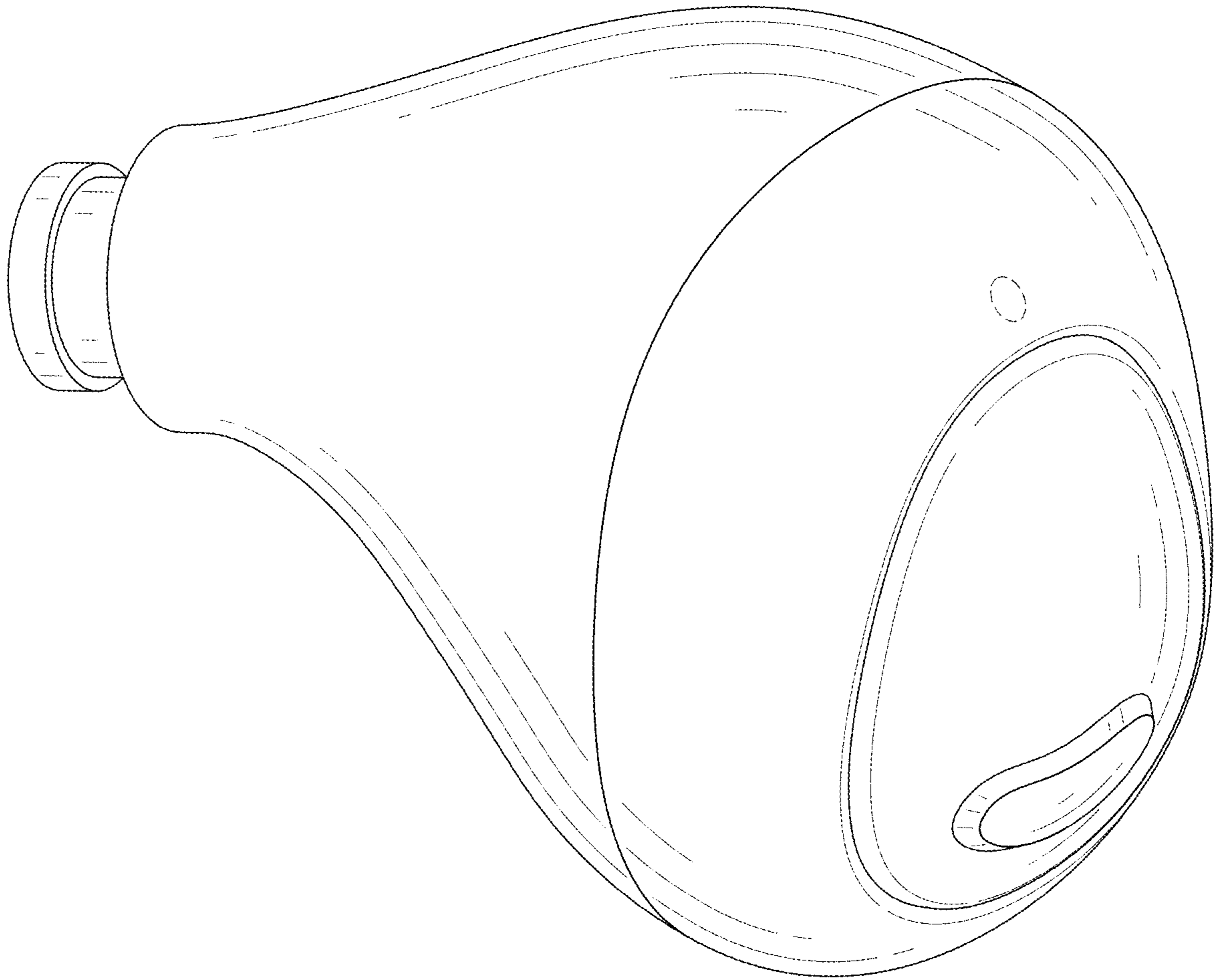

FIG. 1

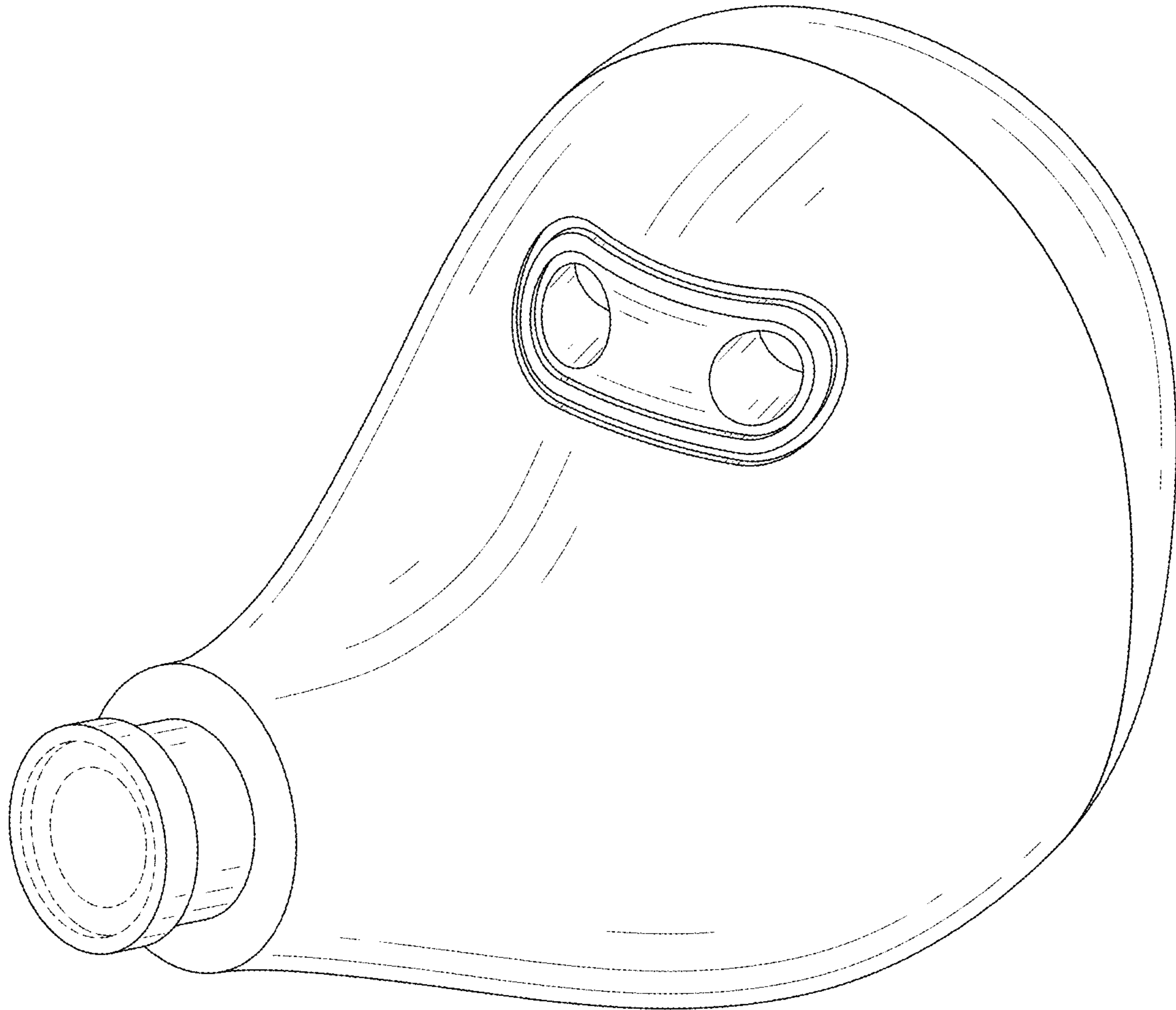

FIG. 2

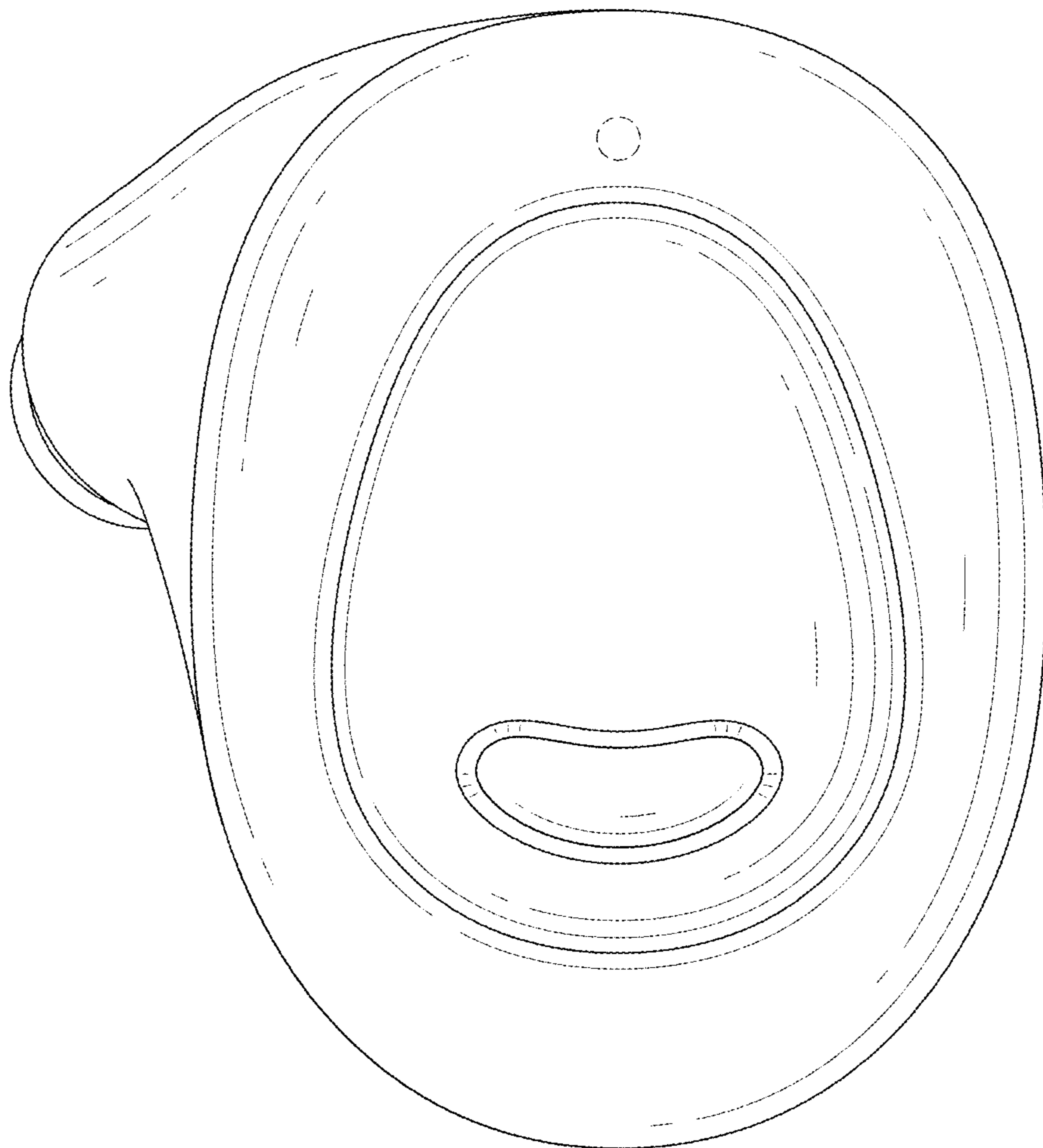

FIG. 3

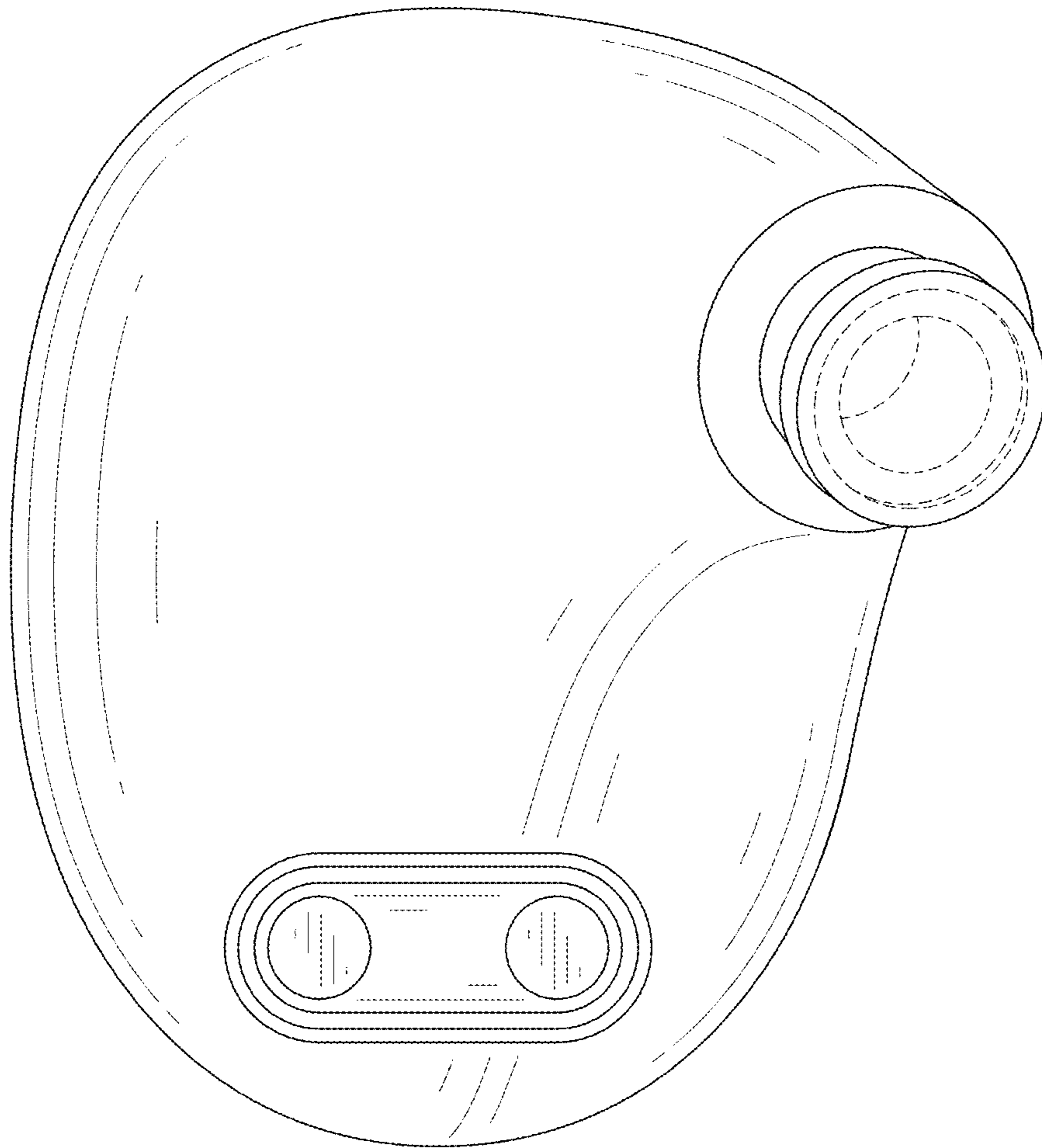

FIG. 4

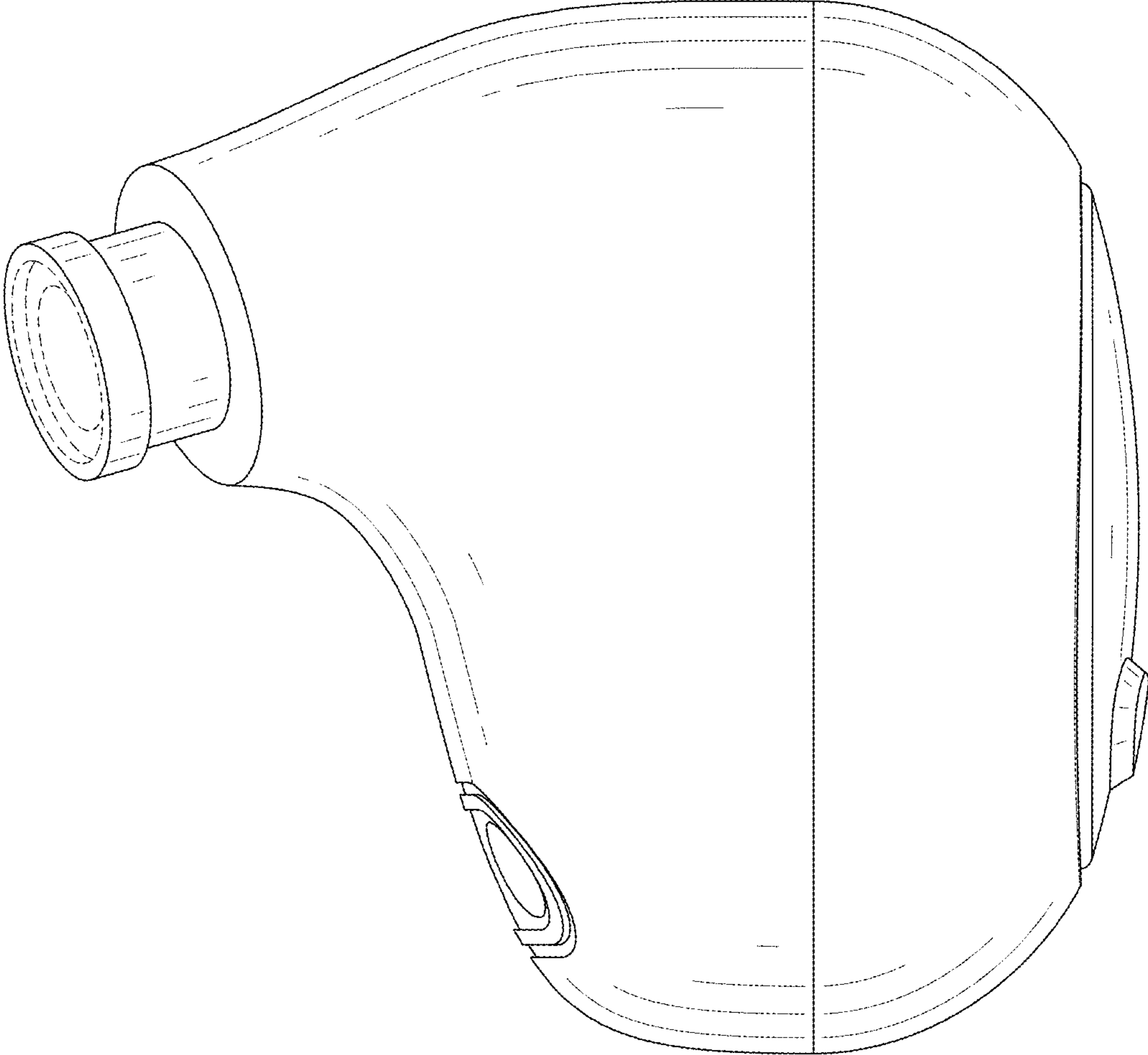

FIG. 5

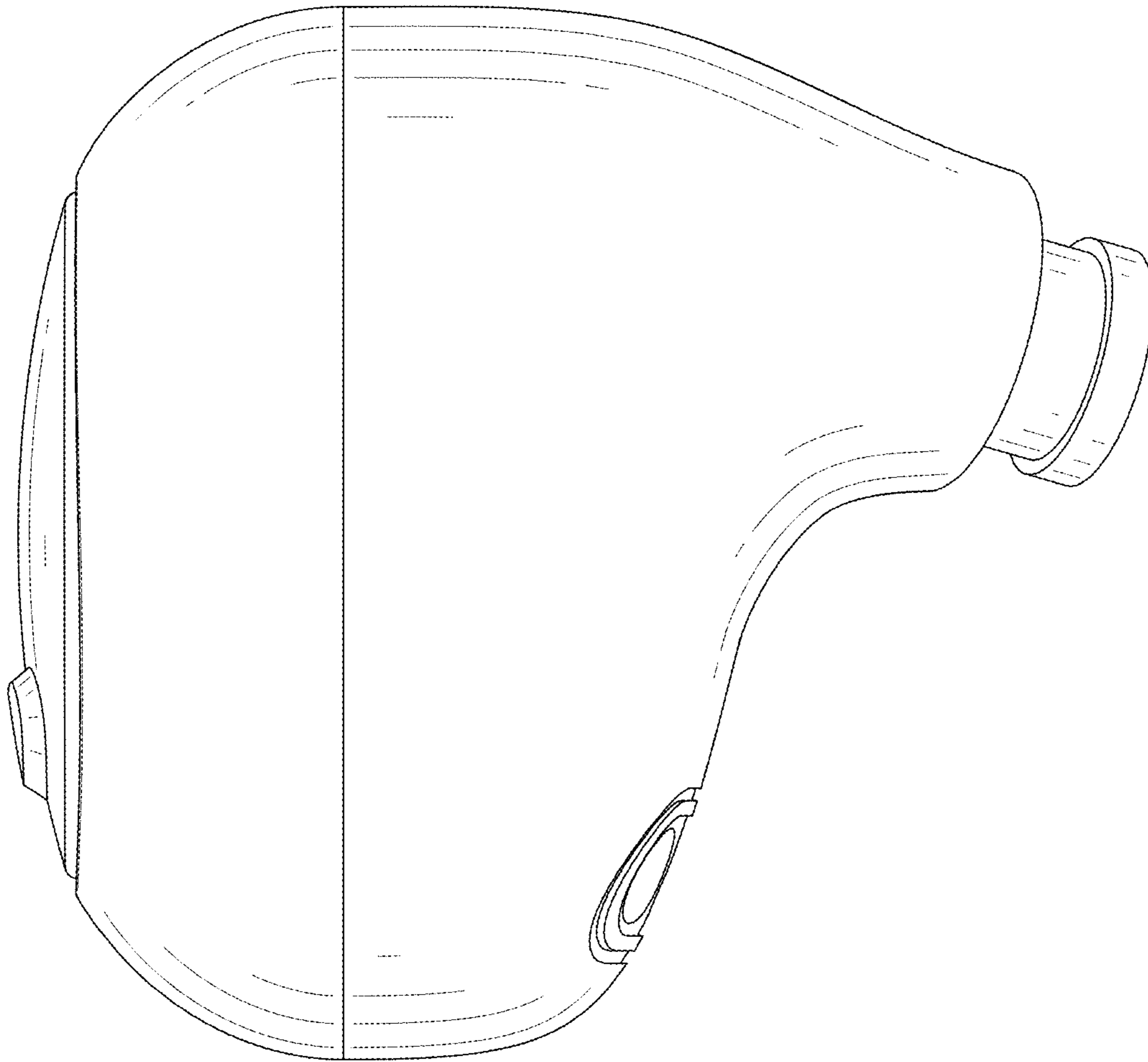

FIG. 6



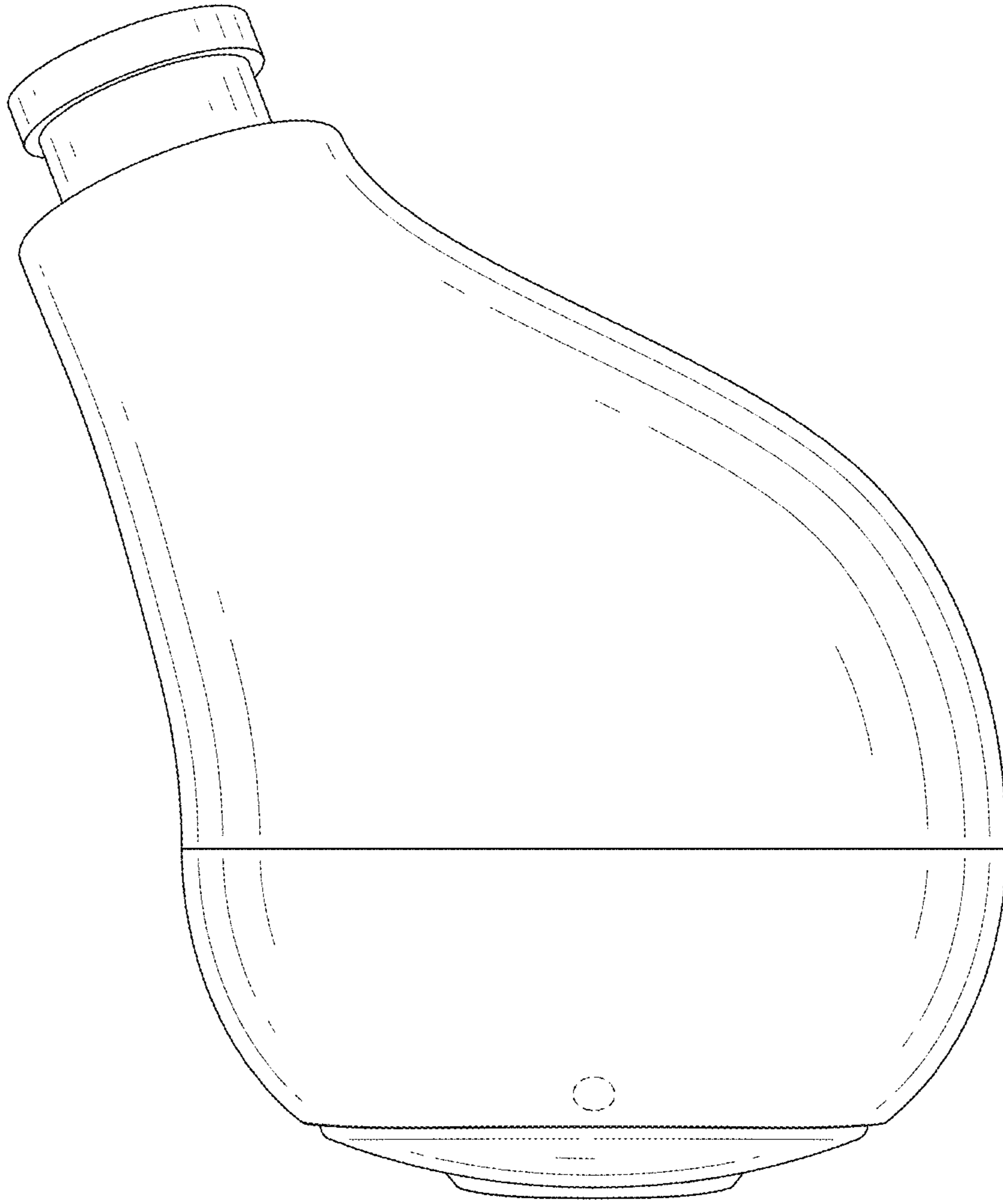

FIG. 7

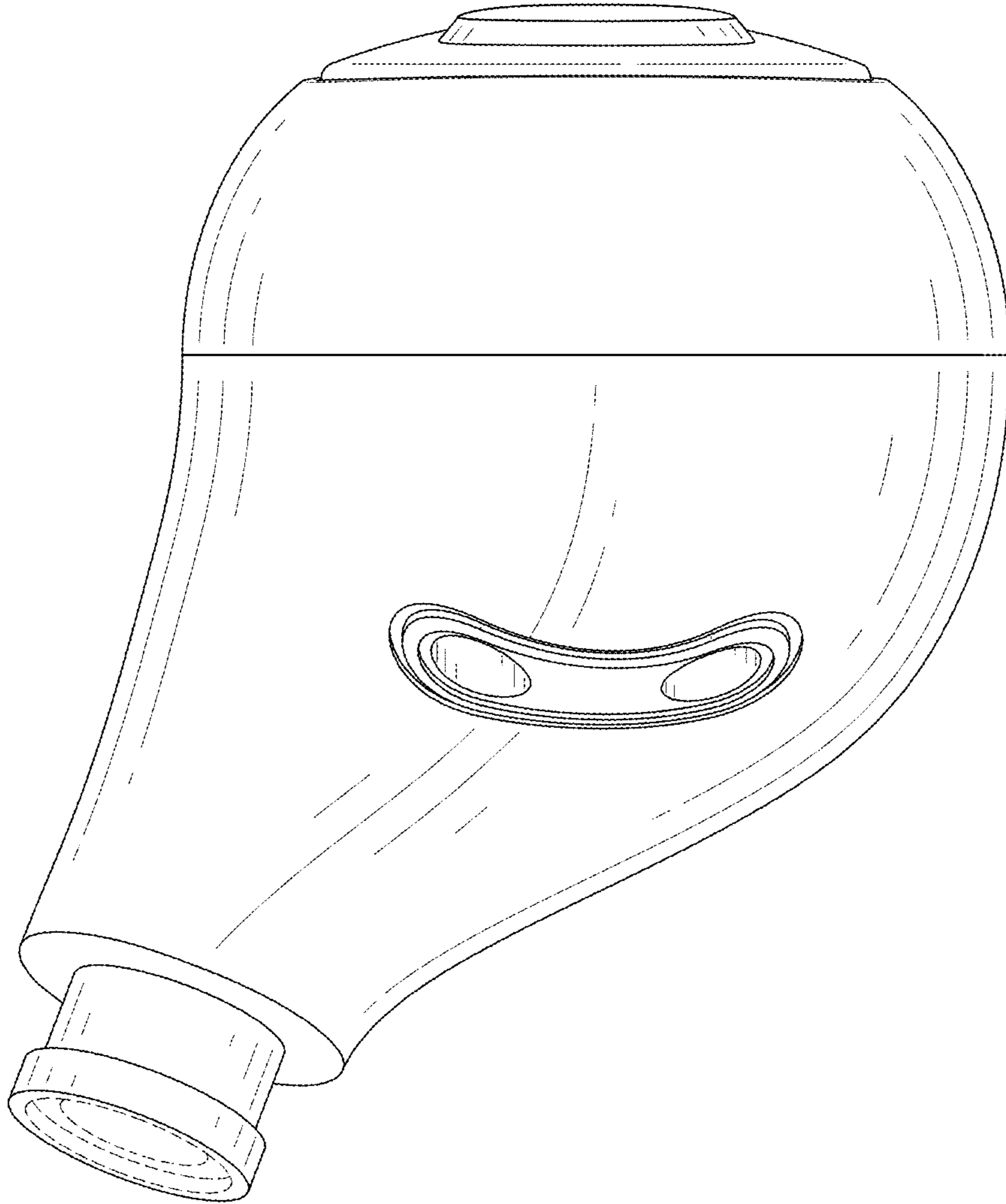

FIG. 8

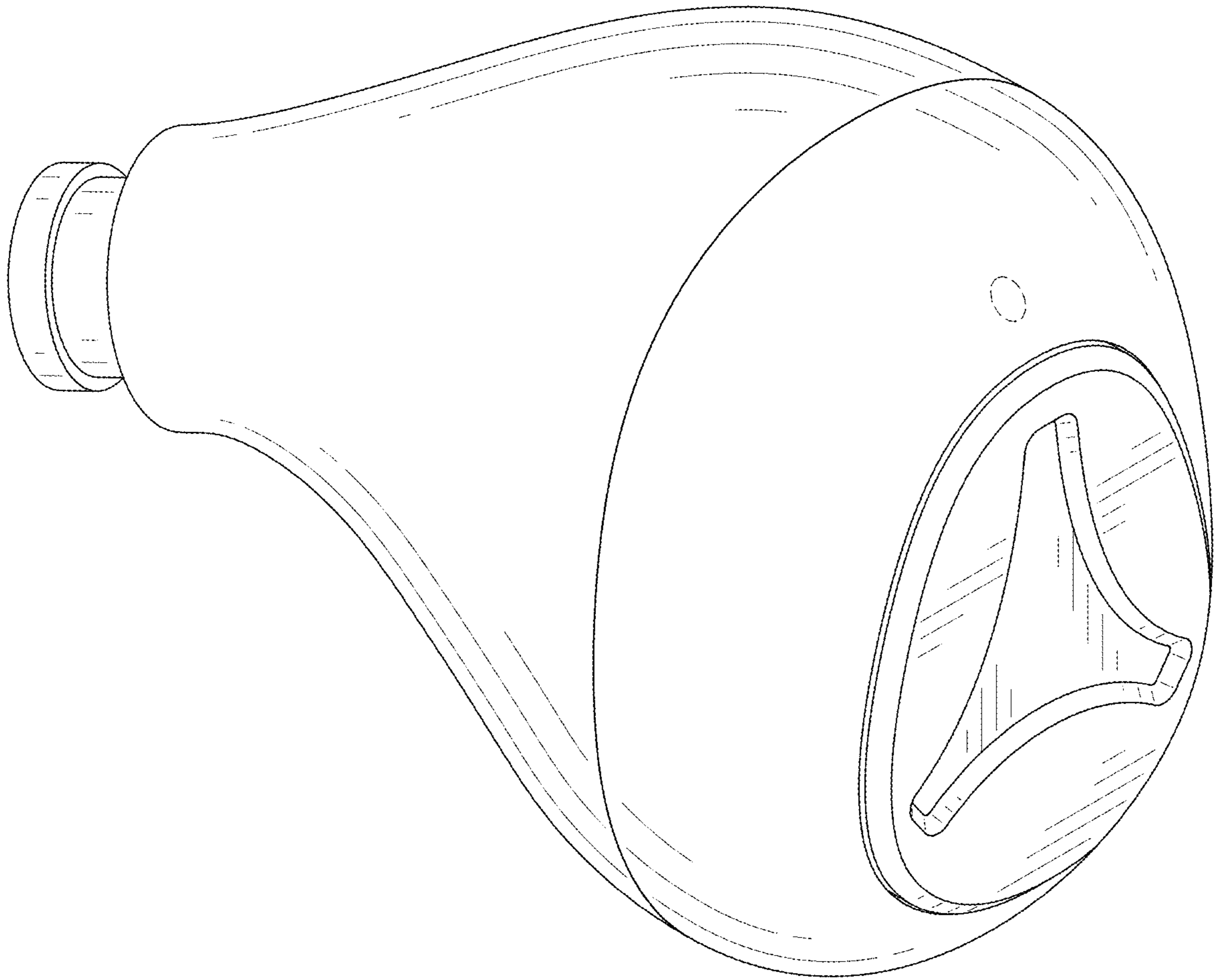

FIG. 9

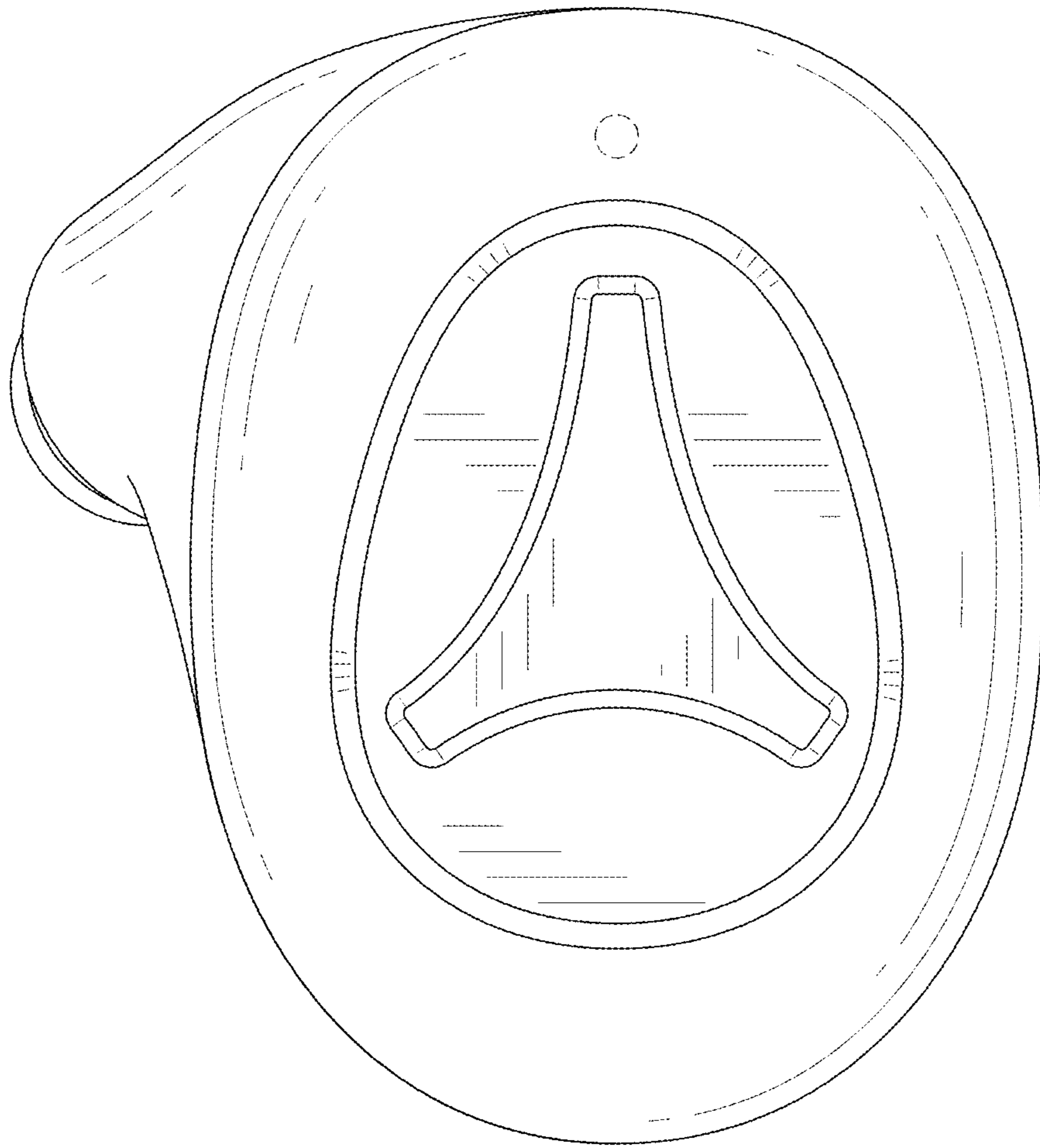

FIG. 10

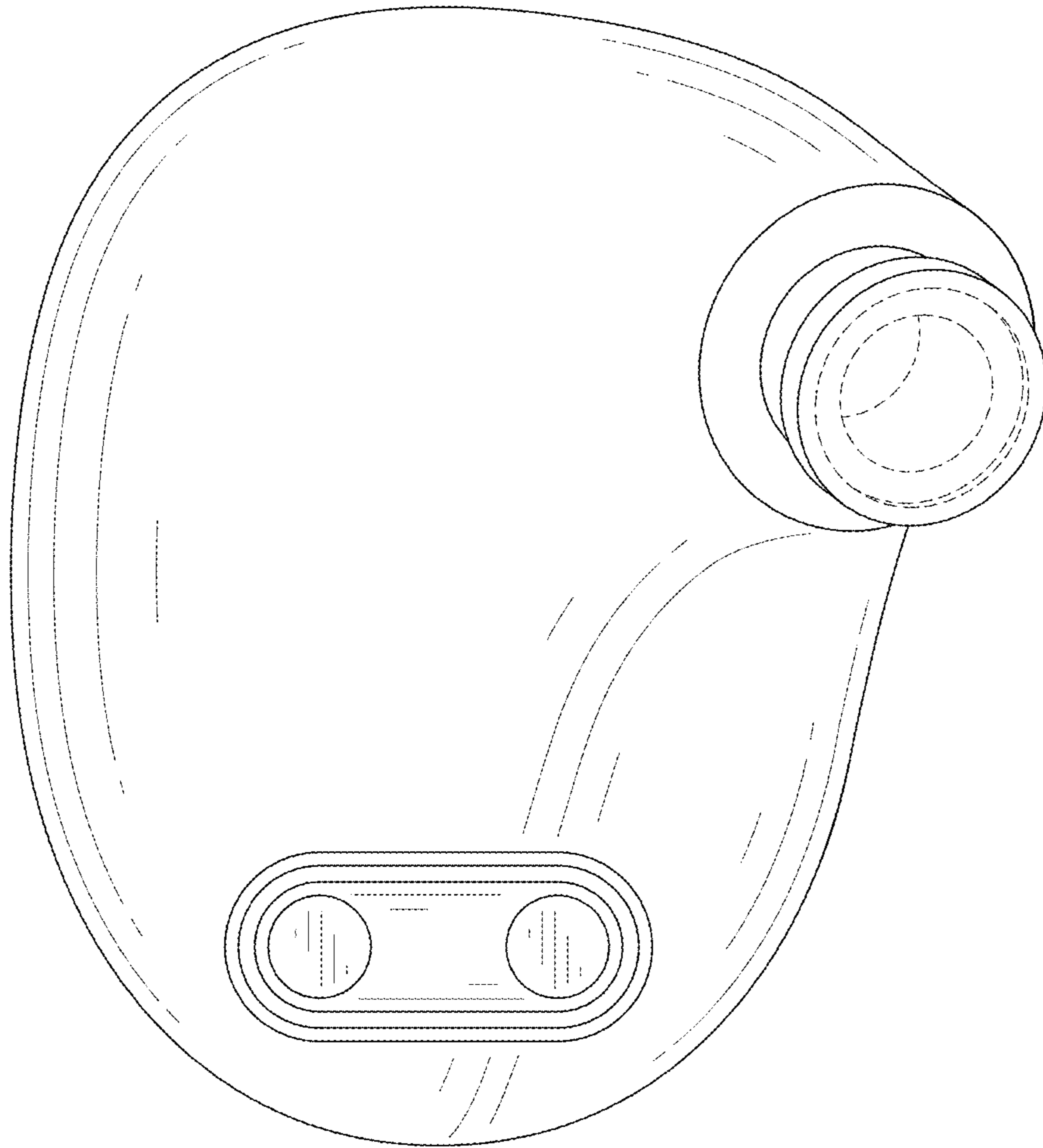

FIG. 11

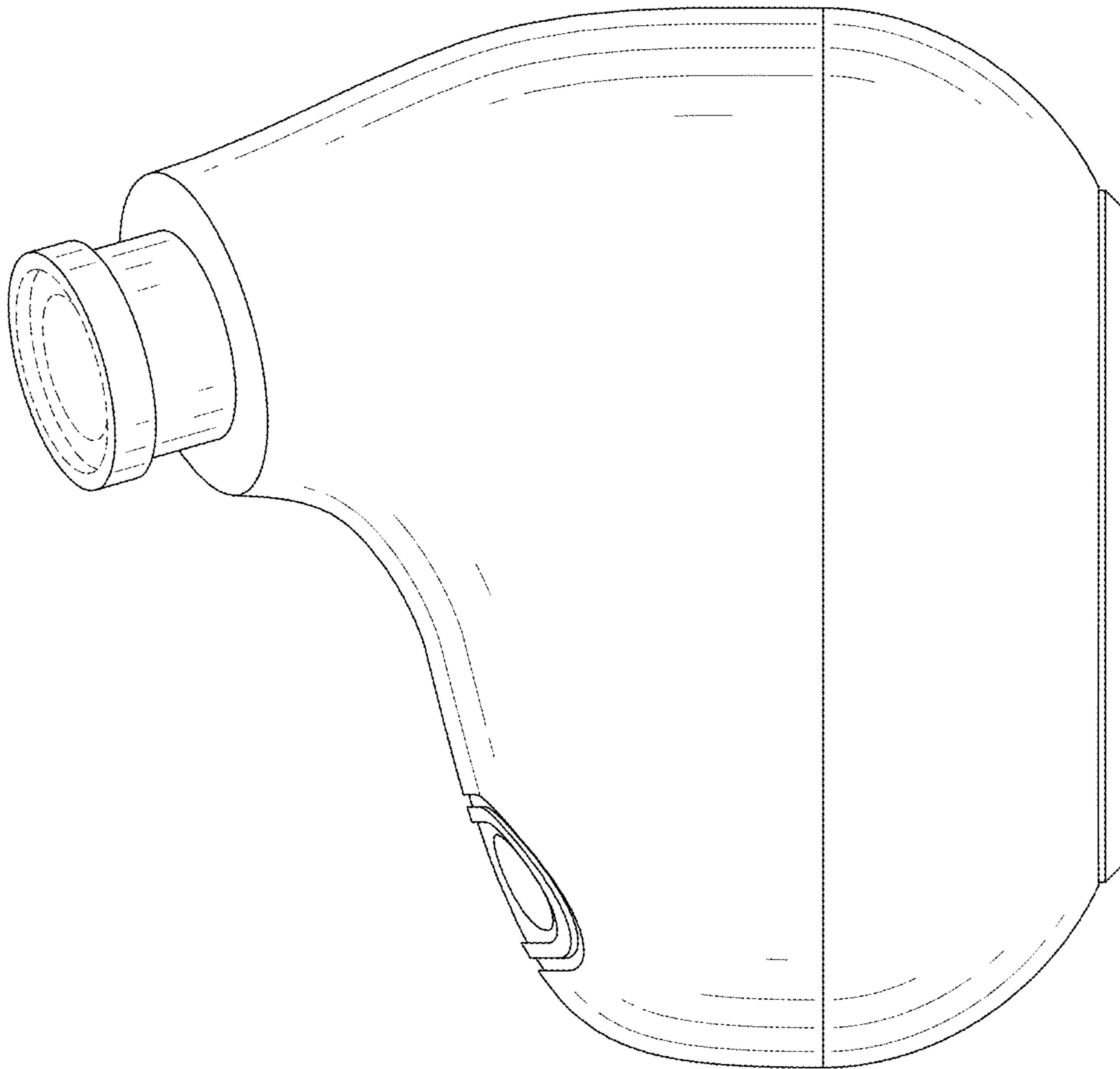

FIG. 12

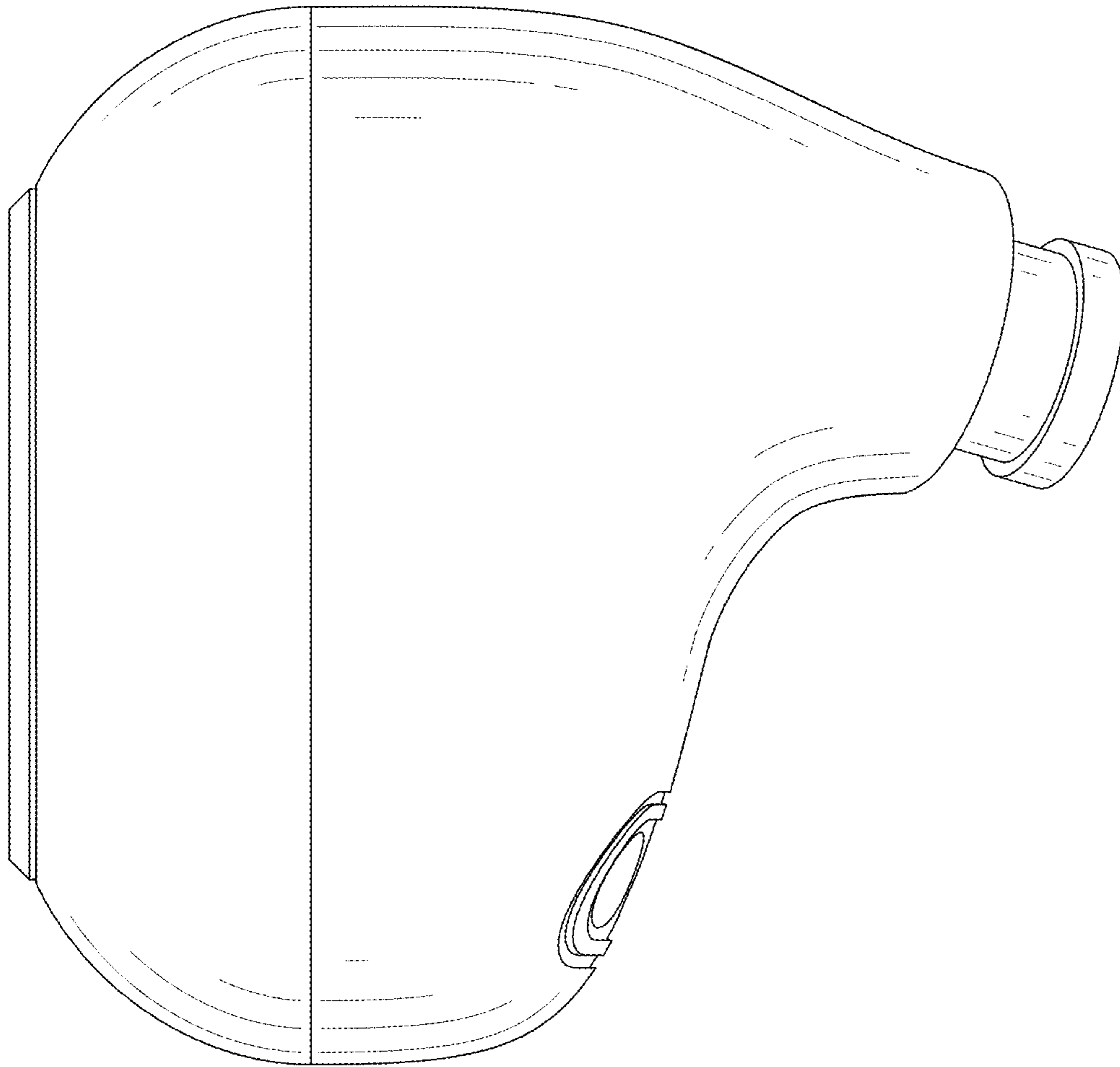

FIG. 13

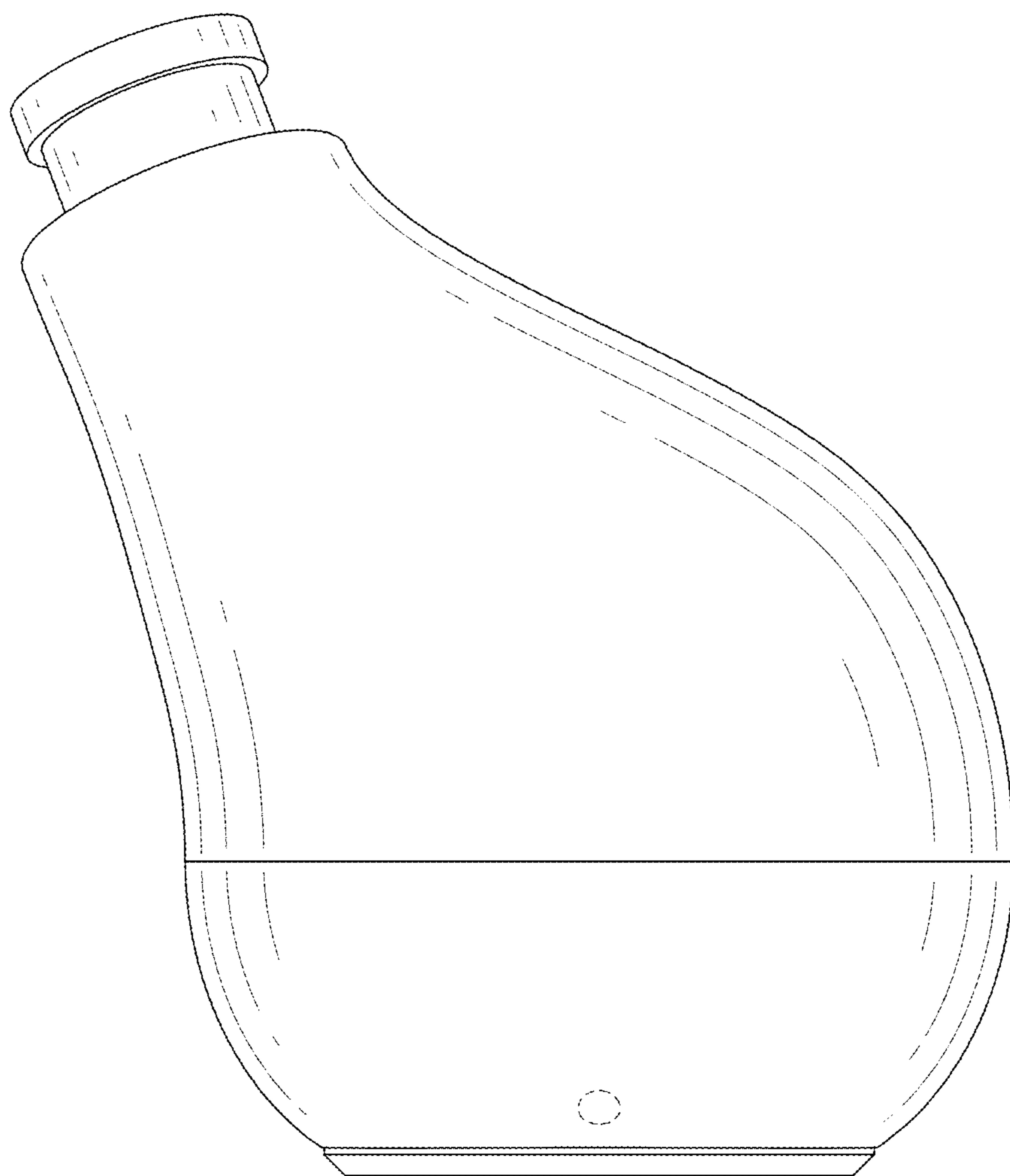

FIG. 14



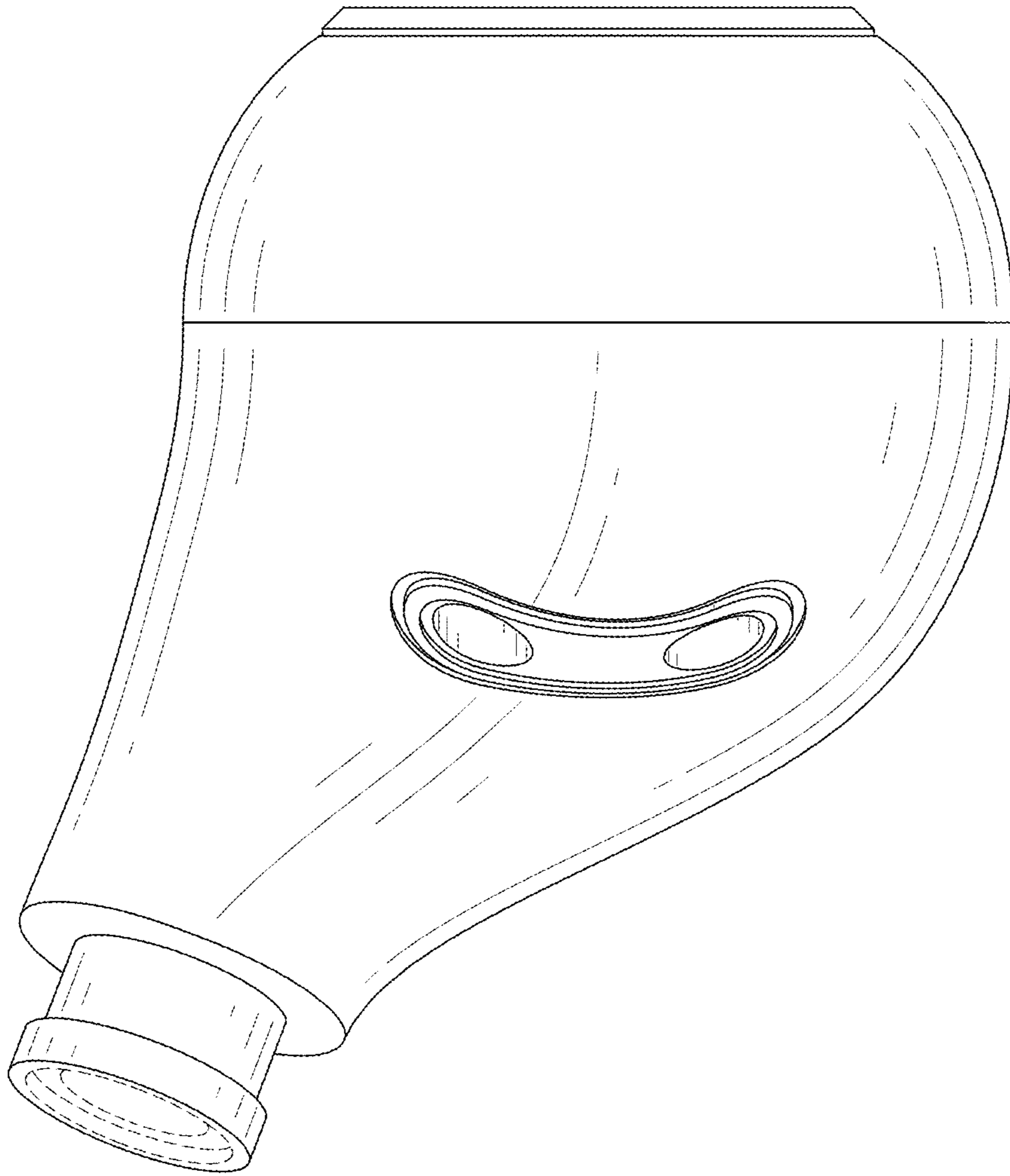

FIG. 15

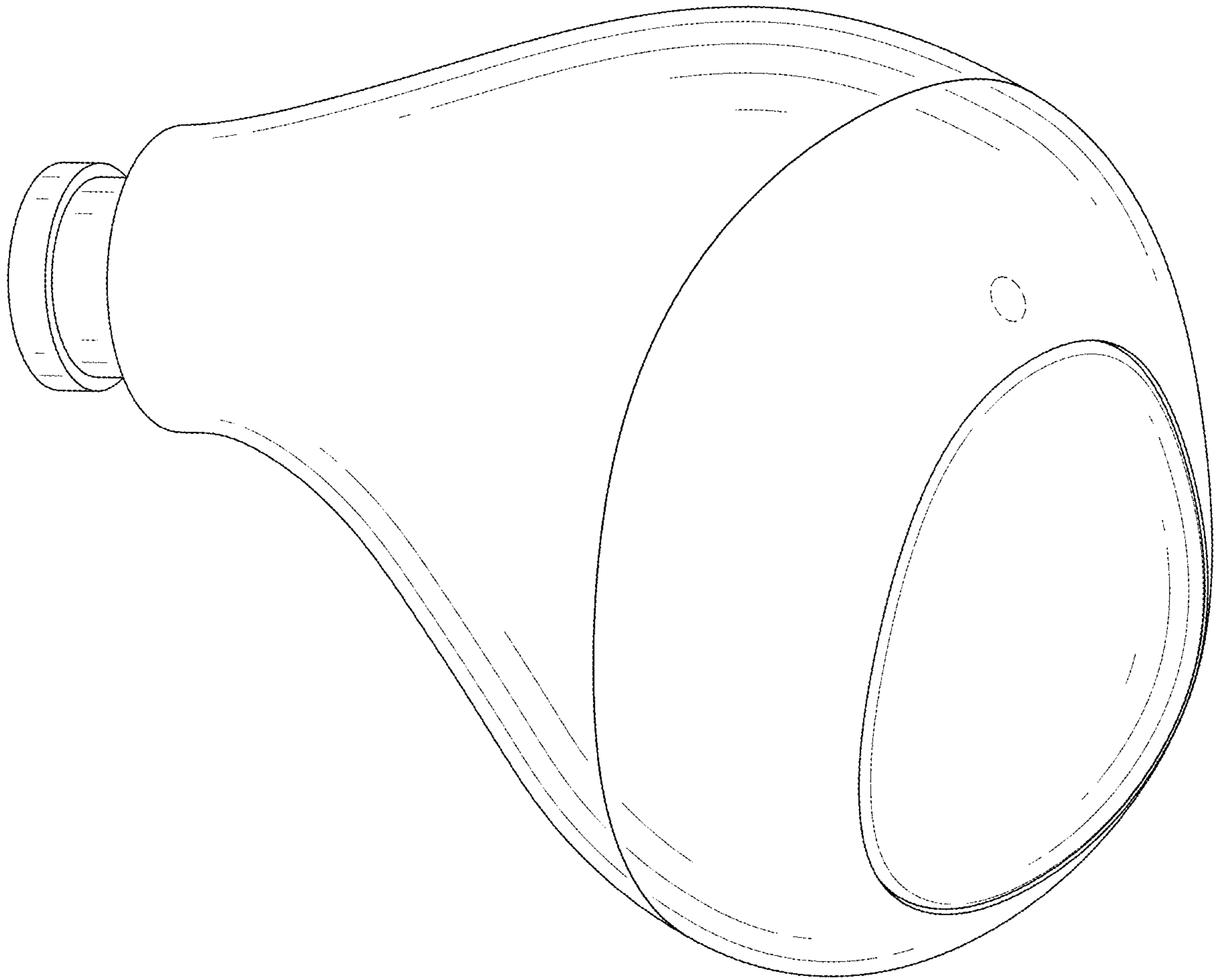

FIG. 16

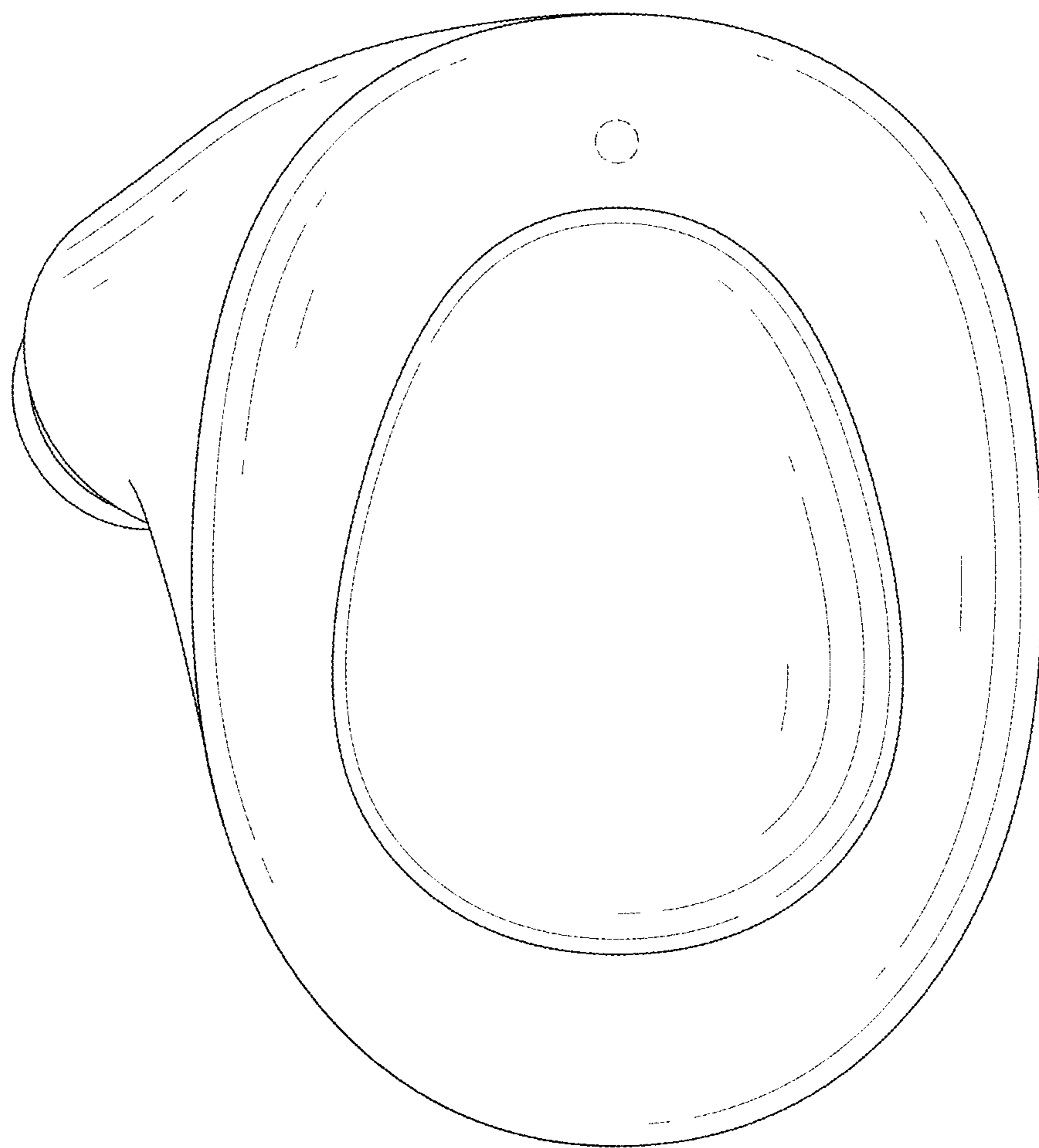

FIG. 17

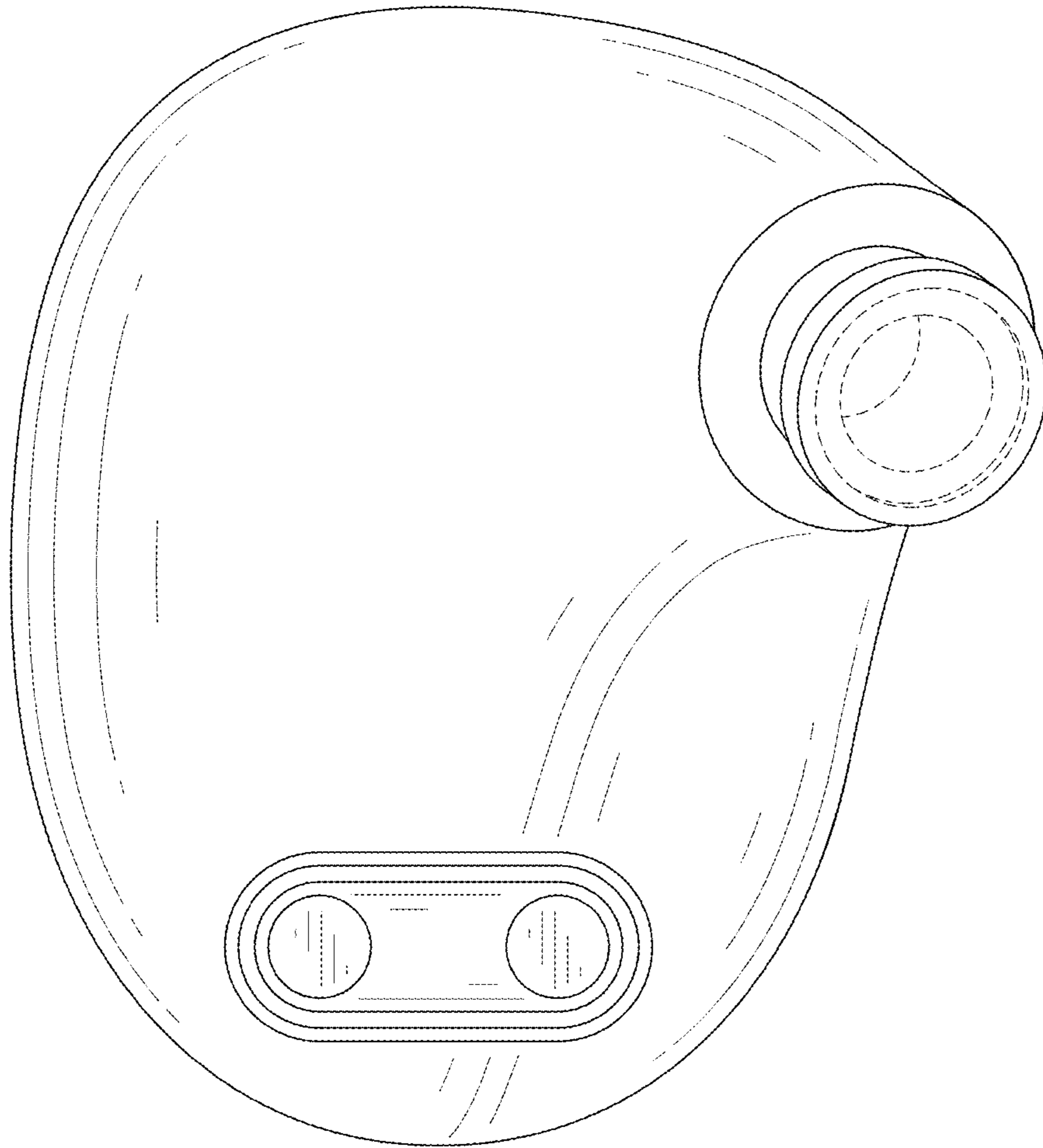

FIG. 18

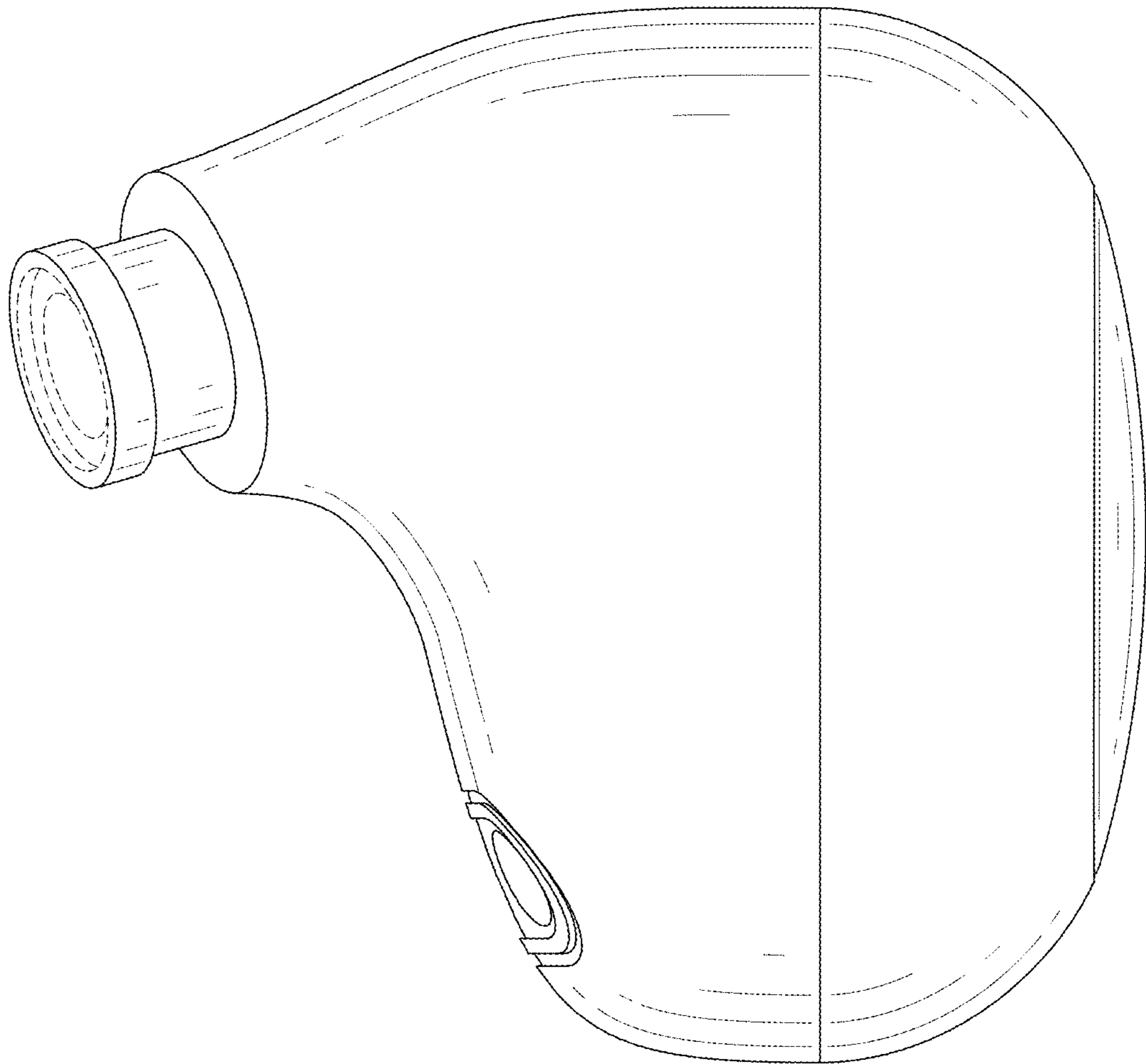

FIG. 19

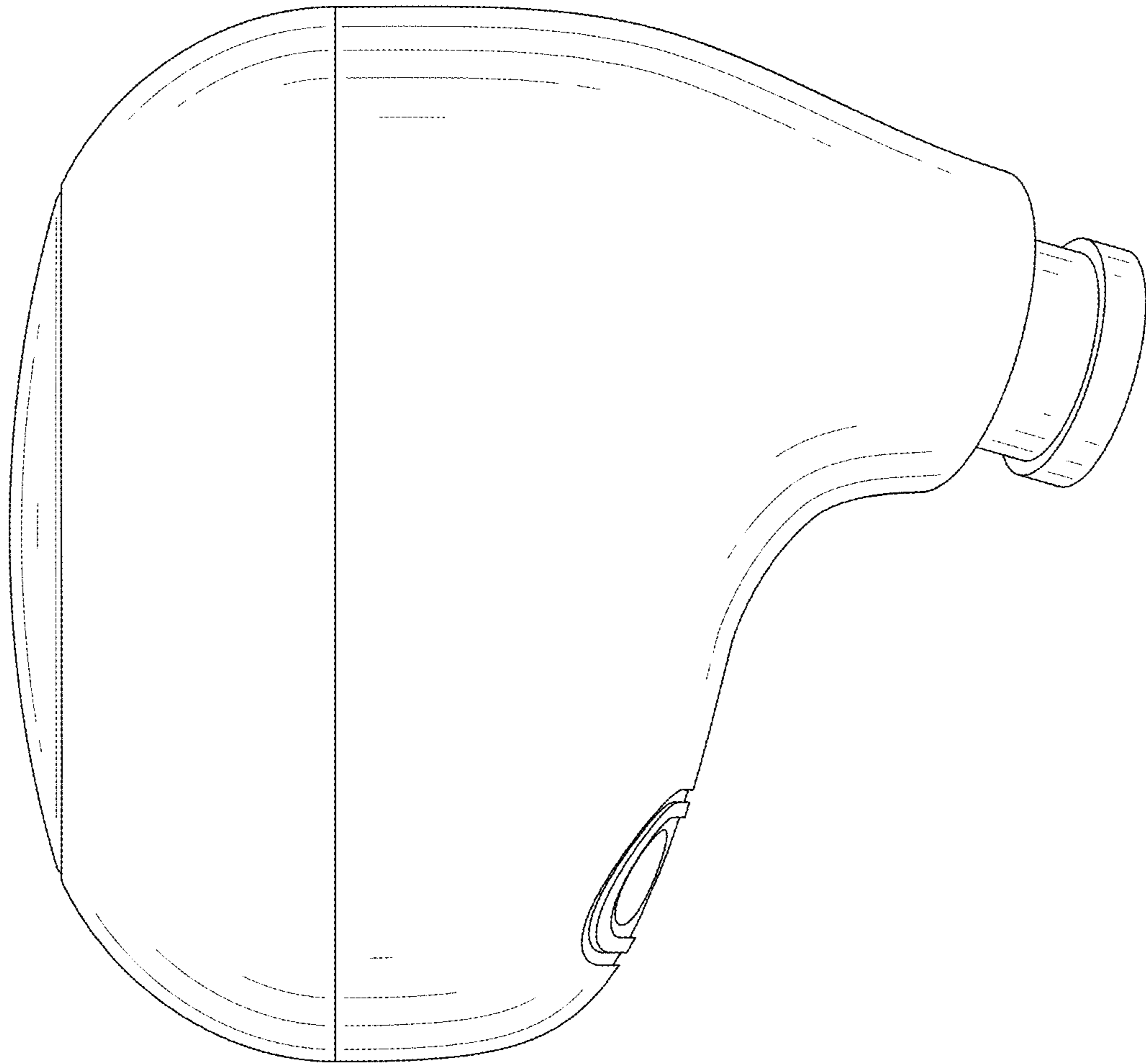

FIG. 20

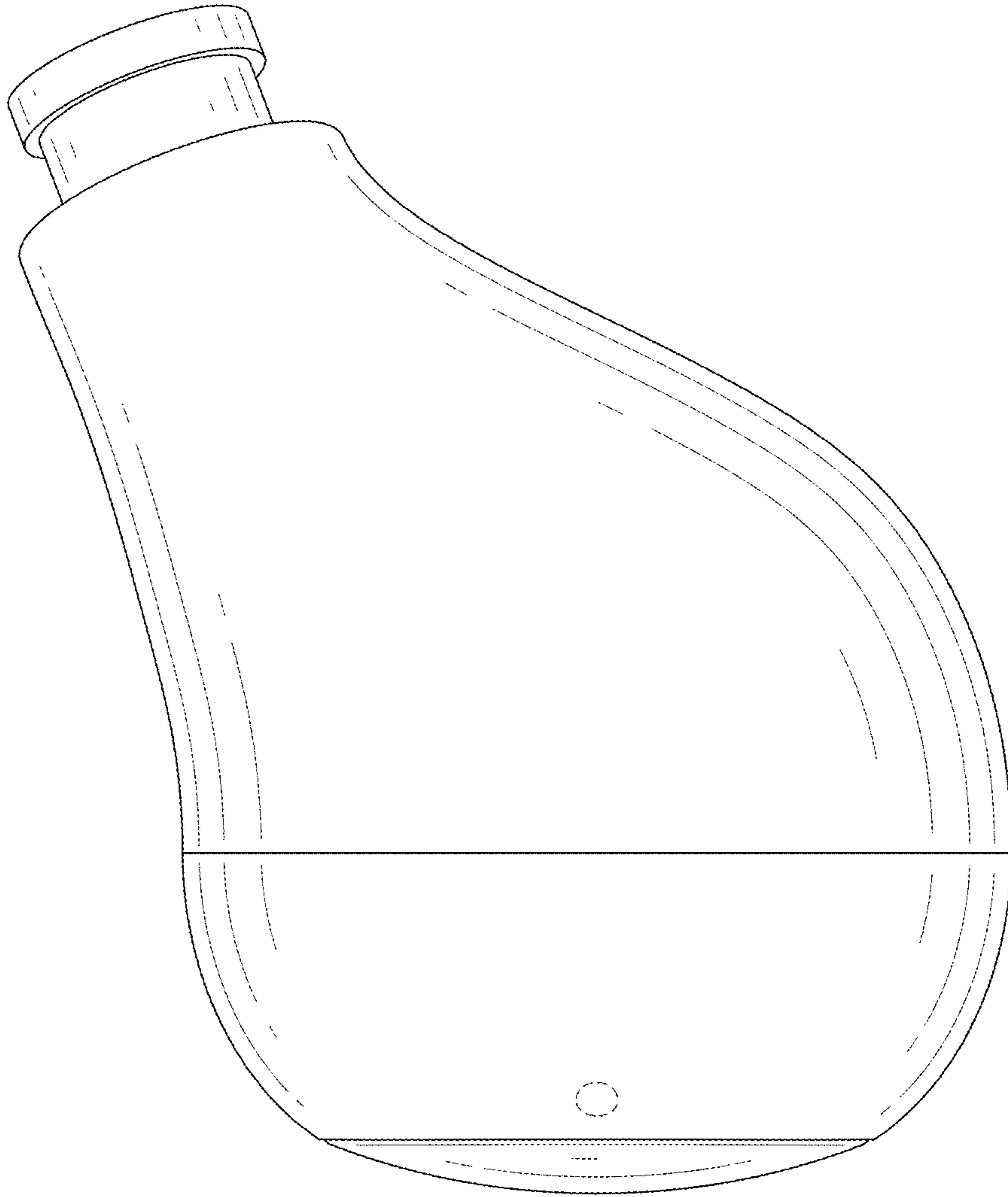

FIG. 21

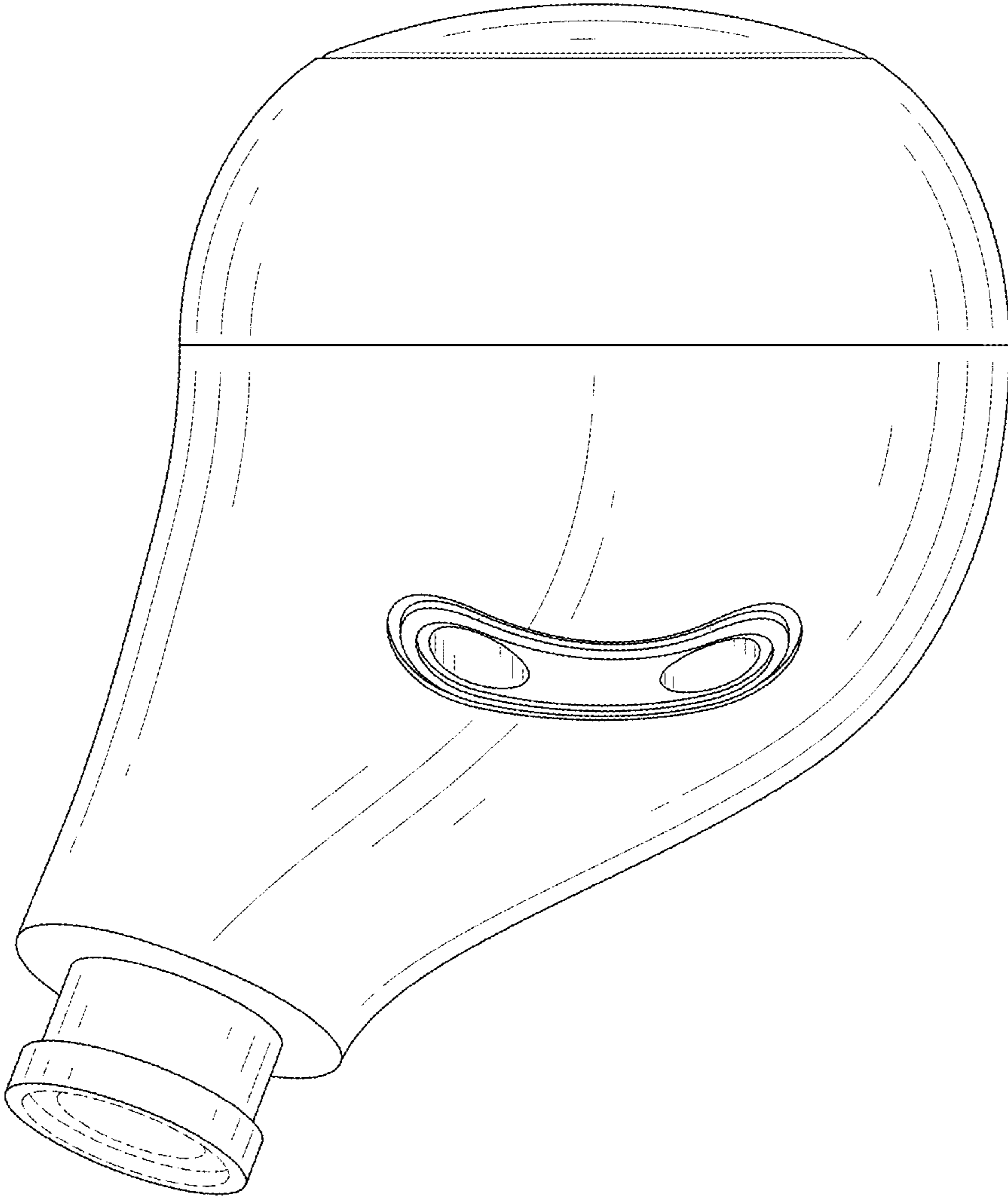

FIG. 22



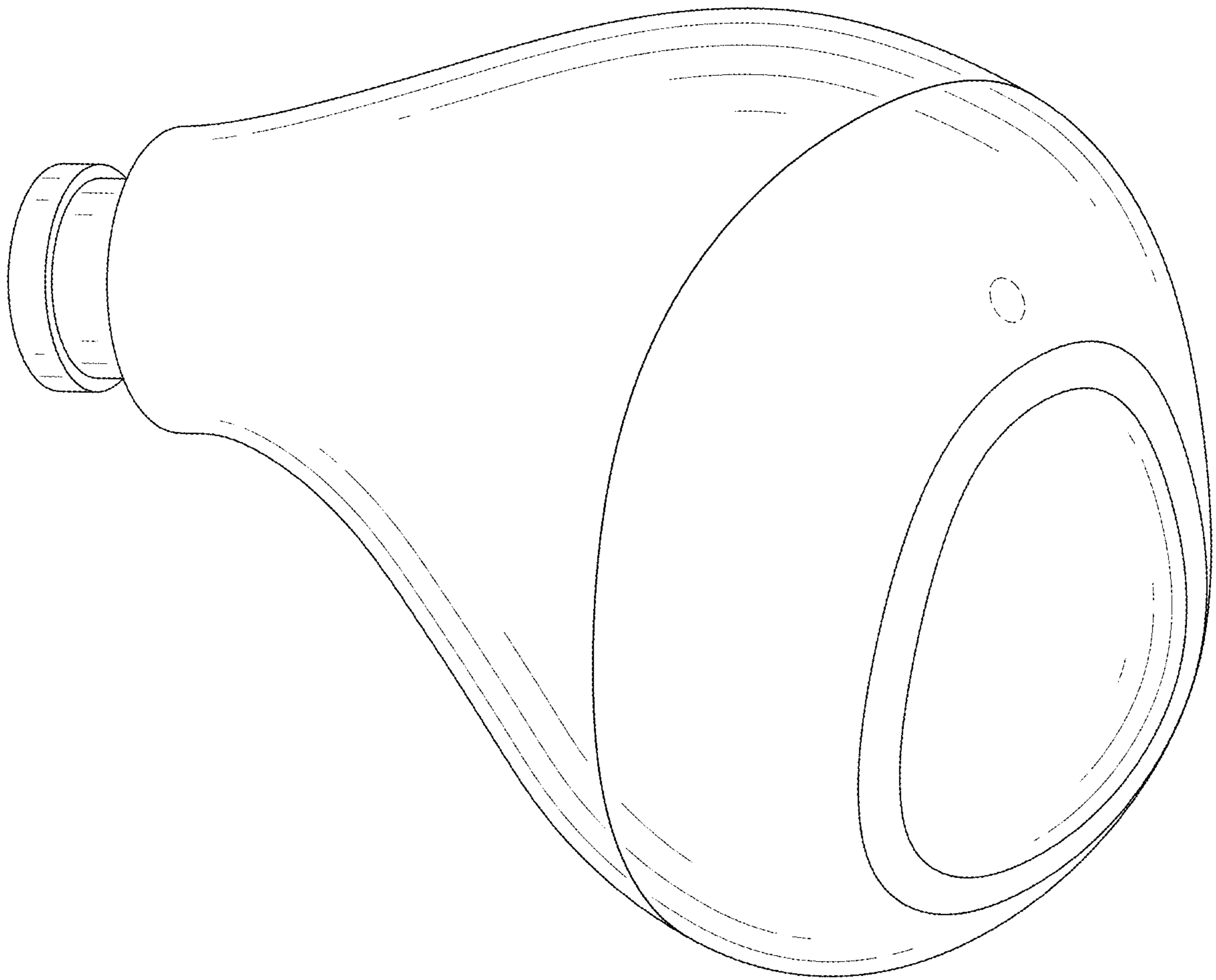

FIG. 23

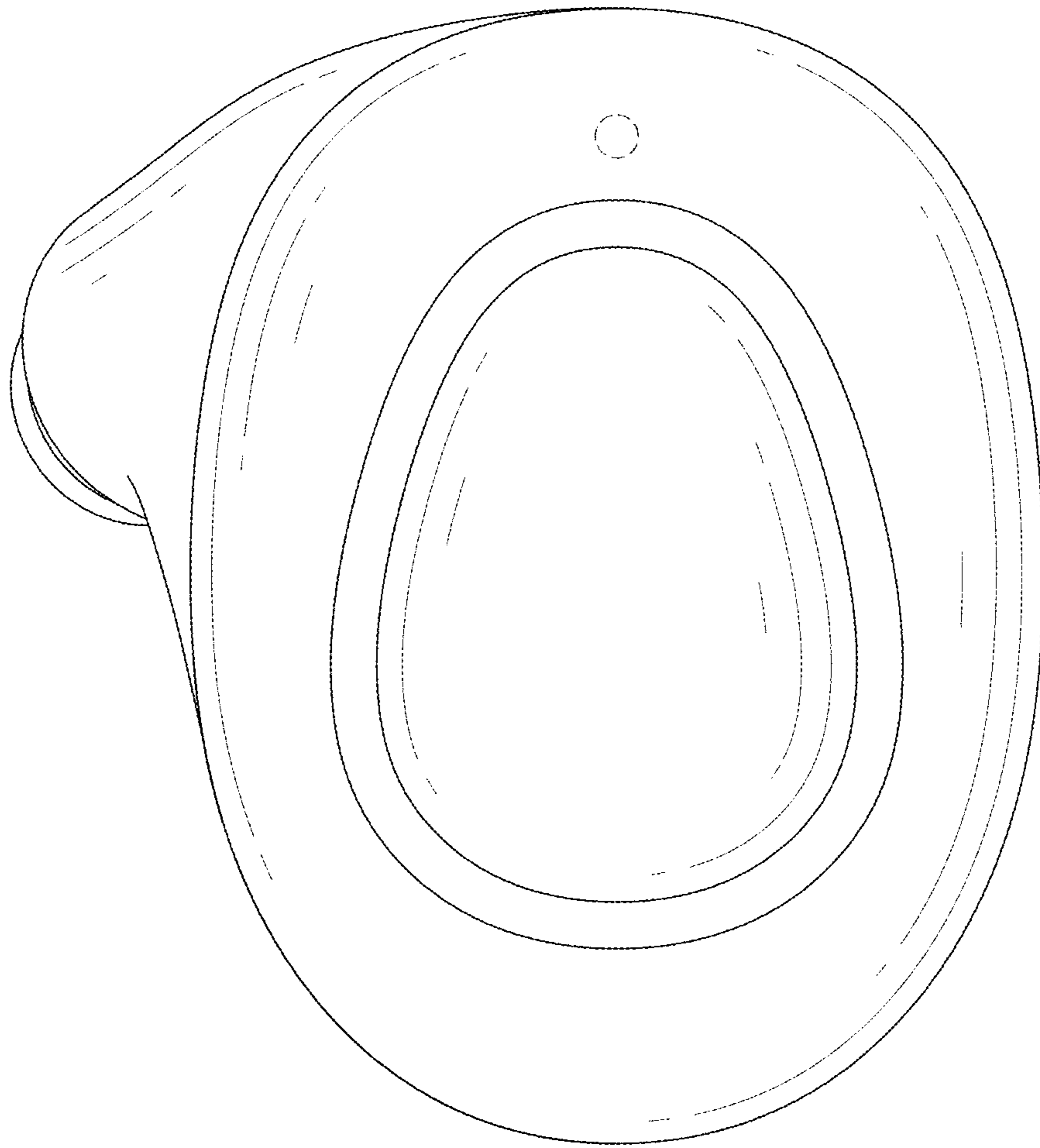

FIG. 24

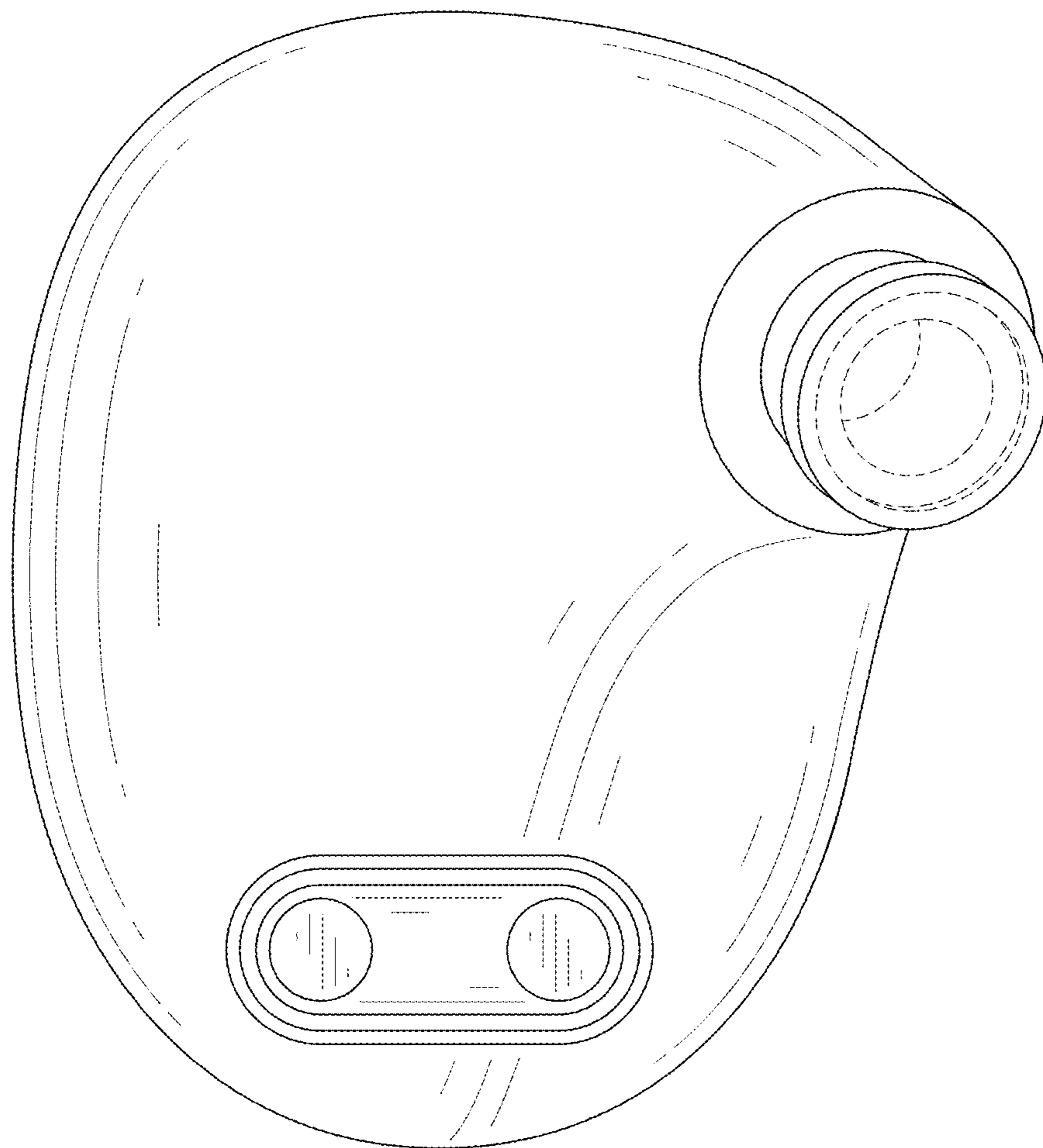

FIG. 25

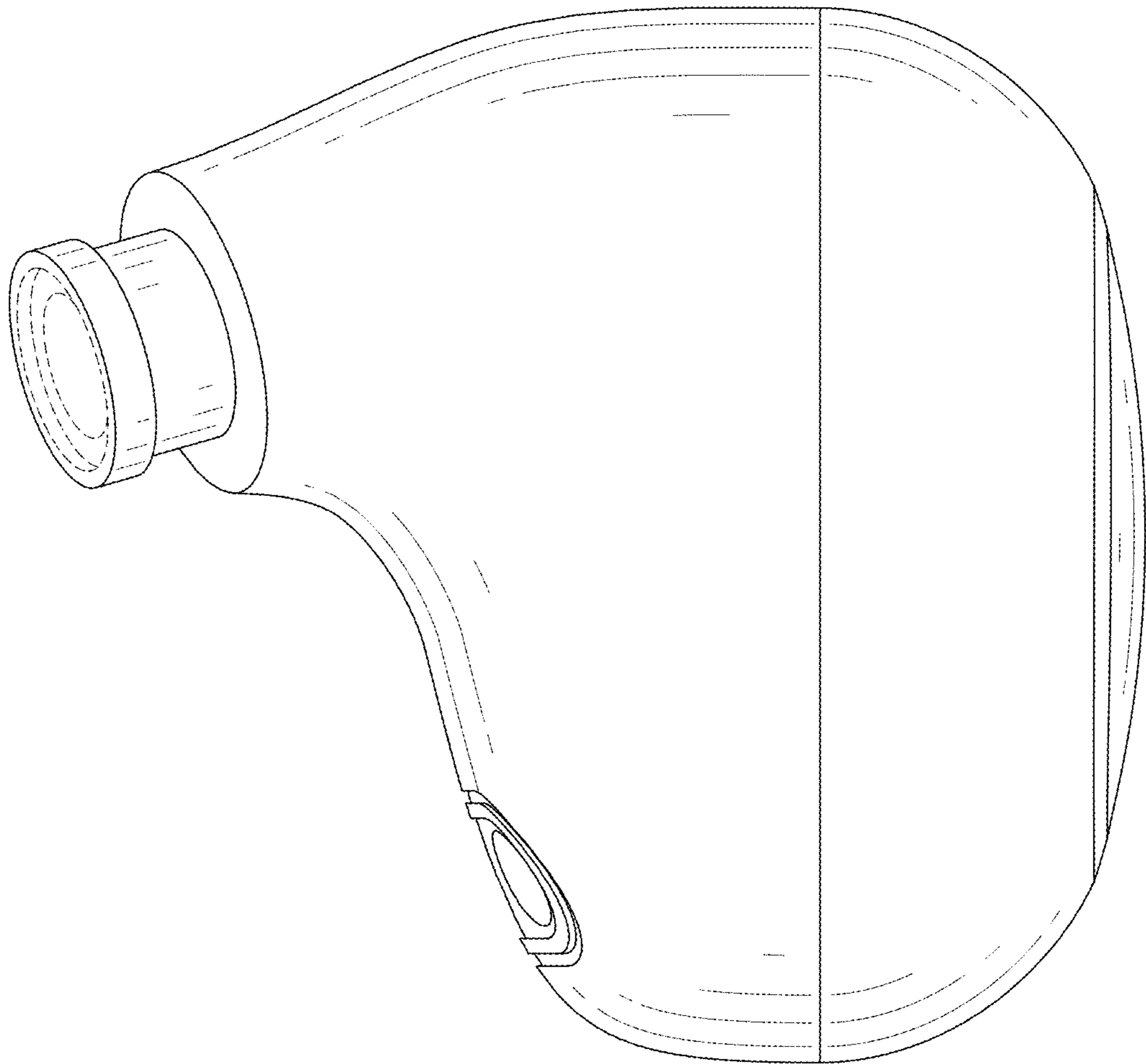

FIG. 26

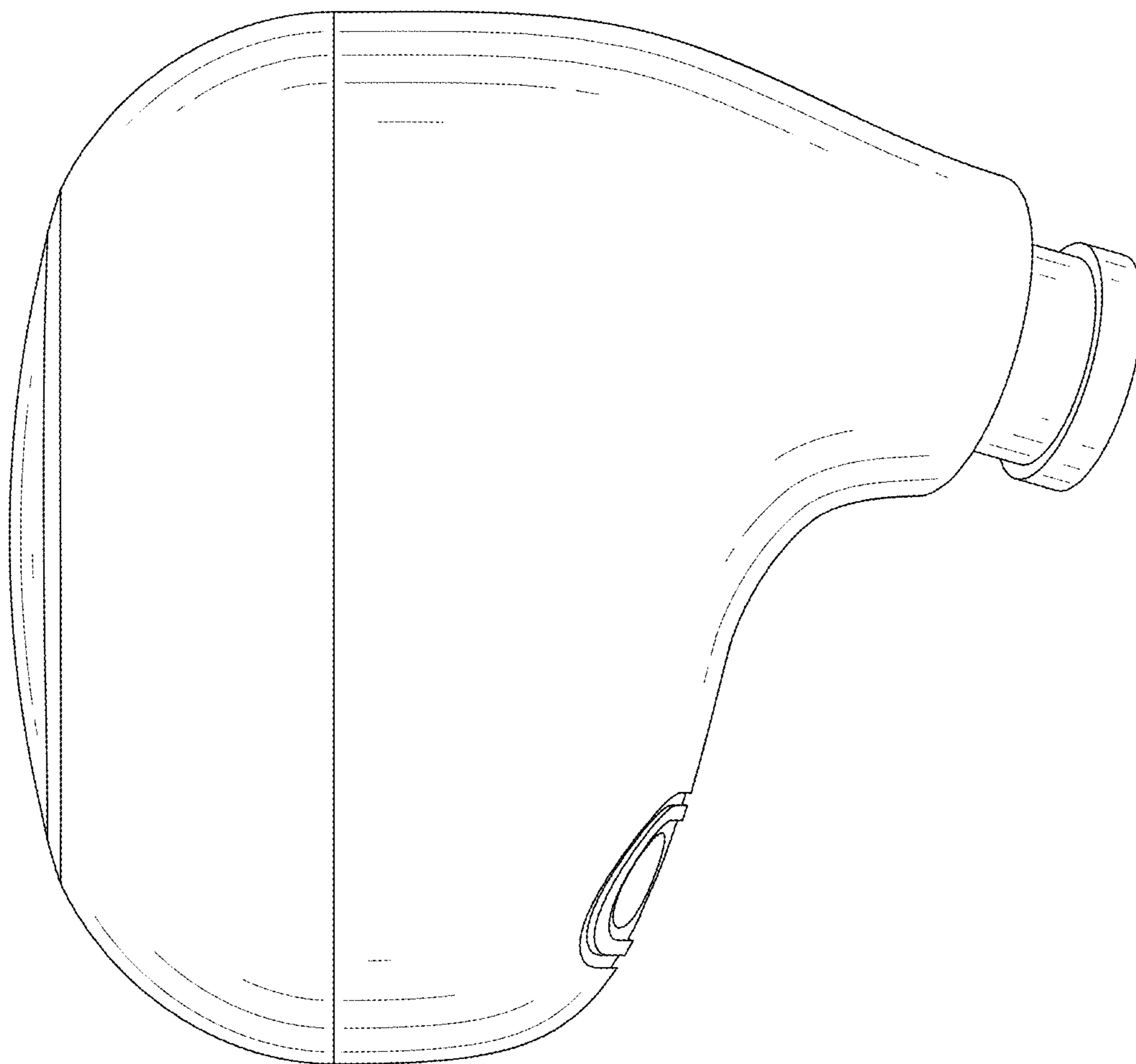

FIG. 27

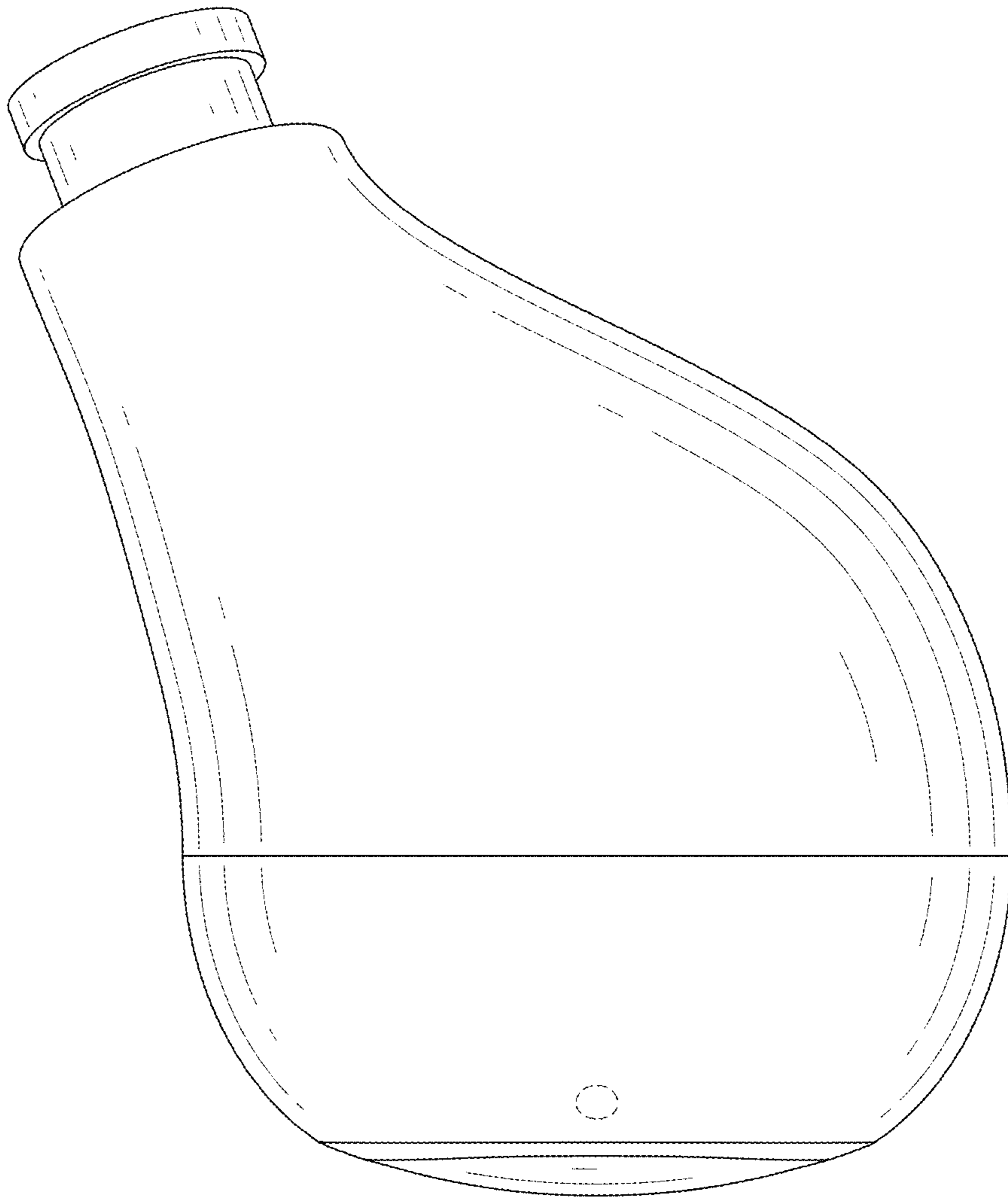

FIG. 28

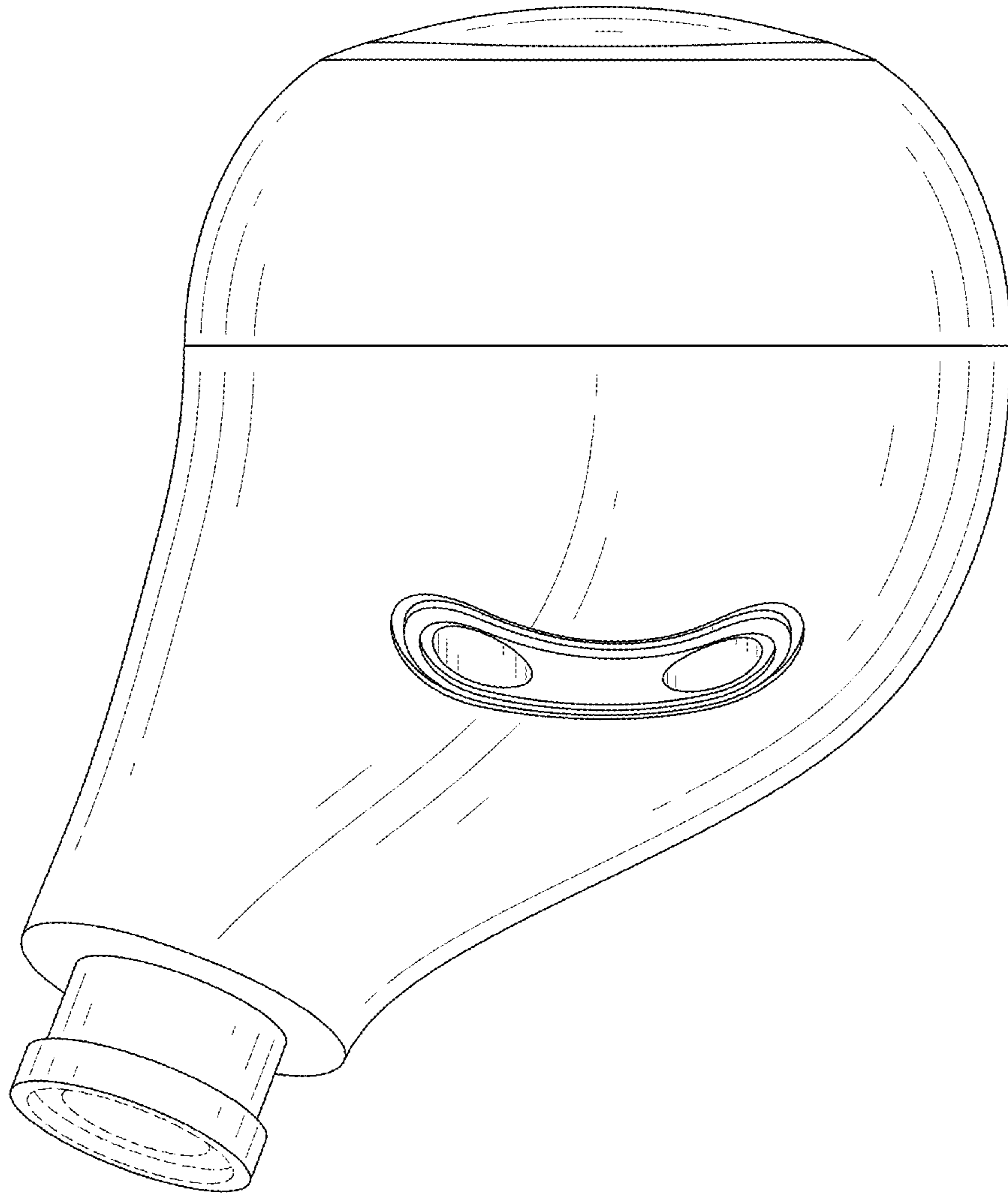

FIG. 29

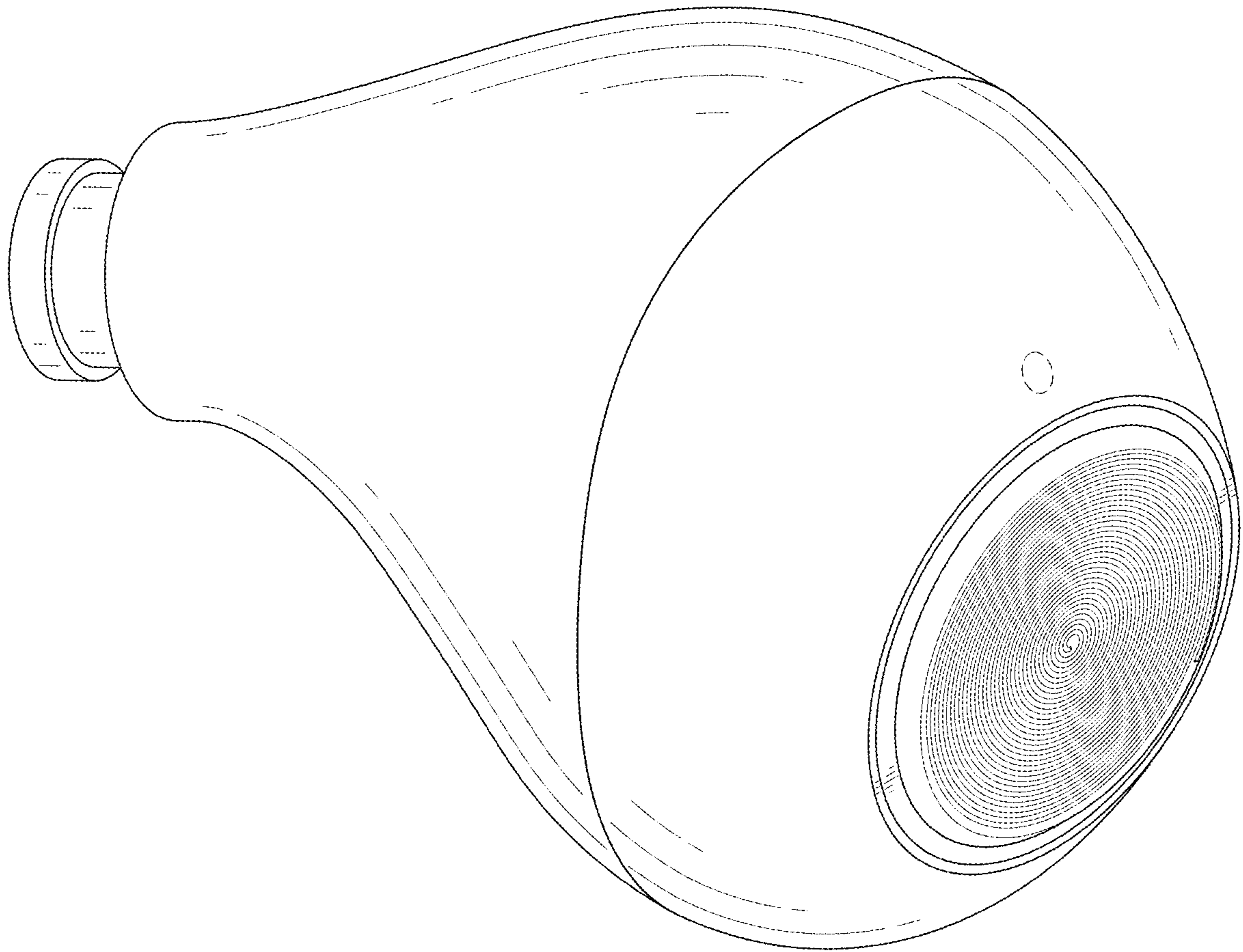

FIG. 30



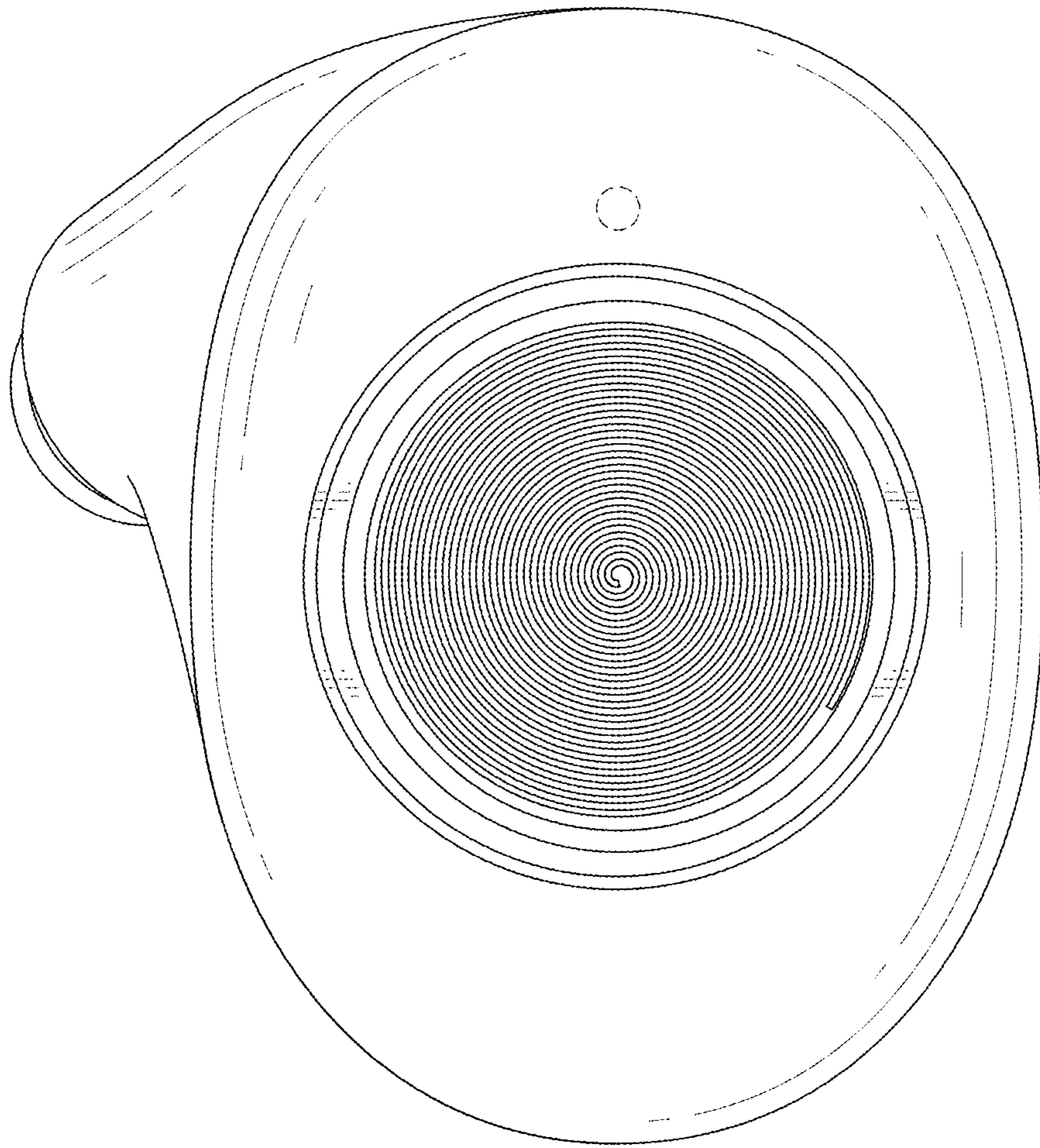

FIG. 31

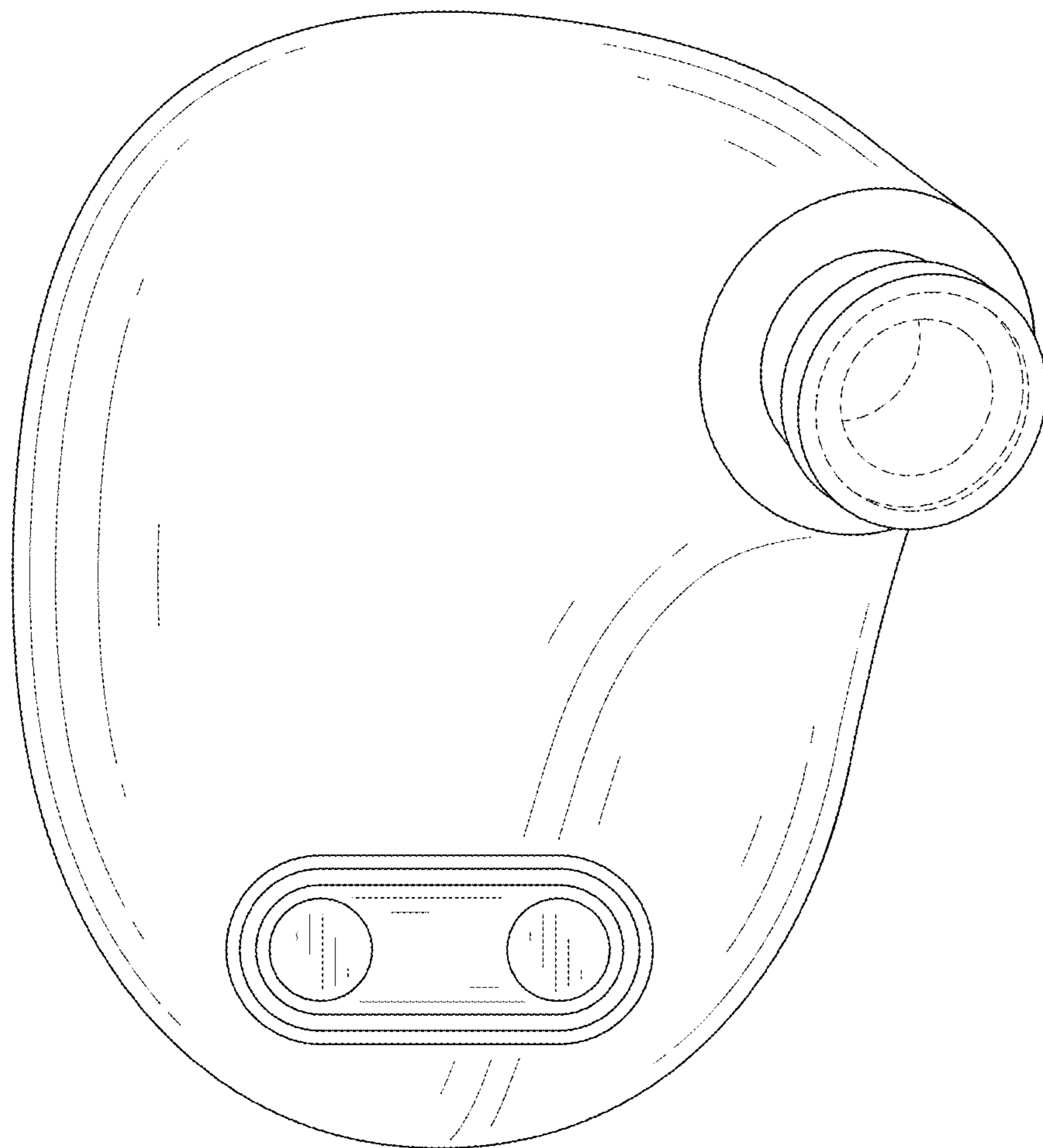

FIG. 32

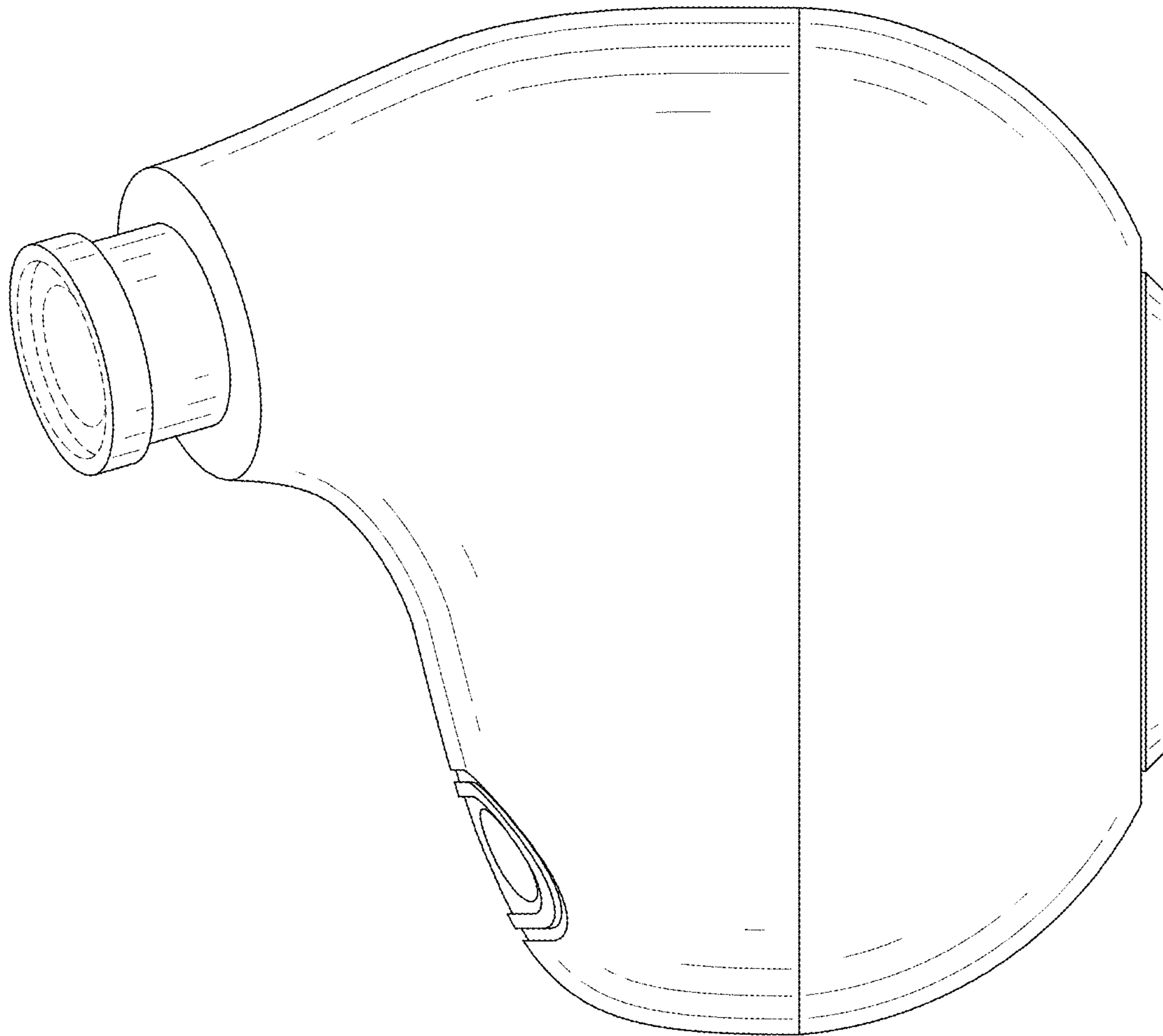

FIG. 33

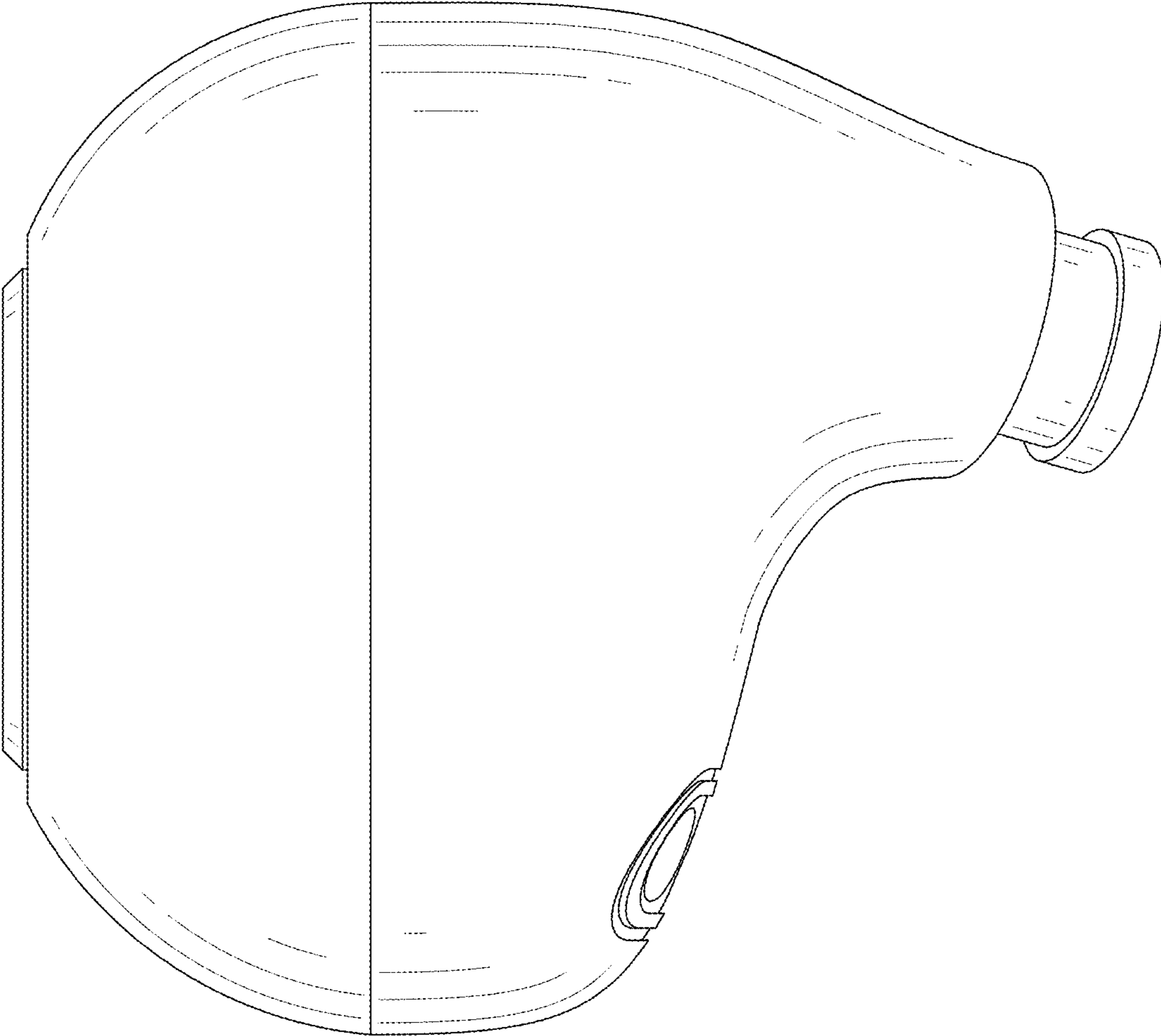

FIG. 34

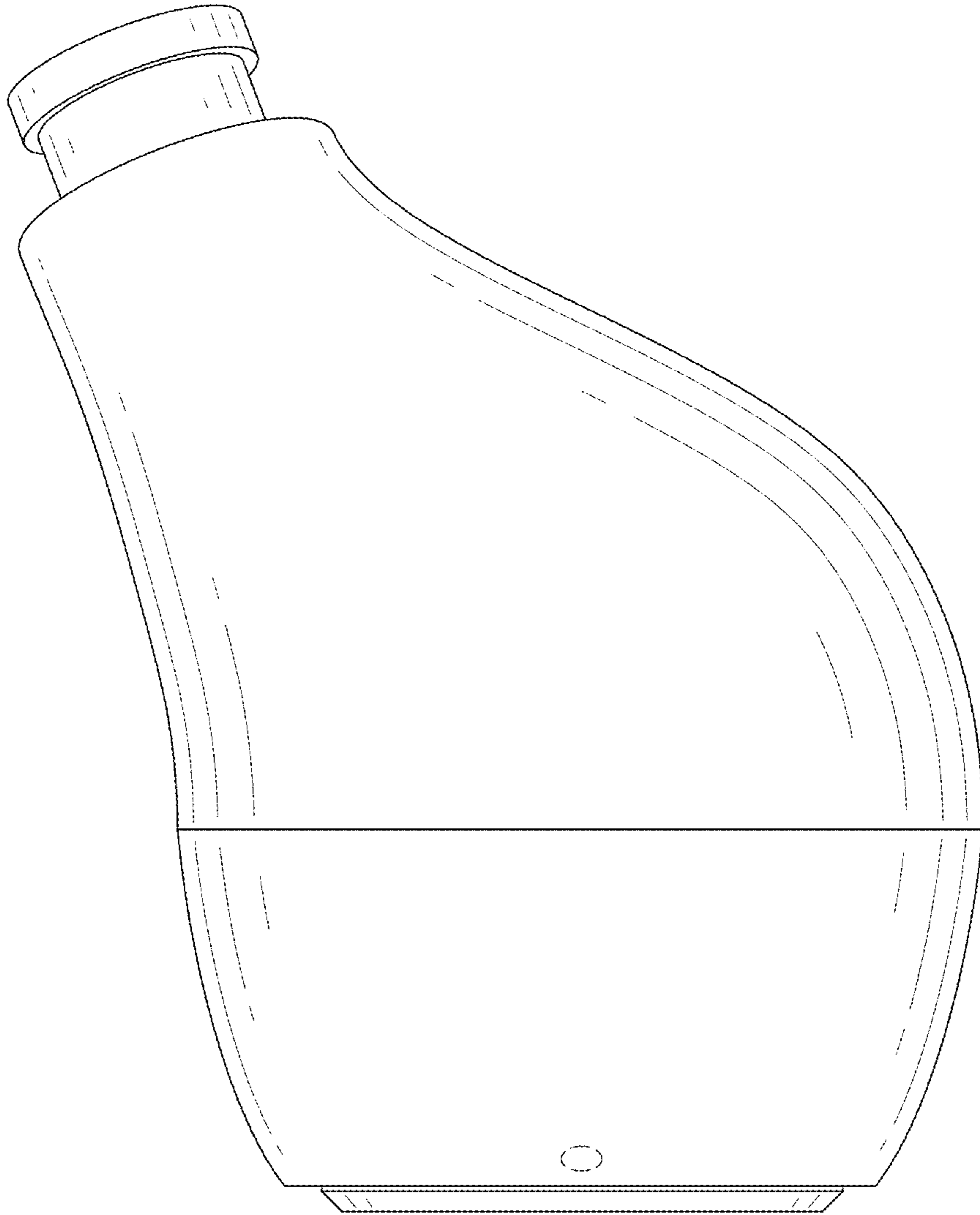

FIG. 35

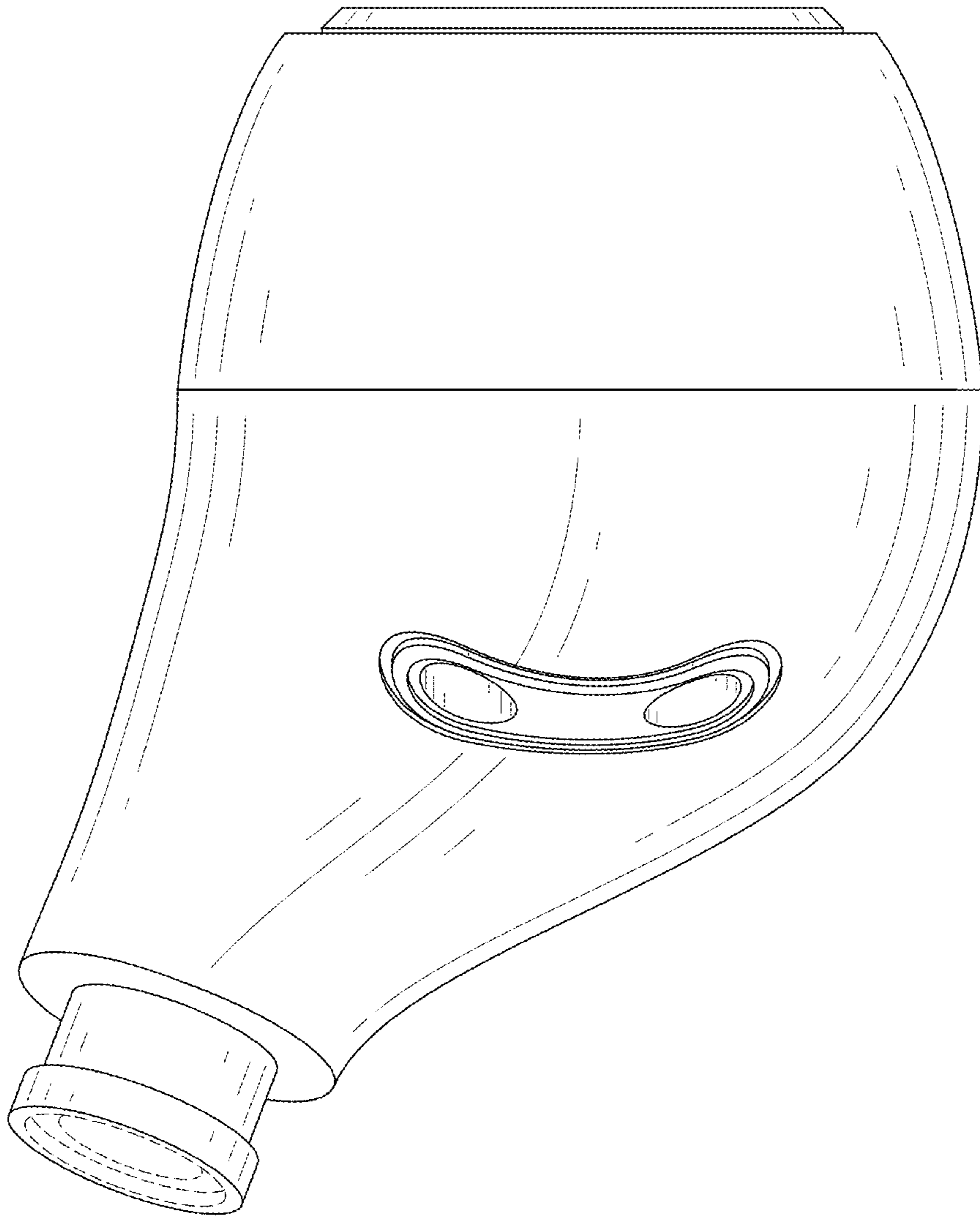

FIG. 36

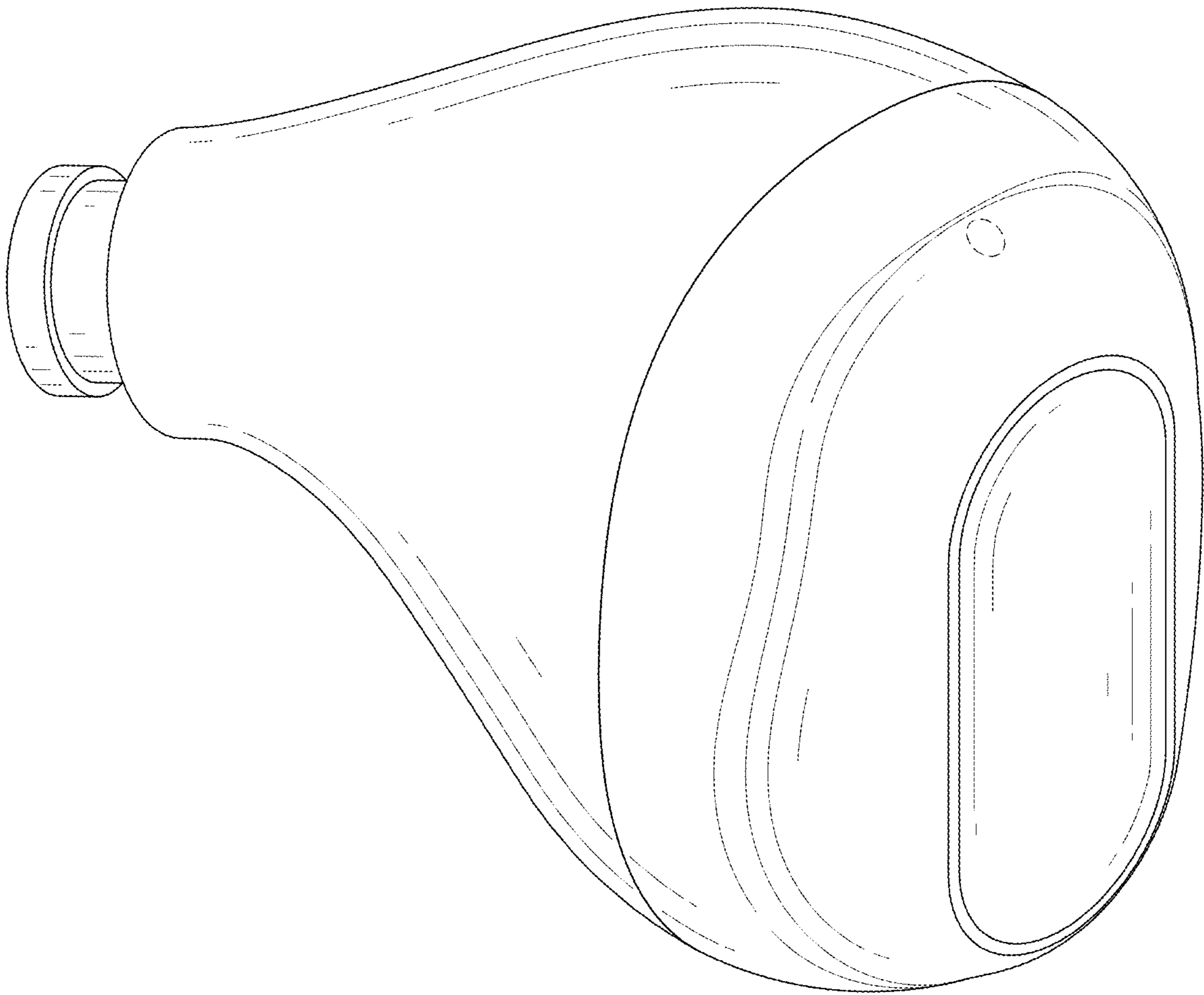

FIG. 37

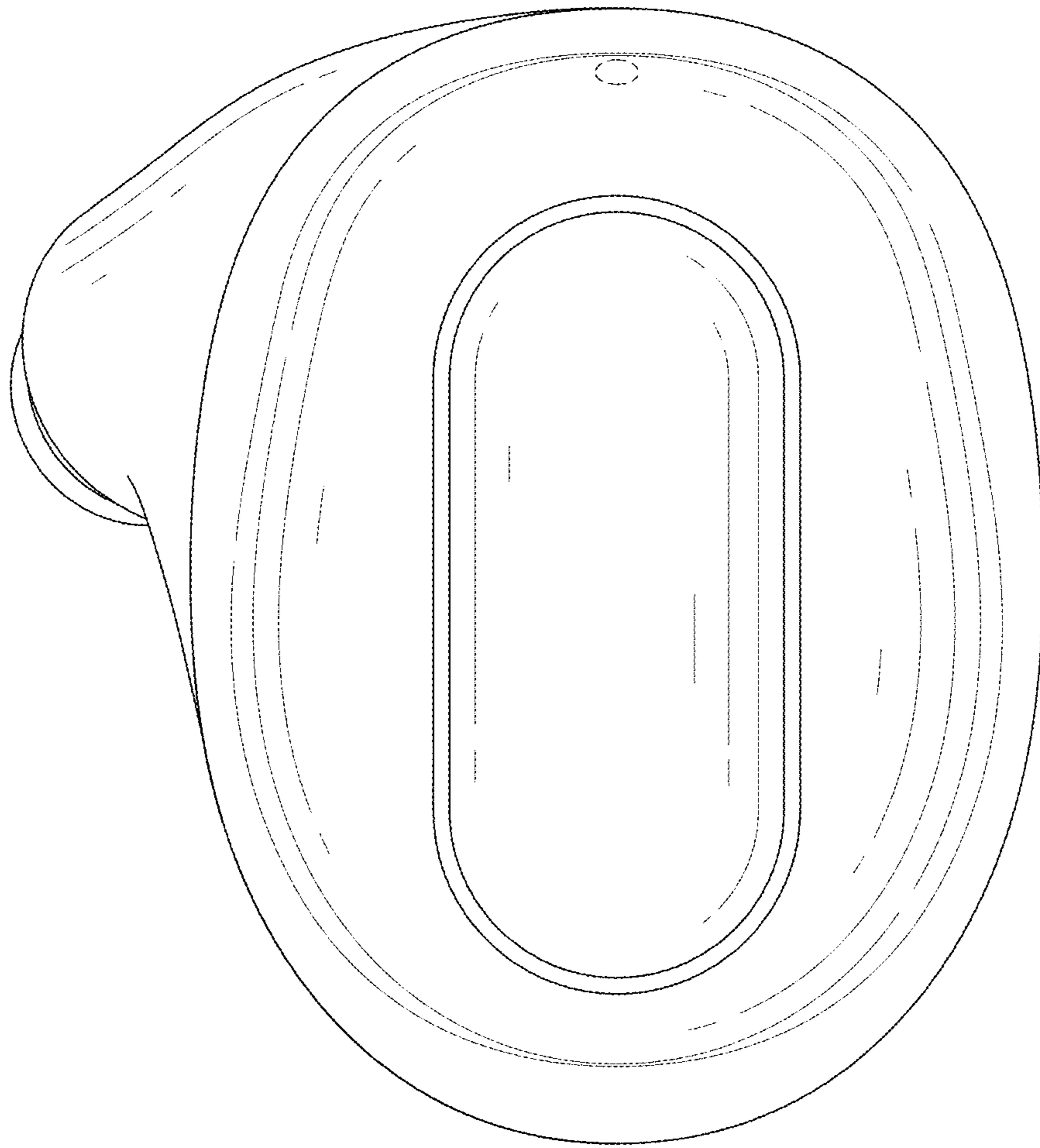

FIG. 38



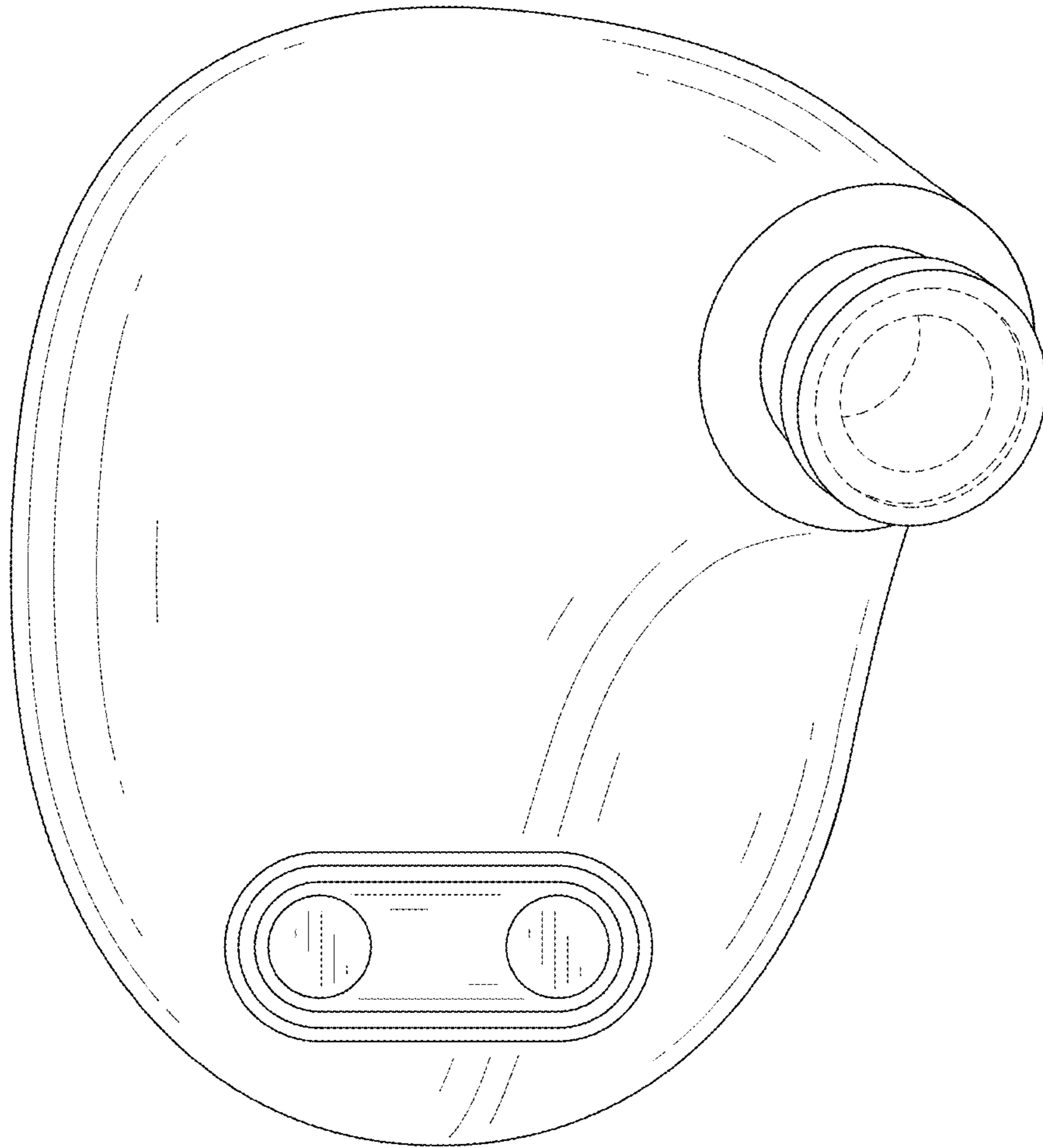

FIG. 39

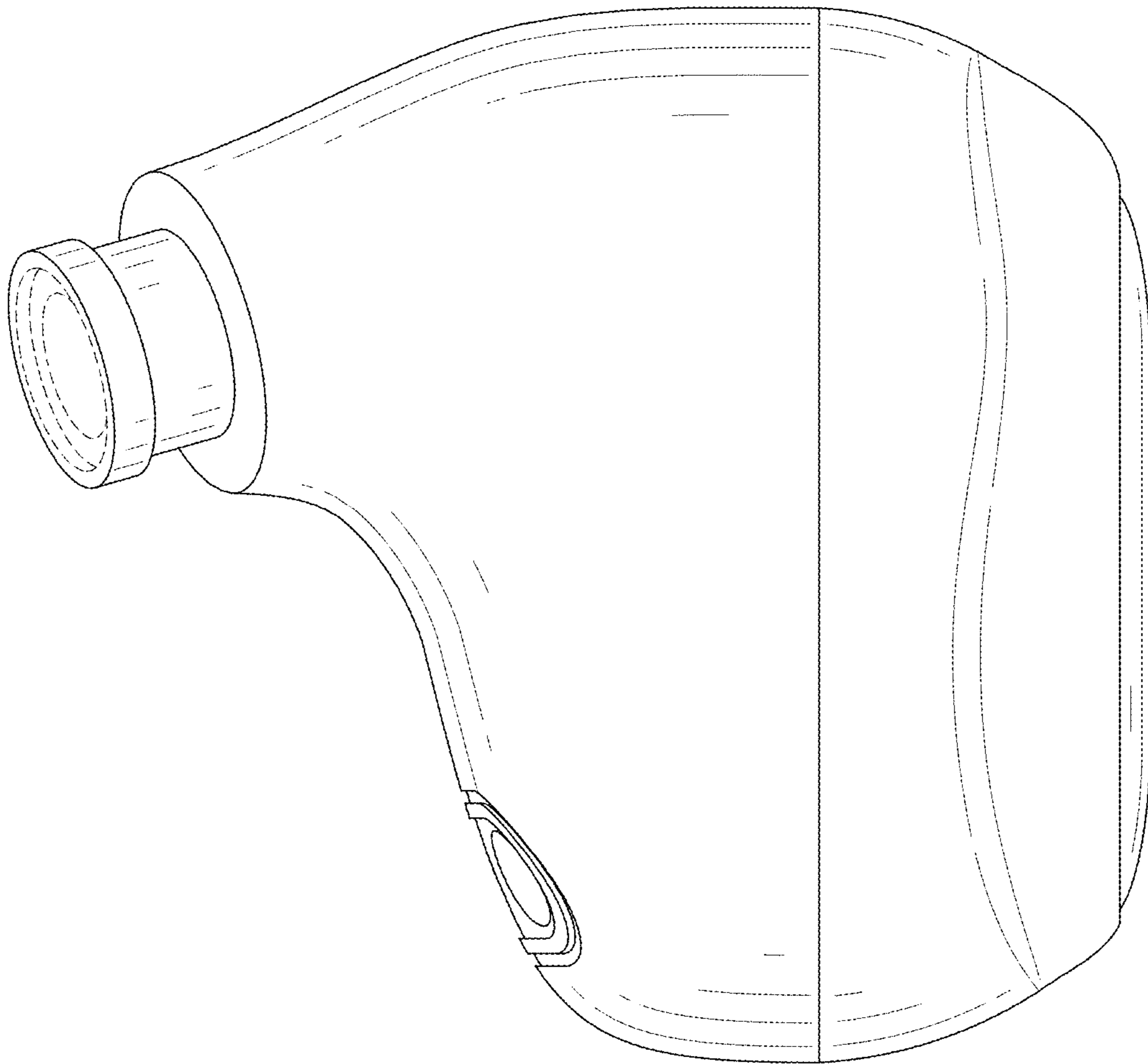

FIG. 40

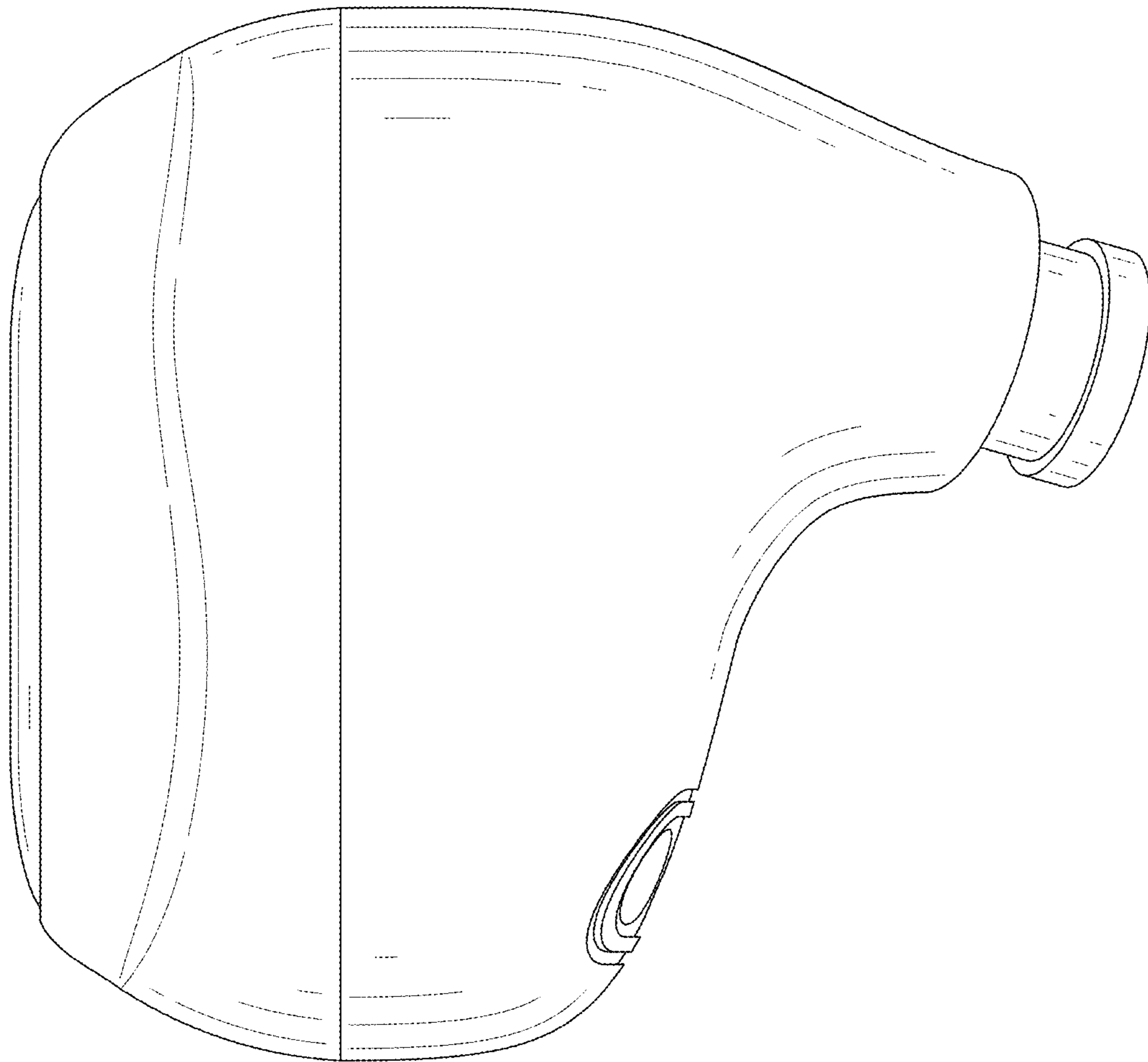

FIG. 41

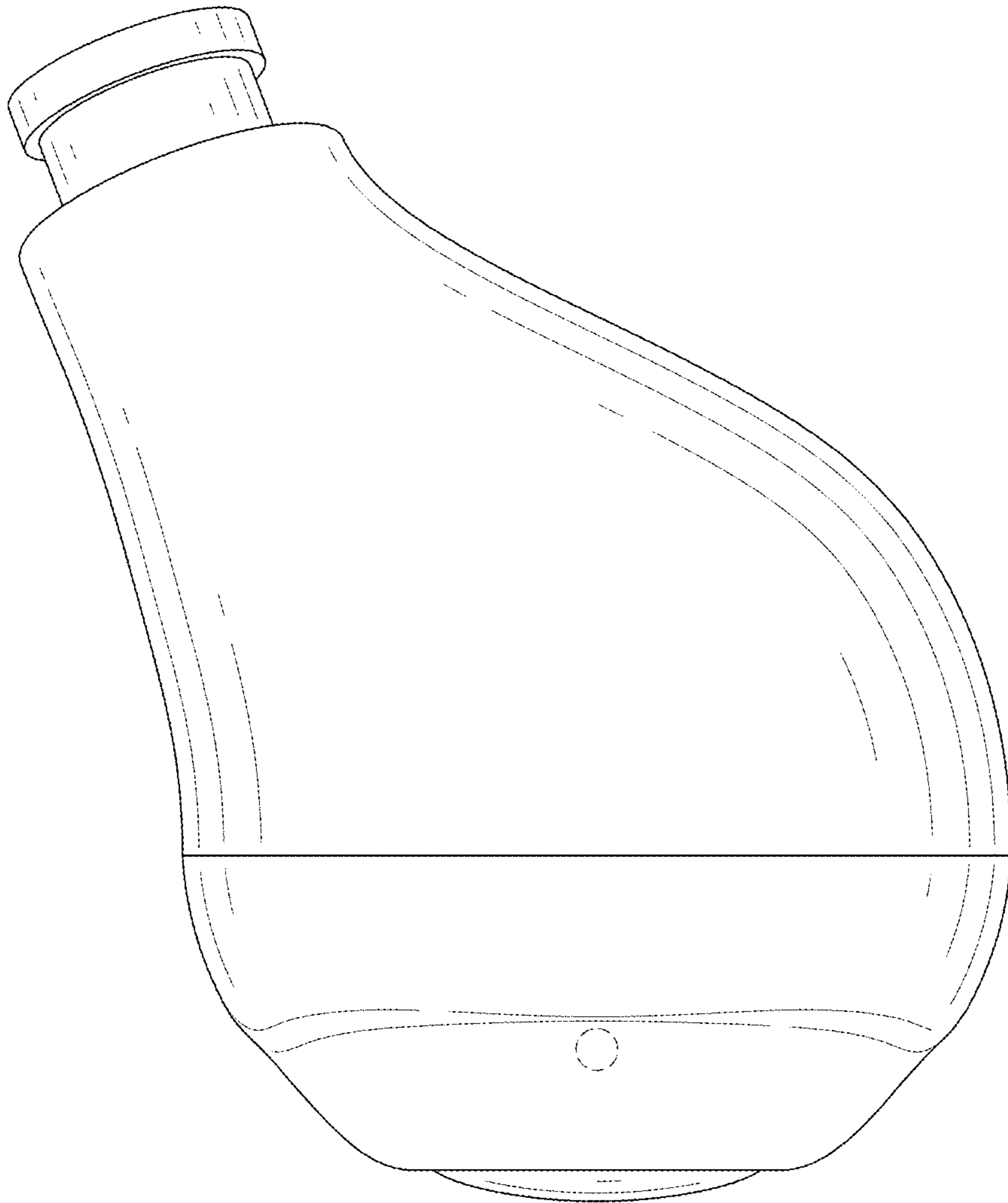

FIG. 42

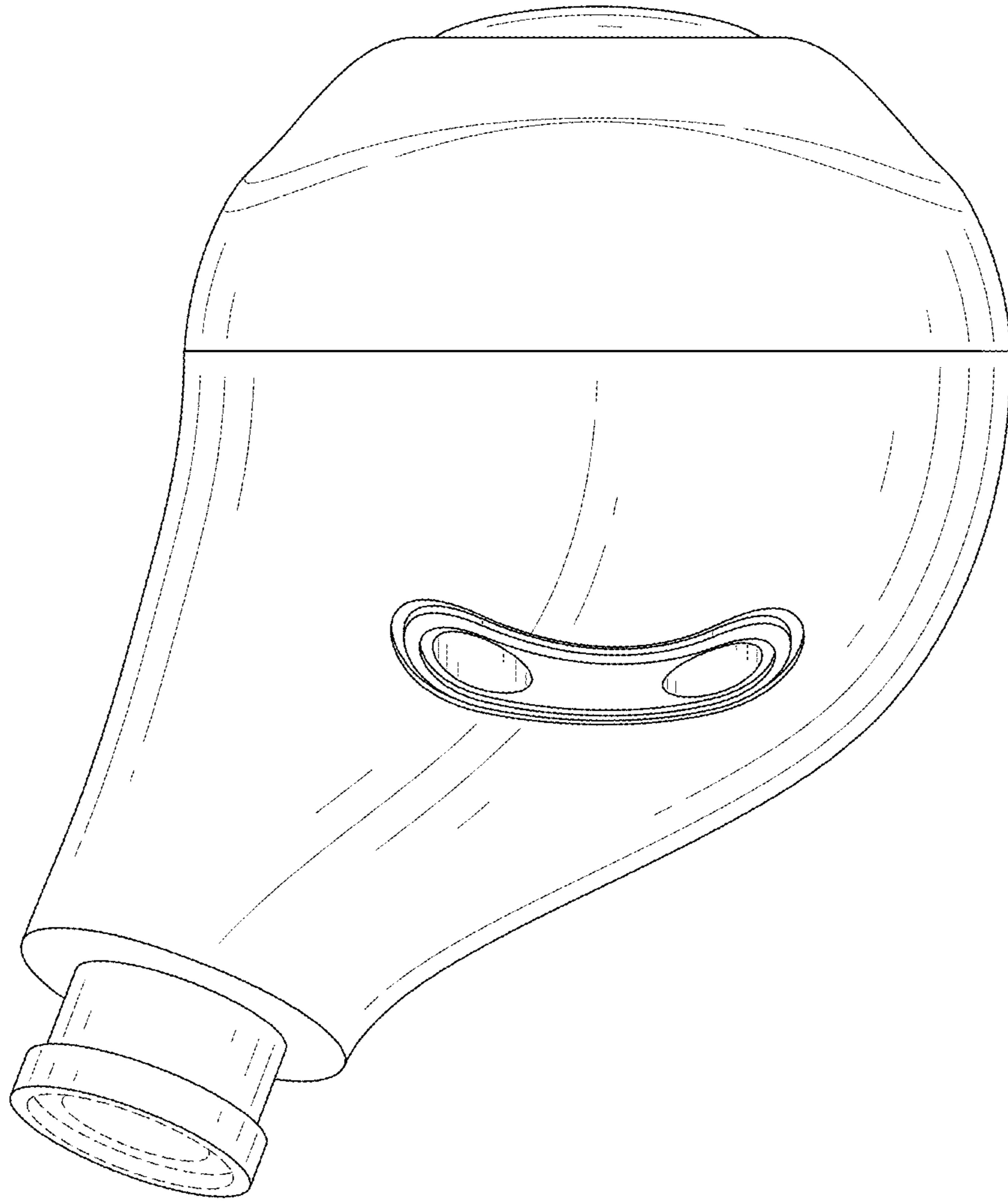

FIG. 43

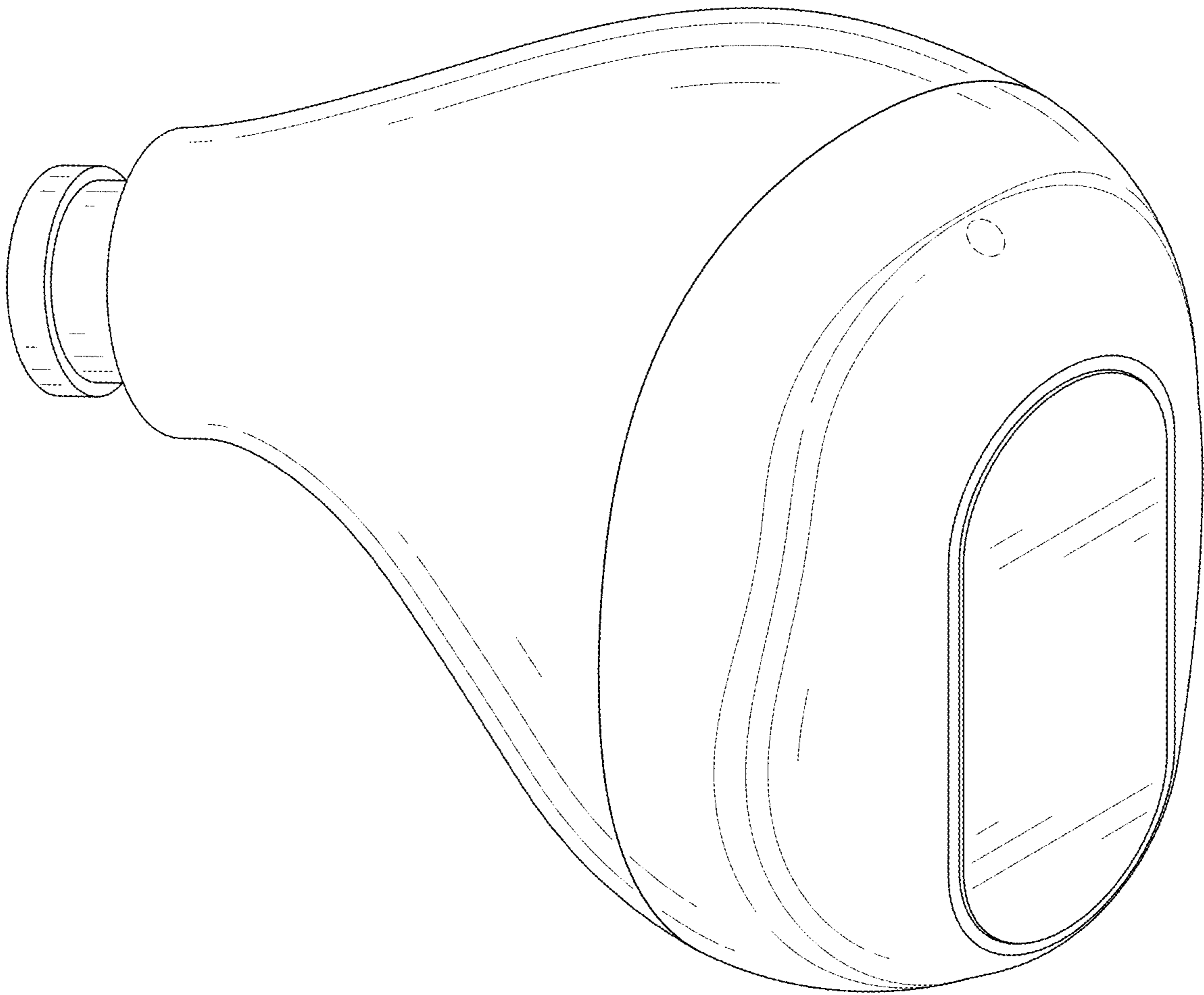

FIG. 44

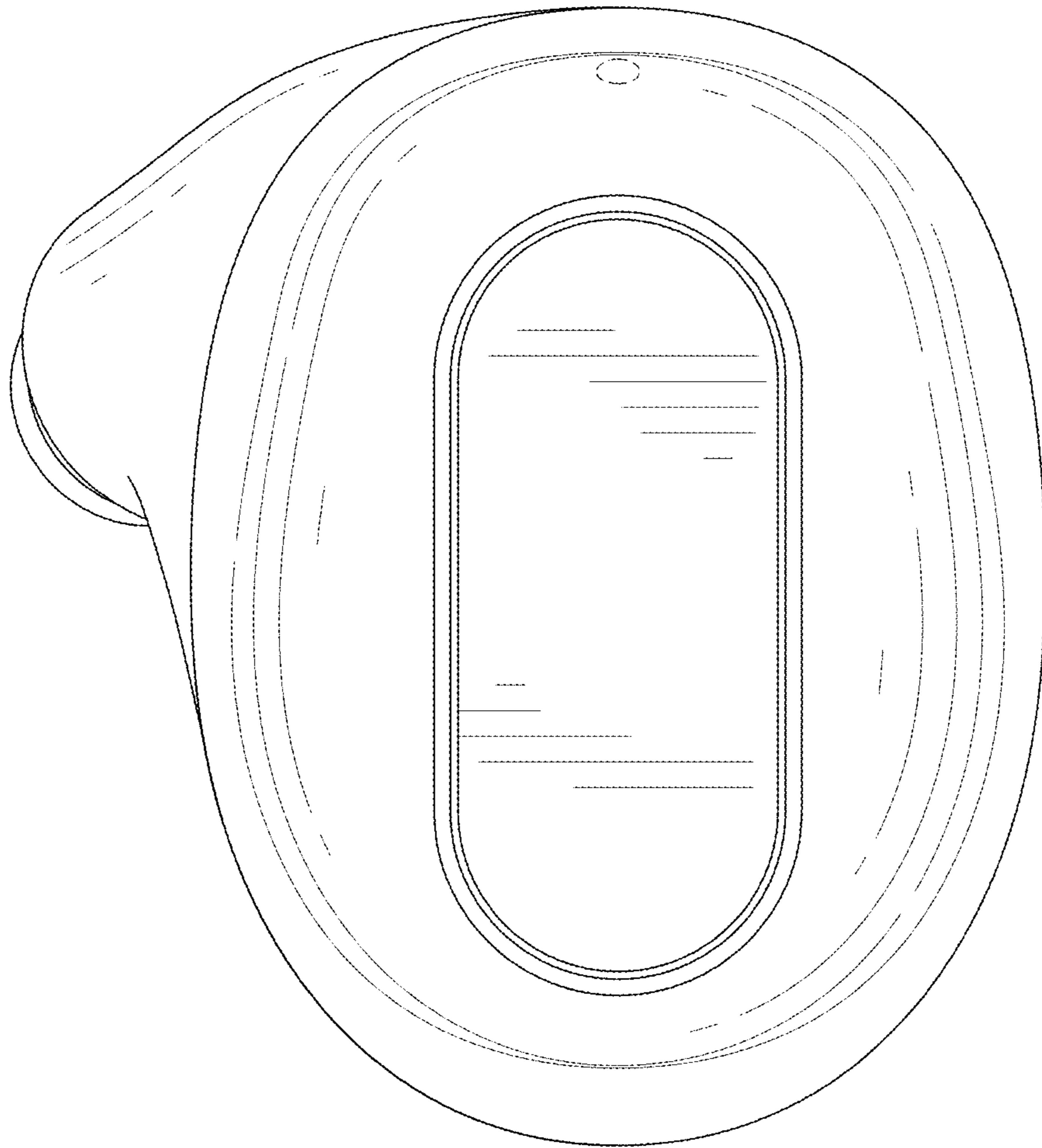

FIG. 45

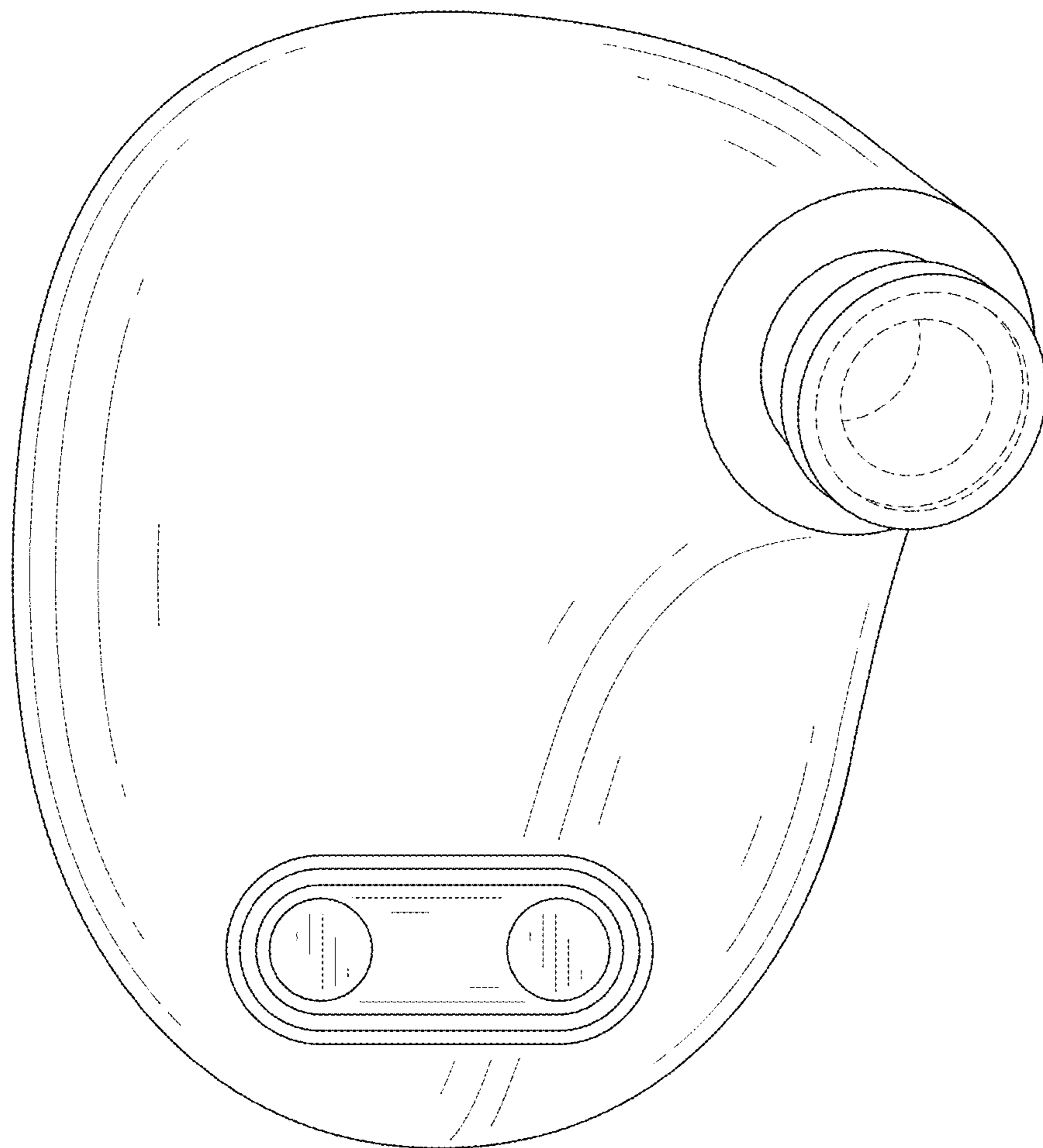

FIG. 46



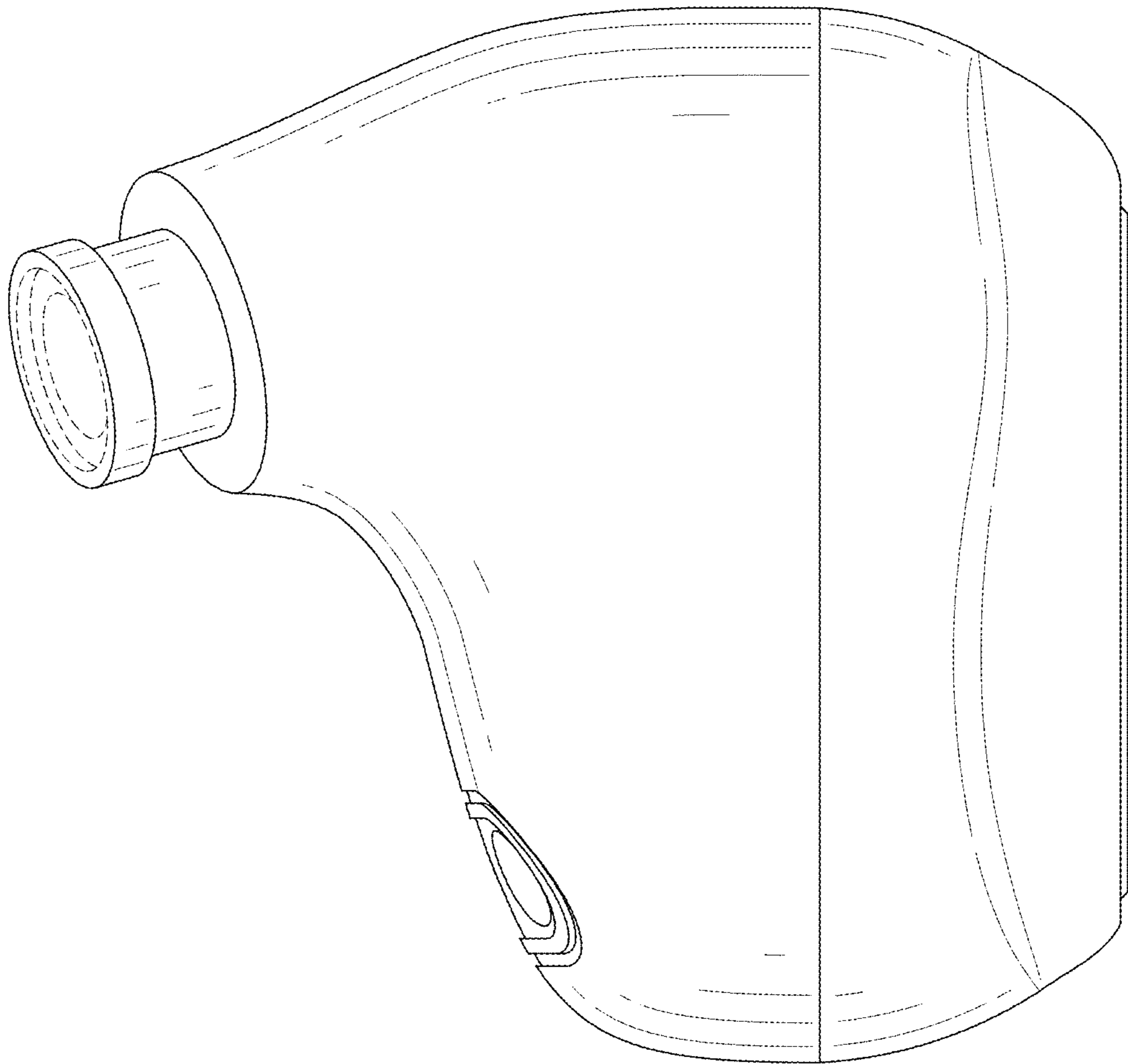

FIG. 47

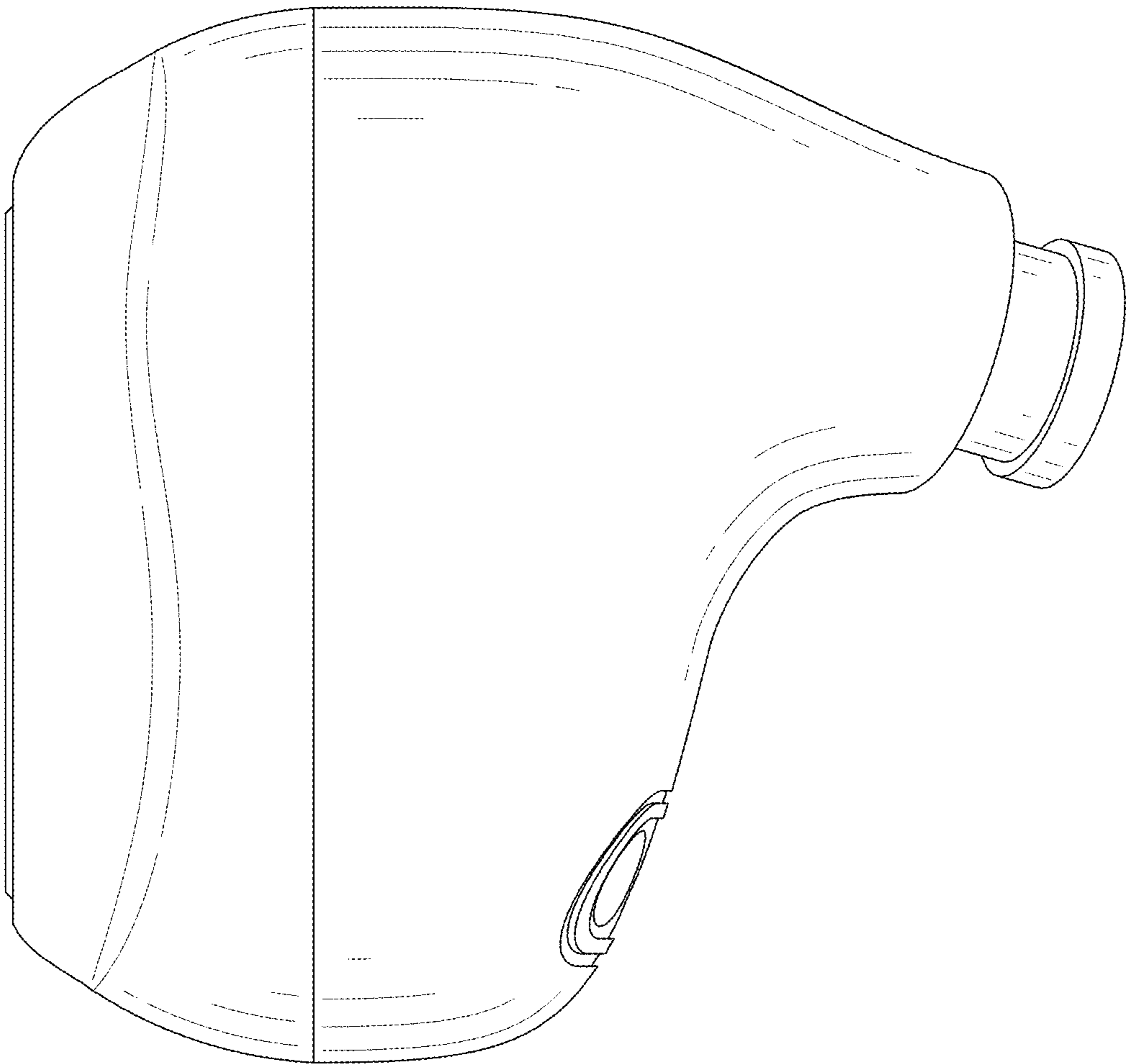

FIG. 48

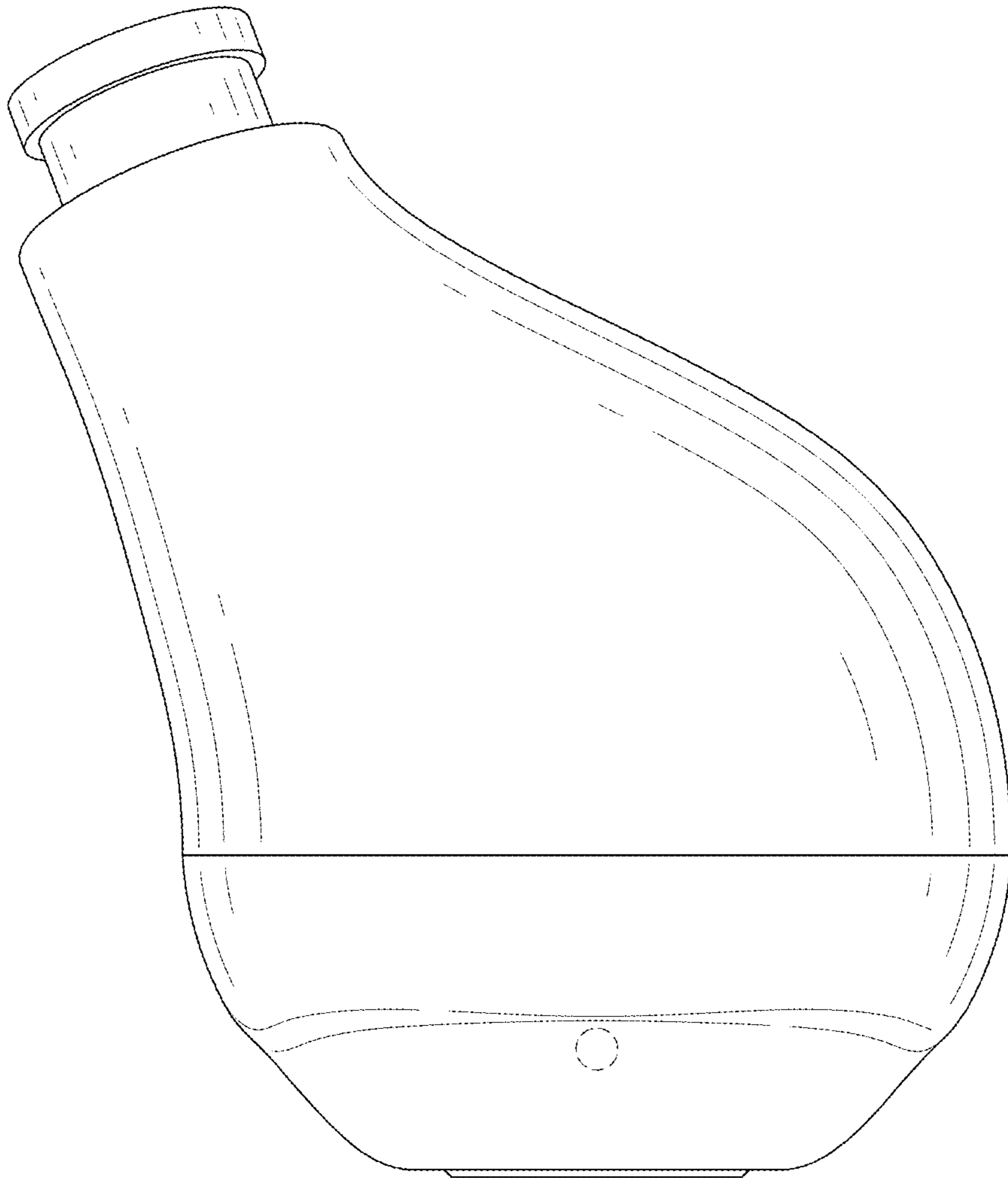

FIG. 49

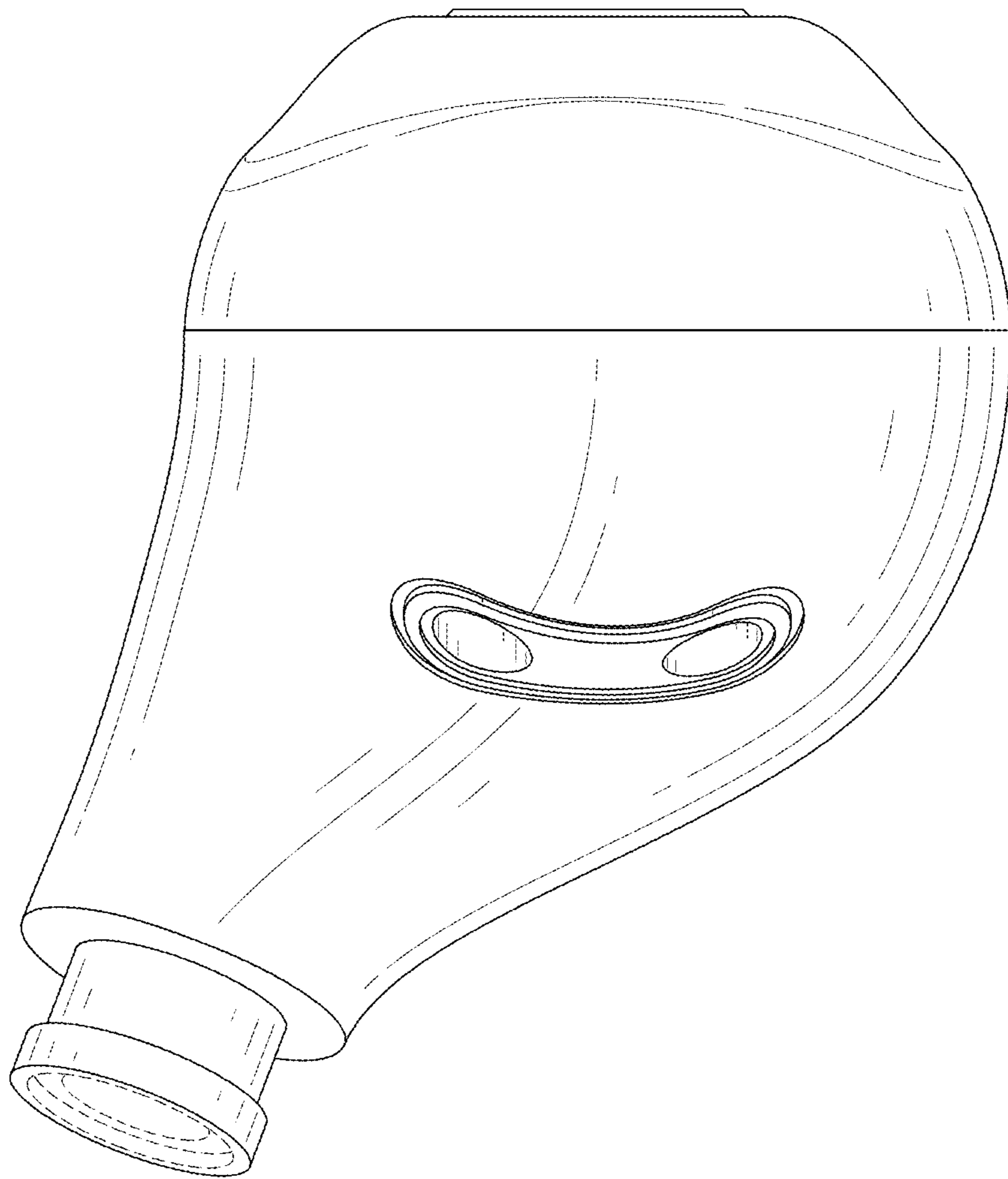

FIG. 50

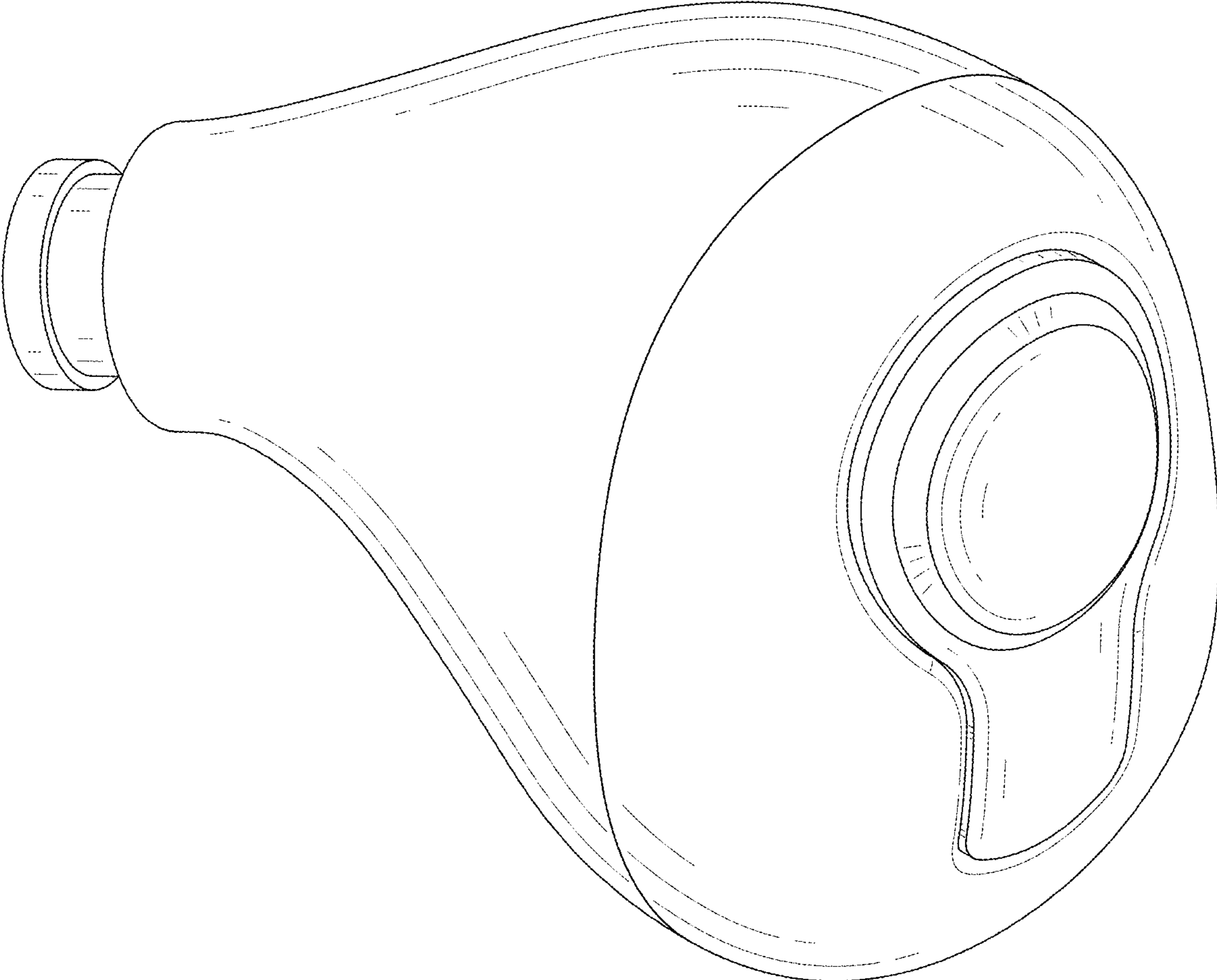

FIG. 51

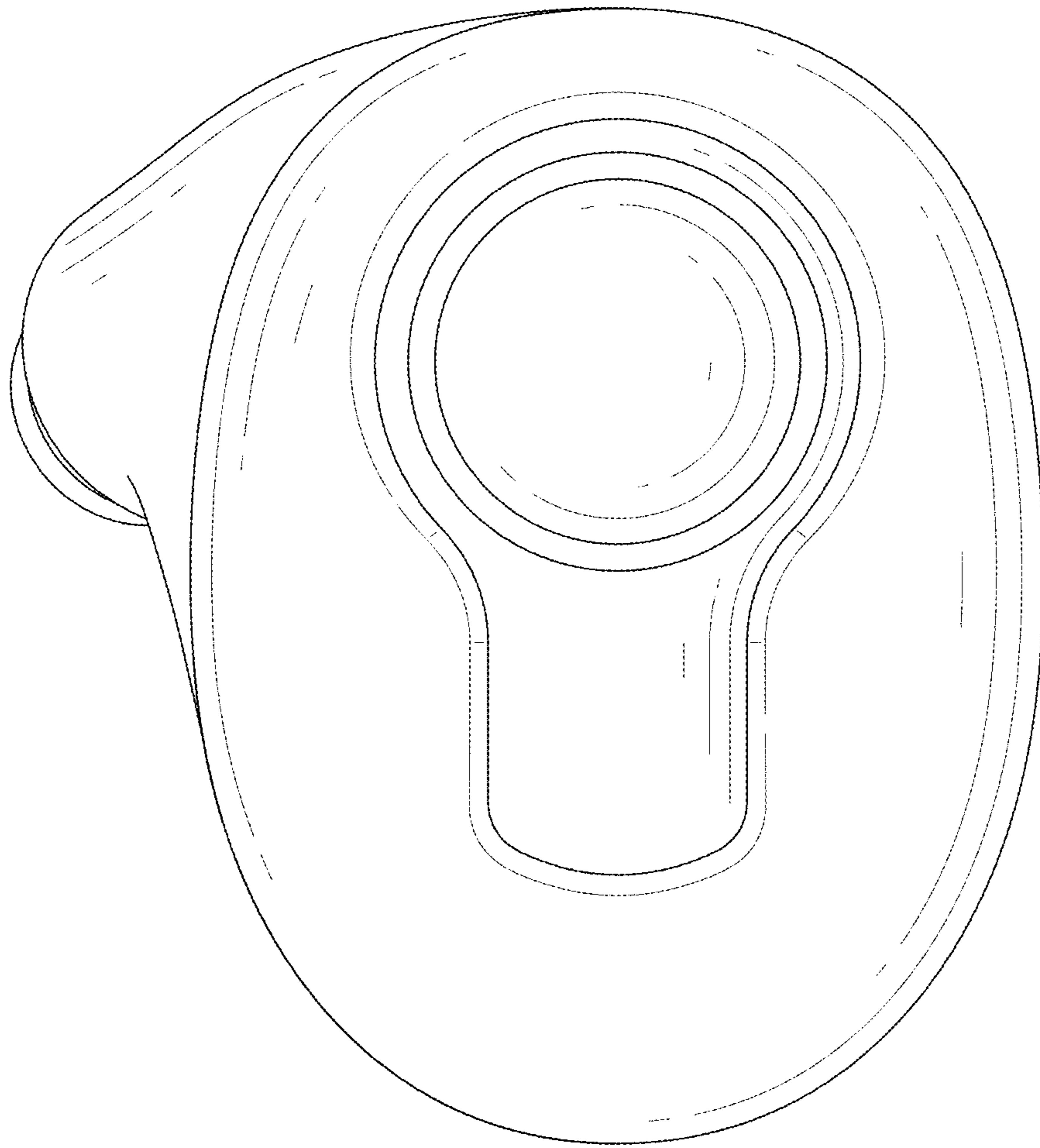

FIG. 52

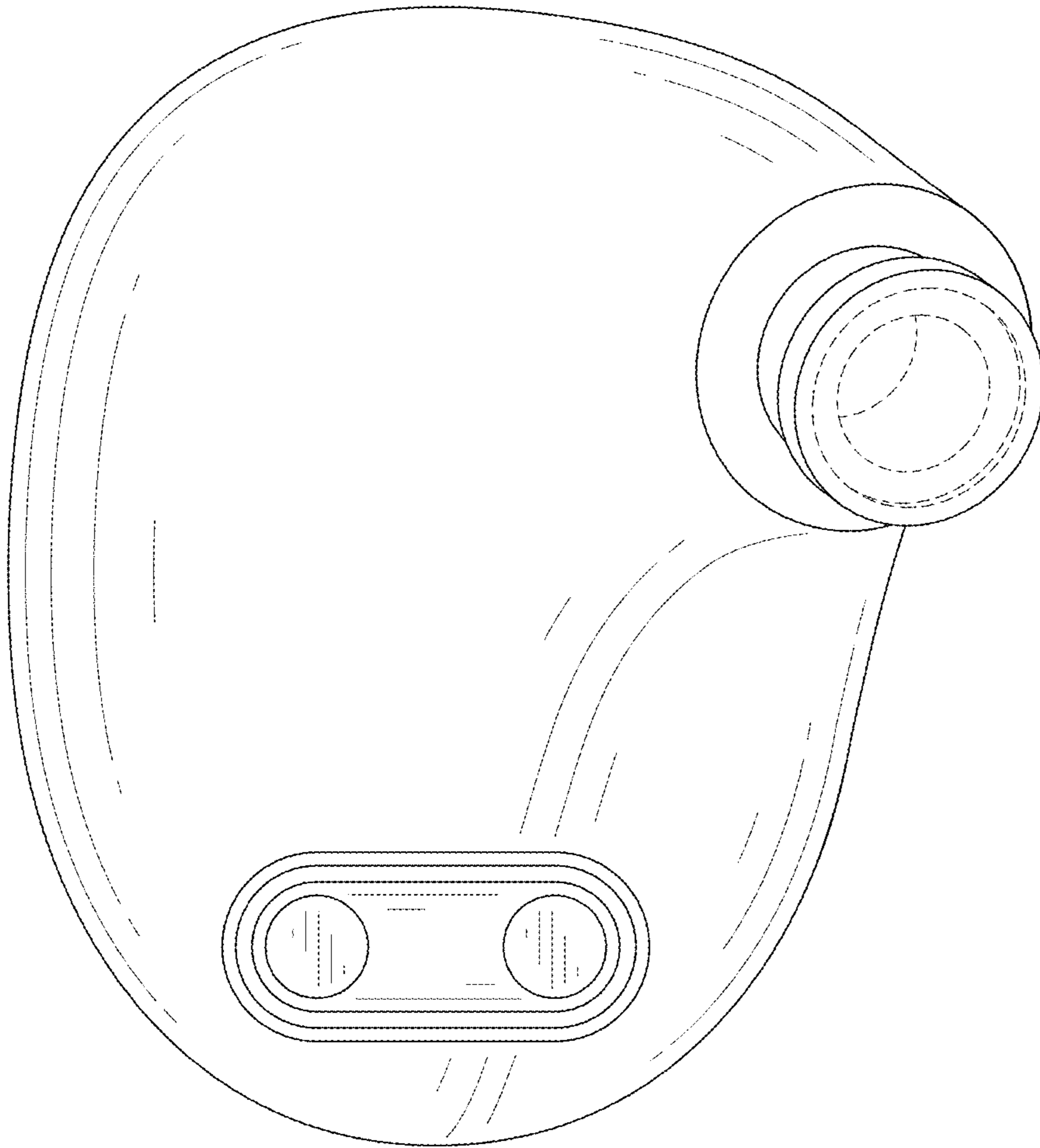

FIG. 53

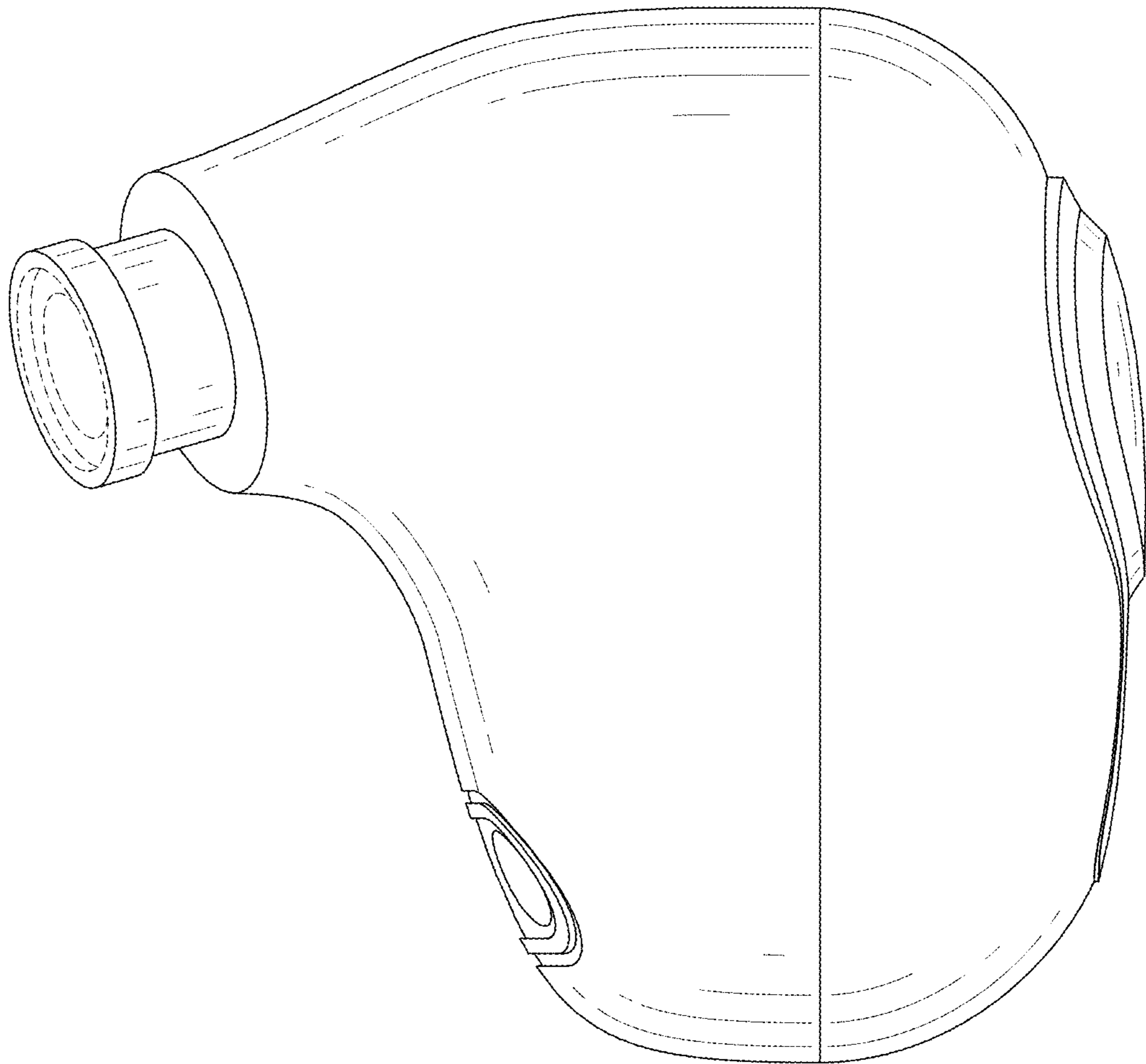

FIG. 54



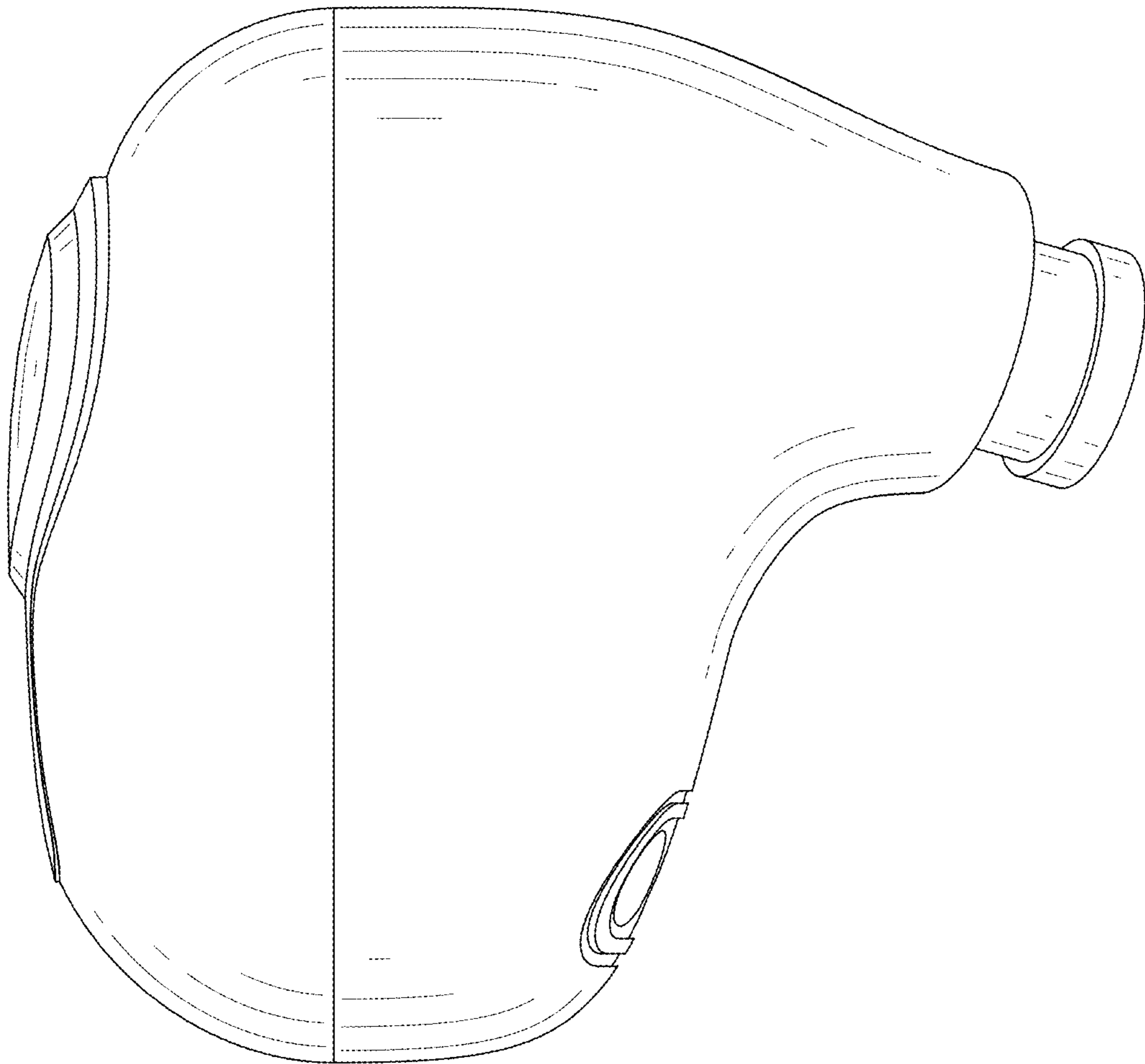

FIG. 55

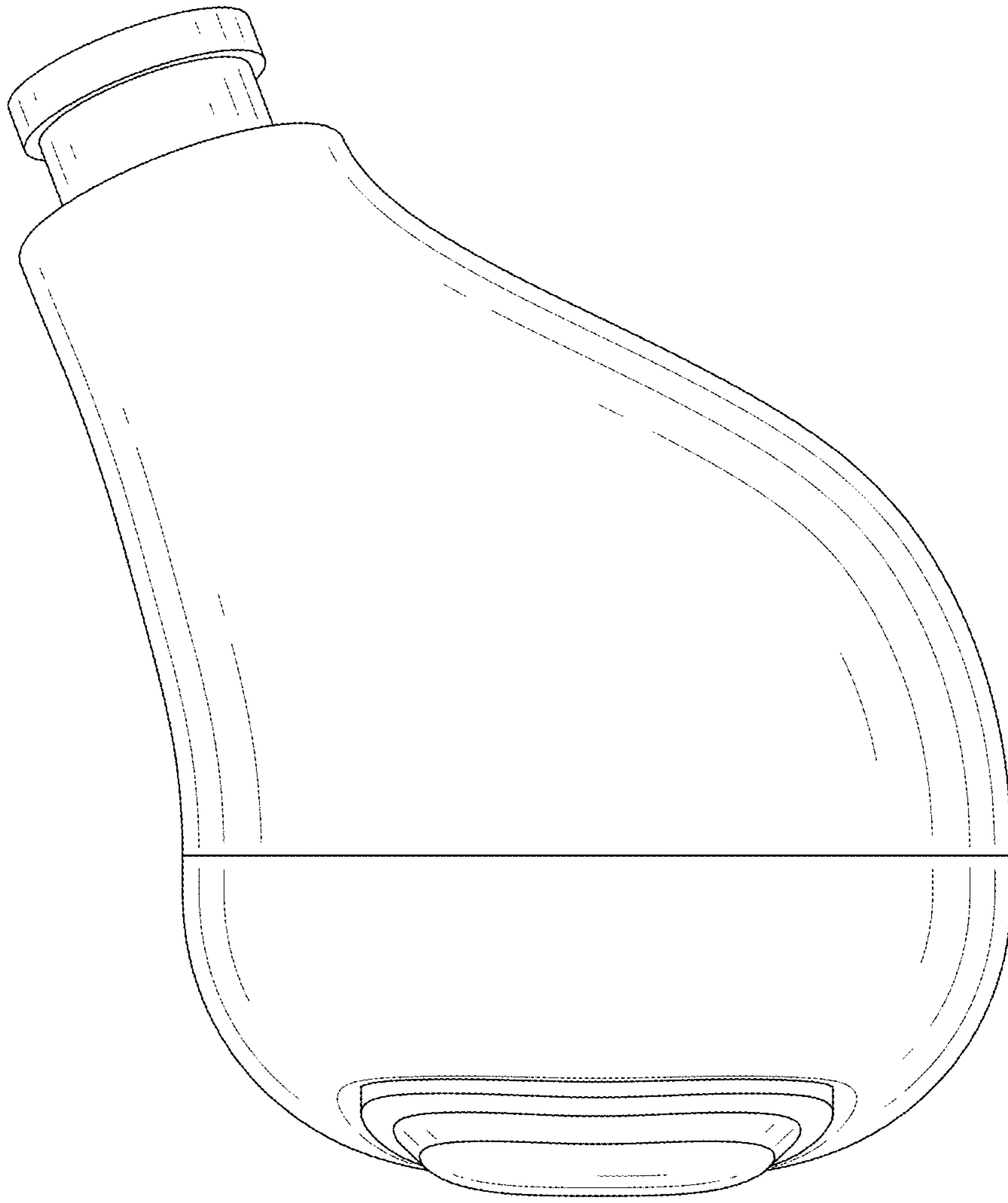

FIG. 56

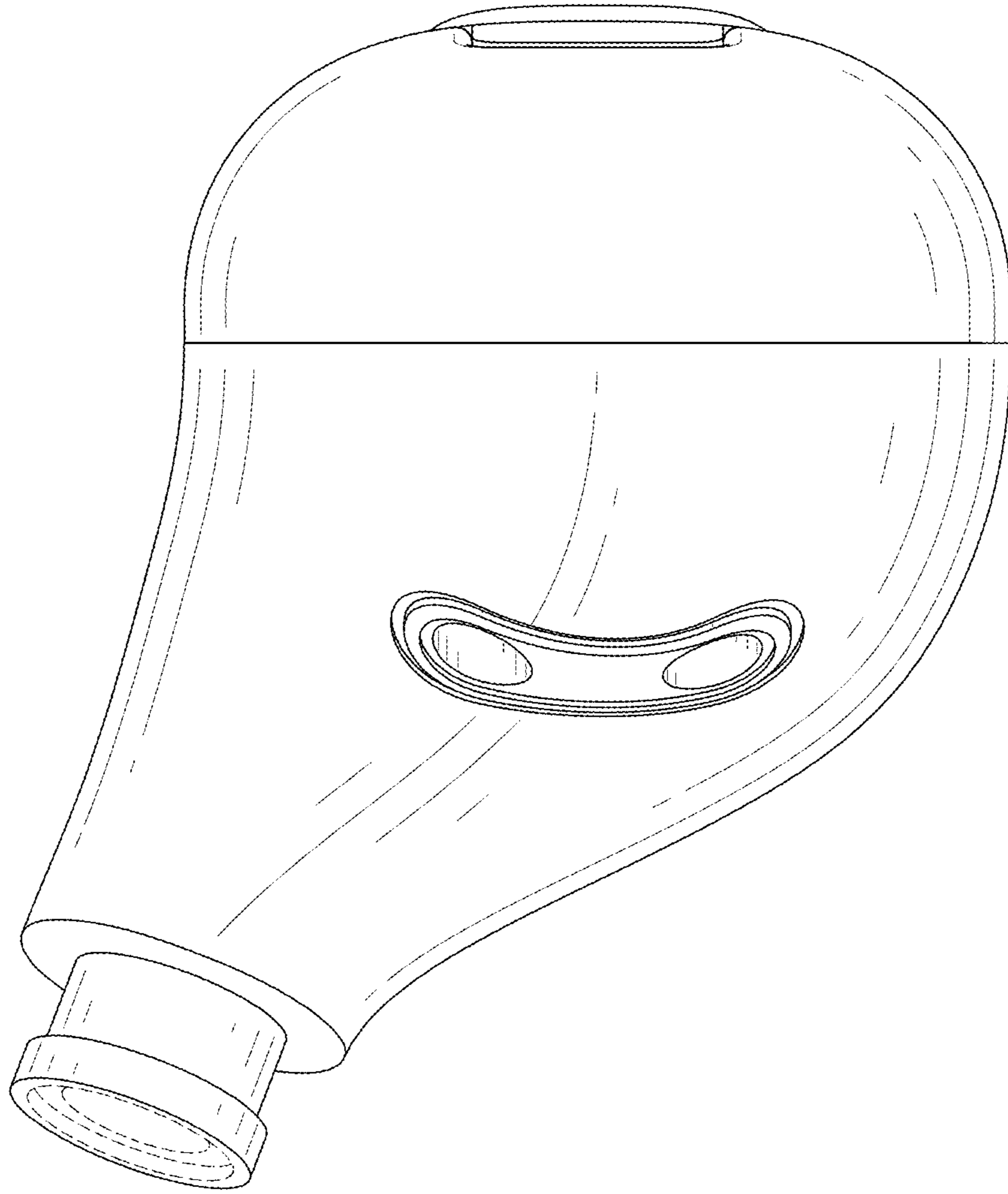

FIG. 57