



US00D902888S

(12) **United States Design Patent**
White

(10) **Patent No.:** **US D902,888 S**

(45) **Date of Patent:** **** Nov. 24, 2020**

(54) **HEADPHONE EARPIECE COVER**

(71) Applicant: **Benjamin White**, Rahway, NJ (US)

(72) Inventor: **Benjamin White**, Rahway, NJ (US)

(**) Term: **15 Years**

(21) Appl. No.: **29/738,342**

(22) Filed: **Jun. 17, 2020**

(51) **LOC (12) Cl.** **14-01**

(52) **U.S. Cl.**
USPC **D14/205**

(58) **Field of Classification Search**
USPC D14/205, 249, 250; 181/129, 130;
D24/174; 128/866, 868; 381/370, 372,
381/376, 378, 379; 2/195.5, 209, 423,
2/174; 455/90.3, 575.1, 569.1; D11/228,
D11/222; D3/18, 28
CPC H04R 1/1066; H04R 1/1016; H04R 5/033;
H04R 5/0335; H04R 1/02; A61F 11/00
See application file for complete search history.

(56) **References Cited**

U.S. PATENT DOCUMENTS

1,878,397	A *	9/1932	Hekler	A45D 44/12 2/174
D142,133	S *	8/1945	Woodruff	D14/249
2,403,418	A *	7/1946	Volkman	H04R 1/1008 181/129
2,447,470	A *	8/1948	Valentine	H04R 1/1008 381/372
2,468,267	A *	4/1949	Mondl	H04R 1/1008 381/376
2,468,721	A *	4/1949	Volkman	H04R 1/1008 181/129
2,561,857	A *	7/1951	Goldman	A61F 11/06 2/172
D171,161	S *	12/1953	Larabell	D14/249
2,669,610	A *	2/1954	Dent	H04R 1/12 379/452

2,727,245	A *	12/1955	Suggs	A61F 11/06 2/174
3,148,249	A *	9/1964	King	H04R 1/12 379/452
3,169,171	A *	2/1965	Wachs	H04R 1/12 379/452
3,192,326	A *	6/1965	Chapman	H04M 1/05 379/447

(Continued)

FOREIGN PATENT DOCUMENTS

EM 001056337-0001 * 12/2008

Primary Examiner — Paula Allen Greene

(57) **CLAIM**

The ornamental design for headphone earpiece cover, as shown and described.

DESCRIPTION

FIG. 1 is an isometric view of the headphone earpiece cover without a headphone, showing my new design;
 FIG. 2 is a side view thereof without the headphone;
 FIG. 3 is a front view thereof without the headphone;
 FIG. 4 is a back view thereof without the headphone;
 FIG. 5 is an isometric view of the headphone earpiece cover about to attach on the headphone;
 FIG. 6 is a isometric view of the headphone earpiece cover attached on the headphone;
 FIG. 7 is an isometric view of the headphone earpiece cover about to attach on the headphone;
 FIG. 8 is an isometric view of the headphone earpiece cover attached on the headphone;
 FIG. 9 is a side view of the headphone earpiece cover about to attach on the headphone; and,
 FIG. 10 is a side view of the headphone earpiece cover attached on the headphone.
 The broken lines in all figure views are directed to environment that illustrates portions of the headphone earpiece cover that forms no part of the claimed design.

1 Claim, 10 Drawing Sheets

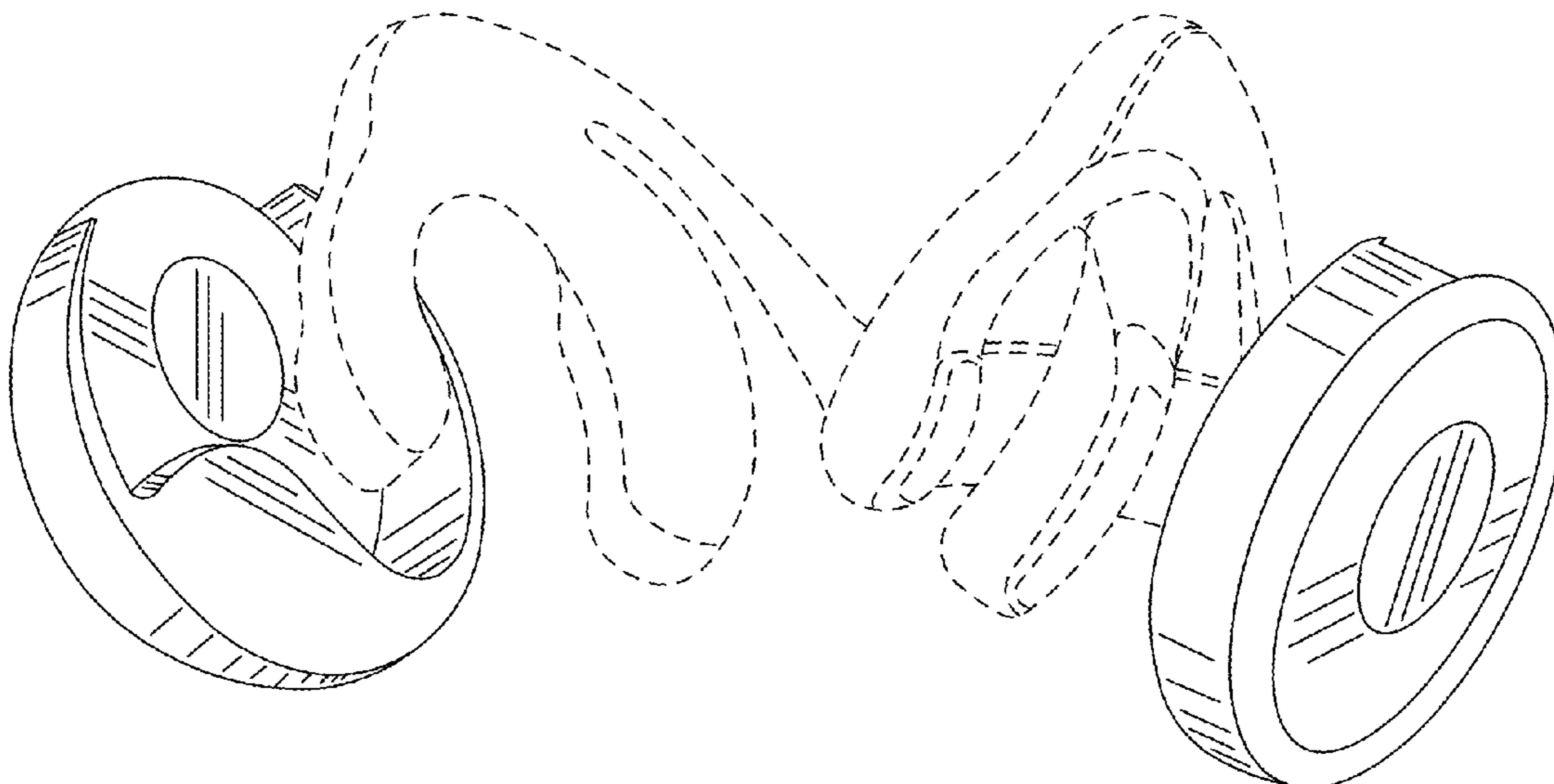

(56)

References Cited

U.S. PATENT DOCUMENTS

3,238,313 A * 3/1966 Kalogris H04R 1/12
379/452
4,385,209 A * 5/1983 Greason H04R 19/016
307/400
4,570,038 A * 2/1986 Tinelli H04R 1/12
379/452
4,669,129 A * 6/1987 Chance H04R 1/1008
181/129
D291,306 S * 8/1987 Espinosa 379/439
4,791,684 A * 12/1988 Schwartz A61F 11/06
2/209
D307,275 S * 4/1990 Pollard 379/452
5,018,599 A * 5/1991 Dohi H04R 1/1008
181/129
5,161,285 A * 11/1992 Jerjian A44B 1/14
24/113 MP
5,621,951 A * 4/1997 Gould A44B 1/14
24/113 MP
D402,412 S * 12/1998 Thorpe D28/82
6,314,185 B1 * 11/2001 Lashley H04M 1/17
379/439
6,392,196 B1 * 5/2002 Lin A61F 11/14
2/209

D464,630 S * 10/2002 Woodworth D13/171
D469,411 S * 1/2003 Decosse D13/171
D475,322 S * 6/2003 Ouellette D11/222
D481,709 S * 11/2003 Solderits D14/223
D512,417 S * 12/2005 Hirakawa D14/223
D519,985 S * 5/2006 Wikel D14/205
D568,290 S * 5/2008 Wikel D14/205
D582,890 S * 12/2008 Koza D14/205
D610,137 S * 2/2010 Horsham D14/250
D657,776 S * 4/2012 Lee D14/205
D671,914 S * 12/2012 Lee D14/205
D677,243 S * 3/2013 Kitayama D14/205
D696,643 S * 12/2013 Lee D14/205
D697,047 S * 1/2014 Yoshida D14/205
D702,209 S 4/2014 Lee
D746,517 S 12/2015 Hayashi
D754,631 S 4/2016 Charles
D776,081 S 1/2017 Willman
D795,835 S * 8/2017 Nagamine D14/205
D809,478 S * 2/2018 Arimoto D14/205
D846,526 S 4/2019 Spencer
D860,972 S * 9/2019 Minarsch D14/223
D884,670 S * 5/2020 White D14/205
D893,449 S * 8/2020 Tsubone D14/205
D897,986 * 10/2020 White D14/205

* cited by examiner

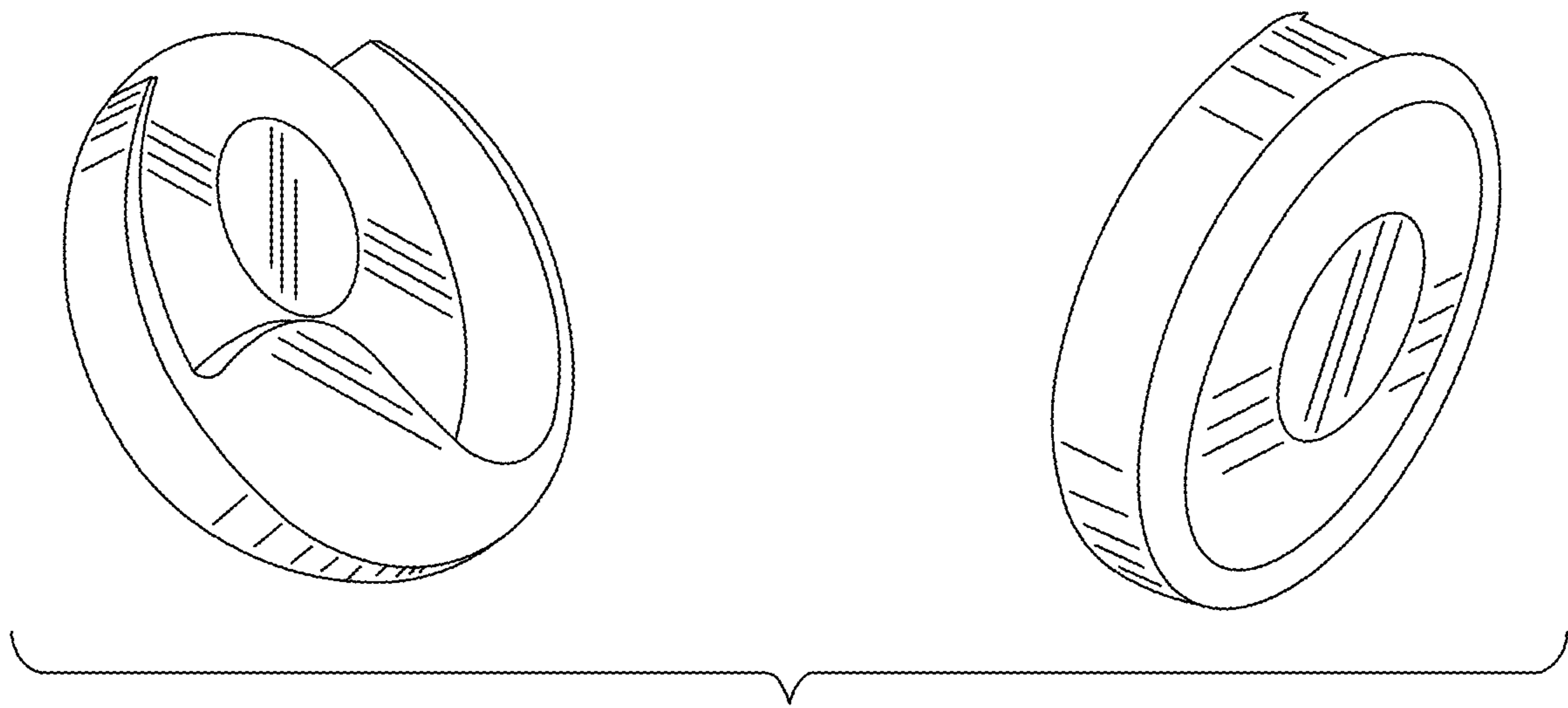

FIG. 1



FIG. 2

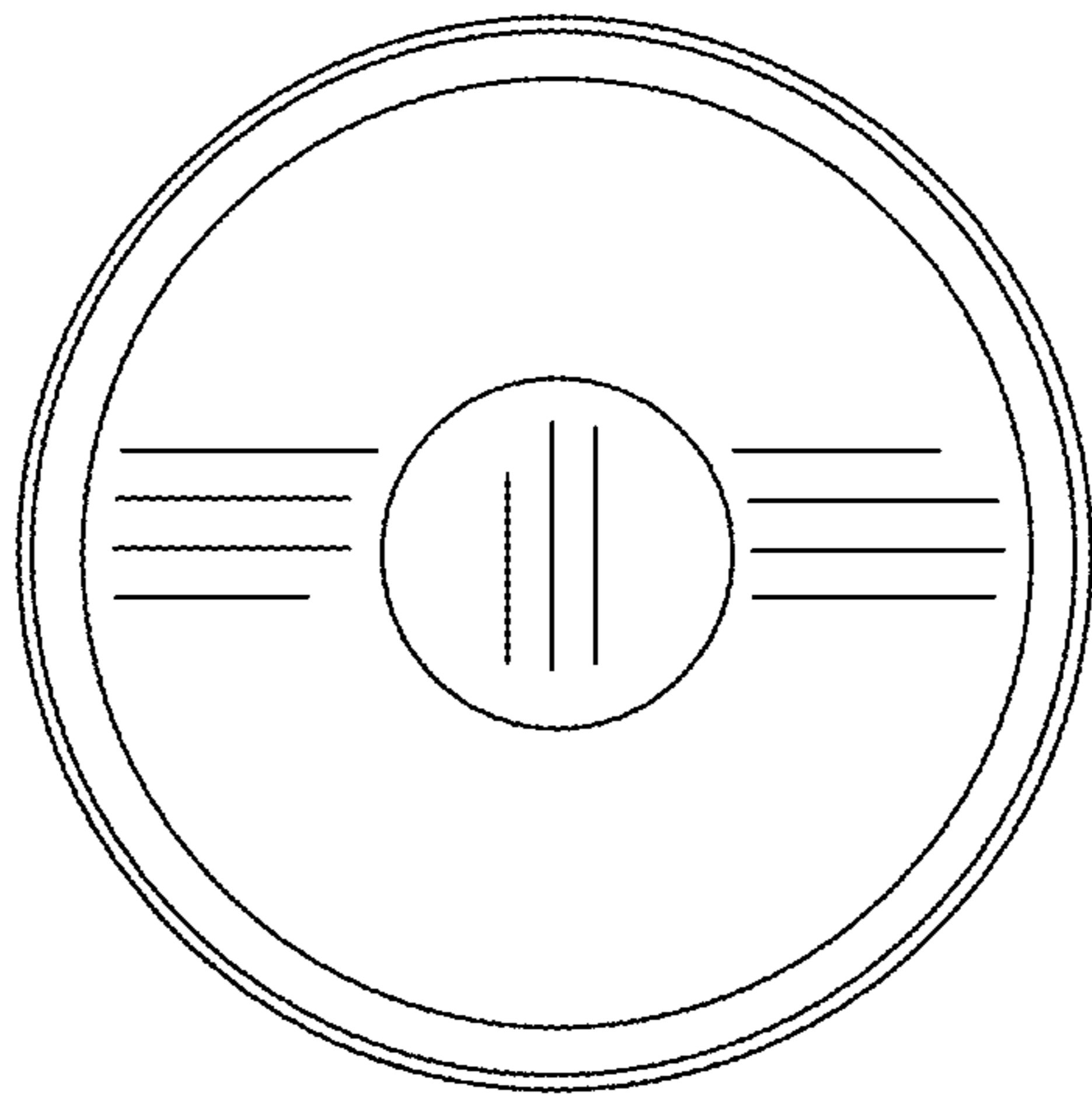

FIG. 3

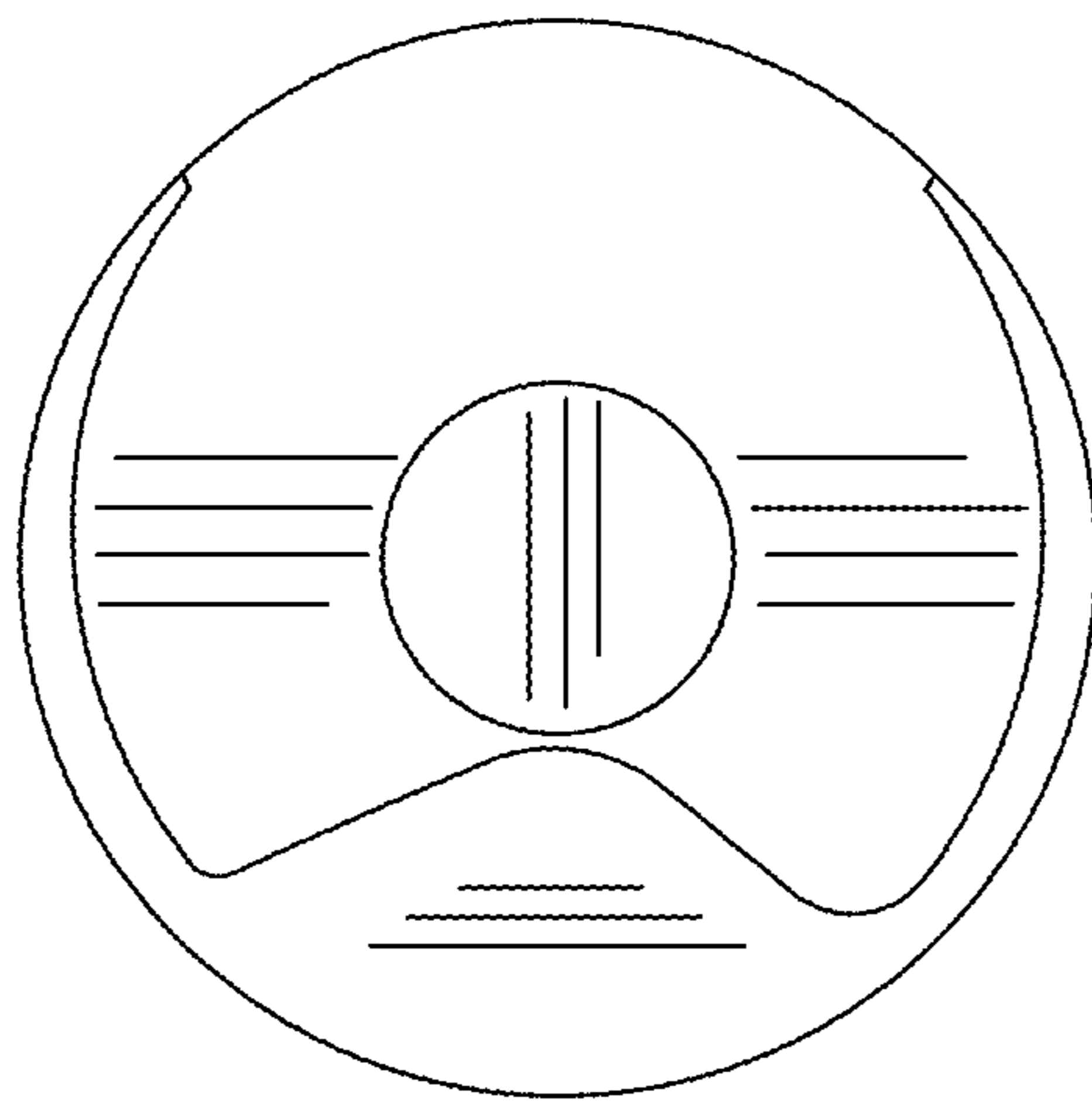

FIG. 4

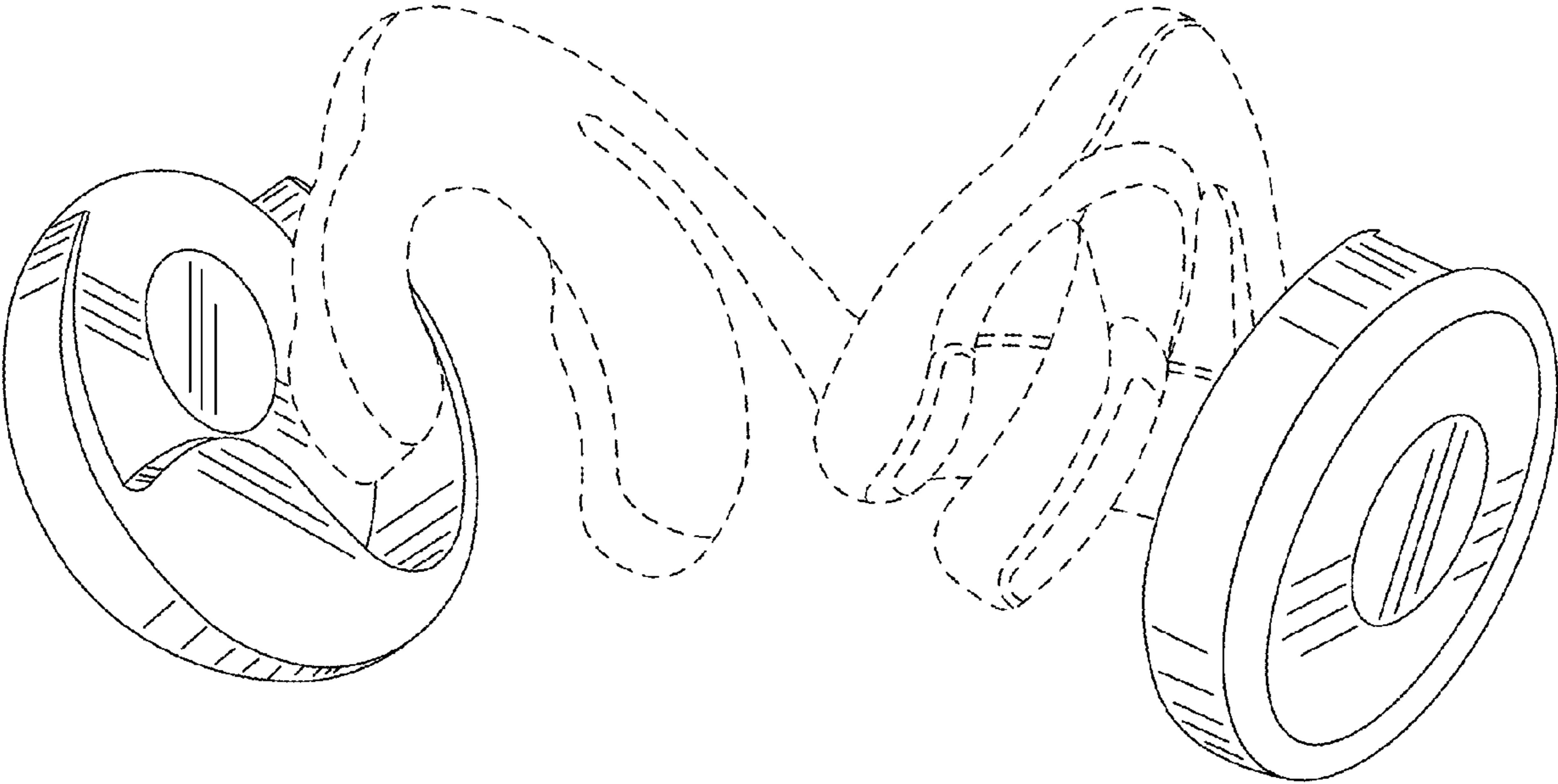

FIG. 5

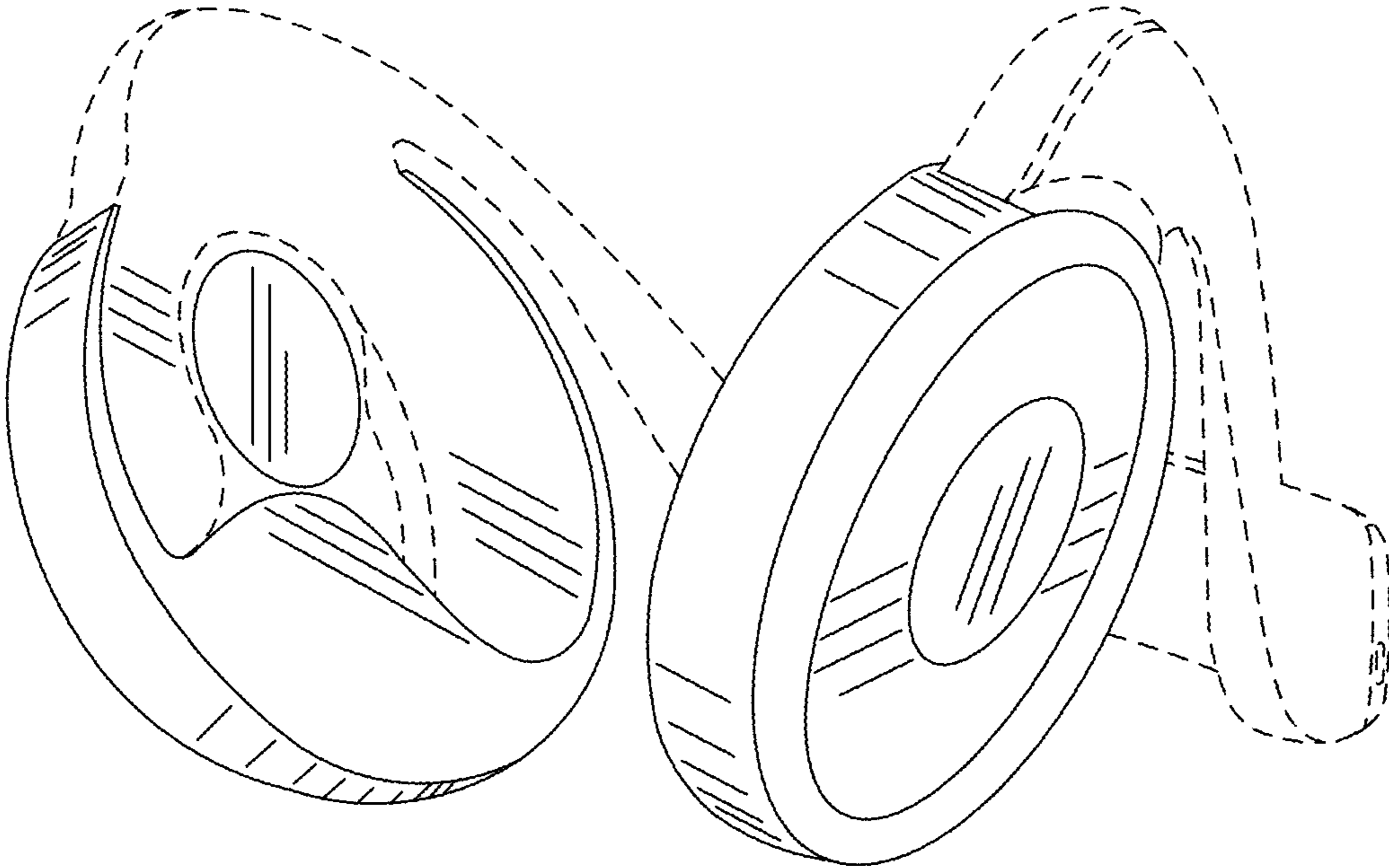

FIG. 6

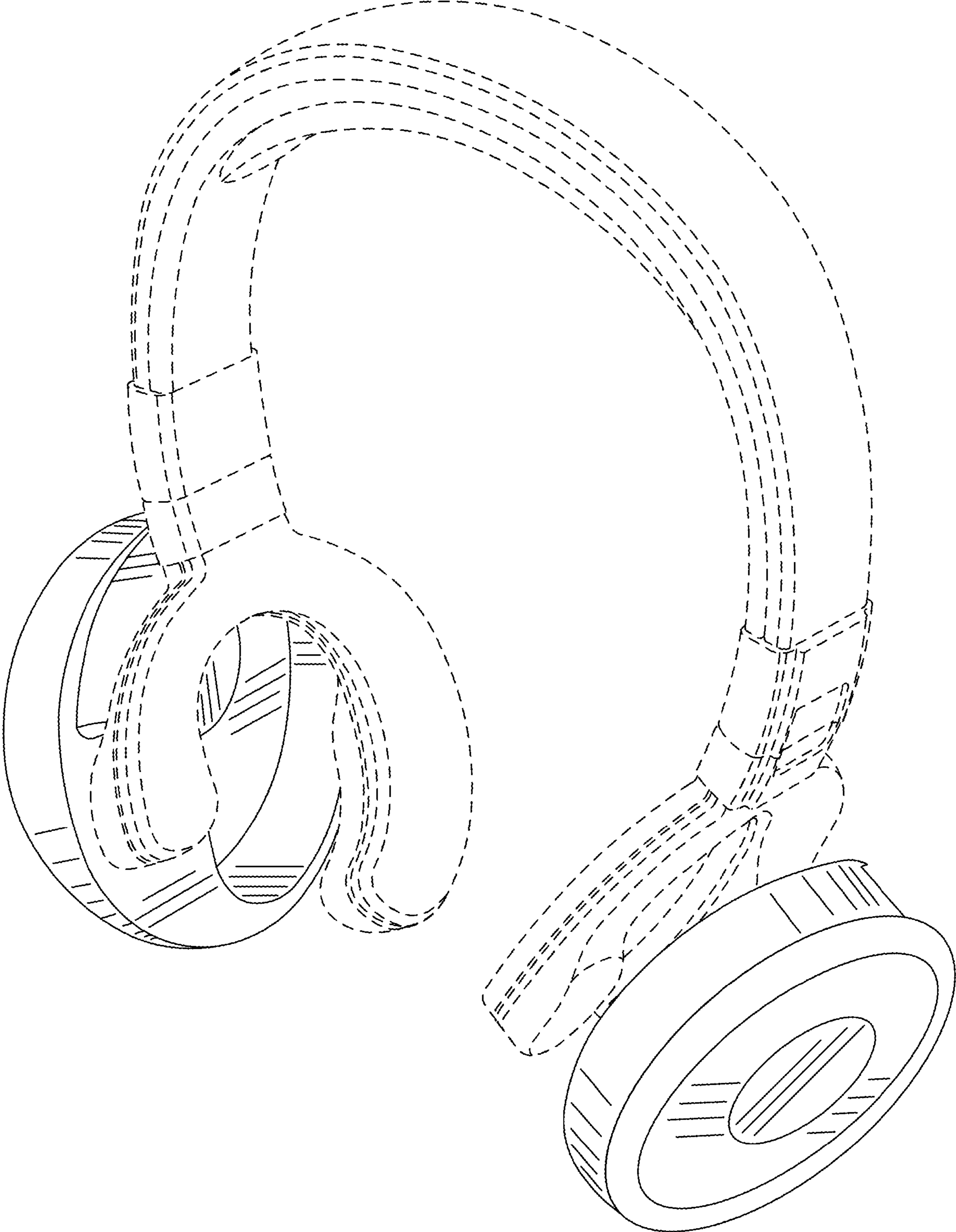

FIG. 7



FIG.8

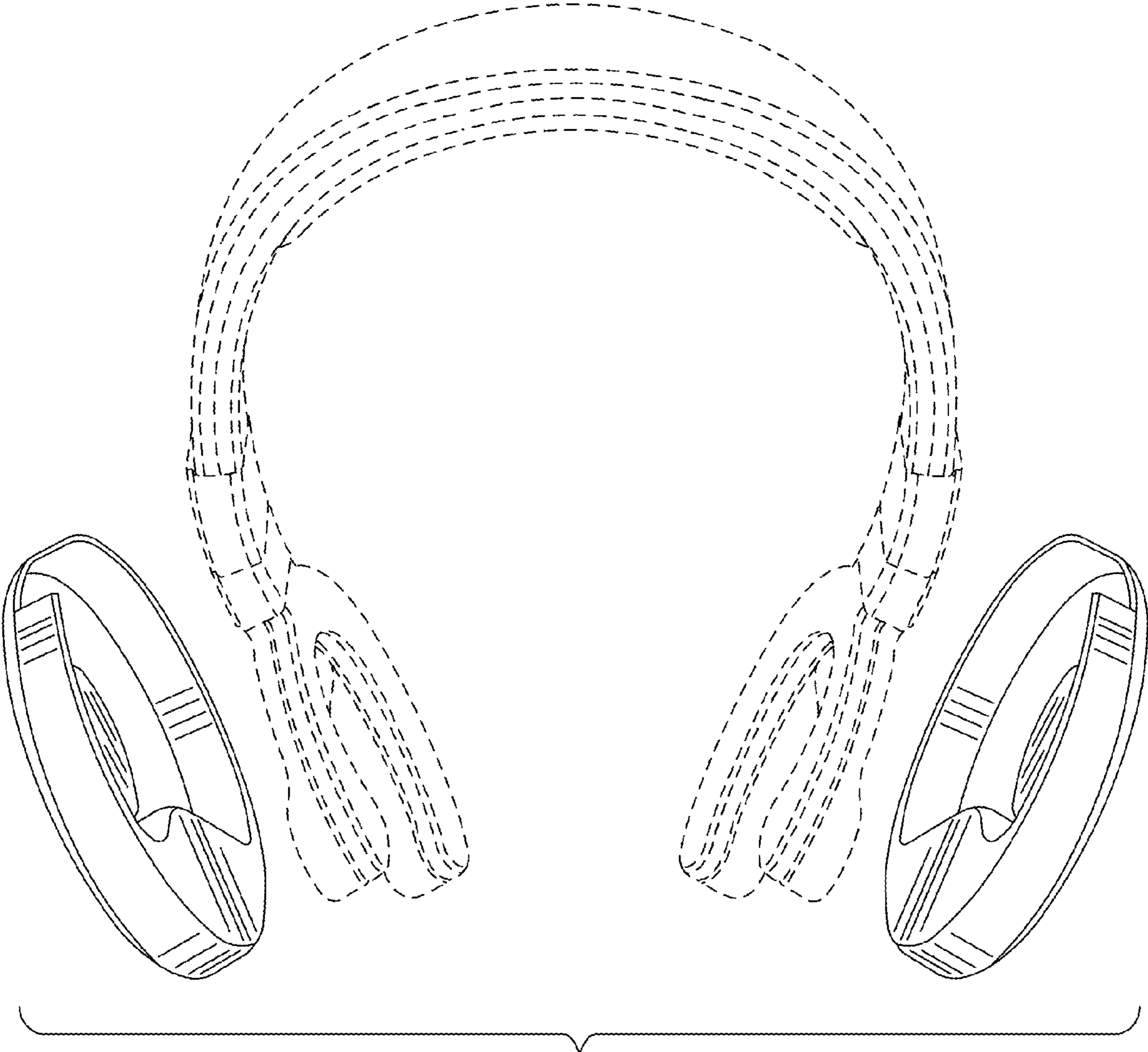

FIG. 9

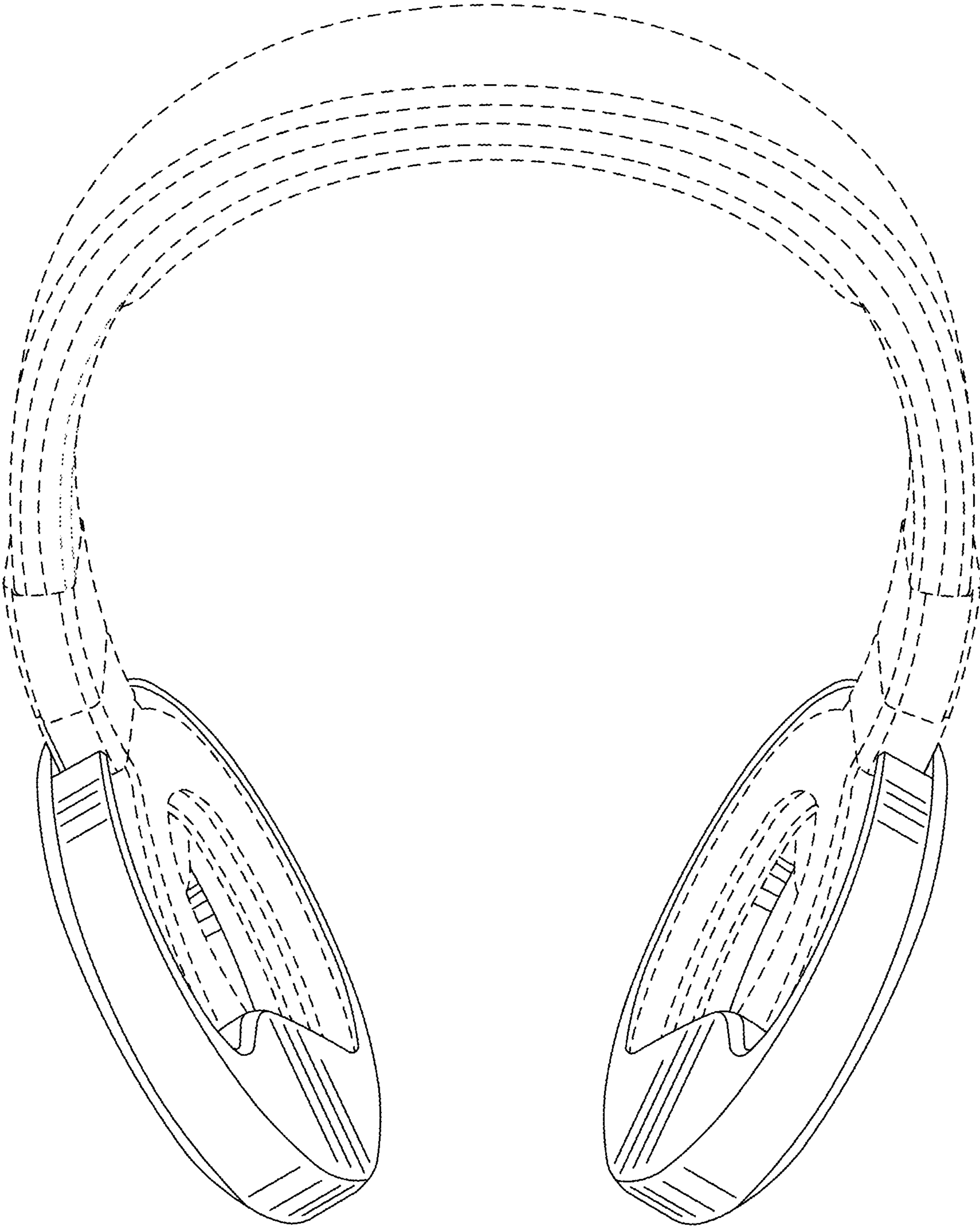

FIG. 10