



US00D902856S

(12) **United States Design Patent** (10) **Patent No.:** **US D902,856 S**
Klein et al. (45) **Date of Patent:** **** Nov. 24, 2020**

(54) **CHARGING UNIT**

(71) Applicant: **SONOVA AG**, Stäfa (CH)
(72) Inventors: **Stefanie Klein**, Lemmer (NL); **Marten Frans Elkerbout**, Dalen (NL)

(**) Term: **15 Years**

(21) Appl. No.: **35/505,603**

(22) Filed: **Jul. 31, 2018**

(80) **Hague Agreement Data**

Int. Filing Date: **Jul. 31, 2018**
Int. Reg. No.: **DM/102559**
Int. Reg. Date: **Jul. 31, 2018**
Int. Reg. Pub. Date: **Sep. 7, 2018**

(51) **LOC (12) Cl.** **13-02**

(52) **U.S. Cl.**
USPC **D13/108**

(58) **Field of Classification Search**
USPC D13/107–110, 118–119, 184; D14/251, D14/253, 432, 434
CPC Y02E 60/12; Y02T 90/14; Y02T 90/122; Y02T 90/128; Y02T 90/163; H02J 7/025; H02J 7/0042; H02J 7/0044; H02J 7/0045; H02J 7/0003; H01F 38/14; H01M 2/1022; H01M 2/1055; H01M 10/44; H01M 10/46; H01M 10/425; B60L 11/182; H01R 13/6675

See application file for complete search history.

(56) **References Cited**

U.S. PATENT DOCUMENTS

D521,927 S * 5/2006 Franck D13/108
D691,372 S * 10/2013 Chun D3/294

D772,572 S * 11/2016 Palmborg D3/201
D789,884 S * 6/2017 Bourgeois D13/107
D790,335 S * 6/2017 Honings D9/424
9,829,953 B2 * 11/2017 Reade H02J 7/0042
D806,648 S * 1/2018 Beedham D13/107
D820,783 S * 6/2018 Gelder D13/107
D821,970 S * 7/2018 Loermann D13/107
D823,246 S * 7/2018 Lin D13/108
D826,152 S * 8/2018 Christiansen D13/108
D843,937 S * 3/2019 Xiao D13/108
2017/0064429 A1 * 3/2017 Hirsch H04R 1/1025

* cited by examiner

Primary Examiner — Nathaniel D. Buckner

(57) **CLAIM**

The ornamental design for a charging unit, as shown and described.

DESCRIPTION

- 1. Charging unit
- 1.1: Perspective
- 1.2: Front
- 1.3: Back
- 1.4: Right
- 1.5: Left
- 1.6: Top
- 1.7: Bottom

Fig. 1 .1 is a top, front and right side perspective view of a hearing aid charging unit showing our new design; fig. 1.2 is a front side view thereof; fig. 1.3 is a rear side view thereof; fig. 1.4 is a right side view thereof; fig. 1.5 is a left side view thereof; fig. 1.6 is a top view thereof; fig. 1.7 is a bottom view thereof.

In the drawings, the broken lines depict portions of the charging unit that form no part of the claimed design.

1 Claim, 7 Drawing Sheets

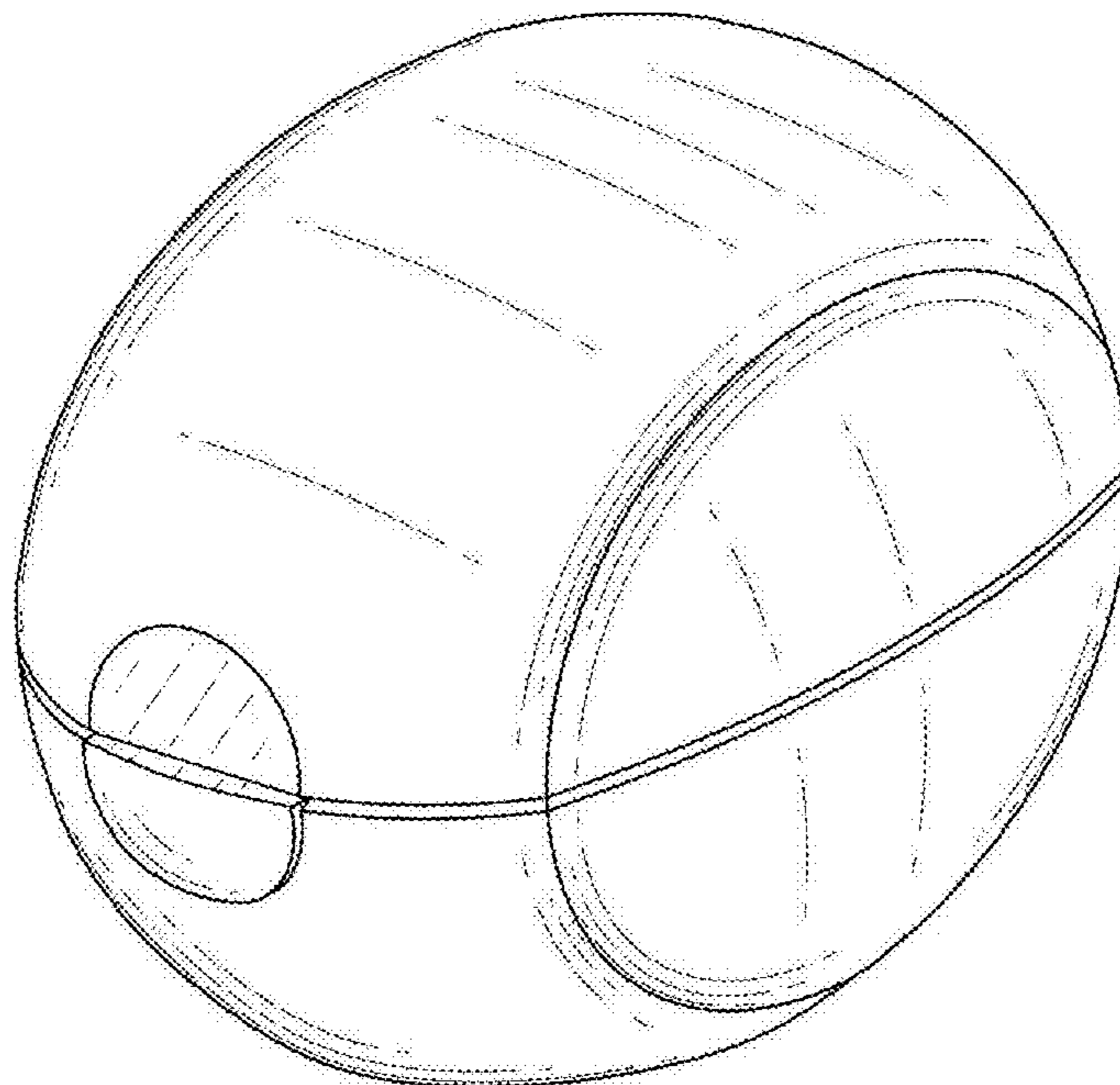

Figure 1.1

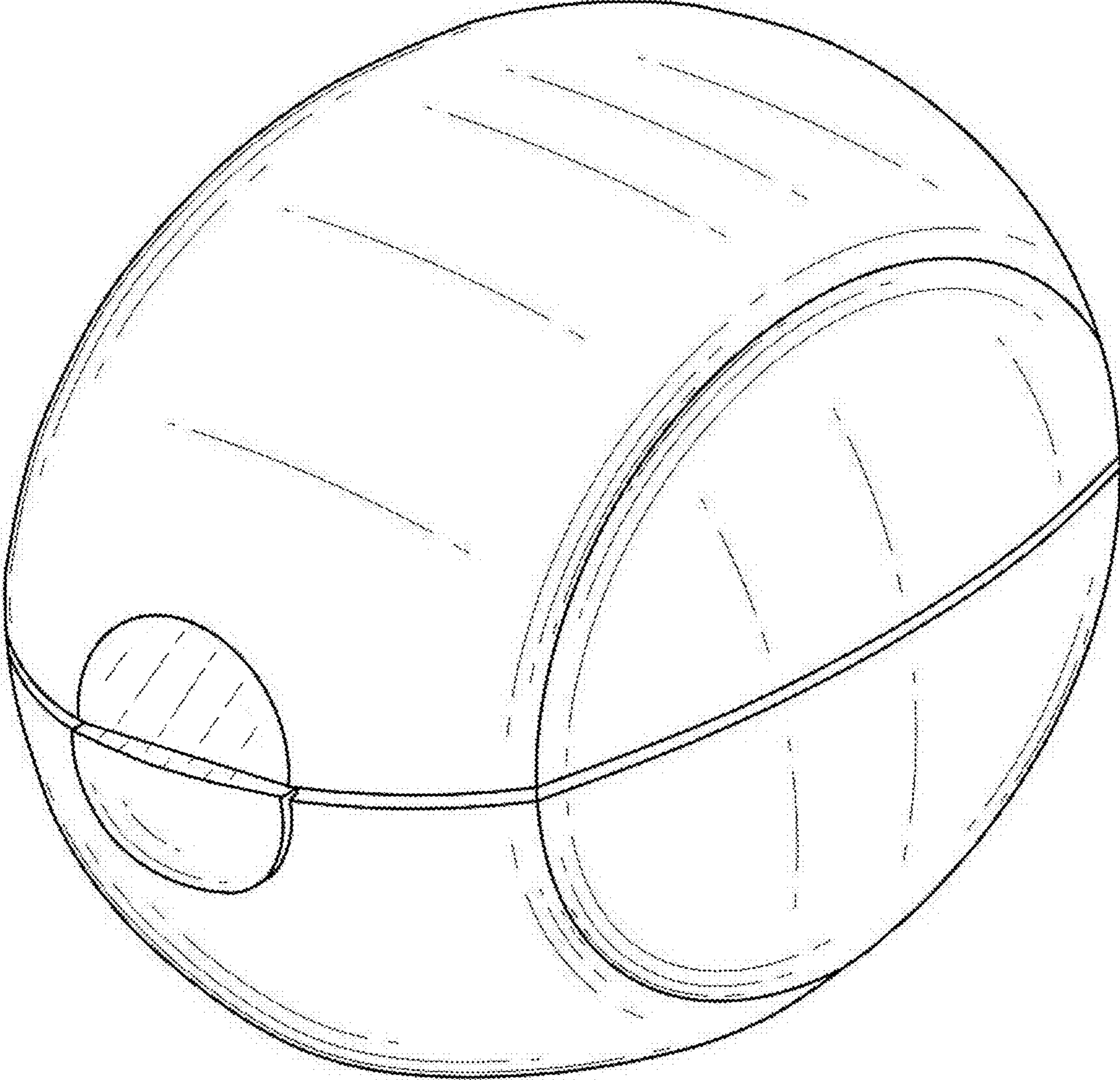

Figure 1.2

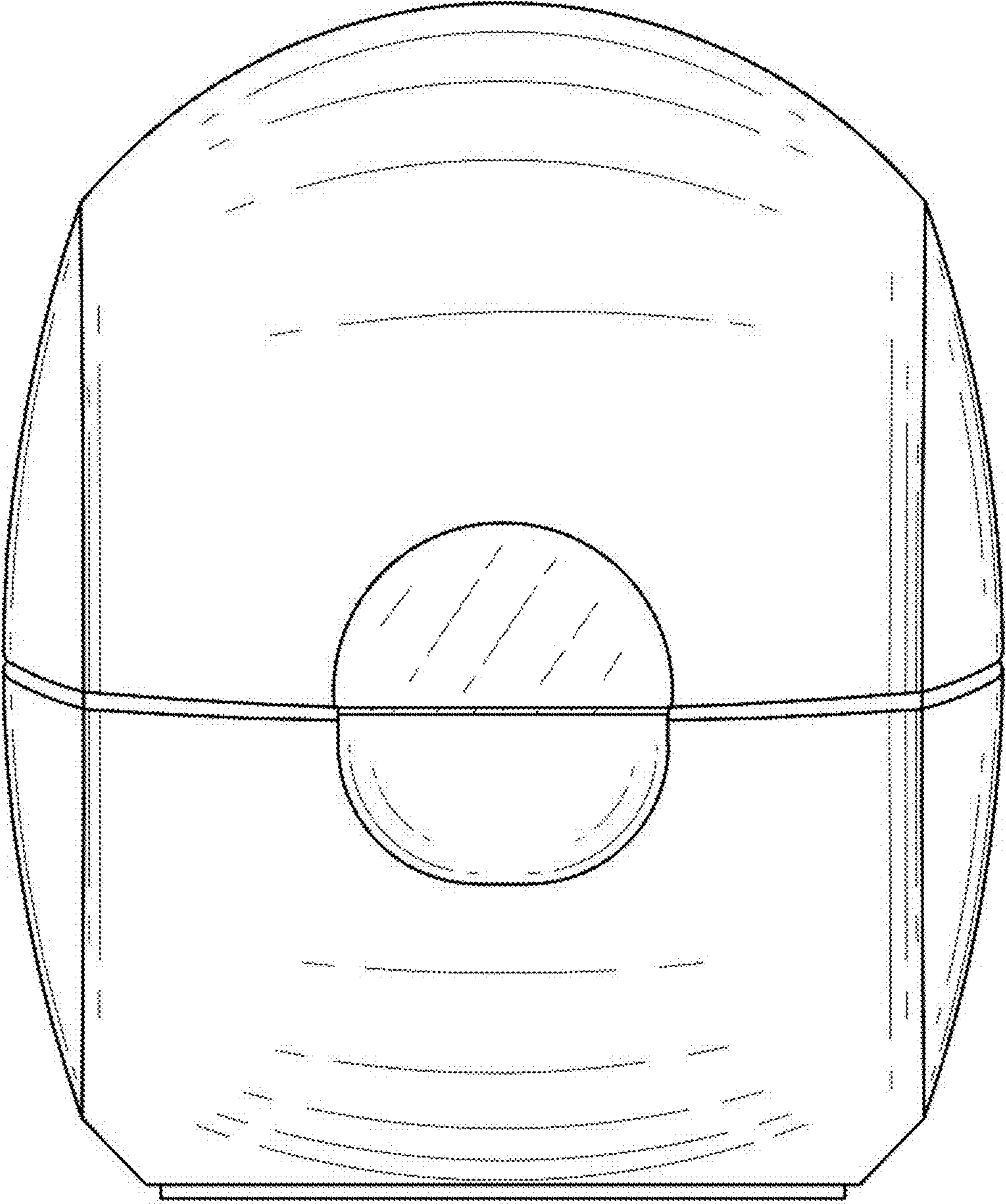
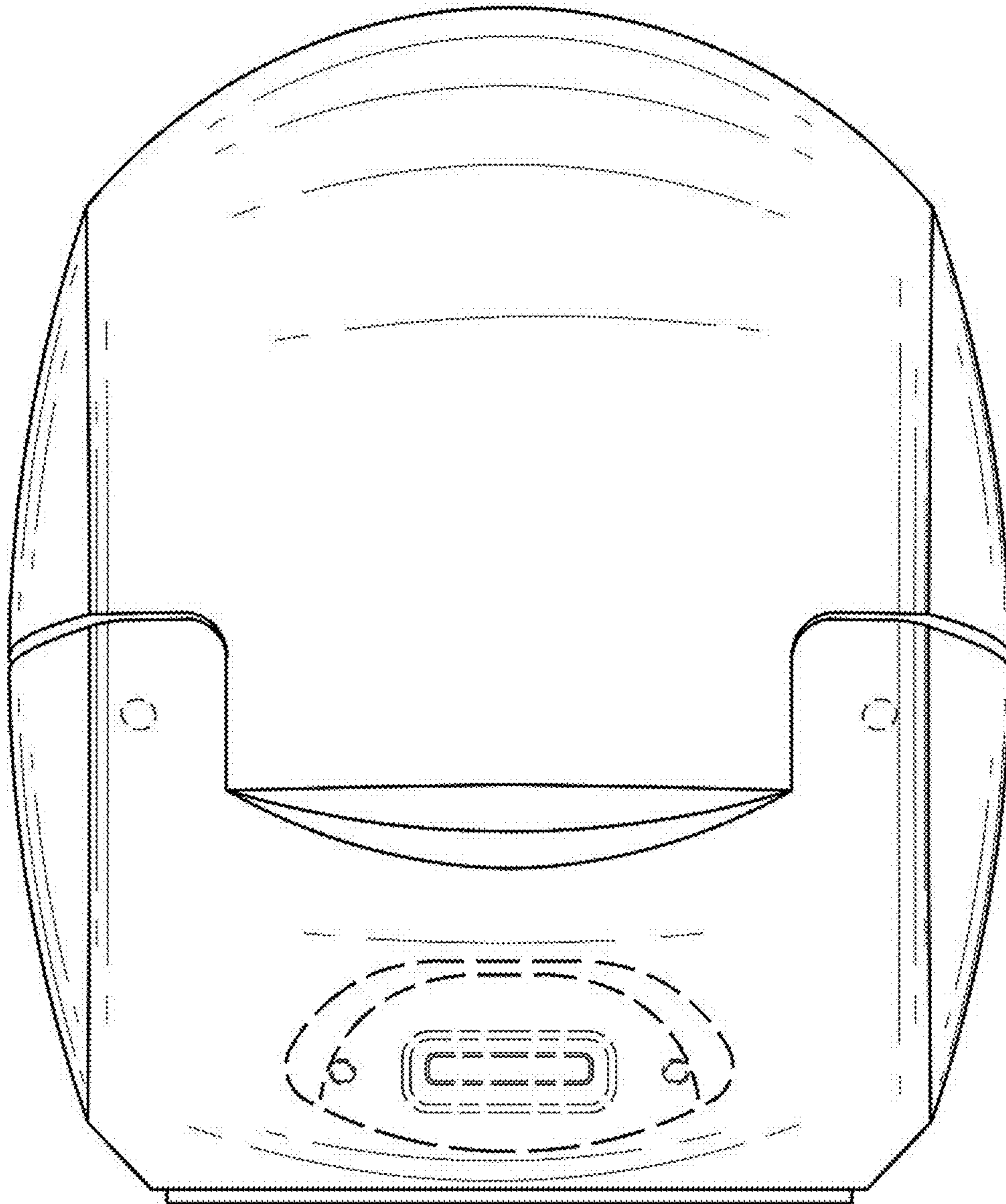
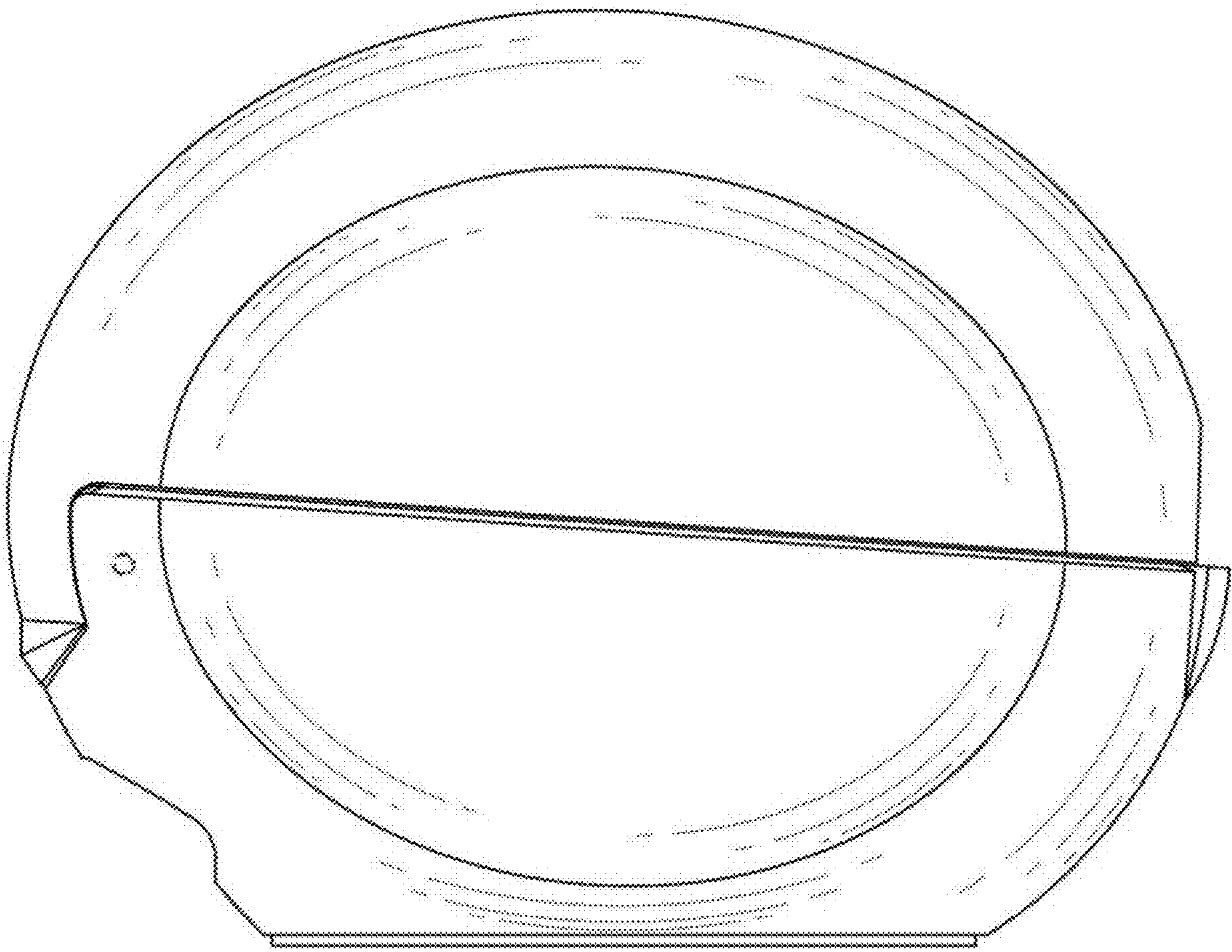

Figure 1.3



1.4



1.5

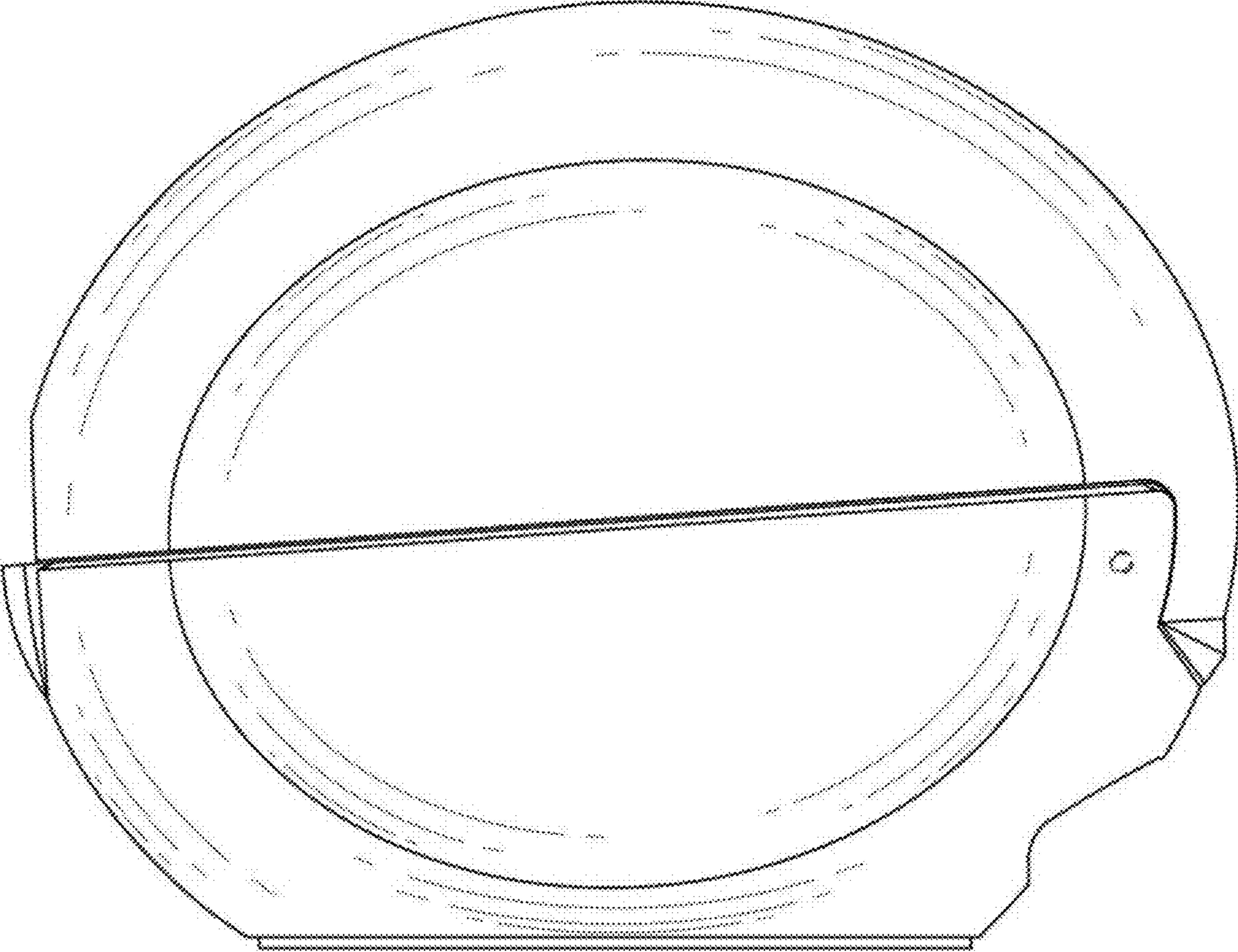

Figure 1.6

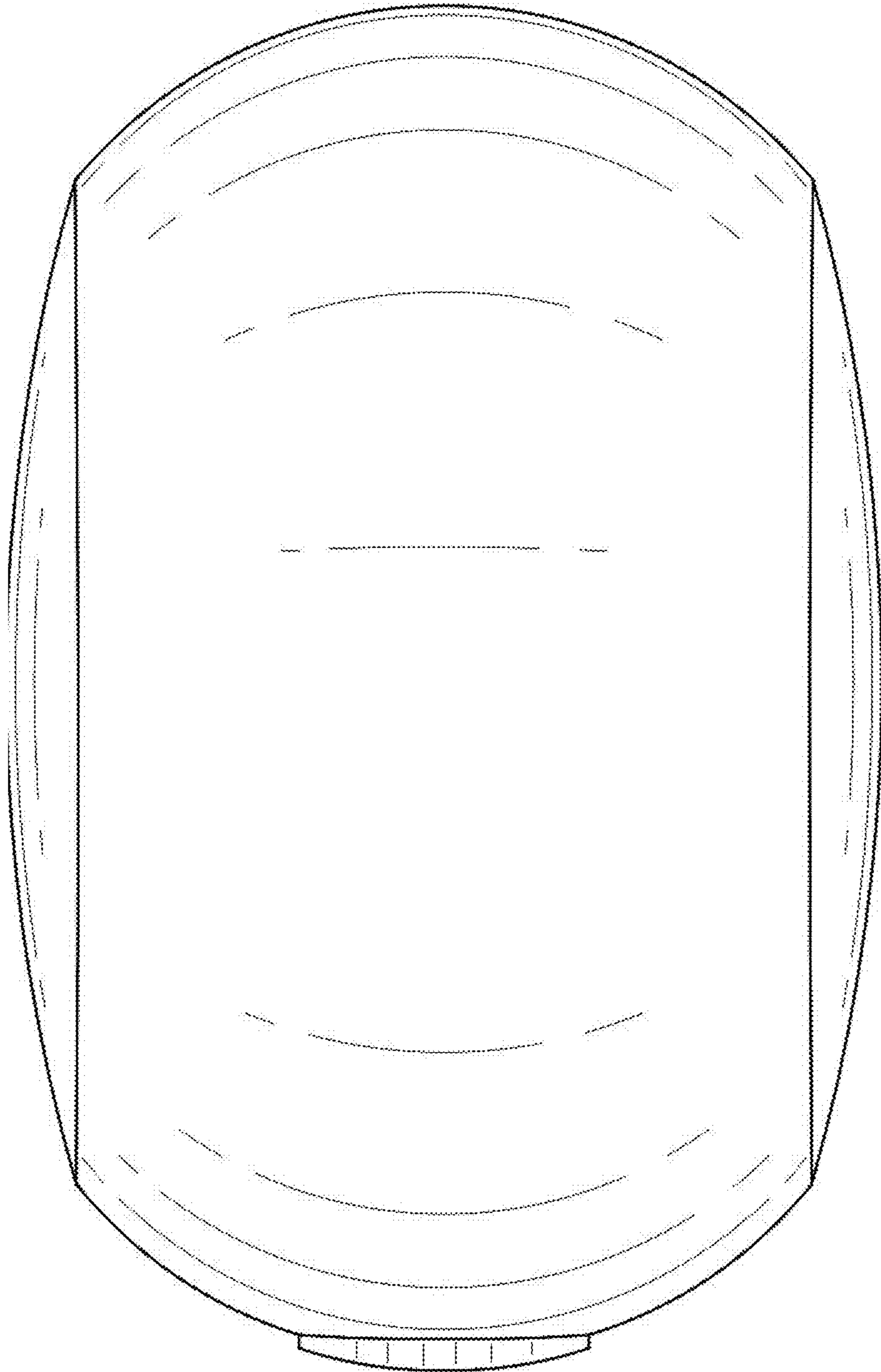

Figure 1.7

