



US00D902798S

(12) **United States Design Patent** (10) **Patent No.:** **US D902,798 S**  
**Hamilton et al.** (45) **Date of Patent:** **\*\* Nov. 24, 2020**

(54) **VEHICLE FRONT LOWER BUMPER COVER**

(71) Applicant: **Ford Global Technologies, LLC**,  
Dearborn, MI (US)

(72) Inventors: **Christopher Hamilton**, Chelmsford  
(GB); **Jordan Bennett**, Brentwood  
(GB); **Simon Collins**, Sevenoaks (GB)

(73) Assignee: **Ford Global Technologies, LLC**,  
Dearborn, MI (US)

(\*\*) Term: **15 Years**

(21) Appl. No.: **29/680,349**

(22) Filed: **Feb. 15, 2019**

(30) **Foreign Application Priority Data**

Aug. 28, 2018 (DE) ..... 40 2018 100 844

(51) **LOC (12) Cl.** ..... **12-16**

(52) **U.S. Cl.**  
USPC ..... **D12/169**

(58) **Field of Classification Search**  
USPC ..... D12/169, 196, 86, 90-92, 163, 190, 98,  
D12/164; 293/102, 113, 115, 117, 120,  
293/193.11; 296/180.1, 180.2; 180/68.1,  
180/68.6  
CPC ..... B60R 19/52; B60K 11/08; B62D 25/08;  
B62B 9/16  
See application file for complete search history.

(56) **References Cited**

**U.S. PATENT DOCUMENTS**

D701,800 S 4/2014 Campbell et al.  
D701,803 S 4/2014 Campbell et al.  
D756,275 S \* 5/2016 Ino ..... D12/169

D786,749 S \* 5/2017 Oohashi ..... D12/169  
D793,921 S \* 8/2017 Takamatsu ..... D12/169  
D800,035 S \* 10/2017 Takamatsu ..... D12/169  
D809,980 S \* 2/2018 Tanaka ..... D12/169  
D824,819 S \* 8/2018 Sukegawa ..... D12/169  
D829,618 S \* 10/2018 Kamahara ..... D12/169  
D830,921 S \* 10/2018 Zhang ..... D12/169  
D841,533 S \* 2/2019 Imai ..... D12/169  
D845,193 S \* 4/2019 Ino ..... D12/169  
D854,983 S \* 7/2019 Katou ..... D12/169  
D856,218 S \* 8/2019 Katou ..... D12/169  
D863,148 S \* 10/2019 Woodhouse ..... D12/169

**FOREIGN PATENT DOCUMENTS**

DE 402012100339.9 5/2012  
DE 402018100303.4 5/2018

\* cited by examiner

*Primary Examiner* — Melody N Brown

(74) *Attorney, Agent, or Firm* — Vichit Chea

(57) **CLAIM**

The ornamental design for a vehicle front lower bumper cover, as shown and described.

**DESCRIPTION**

FIG. 1 is a front elevational view of a vehicle front lower bumper cover, showing our new design;  
FIG. 2 is a rear elevational view thereof;  
FIG. 3 is a left side elevational view thereof;  
FIG. 4 is a right side elevational view thereof;  
FIG. 5 is a top plan view thereof;  
FIG. 6 is a bottom plan view thereof;  
FIG. 7 is a top, front, and left side perspective view thereof;  
and,  
FIG. 8 is a bottom, front, and left side perspective view thereof.

**1 Claim, 8 Drawing Sheets**

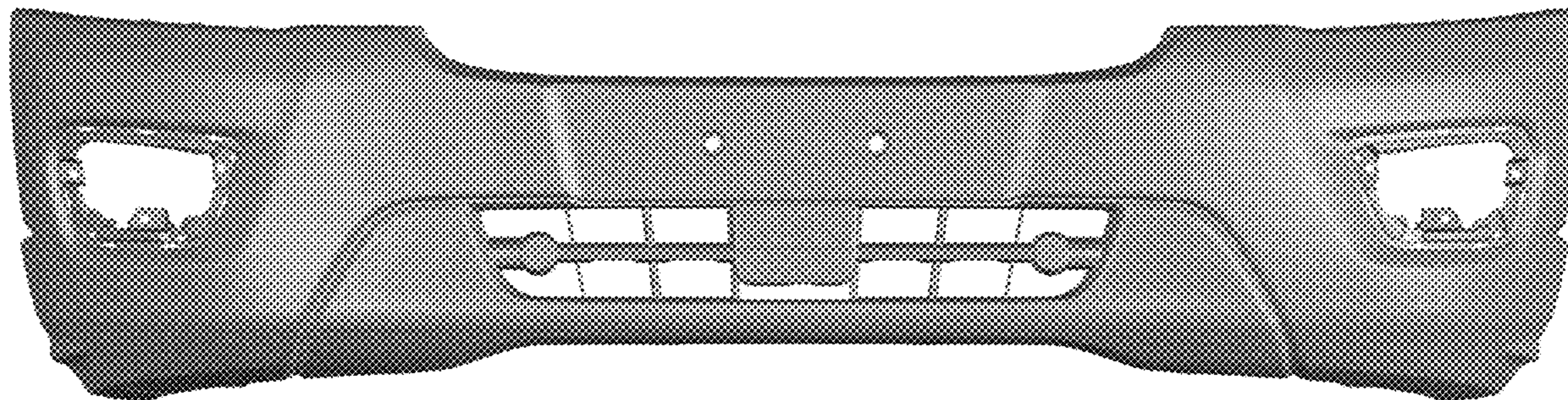



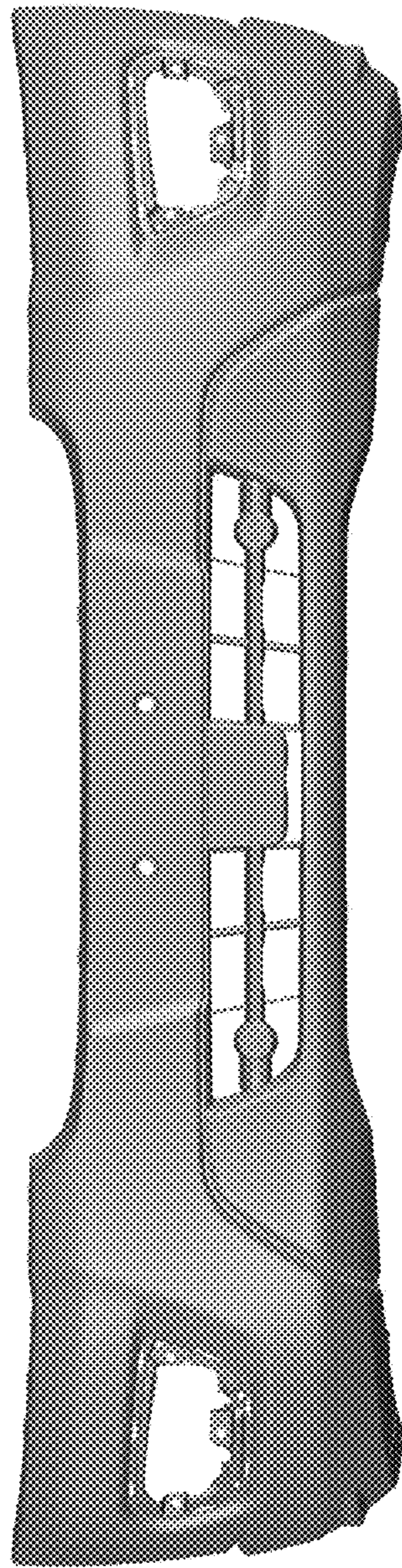

Fig. 1

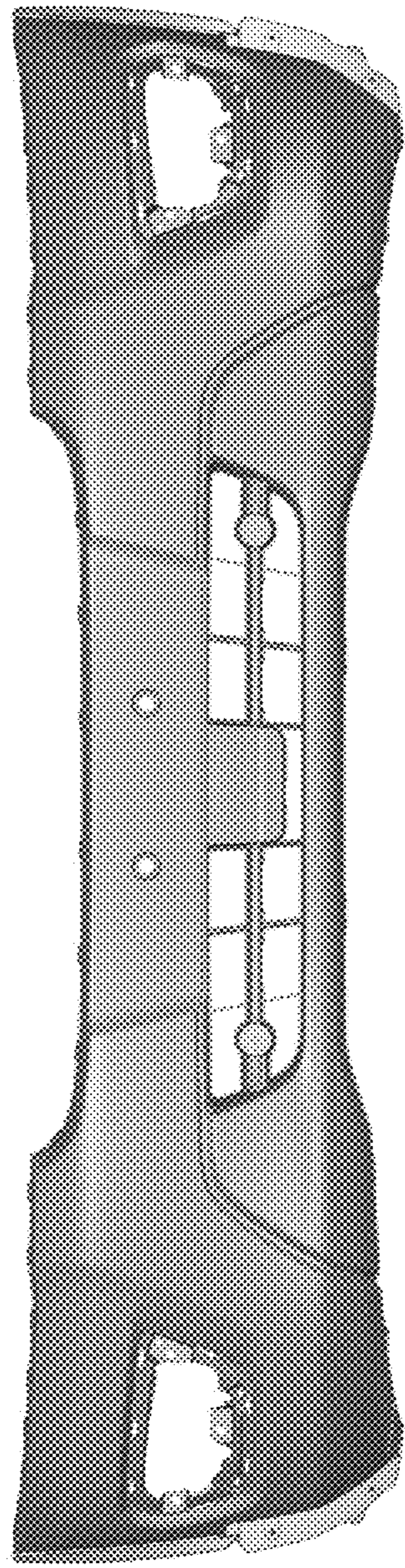

Fig. 2

Fig. 3

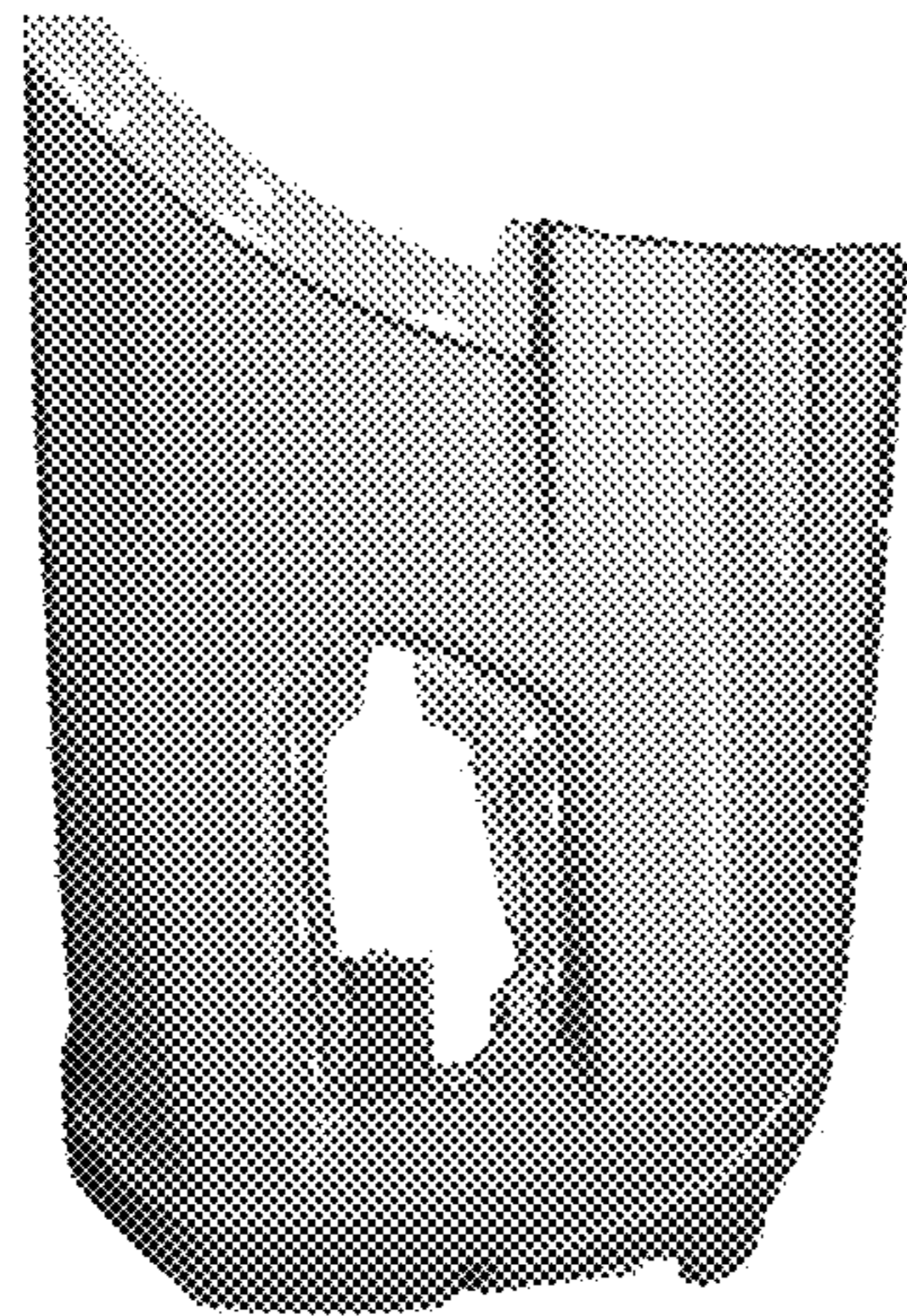
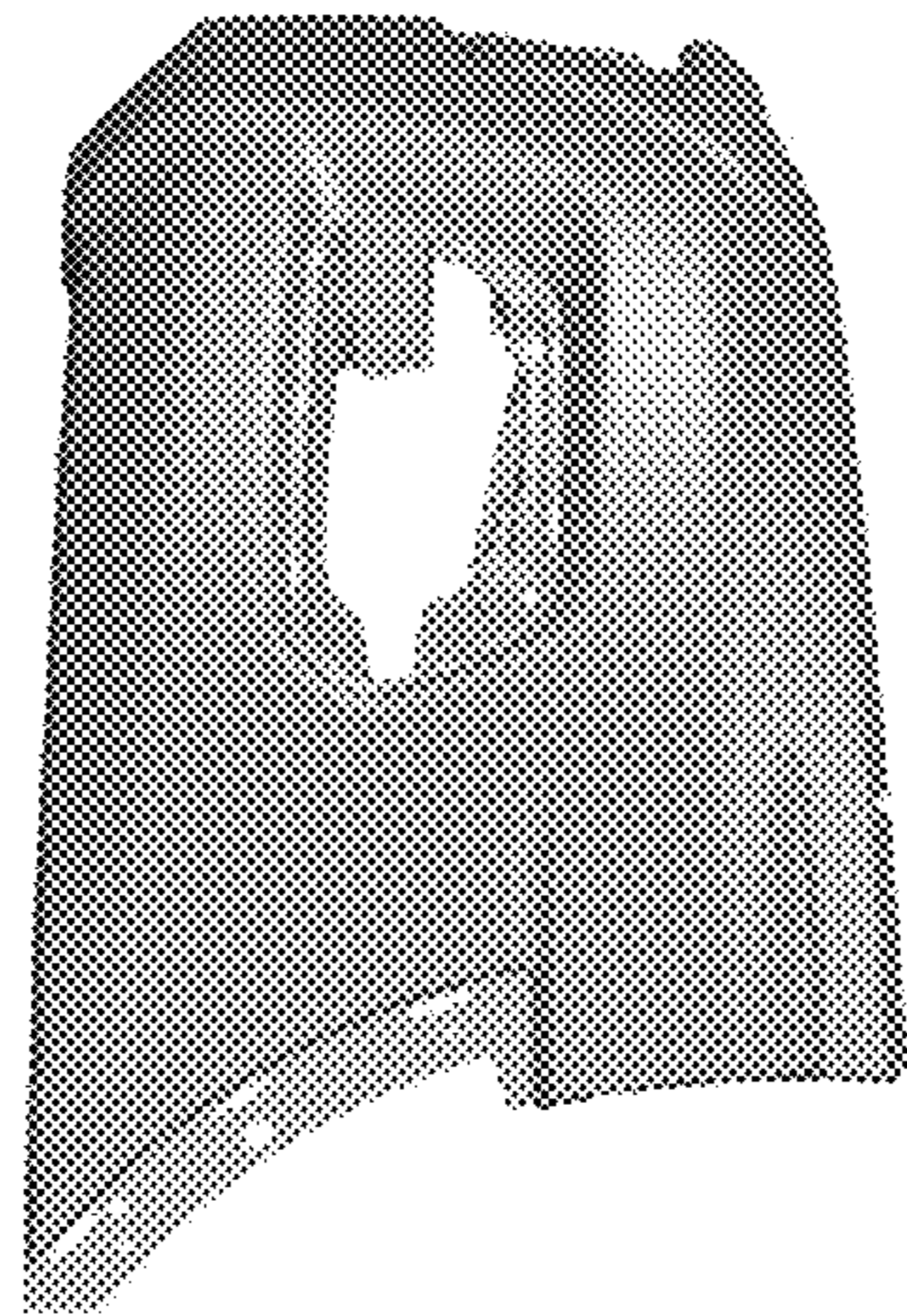



Fig. 4



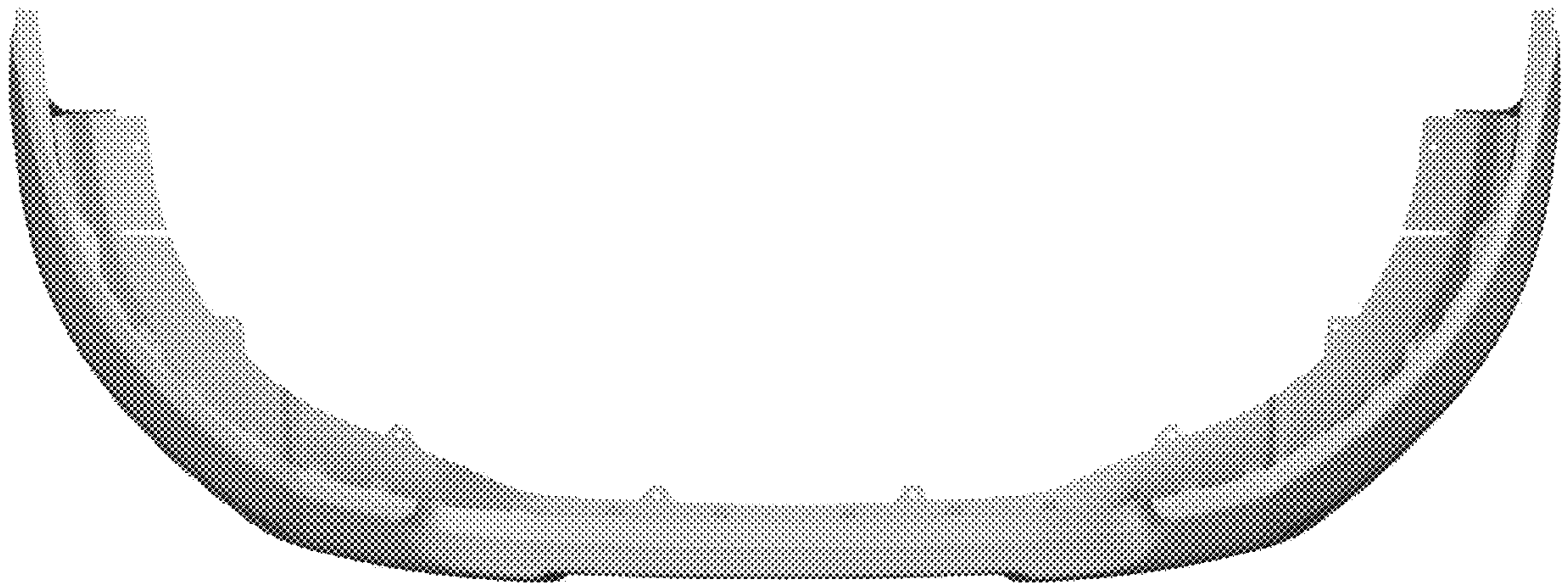

Fig. 5

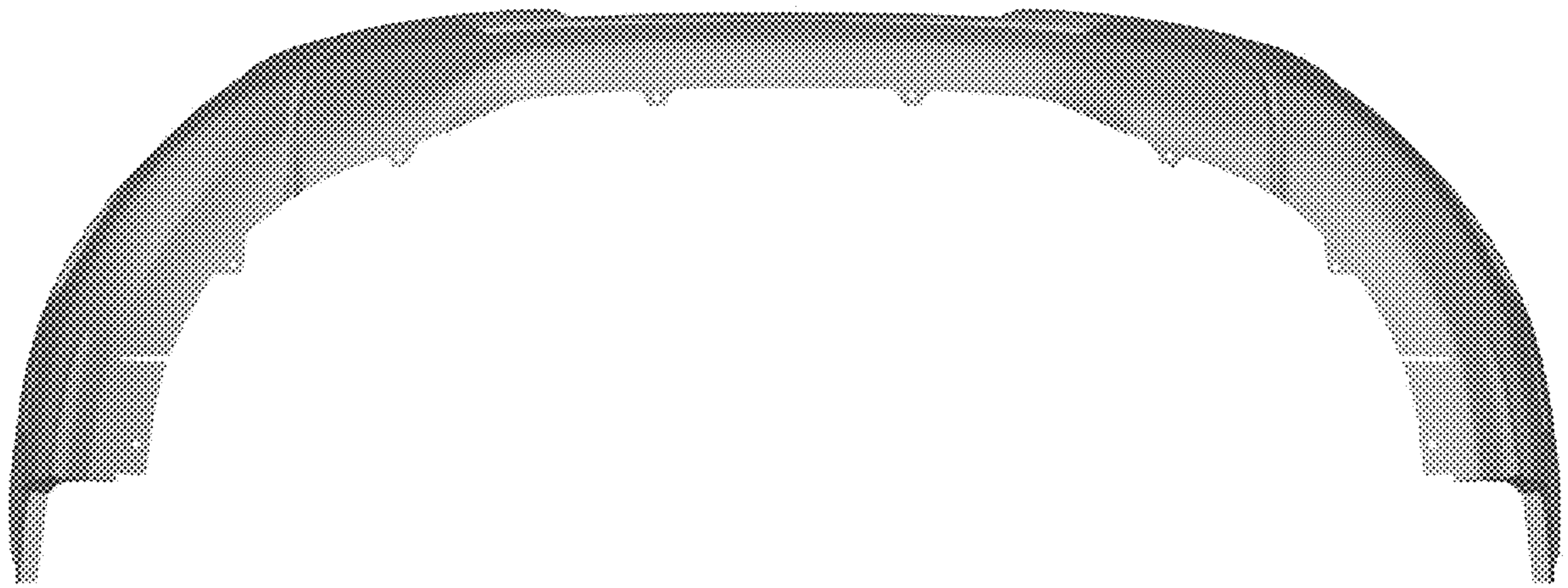

Fig. 6



Fig. 7





Fig. 8