



US00D902732S

(12) **United States Design Patent**
Repetti

(10) **Patent No.:** **US D902,732 S**

(45) **Date of Patent:** **** Nov. 24, 2020**

(54) **BOTTLE**

(71) Applicant: **Sanpellegrino S.p.A.**, Località Ruspino (IT)

(72) Inventor: **Daniele Repetti**, Località Ruspino (IT)

(73) Assignee: **Sanpellegrino S.p.A.**, Ruspino (IT)

(**) Term: **15 Years**

(21) Appl. No.: **29/677,671**

(22) Filed: **Jan. 23, 2019**

(51) **LOC (12) Cl.** **09-01**

(52) **U.S. Cl.**
USPC **D9/553; D9/555; D9/558**

(58) **Field of Classification Search**

USPC D9/553, 530, 539, 540, 523, 560, 563,
D9/549, 738, 500, 501, 428, 429, 565,
D9/575, 529, 531; D7/509, 510, 511,
D7/523, 605, 608, 603; D24/121;
D11/143

CPC B65D 1/0223; B65D 79/005; B65D
2501/0081; B65D 23/102; B65D
2501/0036

See application file for complete search history.

(56) **References Cited**

U.S. PATENT DOCUMENTS

D94,574 S *	2/1935	Steelman	D9/545
D111,411 S *	9/1938	D'Addario	D9/550
D411,740 S *	6/1999	Kim	D9/553
D432,919 S *	10/2000	Spring	D9/538
D434,662 S *	12/2000	Colonna	D9/500
D643,736 S *	8/2011	Lagerqvist	D9/550
D653,118 S *	1/2012	Asano	D9/553
D674,289 S *	1/2013	Parodi	D9/651
D695,614 S *	12/2013	Crowe	D9/500
D714,654 S *	10/2014	Faillant Dumas	D9/682
D717,171 S *	11/2014	Delacourt	D9/516
D763,694 S *	8/2016	Herman	D9/500

D765,511 S *	9/2016	George	D9/503
D805,394 S *	12/2017	Riboli	D9/555
D815,946 S *	4/2018	Thompson	D9/500
D826,051 S *	8/2018	Lauret	D9/500
D833,826 S *	11/2018	Sanchez Garcia	D7/523

(Continued)

FOREIGN PATENT DOCUMENTS

WO D200773-001 * 5/2019

OTHER PUBLICATIONS

S.Pellegrino Celebrates Its 120th Anniversary (YouTube), available Feb. 27, 2019, [online], [site visited Jul. 10, 2020]. Video available from internet, URL: https://www.youtube.com/watch?v=-tFKXYC3EEA&feature=emb_logo (Year: 2019).*

(Continued)

Primary Examiner — W. A. Teddy Falloway

Assistant Examiner — Rani J Abdallah

(74) *Attorney, Agent, or Firm* — Finnegan, Henderson, Farabow, Garrett & Dunner, LLP

(57) **CLAIM**

The ornamental design for a bottle, as shown and described.

DESCRIPTION

FIG. 1 is a top, front perspective view of a bottle showing my new design;

FIG. 2 is a front elevation view thereof;

FIG. 3 is a rear elevation view thereof;

FIG. 4 is a left side view thereof;

FIG. 5 is a right side view thereof;

FIG. 6 is a top plan view thereof;

FIG. 7 is a bottom plan view thereof; and,

FIG. 8 is a sectional view of FIG. 1 thereof.

The dashed broken lines in the figures illustrate portions of the bottle that form no part of the claimed design.

1 Claim, 8 Drawing Sheets

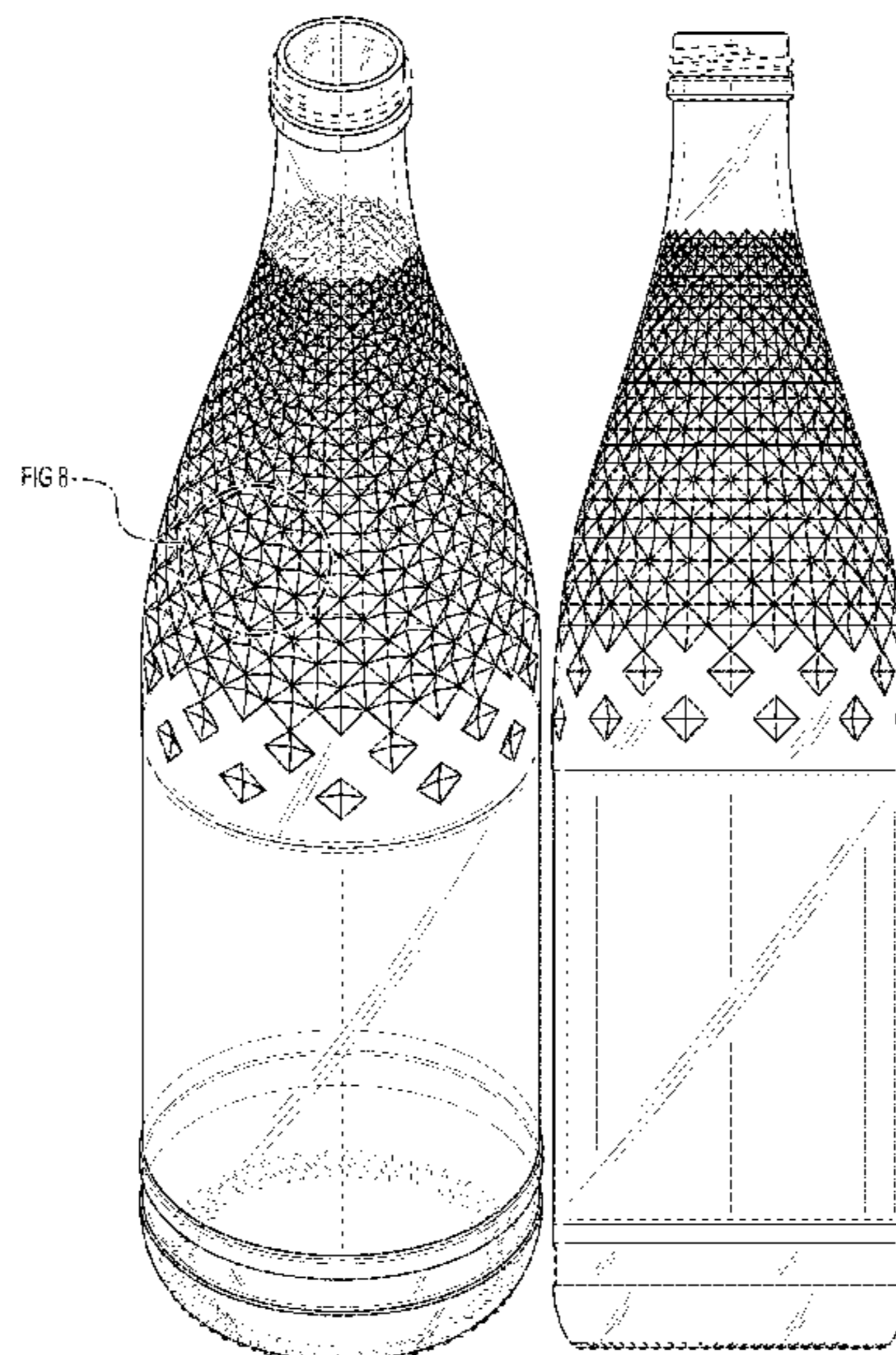

(56)

References Cited

U.S. PATENT DOCUMENTS

D848,267 S * 5/2019 Eisen D9/505
D848,851 S * 5/2019 Sullivan D9/553
D850,921 S * 6/2019 Shen D9/553
D863,059 S * 10/2019 Mazzer D9/500
D863,061 S * 10/2019 Granato D9/544
D869,280 S * 12/2019 Cecchetto D9/518

OTHER PUBLICATIONS

San Pellegrino Sparkling Natural Mineral Water, available May 13, 2016, [online], [site visited Jul. 10, 2020]. Available from internet, URL: https://www.amazon.com/San-Pellegrino-Sparkling-Natural-Mineral/dp/B0009JO5BW/ref=cm_cr_ar_p_d_product_top?ie=UTF8 (Year: 2016).*

Harrogate Sparkling Spring Water Glass, available Oct. 4, 2016[online], [site visited Jul. 10, 2020]. Available from internet, URL: https://www.amazon.co.uk/Harrogate-Spring-Water-Sparkling-ml-Pack/dp/B000NK088G/ref=cm_cr_ar_p_d_pdt_img_top?ie=UTF8 (Year: 2016).*

* cited by examiner

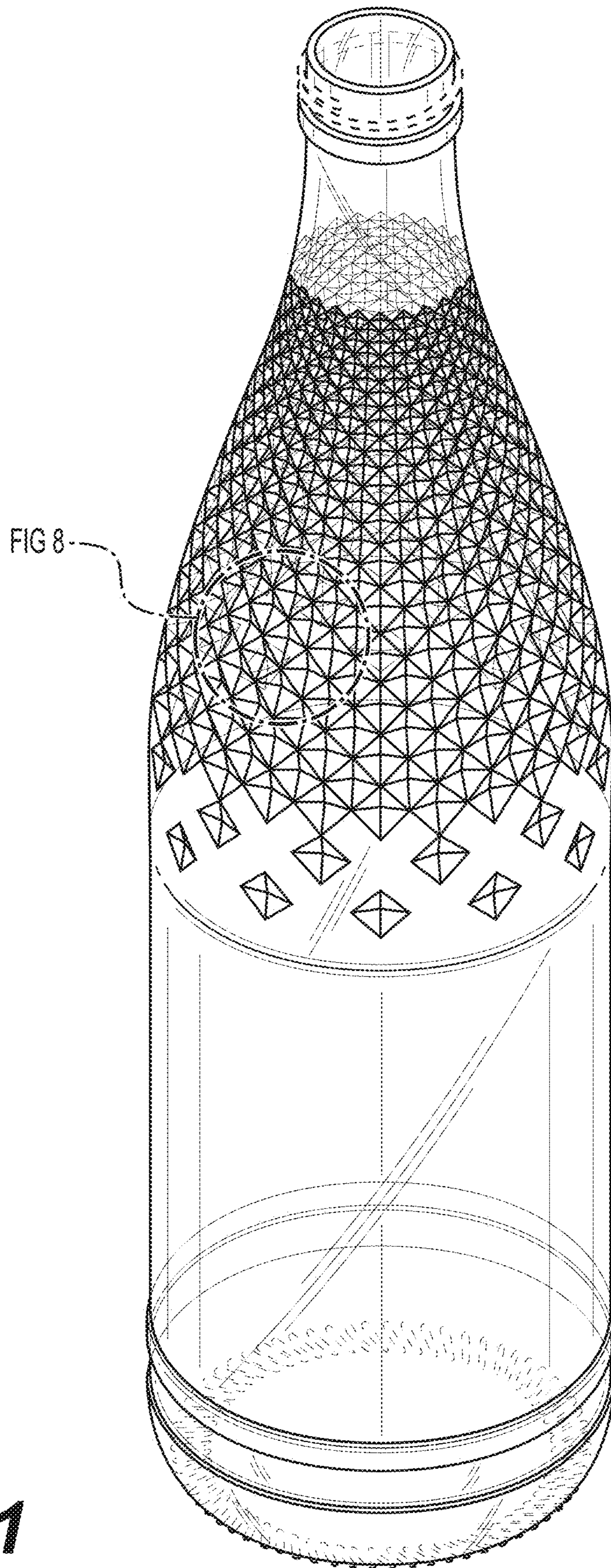

FIG. 1

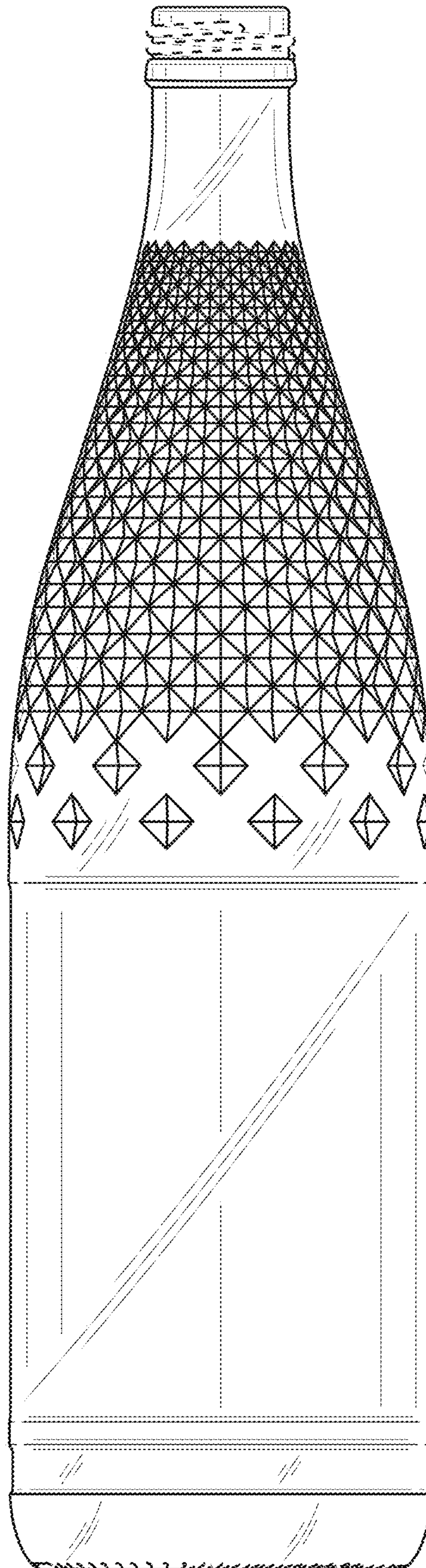

FIG. 2

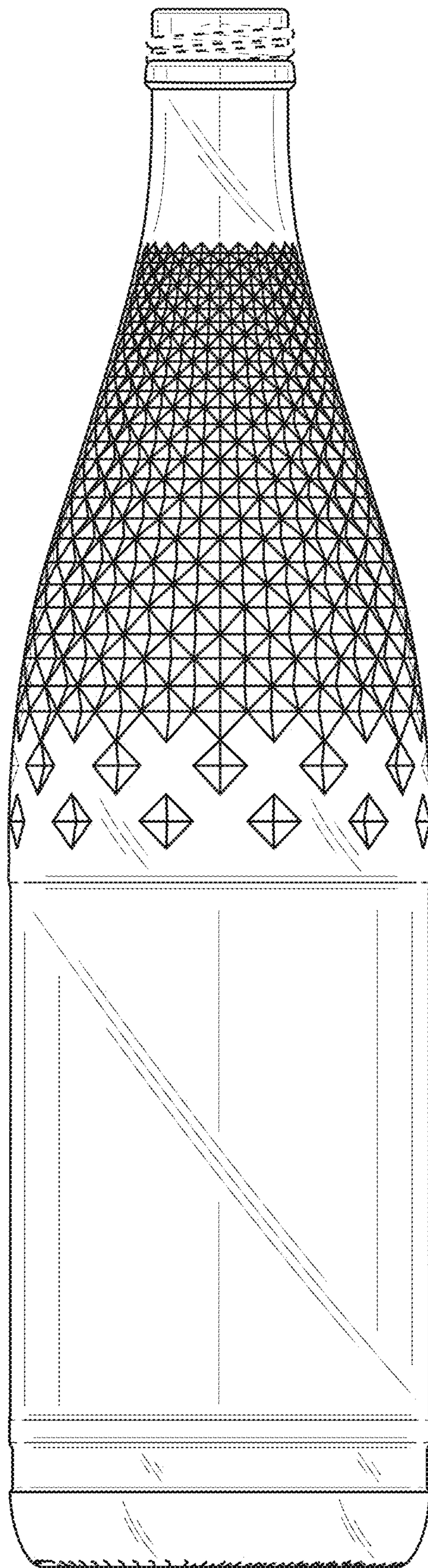

FIG. 3

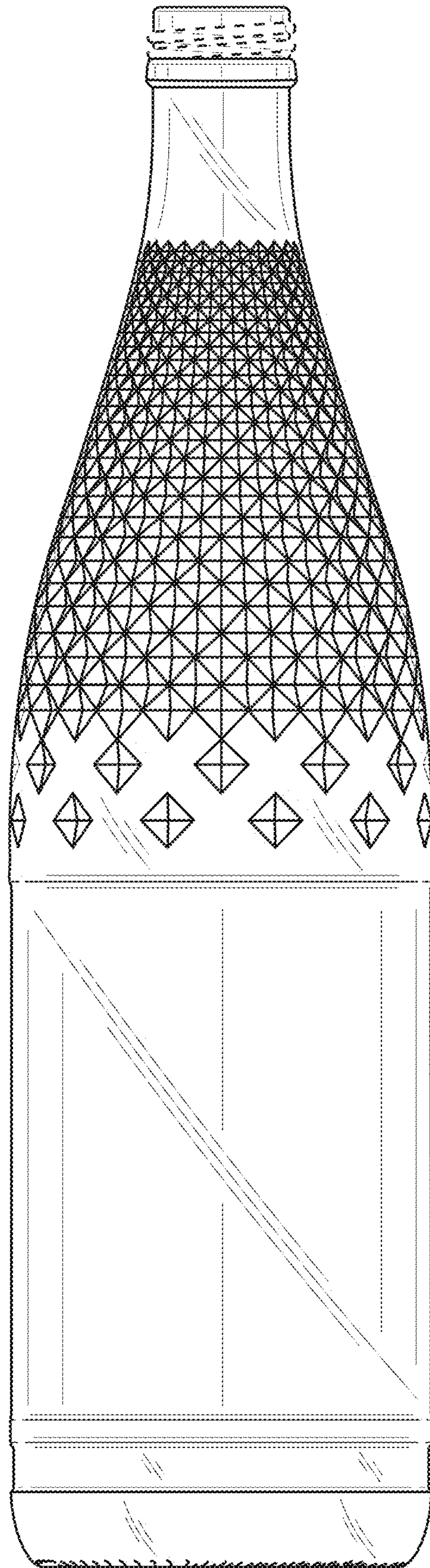

FIG. 4

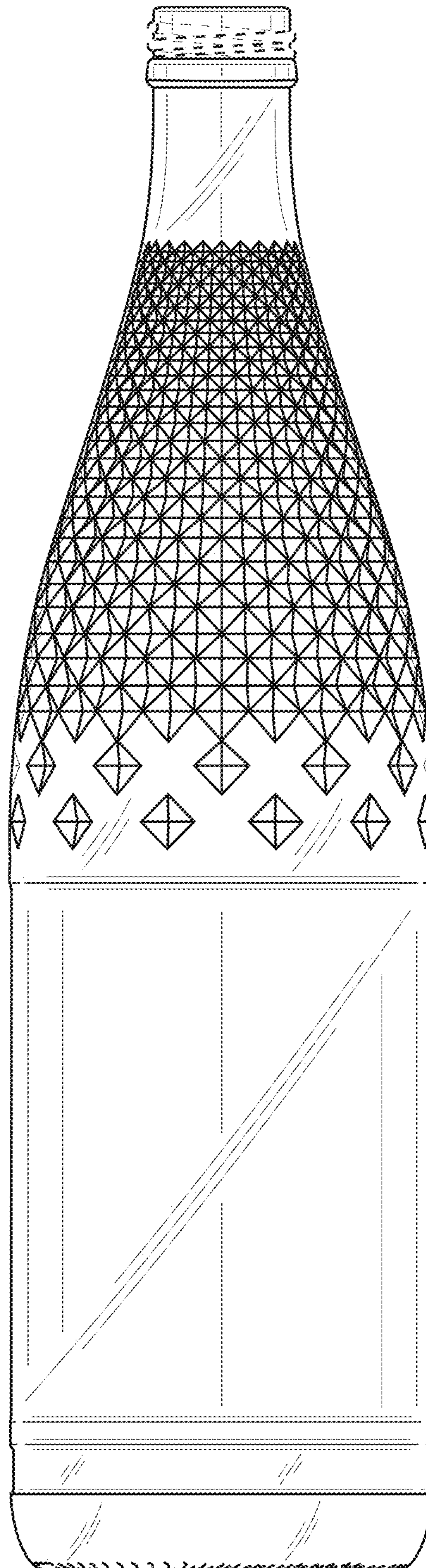

FIG. 5

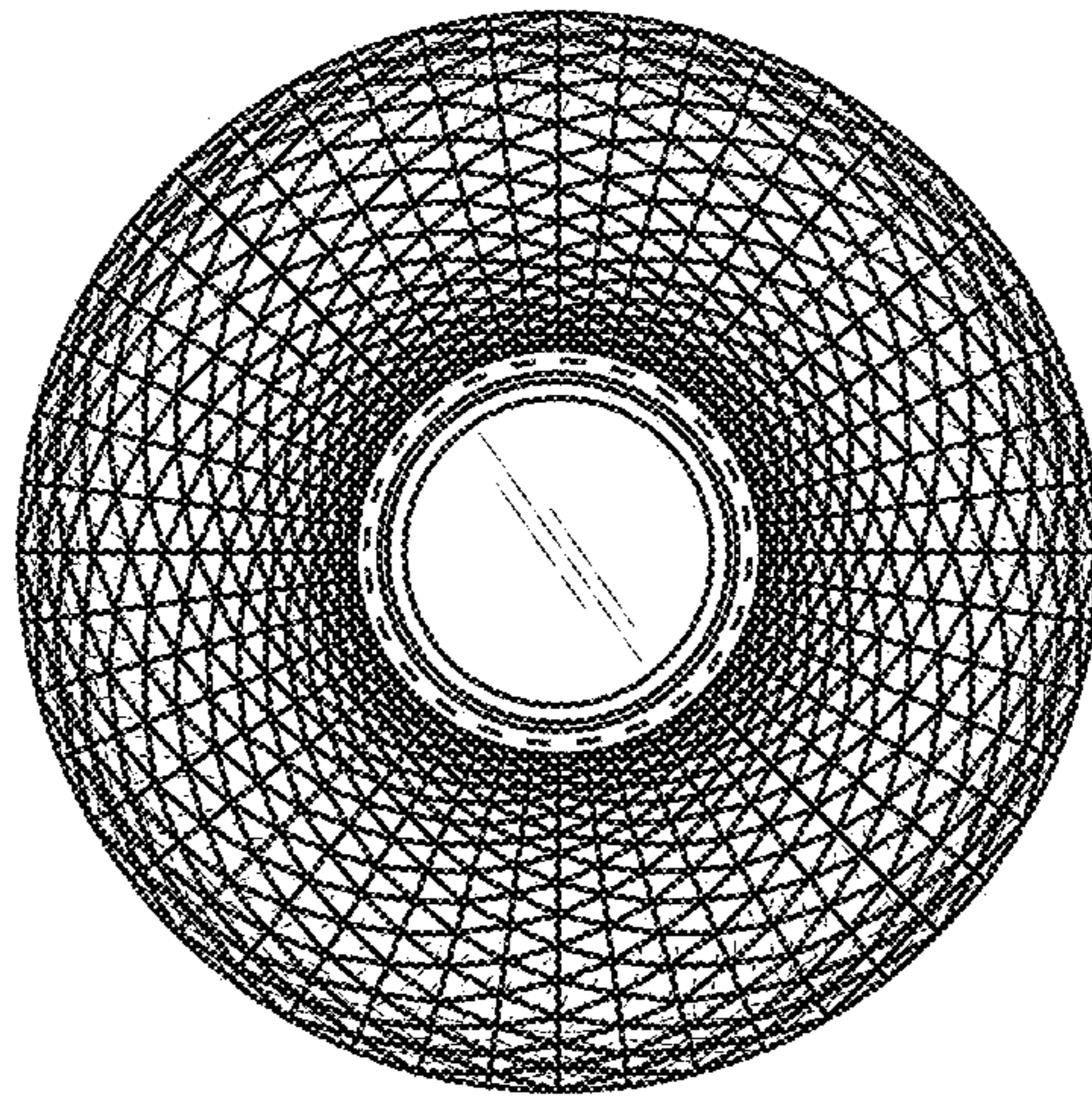

FIG. 6

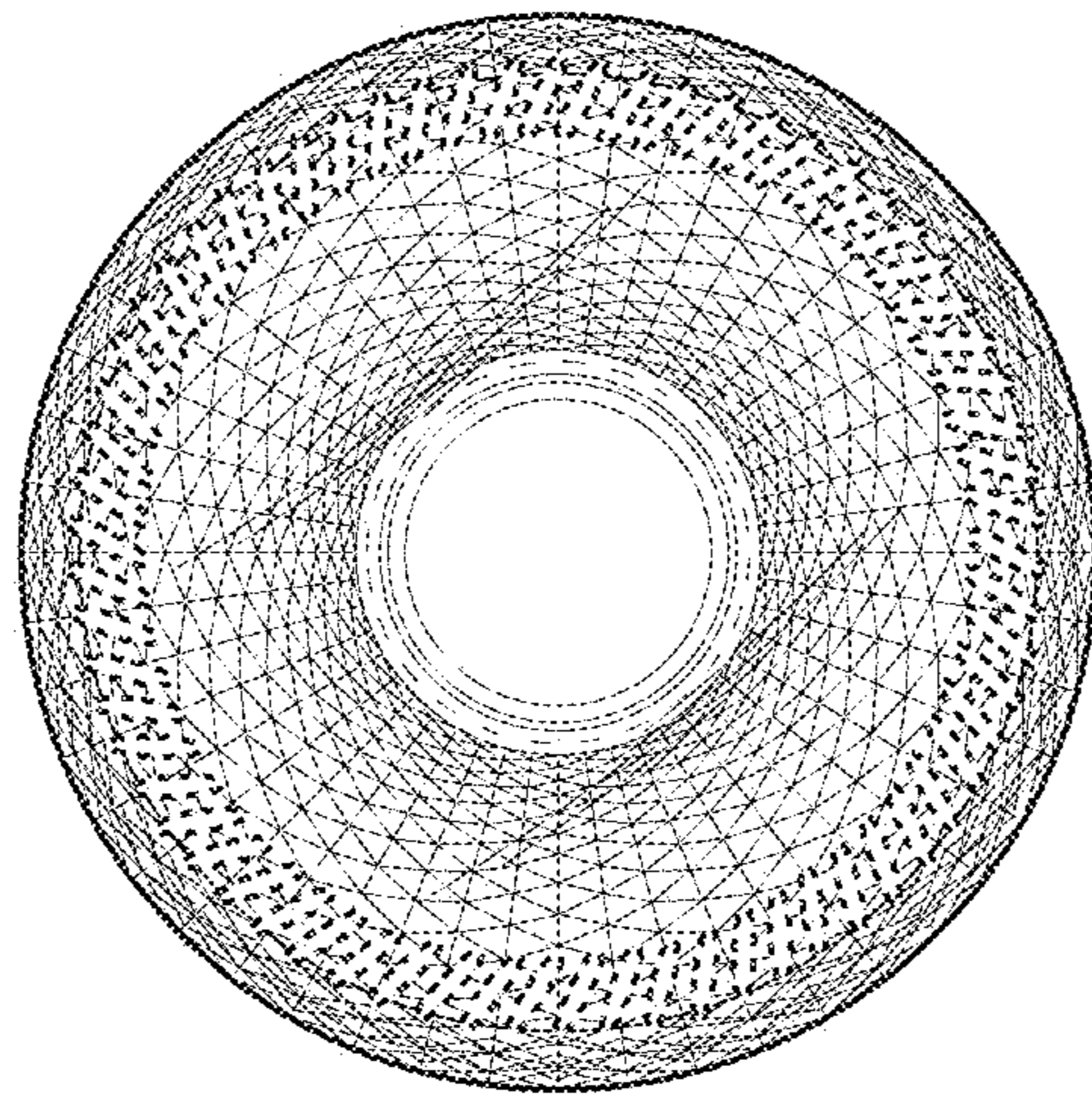

FIG. 7

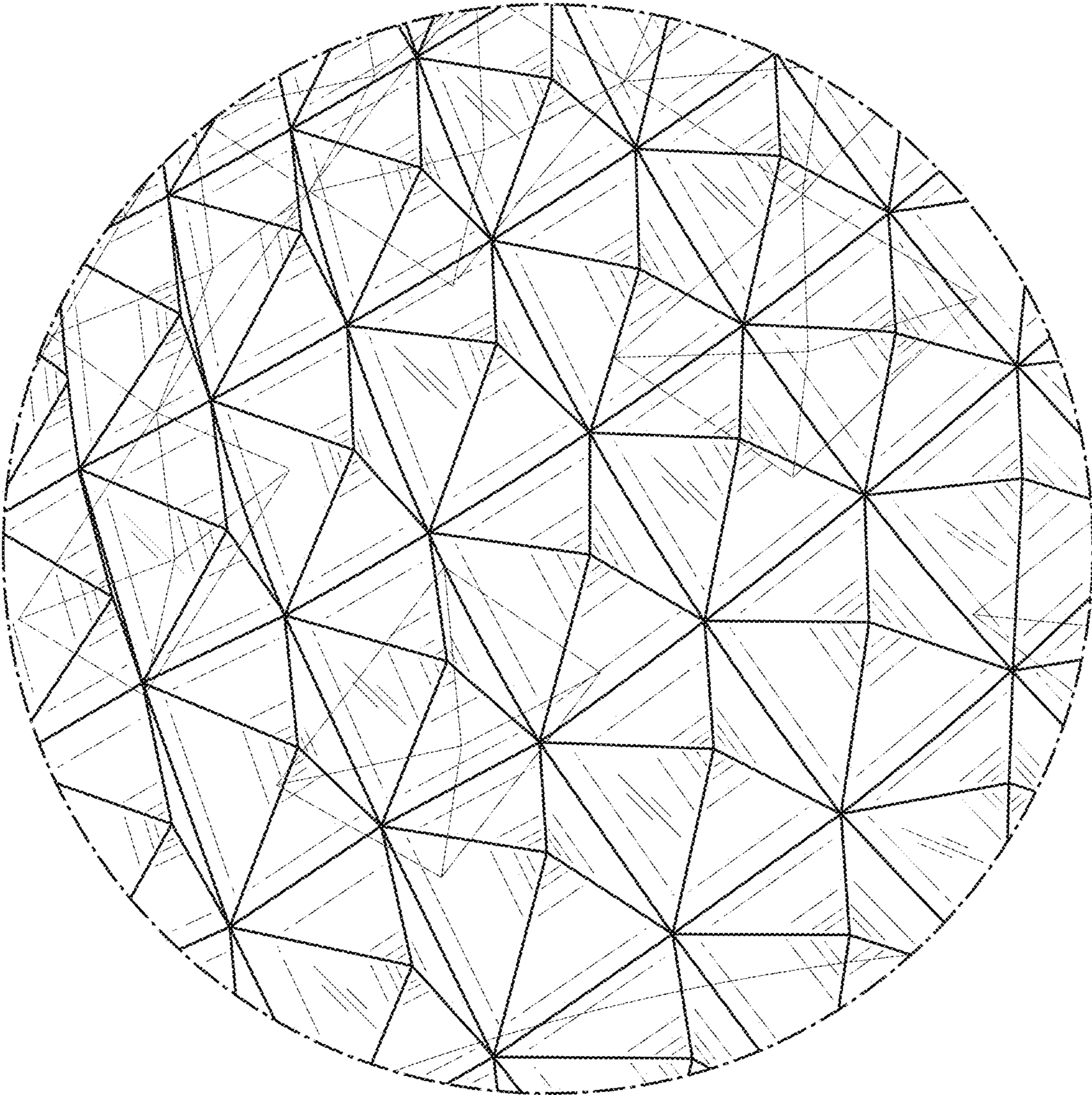

FIG. 8