



US00D902725S

(12) **United States Design Patent**
Shiota

(10) **Patent No.:** **US D902,725 S**

(45) **Date of Patent:** **** Nov. 24, 2020**

- (54) **JAR**
- (71) Applicant: **Emiko Shiota**, Tokyo (JP)
- (72) Inventor: **Emiko Shiota**, Tokyo (JP)
- (73) Assignee: **SHISEIDO CO., LTD.**, Tokyo (JP)
- (**) Term: **15 Years**
- (21) Appl. No.: **29/693,464**
- (22) Filed: **Jun. 3, 2019**
- (51) **LOC (12) Cl.** **09-01**
- (52) **U.S. Cl.**
USPC **D9/504; D9/454; D9/503**
- (58) **Field of Classification Search**
USPC D9/414, 434-435, 454, 500, 503-504,
D9/516, 529, 549, 558, 715, 719;
D28/73, 76
CPC B65D 1/00; B65D 1/02; B65D 1/0223;
B65D 23/00; B65D 51/32; B65D
2501/00; B65D 2501/0009
See application file for complete search history.

(56) **References Cited**

U.S. PATENT DOCUMENTS

- D226,753 S * 4/1973 Quintal D9/503
- D247,548 S * 3/1978 Crary D7/540
- D306,826 S * 3/1990 Bormioli D9/504
- D391,162 S * 2/1998 Kokenge D9/504

- D411,747 S * 6/1999 Kokenge D9/454
- D422,218 S * 4/2000 Ohchi D9/454
- D474,405 S * 5/2003 Togasawa D9/504
- D574,710 S * 8/2008 Gangrade D9/504
- D634,638 S * 3/2011 L'Abbate D9/529
- D634,639 S * 3/2011 L'Abbate D9/529
- D635,030 S * 3/2011 L'Abbate D9/529
- D638,300 S * 5/2011 L'Abbate D9/529
- 8,479,940 B2 * 7/2013 Marra B65D 23/0885
220/23.87
- D702,555 S * 4/2014 Park D9/504
- D703,055 S * 4/2014 Park D9/504
- D746,140 S * 12/2015 Watabe D9/503
- D746,141 S * 12/2015 Watabe D9/503
- D746,147 S * 12/2015 Watabe D9/552
- D852,630 S * 7/2019 Nagata D9/503

* cited by examiner

Primary Examiner — Dana Meyrow

(74) *Attorney, Agent, or Firm* — Manabu Kanesaka

(57) **CLAIM**

The ornamental design for a jar, as shown and described.

DESCRIPTION

FIG. 1 is a perspective view of a jar showing my new design;
 FIG. 2 is a front view thereof;
 FIG. 3 is a rear view thereof;
 FIG. 4 is a top plan view thereof;
 FIG. 5 is a bottom plan view thereof;
 FIG. 6 is a left side view thereof; and,
 FIG. 7 is a right side view thereof.

1 Claim, 2 Drawing Sheets

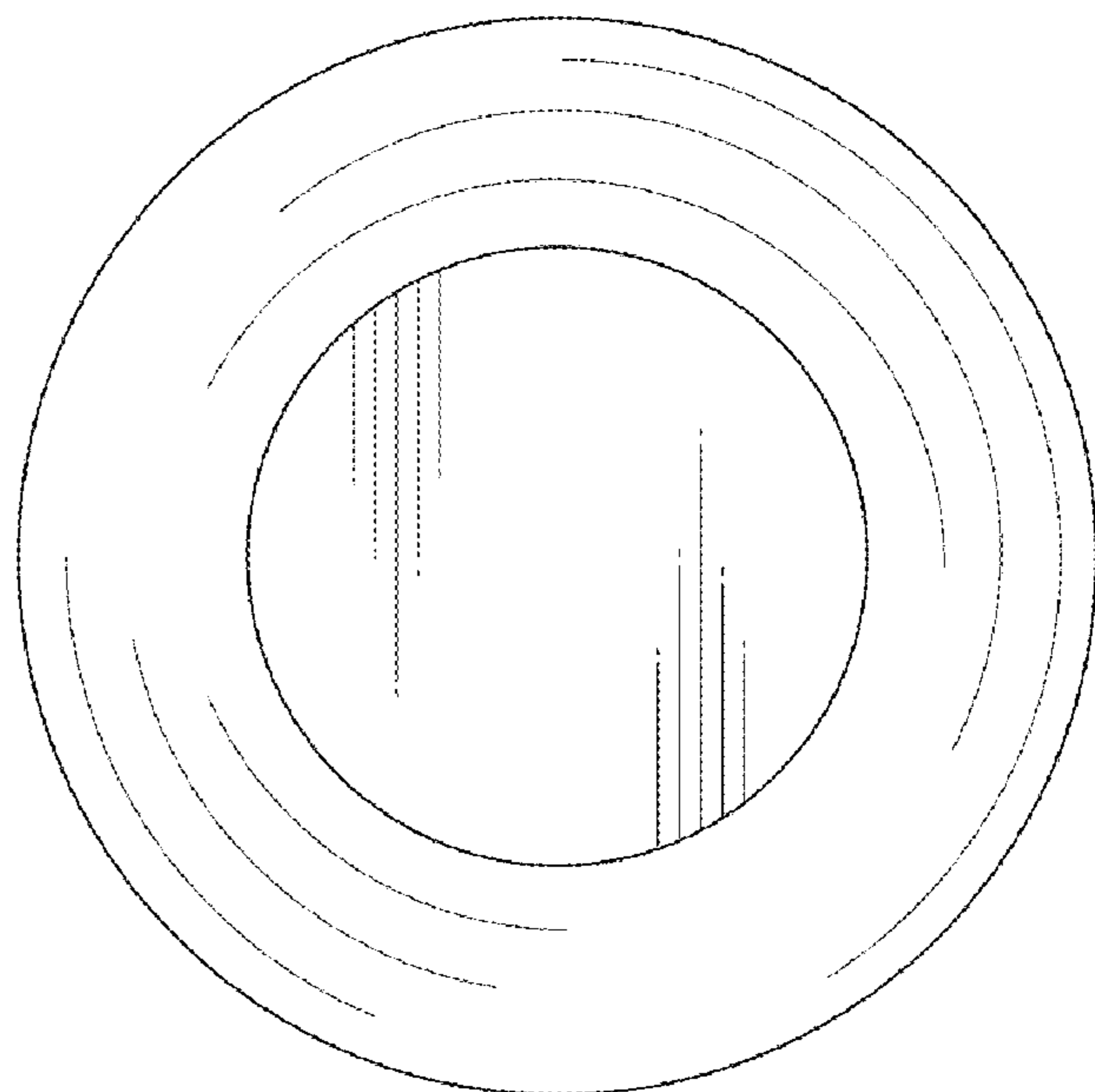
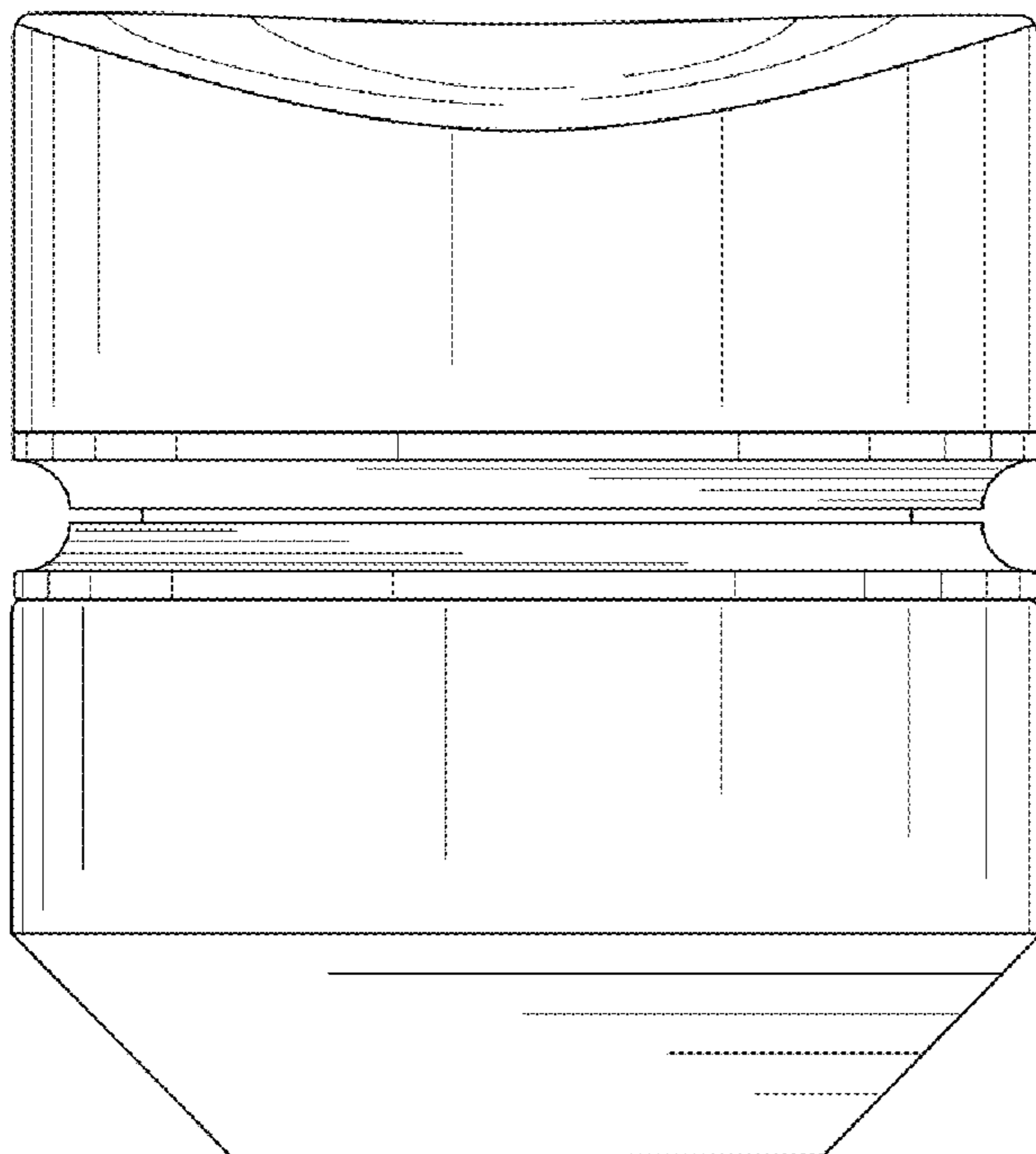

Fig.1

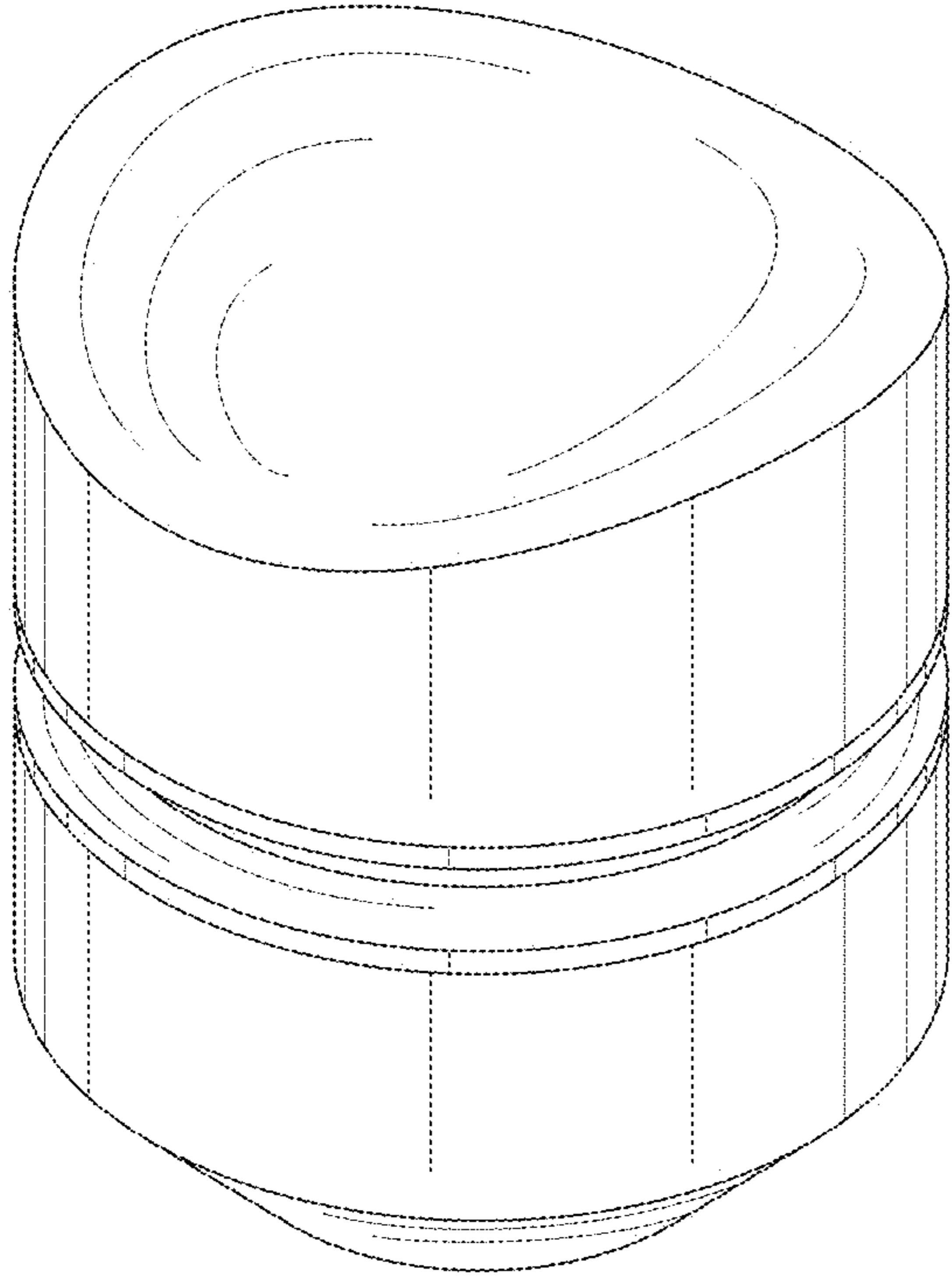

Fig.2

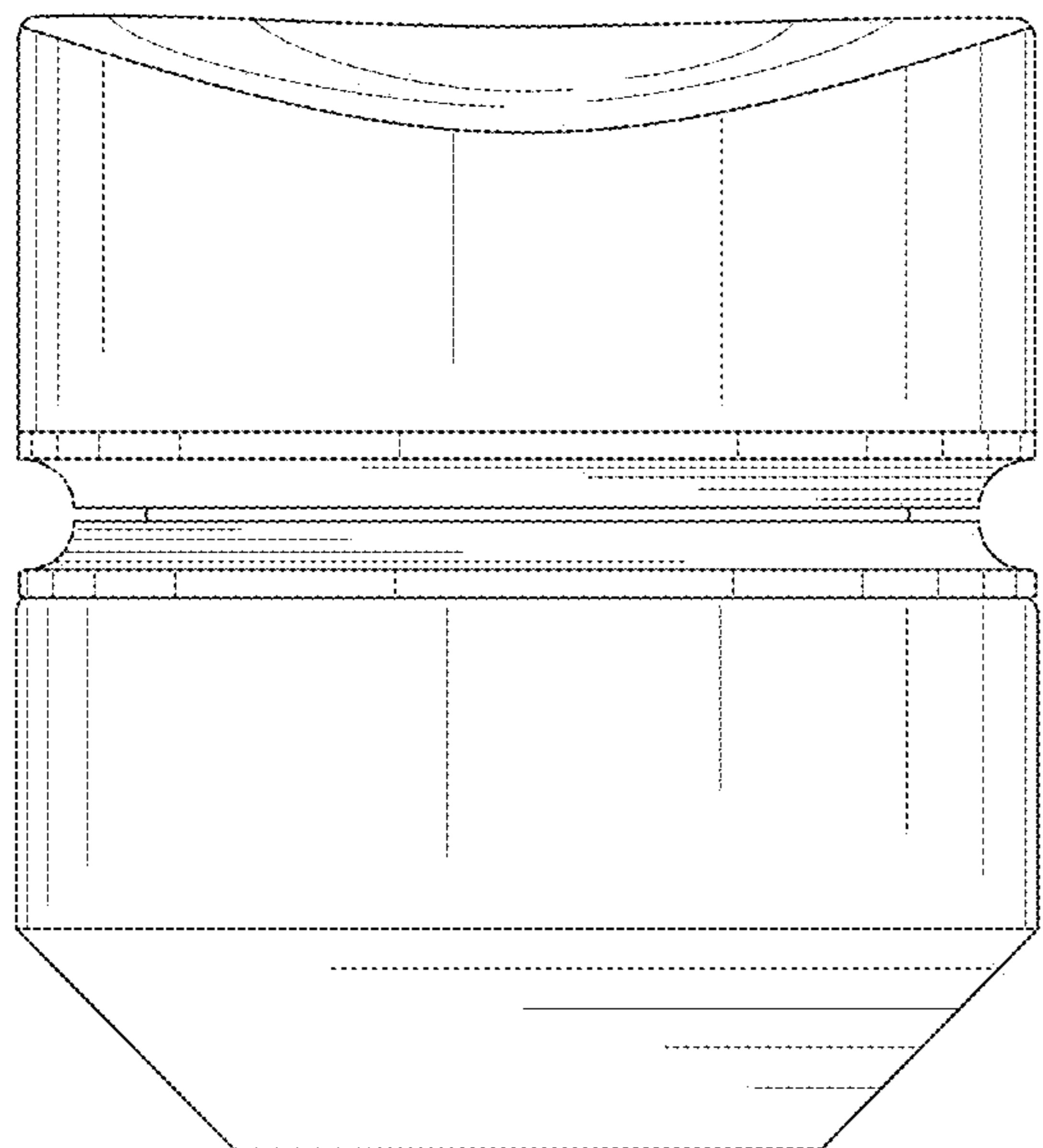

Fig.3

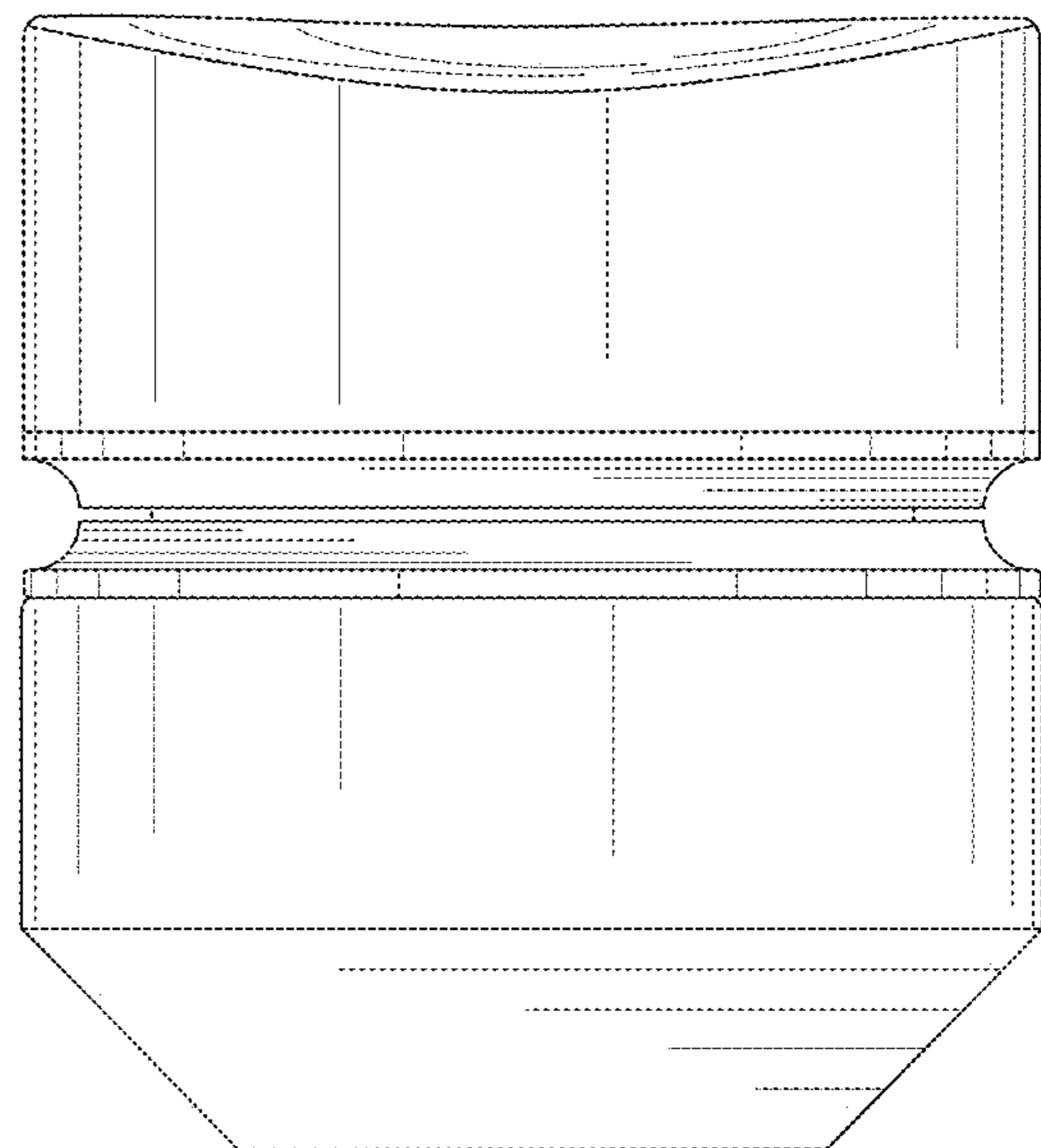

Fig.4

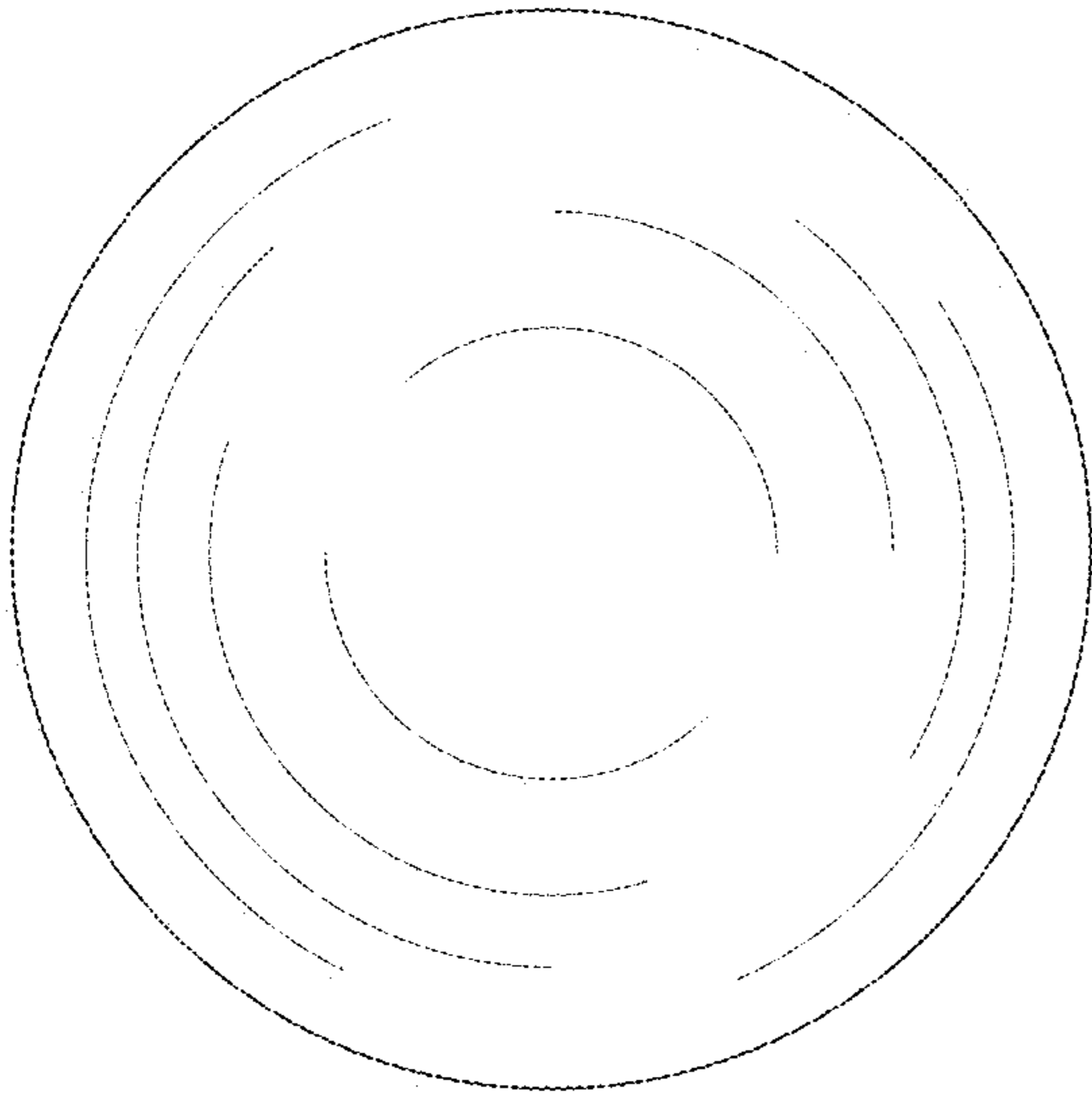

Fig.5

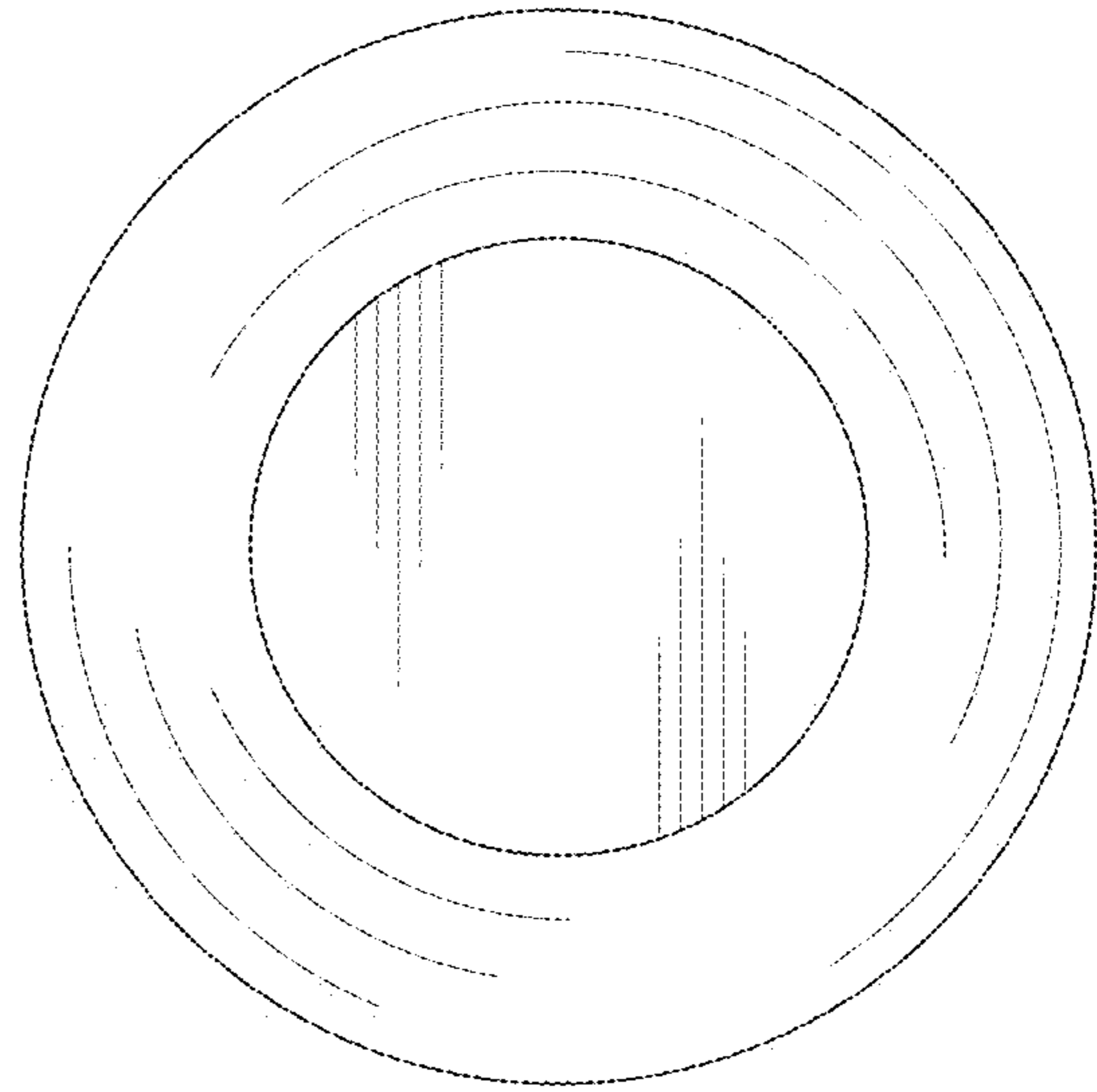

Fig.6

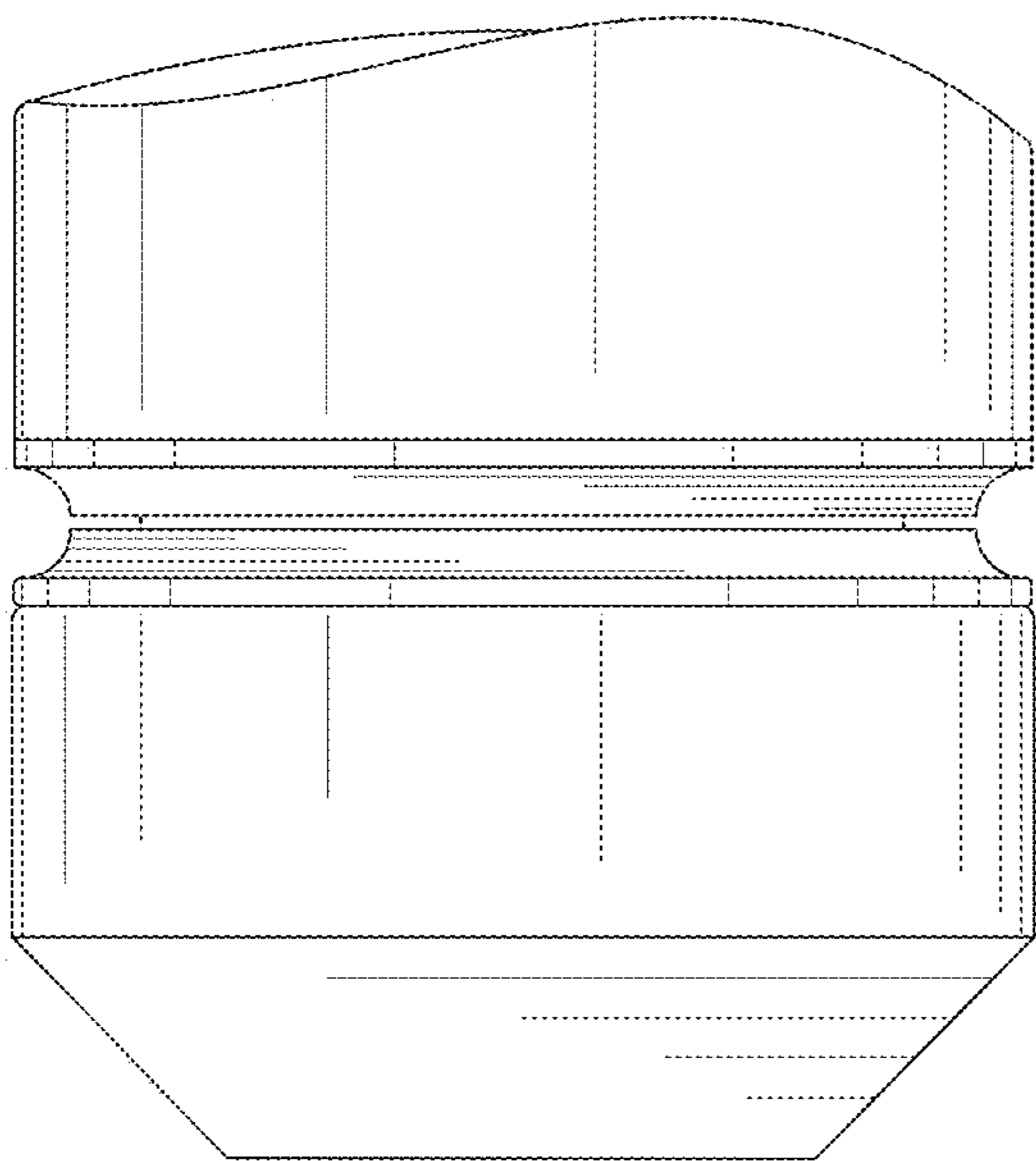

Fig.7

