



US00D902654S

(12) **United States Design Patent** (10) **Patent No.:** **US D902,654 S**
Davies (45) **Date of Patent:** **** Nov. 24, 2020**

(54) **DRINKING CUP**

(56) **References Cited**

(71) Applicant: **KONINKLIJKE PHILIPS N.V.**,
Eindhoven (NL)

U.S. PATENT DOCUMENTS

(72) Inventor: **Ben Davies**, Eindhoven (NL)

D315,213 S *	3/1991	Ohnuki	D24/197
D368,529 S *	4/1996	Allegre	D24/197
D476,849 S *	7/2003	Randolph	D7/510
D495,558 S *	9/2004	Tollman	D7/510
D507,151 S *	7/2005	Schuler	D7/509
D515,867 S *	2/2006	Randolph	D7/392.1
D520,809 S *	5/2006	Randolph	D7/392.1
D545,131 S *	6/2007	Seum	D7/509
D551,021 S *	9/2007	Rouso	D7/510
D559,624 S *	1/2008	Carreno	D7/510
D579,721 S *	11/2008	Qian	D7/507
D616,706 S *	6/2010	Bofinger	D7/534
D625,424 S *	10/2010	MacKay	D24/197
D627,599 S *	11/2010	Richau	D7/510
D635,684 S *	4/2011	Shaikh	D24/197
D642,435 S *	8/2011	Schofield	D7/510
D642,866 S *	8/2011	Schofield	D7/510
8,256,642 B2 *	9/2012	McNamara	A47G 19/2272 220/714
D675,877 S *	2/2013	Thomas	D7/534
D676,709 S *	2/2013	Thomas	D7/534
D679,948 S *	4/2013	Meyer	D7/534
D683,185 S *	5/2013	Thomas	D7/510
D684,426 S *	6/2013	Bottomley	D7/516
D688,099 S *	8/2013	Hsu	D7/534

(73) Assignee: **KONINKLIJKE PHILIPS N.V.**,
Eindhoven (NL)

(**) Term: **15 Years**

(21) Appl. No.: **29/675,292**

(22) Filed: **Dec. 31, 2018**

Related U.S. Application Data

(62) Division of application No. 35/502,584, filed on Sep. 9, 2016 (U.S. filing date under 35 U.S.C. 384), and having an international filing date of Sep. 9, 2016, now Pat. No. Des. 836,986.

Foreign Application Priority Data

Apr. 21, 2016 (EM) 003076983-0001

(51) **LOC (12) Cl.** **07-01**

(52) **U.S. Cl.**
USPC **D7/510; D7/511; D7/516; D7/534;**
D24/197

CPC **A47G 19/22** (2013.01)

(58) **Field of Classification Search**

USPC D7/509-516, 523, 326, 533-535, 543,
D7/548, 300, 312-320, 598, 589, 396.2;
D10/46.2; D24/197-199; D19/85;
220/703, 714, 710, 710.5, 212.5
CPC A47G 19/22; A47G 19/2266; A47G
19/2272; A61J 9/00; A61J 9/06; A61J
9/08; A61J 9/085

See application file for complete search history.

(Continued)

Primary Examiner — Richard E Chilcot

(57) **CLAIM**

The ornamental design for a drinking cup, as shown.

DESCRIPTION

FIG. 1 is a perspective view showing my design;
FIG. 2 is a front elevational view thereof;
FIG. 3 is a rear elevational view thereof;
FIG. 4 is a right side elevational view thereof;
FIG. 5 is a left side elevational view thereof;
FIG. 6 is a top plan view thereof; and,
FIG. 7 is a bottom plan view thereof.

1 Claim, 6 Drawing Sheets

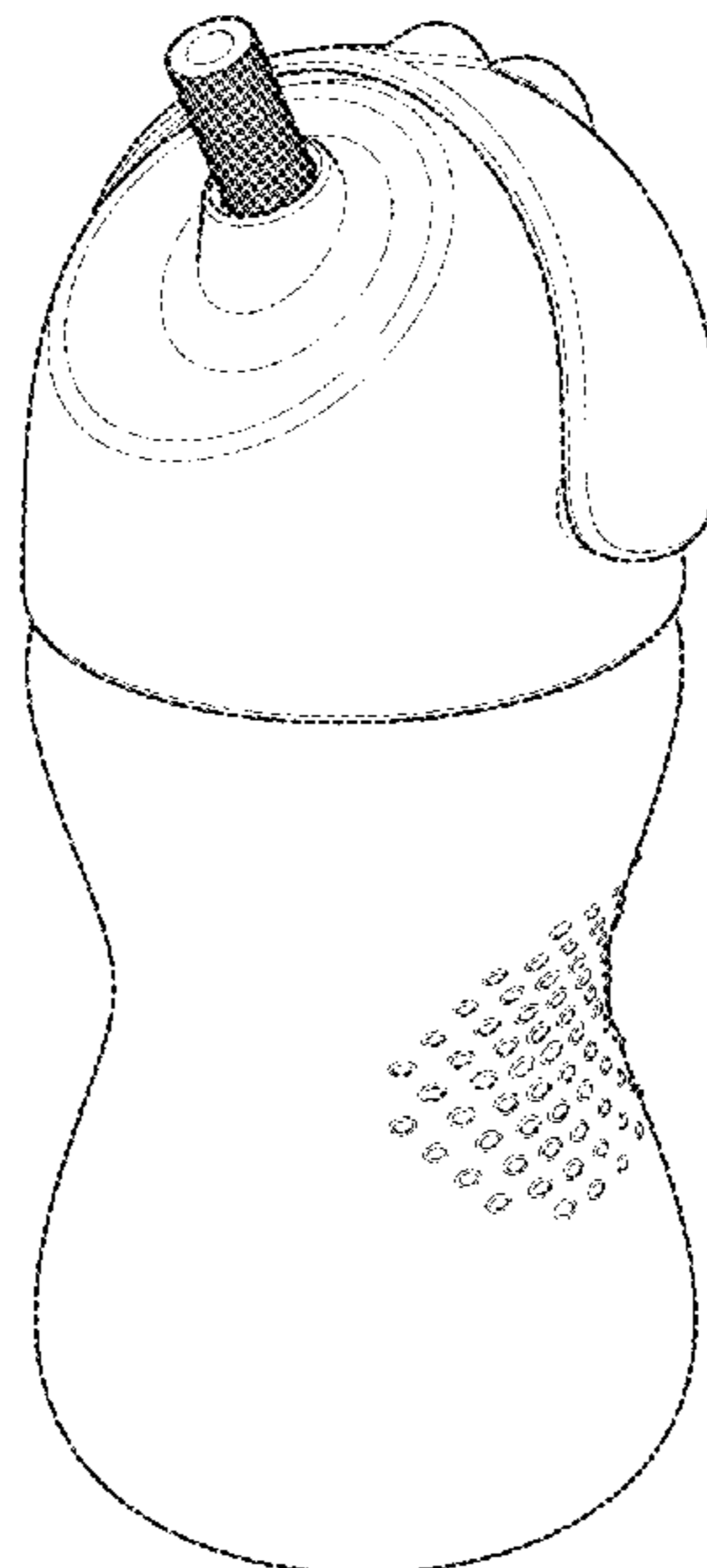

(56)

References Cited

U.S. PATENT DOCUMENTS

8,573,436	B2 *	11/2013	Moore	A61J 11/008 220/714
D713,687	S *	9/2014	Lv	D7/510
D718,087	S *	11/2014	Marasligiller	D7/396.2
D718,090	S *	11/2014	Roehrig	D7/510
D730,697	S *	6/2015	Johnson	D7/534
D734,095	S *	7/2015	Thomas	D7/510
D747,920	S *	1/2016	Hakim	D7/396.2
D748,435	S *	2/2016	Thalmann	D7/534
D763,624	S *	8/2016	Parker	D7/534
D764,235	S *	8/2016	Parker	D7/534
D793,167	S *	8/2017	Schlegel	D7/534
D796,262	S *	9/2017	Parker	D7/510
D796,906	S *	9/2017	Schlegel	D7/534
D809,875	S *	2/2018	Delgado Carmona	D7/628
D819,401	S *	6/2018	Parker	D7/510
2003/0218015	A1 *	11/2003	Randolph	B65D 25/28 220/212.5
2005/0098567	A1 *	5/2005	Randolph	B65D 47/06 220/710.5

* cited by examiner

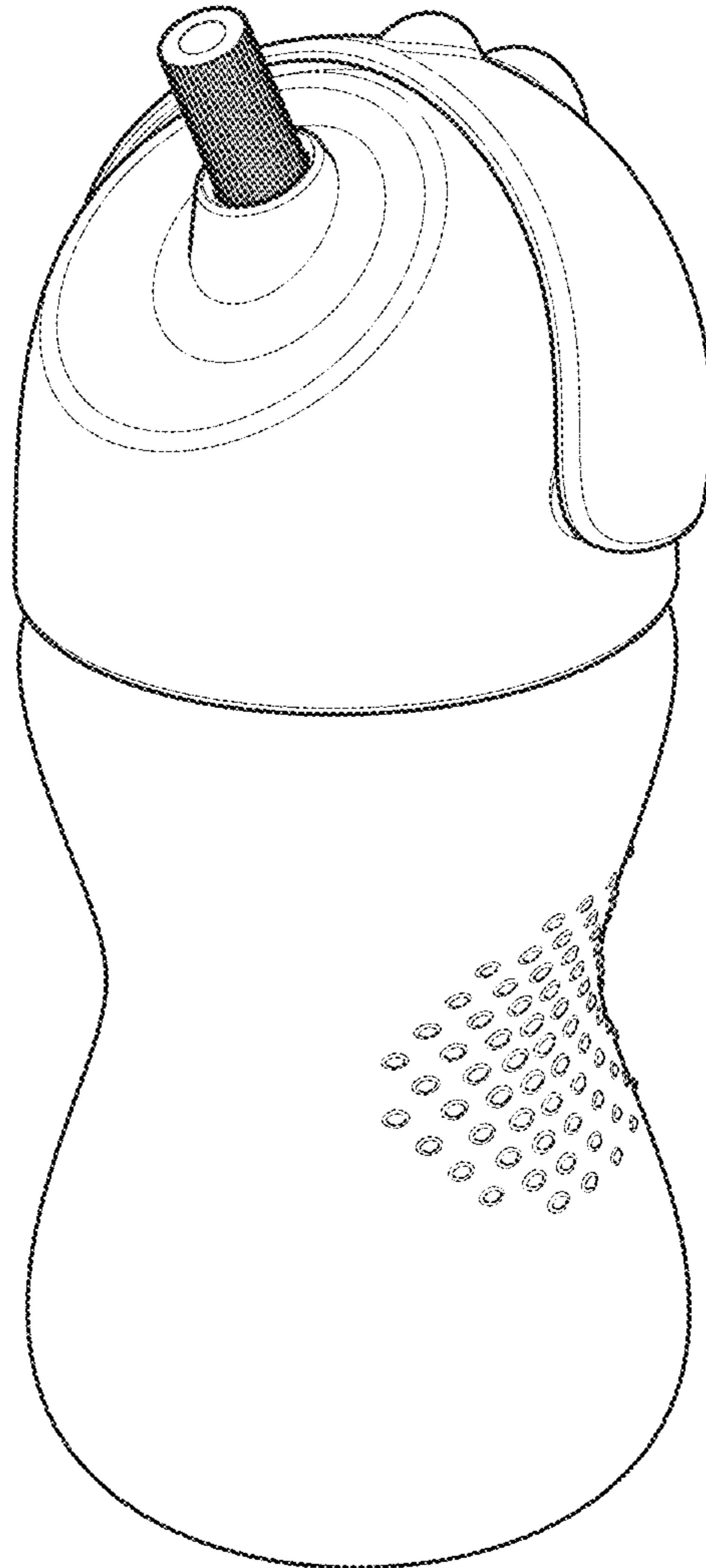

FIG. 1

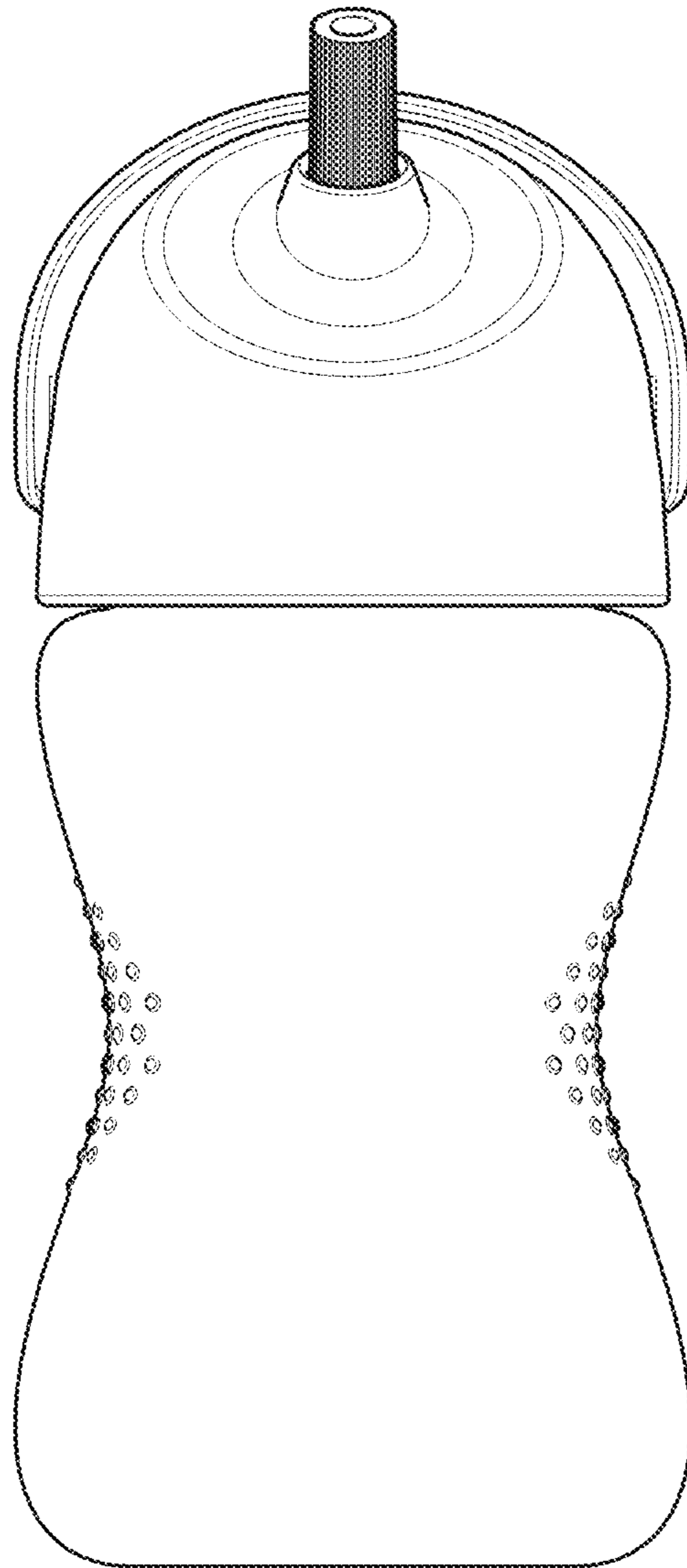

FIG. 2

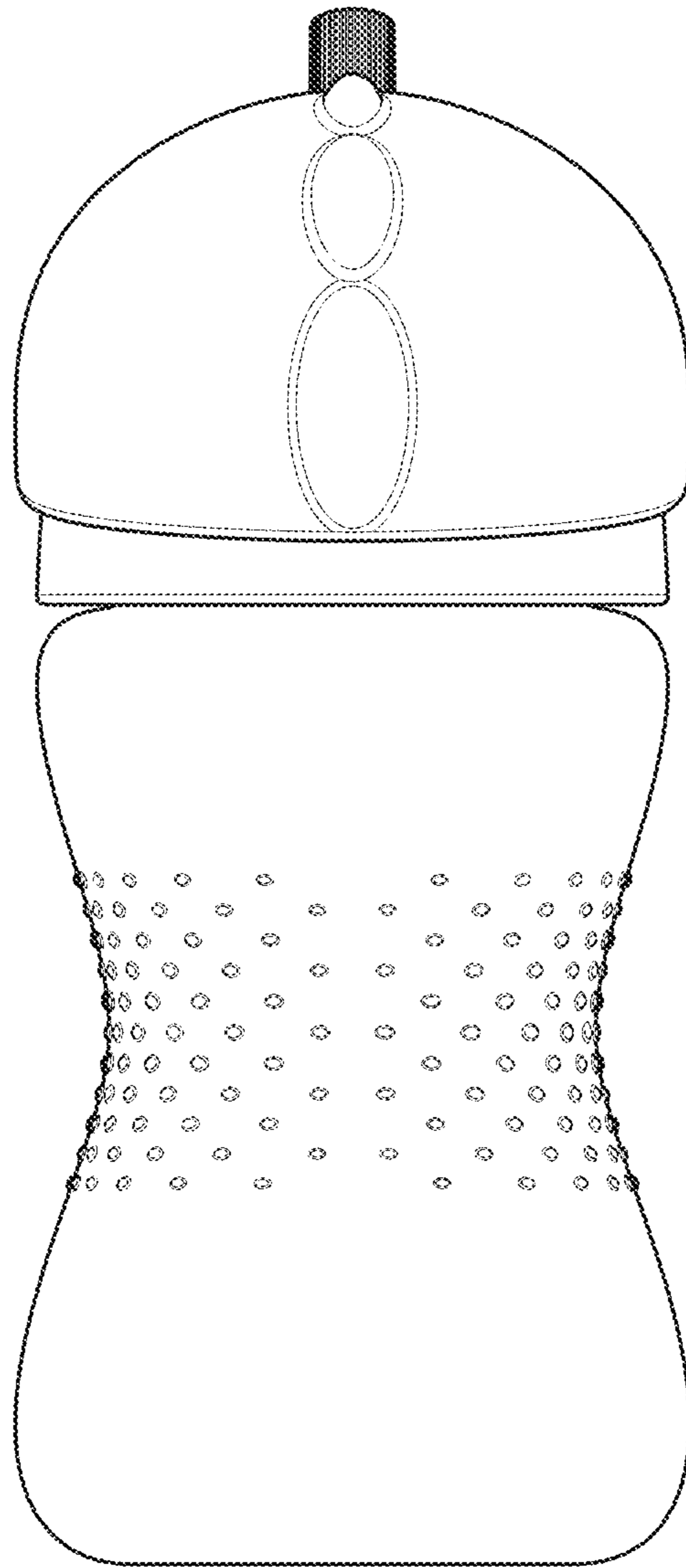

FIG. 3

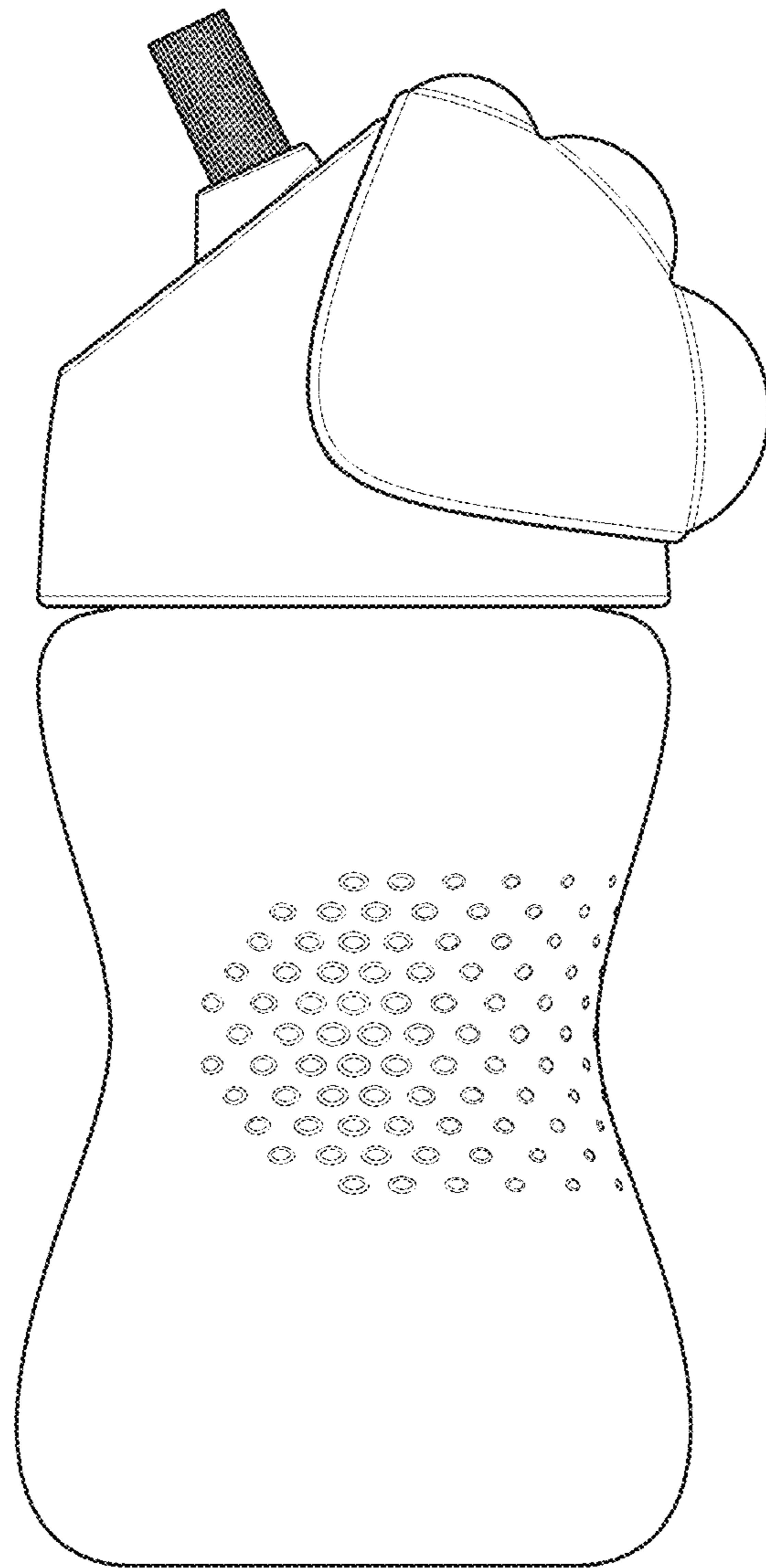

FIG. 4

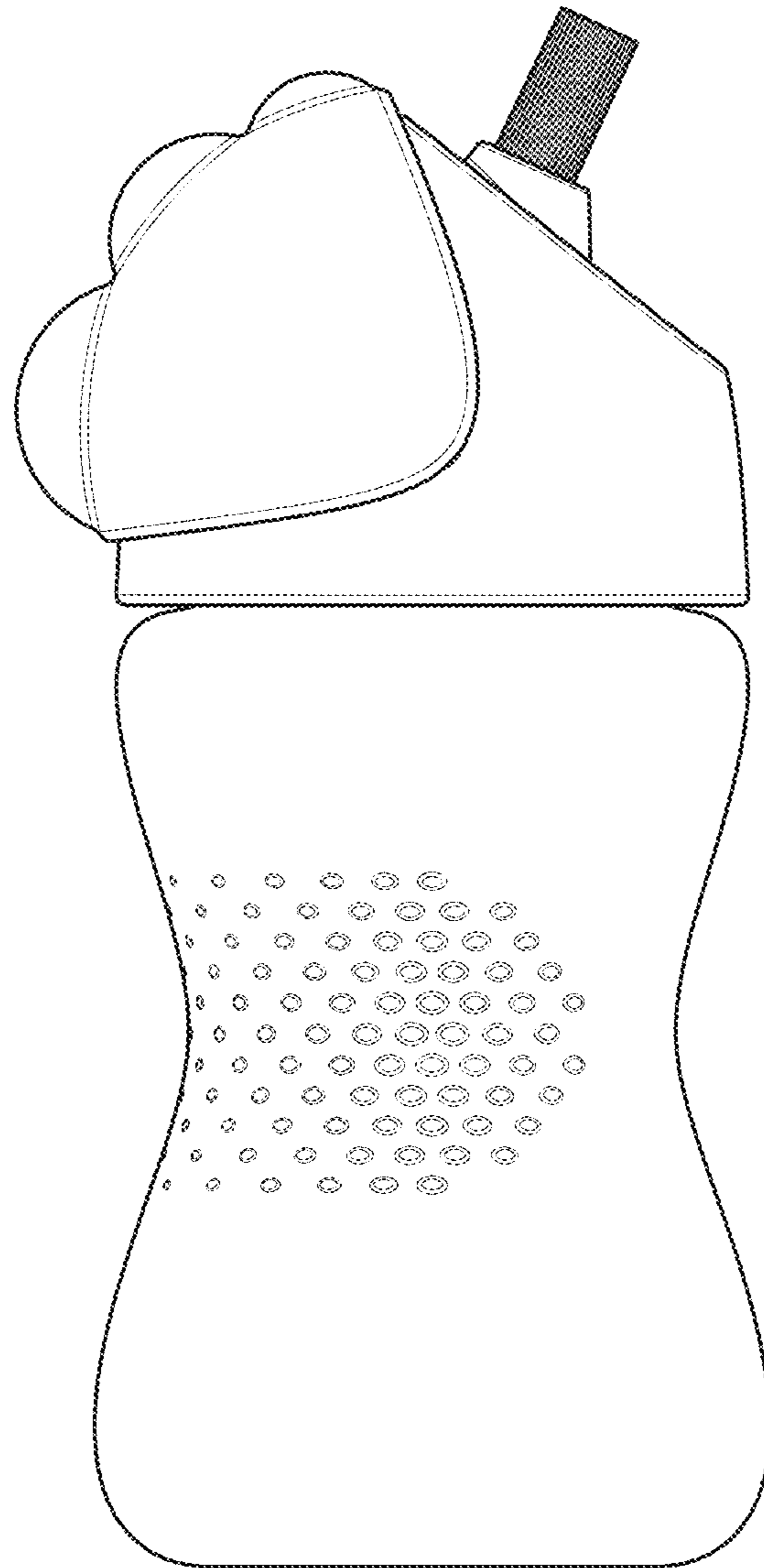

FIG. 5

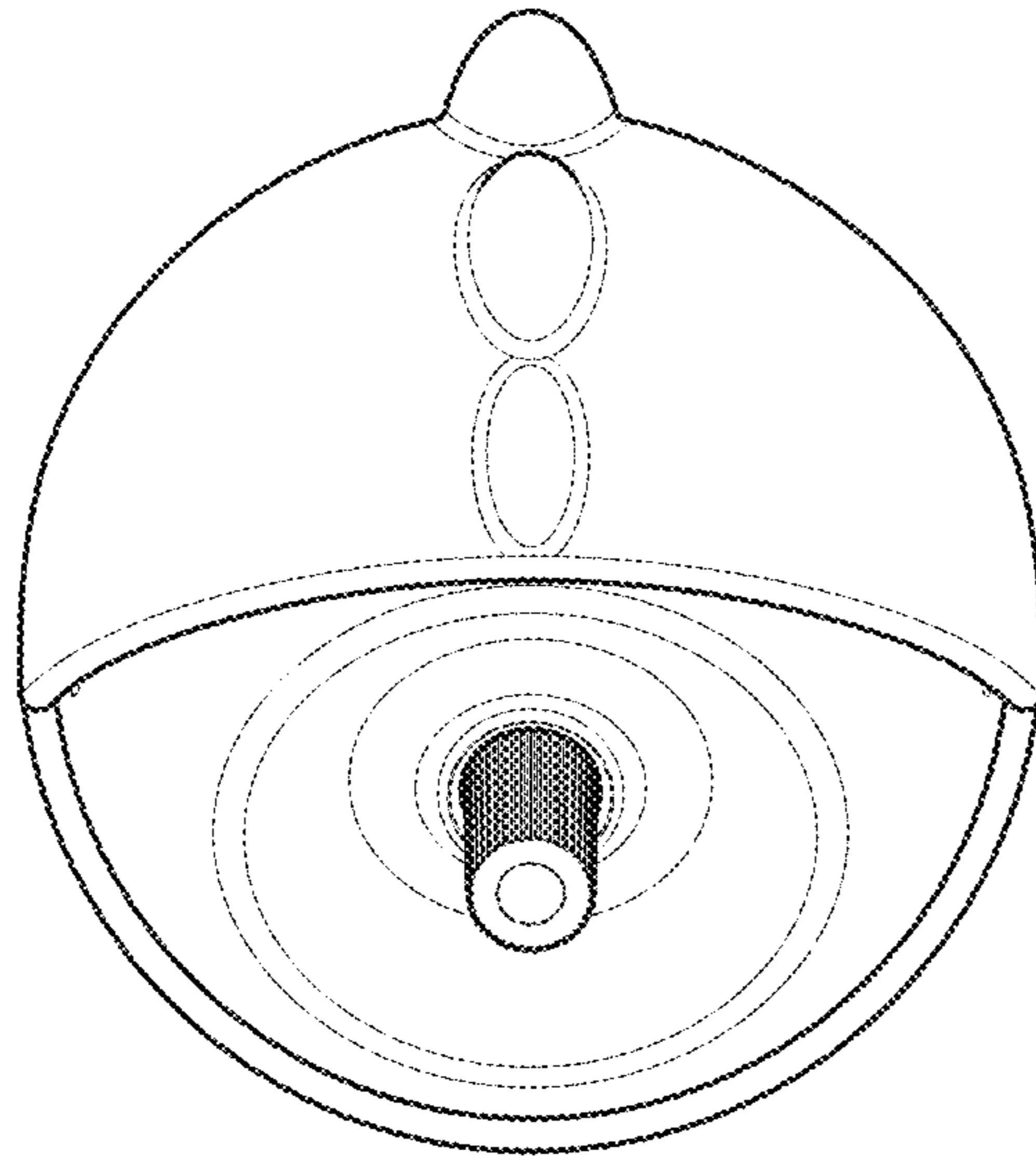

FIG. 6

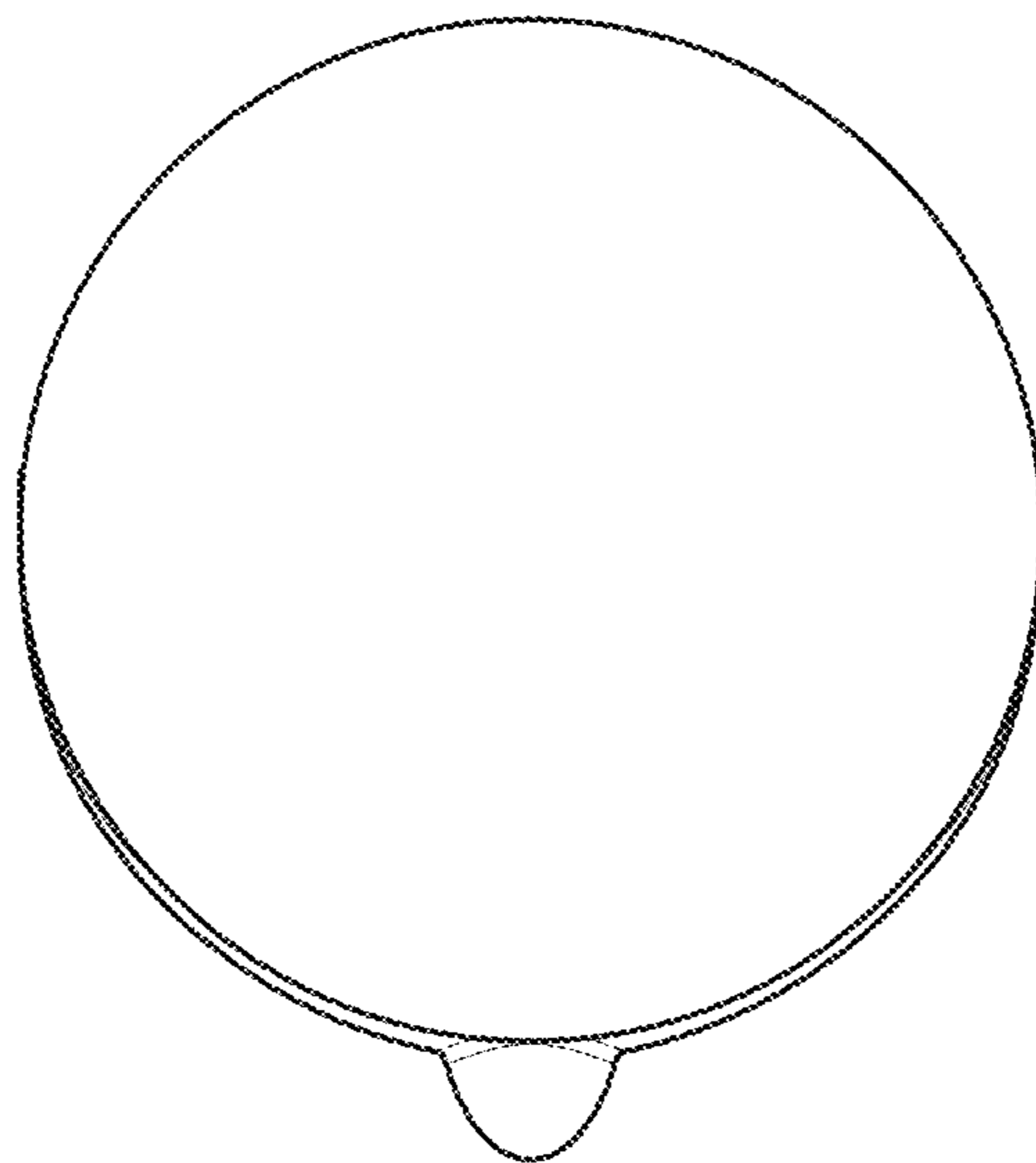

FIG. 7