



US00D902643S

(12) **United States Design Patent**
Park et al.

(10) **Patent No.:** **US D902,643 S**

(45) **Date of Patent:** **** Nov. 24, 2020**

(54) **STOPPER FOR BEVERAGE BOTTLE**

(71) Applicants: **Jennifer Bae Park**, Chicago, IL (US);
Marvin Lane, Wheeling, IL (US);
Dwayne Boroski, Lake in the Hills, IL (US)

(72) Inventors: **Jennifer Bae Park**, Chicago, IL (US);
Marvin Lane, Wheeling, IL (US);
Dwayne Boroski, Lake in the Hills, IL (US)

(73) Assignee: **Thermos L.L.C.**, Schaumburg, IL (US)

(**) Term: **15 Years**

(21) Appl. No.: **29/656,717**

(22) Filed: **Jul. 16, 2018**

(51) **LOC (12) Cl.** **07-02**

(52) **U.S. Cl.**
USPC **D7/391**

(58) **Field of Classification Search**

USPC D7/391, 392, 392.1, 393, 397, 629;
D9/414, 424-432, 435, 439, 443,
D9/451-453

CPC A47J 36/027; A47J 36/06; A47J 37/10;
A47J 37/101; B65D 21/0209; B65D
43/00; B65D 43/02; B65D 43/022; B65D
43/161; B65D 43/162; B65D 45/00;
B65D 45/16; B65D 45/18; B65D
39/0017; B65D 51/16; B65D 51/1683;
B65D 51/1688; B65D 51/1694; B65F
1/1615

See application file for complete search history.

(56) **References Cited**

U.S. PATENT DOCUMENTS

D219,806 S * 2/1971 Coleman D9/439
3,716,163 A * 2/1973 Marcel B65D 39/0017
215/320

D375,019 S * 10/1996 Goto D7/392.1
D381,243 S * 7/1997 Goto D7/392
D562,462 S * 2/2008 Muir D24/224
D587,580 S * 3/2009 Kane D9/453
D604,120 S * 11/2009 Curtin D7/629
D621,707 S * 8/2010 Breckan D9/443
D632,958 S * 2/2011 Fuchs D9/453
D634,200 S * 3/2011 Taber D9/453
D723,919 S * 3/2015 Taber D9/453
D778,724 S * 2/2017 Martini D9/443
D783,402 S * 4/2017 Martini D9/452

* cited by examiner

Primary Examiner — Ricky Pham

(74) *Attorney, Agent, or Firm* — Polsinelli PC

(57) **CLAIM**

The ornamental design for a stopper for beverage bottle, as shown and described.

DESCRIPTION

FIG. 1 is an upper perspective view of the stopper for beverage bottle;
FIG. 2 is a lower perspective view of the stopper for beverage bottle;
FIG. 3 is a front view of the stopper for beverage bottle;
FIG. 4 is a rear view of the stopper for beverage bottle;
FIG. 5 is a right side view of the stopper for beverage bottle;
FIG. 6 is a left side view of the stopper for beverage bottle;
FIG. 7 is a top view of the stopper for beverage bottle; and,
FIG. 8 is a bottom view of the stopper for beverage bottle.
The broken lines showing in the figures are included for the purpose of illustrating portions of the stopper for beverage bottle that form no part of the claimed design.

1 Claim, 4 Drawing Sheets

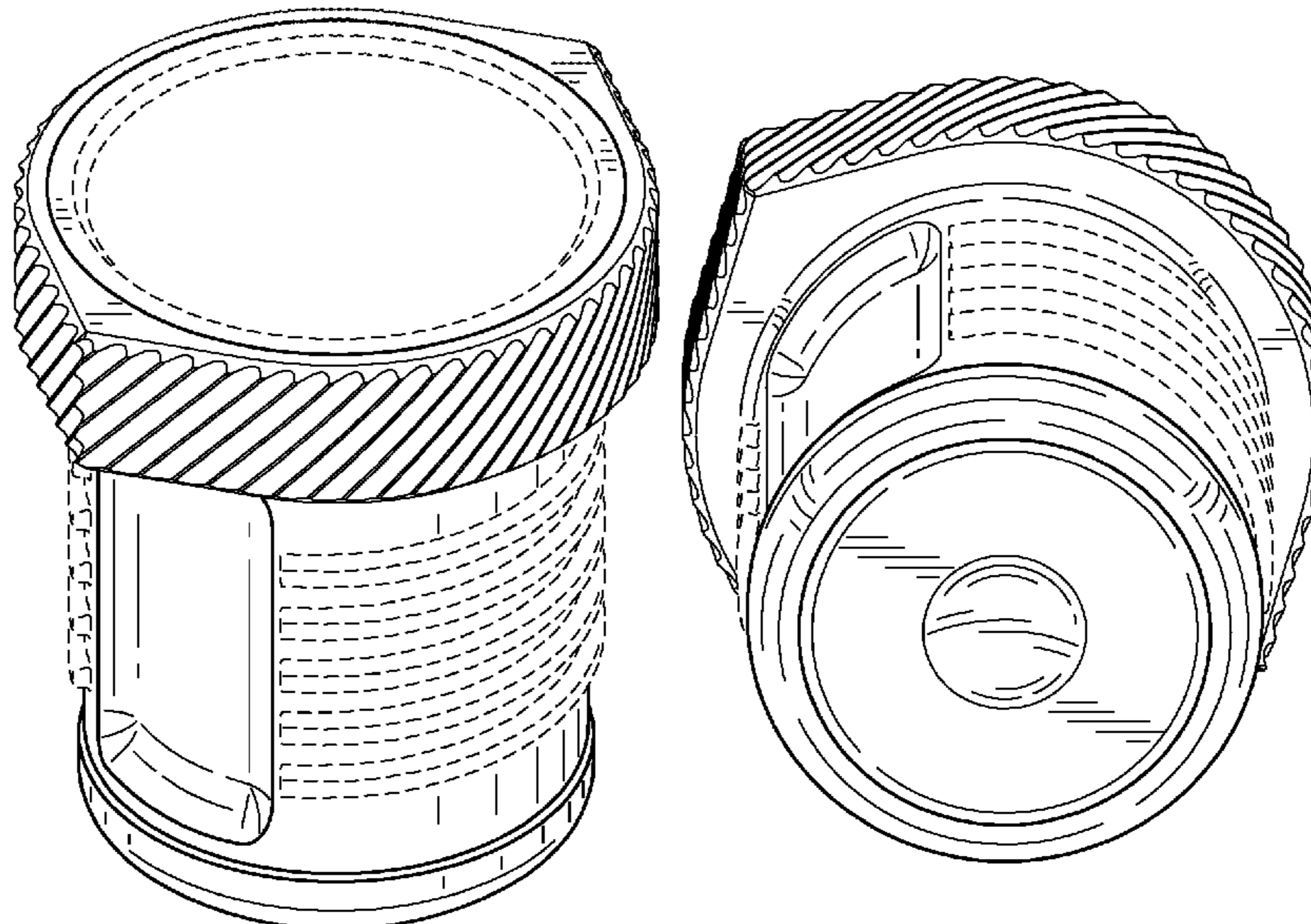

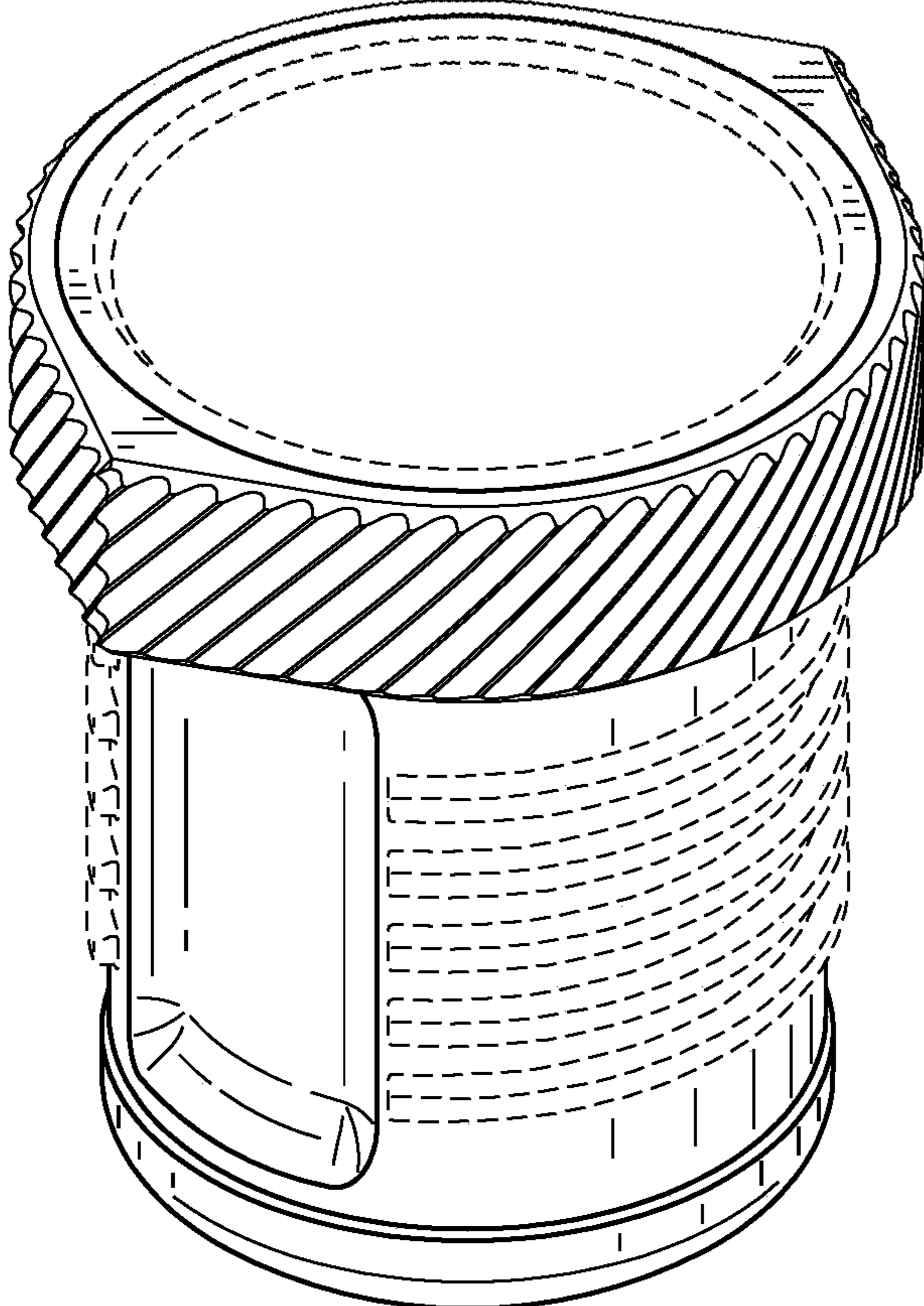

FIG. 1

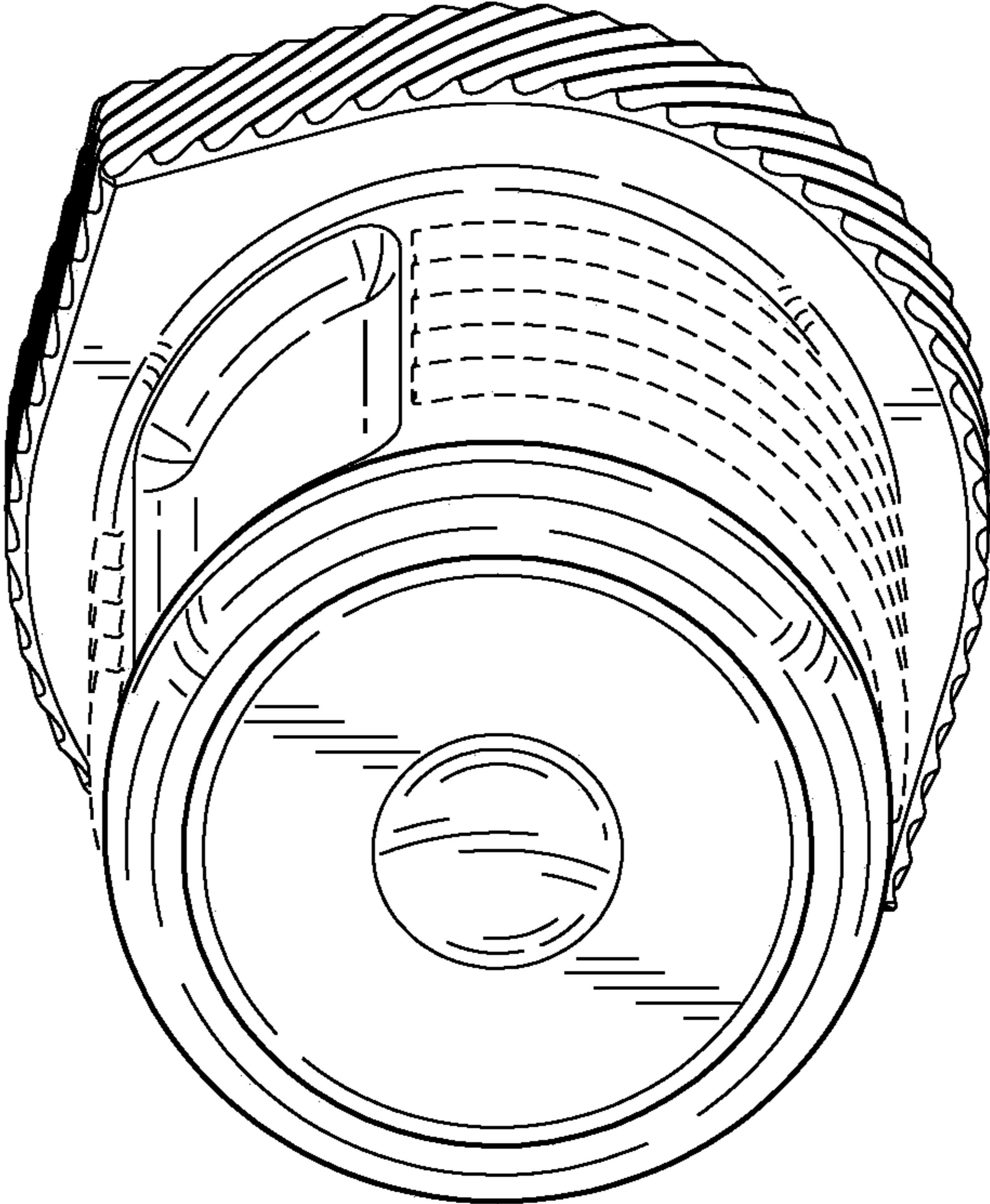

FIG. 2

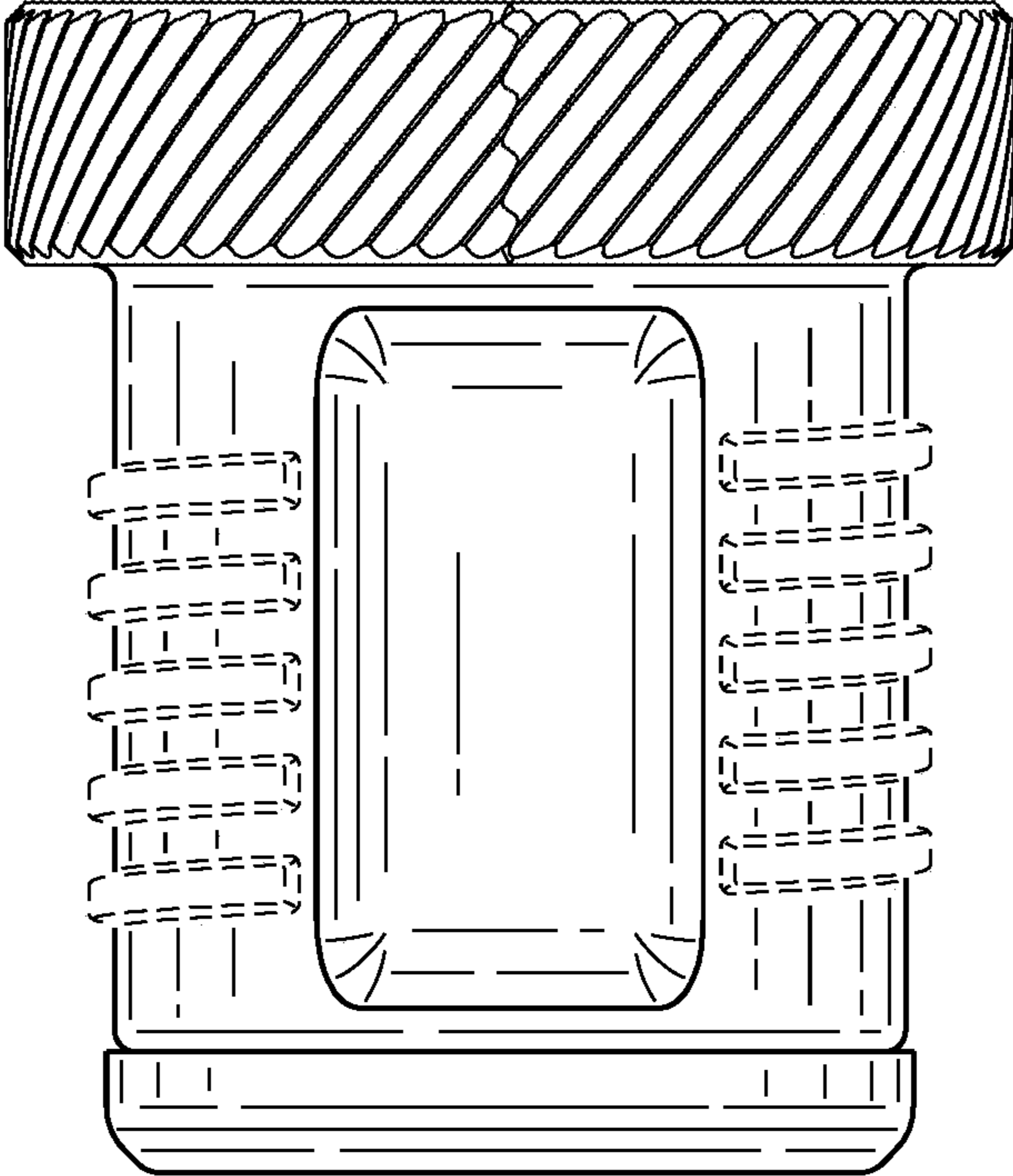

FIG. 3

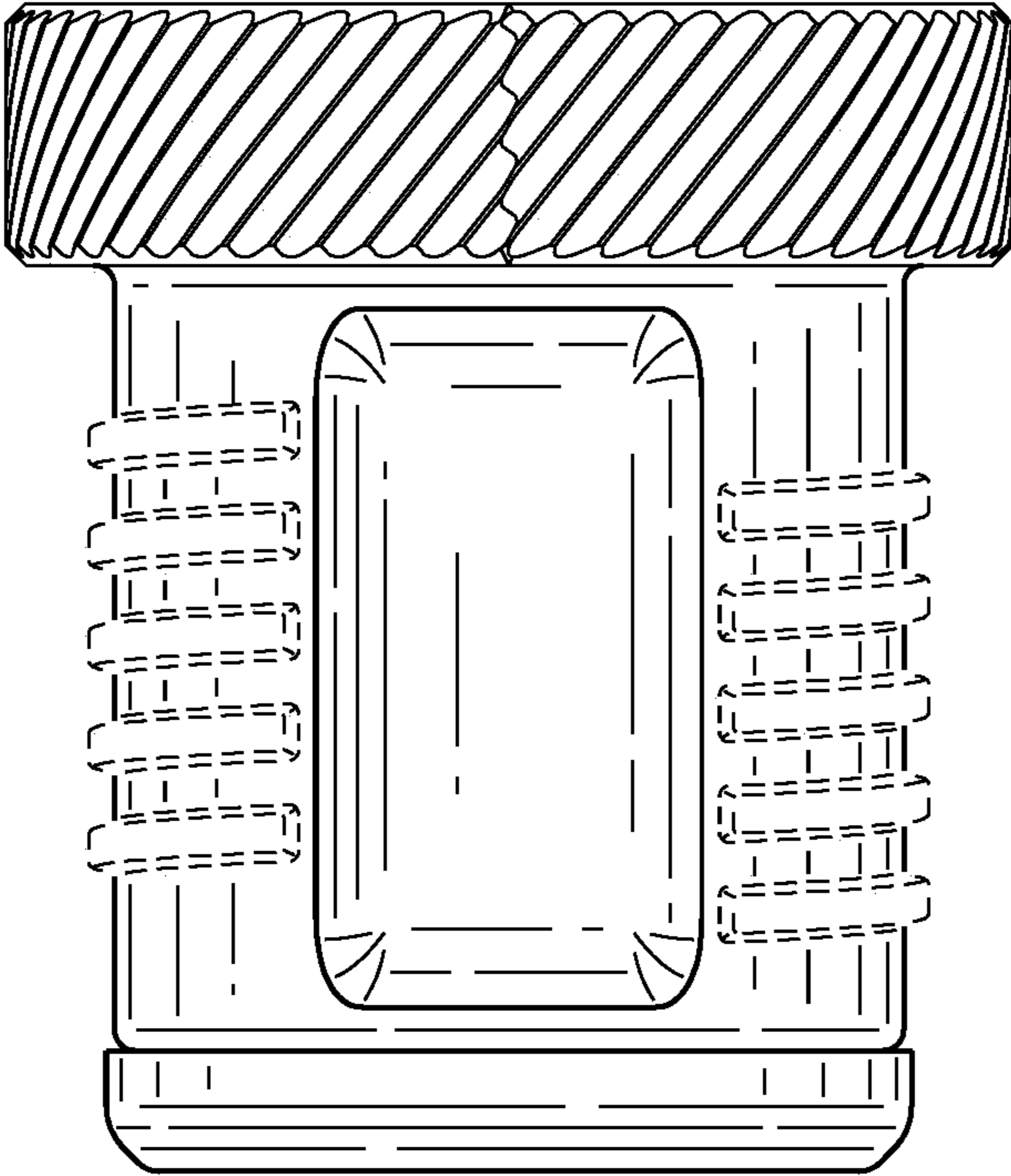

FIG. 4

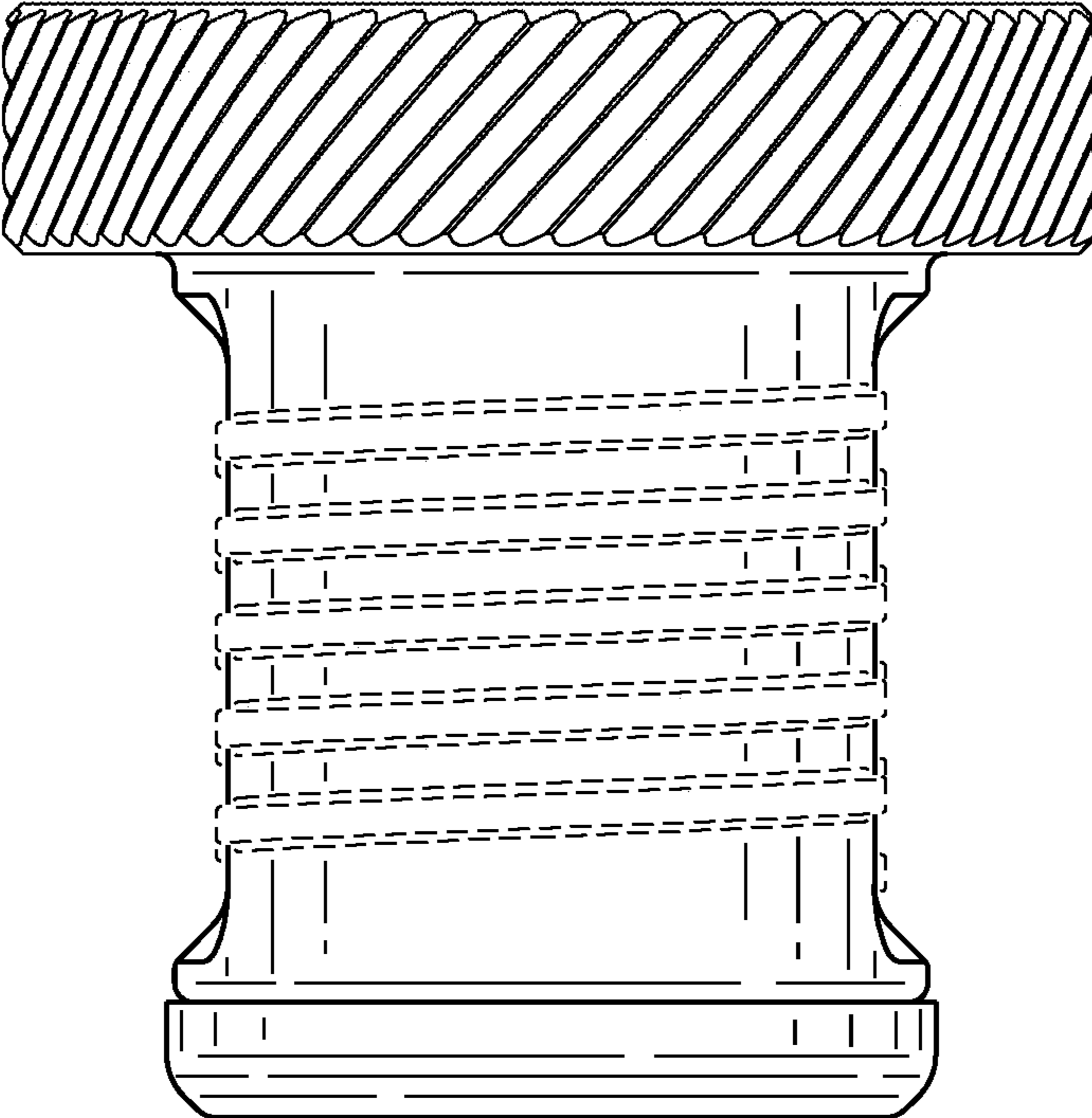

FIG. 5

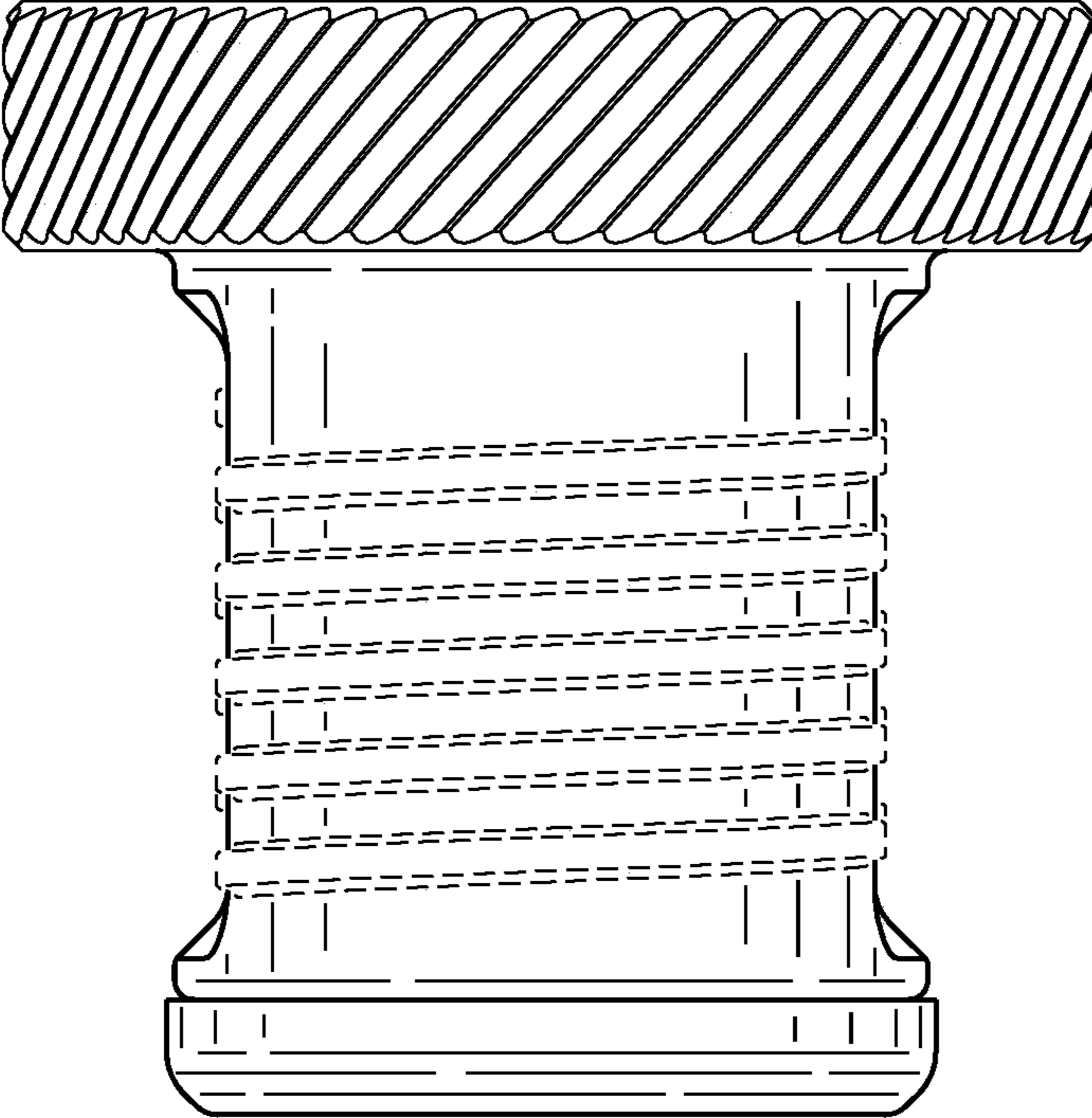

FIG. 6

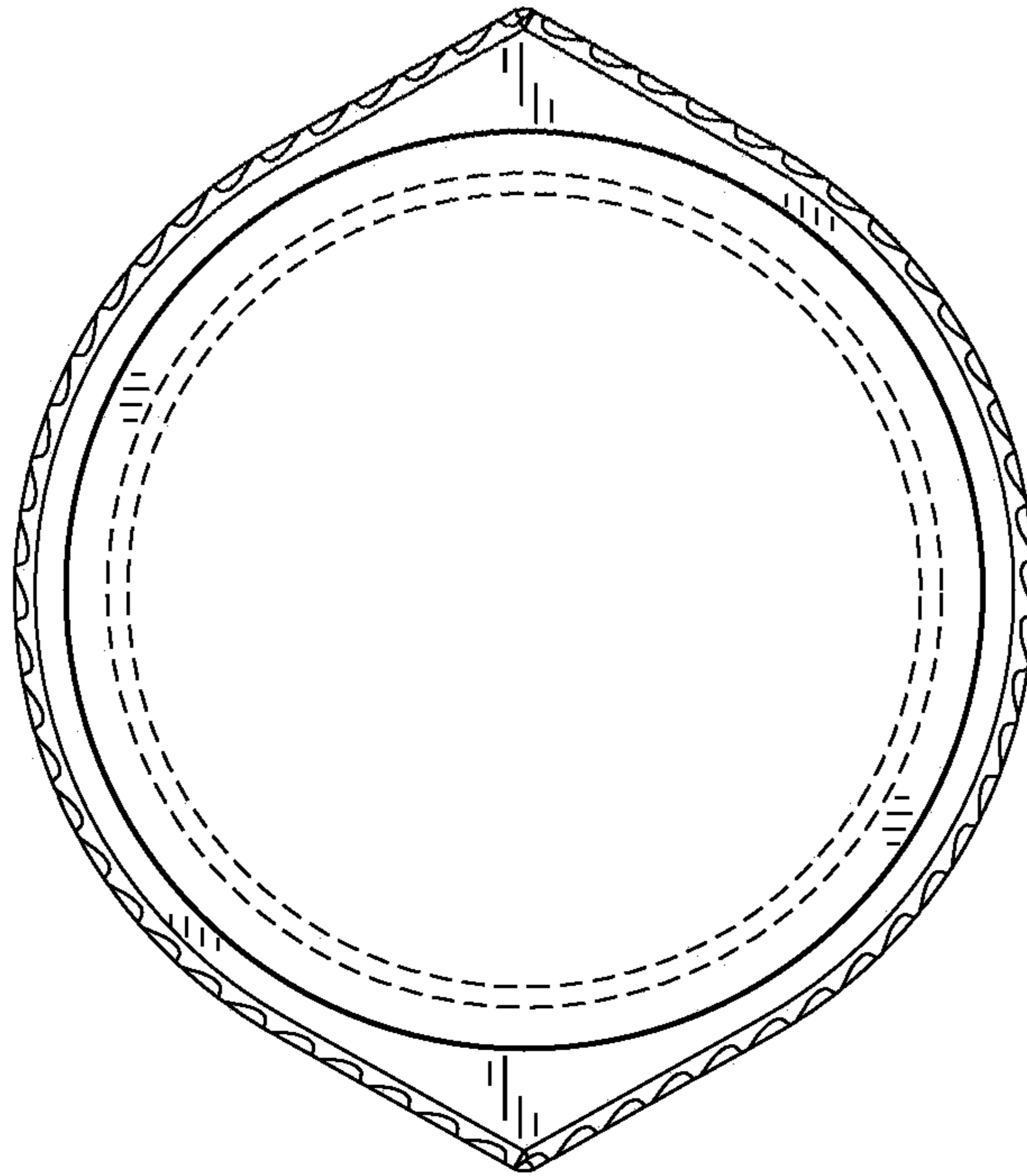

FIG. 7

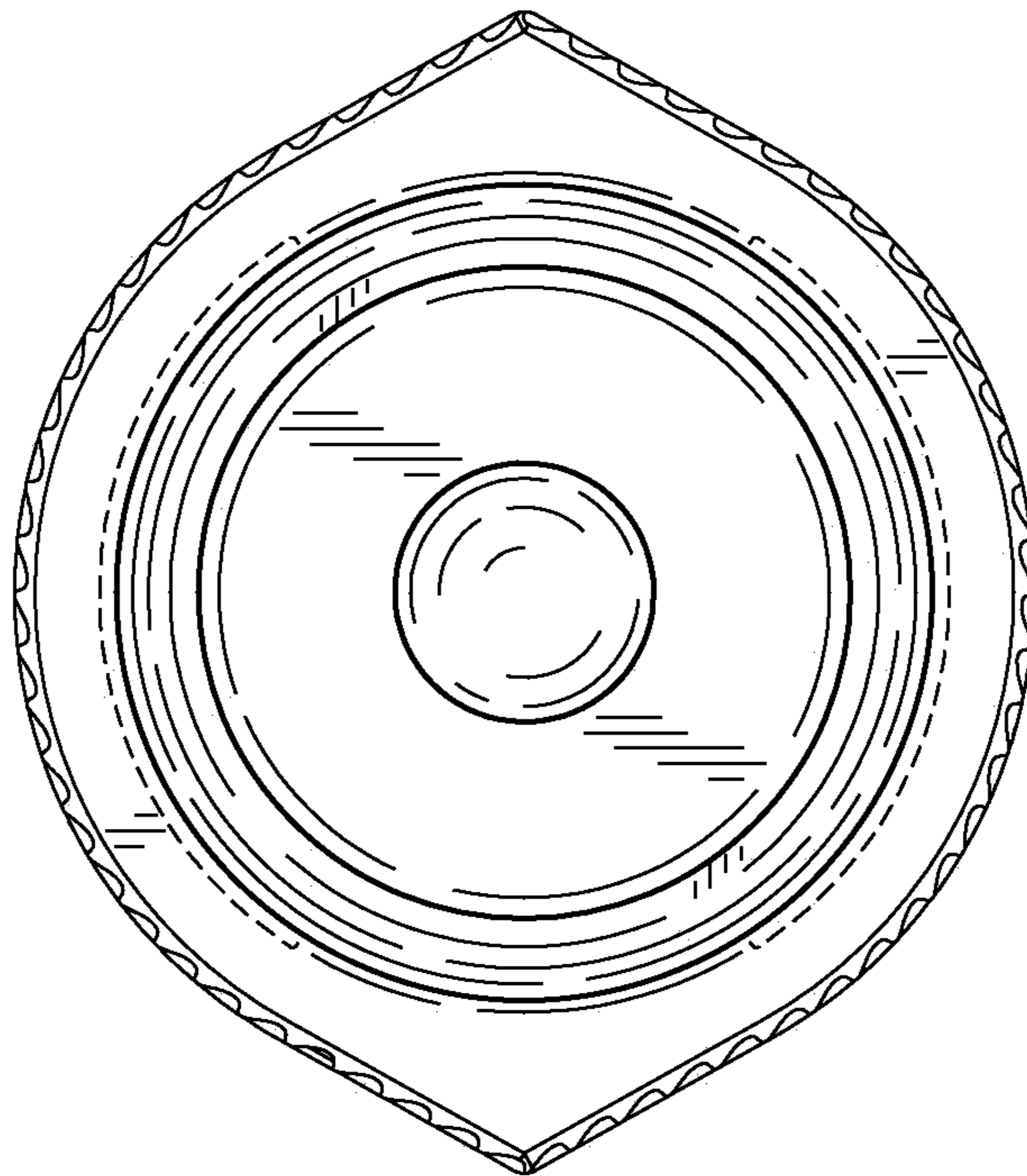

FIG. 8