



US00D902620S

(12) **United States Design Patent** (10) **Patent No.:** **US D902,620 S**
Roche (45) **Date of Patent:** **** Nov. 24, 2020**

(54) **SHEET PRODUCT DISPENSER**

(56) **References Cited**

(71) Applicant: **GPCP IP HOLDINGS LLC**, Atlanta, GA (US)

U.S. PATENT DOCUMENTS

(72) Inventor: **Nathan Patrick Roche**, Atlanta, GA (US)

D156,646 S 6/1948 Mell
2,840,319 A 5/1956 Danko
(Continued)

(73) Assignee: **GPCP IP HOLDINGS LLC**, Atlanta, GA (US)

OTHER PUBLICATIONS

(**) Term: **15 Years**

Compact Bath Tissue and Dispensers-Brands-Georgia-Pacific Professional [online][retrieved Dec. 14, 2015]. Retrieved from the Internet: <URL: https://www.gppro.com/brand_compact.aspx>. 3 pages.

(21) Appl. No.: **29/685,235**

(Continued)

(22) Filed: **Mar. 27, 2019**

Primary Examiner — Wan Laymon
Assistant Examiner — Mark Booker
(74) *Attorney, Agent, or Firm* — Nelson Mullins Riley & Scarborough LLP

Related U.S. Application Data

(63) Continuation of application No. 29/604,055, filed on May 15, 2017, now Pat. No. Des. 850,145.

(51) **LOC (12) Cl.** **20-02**

(57) **CLAIM**

(52) **U.S. Cl.**
USPC **D6/520**

The ornamental design for a sheet product dispenser, as shown and described.

(58) **Field of Classification Search**

DESCRIPTION

USPC D6/515, 516, 517, 518, 519–523;
D7/550.1, 609, 610, 611, 612, 325, 348,
D7/350.1, 350.2, 367; 206/389;
242/570, 590, 595, 596, 598, 598.5,
242/598.6, 564.2; 312/34.1, 34.8;
700/232
CPC A47K 10/3836; A47K 10/38; A47K
2010/3863; A47K 2010/3253; A47K
10/36; A47K 10/40; A47K 10/22; A47K
10/32; A47K 10/34; A47K 10/3687;
A47K 10/3827; A47K 10/3818; A47K
10/405; A47K 2010/3246; A47K
2010/326; A47F 5/0823; A47F 5/0861;
A47F 5/0006; A47F 5/0807; A47F
7/0028; A47F 5/0869; A47F

FIG. 1 is a perspective view of a sheet product dispenser in accordance with the present invention;
FIG. 2 is a front view of the sheet product dispenser of FIG. 1;
FIG. 3 is a rear view of the sheet product dispenser of FIG. 1;
FIG. 4 is a right side view of the sheet product dispenser of FIG. 1;
FIG. 5 is a left side view of the sheet product dispenser of FIG. 1;
FIG. 6 is a top view of the sheet product dispenser of FIG. 1; and,
FIG. 7 is a bottom view of the sheet product dispenser of FIG. 1.

(Continued)

(Continued)

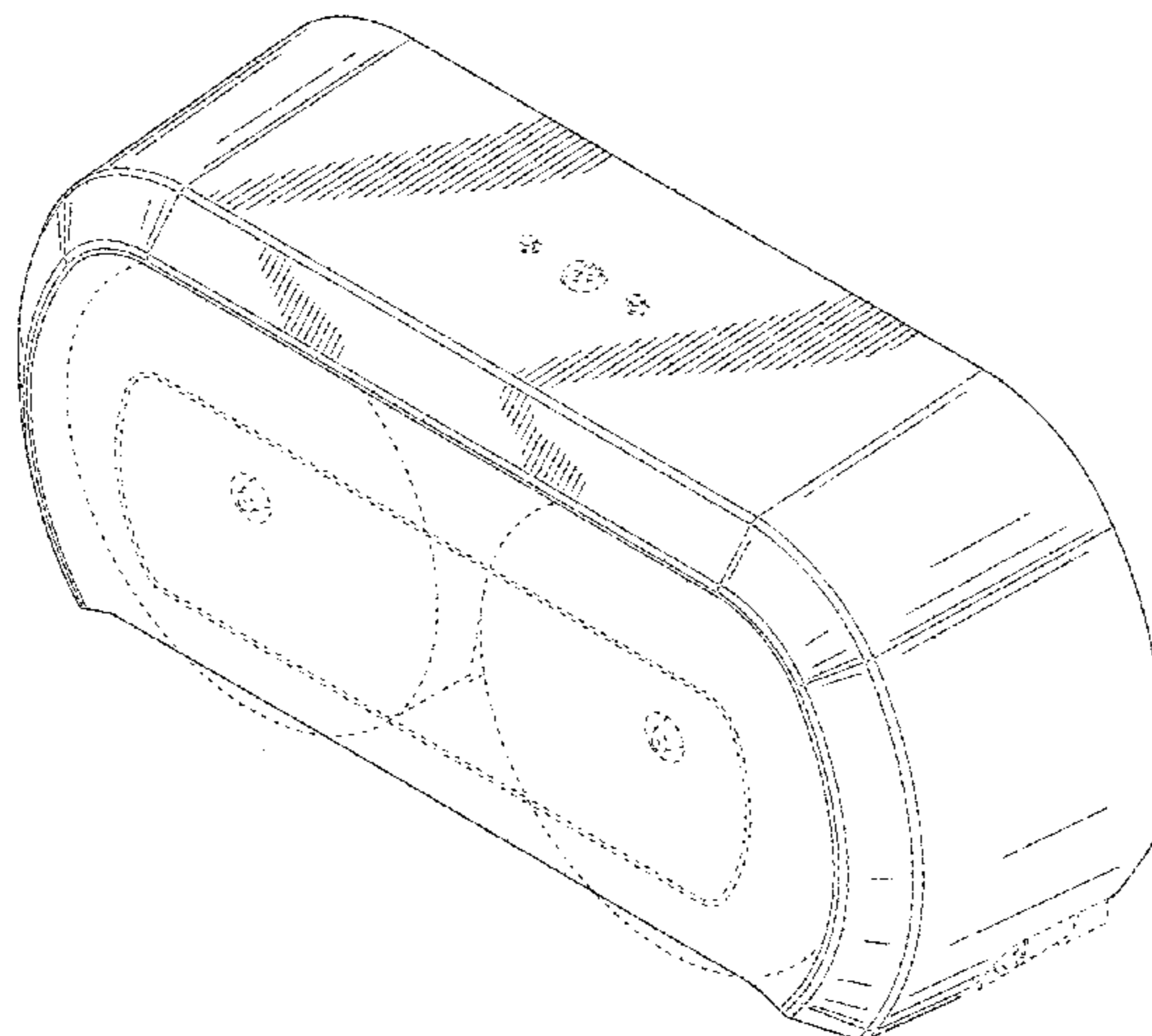

The broken lines are included for the purpose of illustrating unclaimed features of the sheet product dispenser and form no part of the claimed design.

1 Claim, 6 Drawing Sheets

(58) Field of Classification Search

CPC . 7/00; A47F 7/163; A47F 5/01; A47F 5/0815; A47F 5/0838; A47F 5/103; A47F 7/065; A47F 1/128; A47F 5/0018; A47F 5/04
See application file for complete search history.

(56) References Cited

U.S. PATENT DOCUMENTS

D212,010	S	8/1968	Tucker	
4,872,601	A	10/1989	Sigmund	
D307,845	S	5/1990	Omdoll et al.	
D310,922	S	10/1990	Sigmund	
D312,179	S	11/1990	De Luca et al.	
D335,410	S	5/1993	Abel et al.	
5,265,816	A	11/1993	Collins	
D351,520	S	10/1994	Frazier et al.	
D358,516	S	5/1995	Chen	
D373,276	S *	9/1996	Omdoll	D6/520
5,636,812	A	6/1997	Conner et al.	
5,813,624	A	9/1998	Grasso et al.	
5,954,256	A	9/1999	Niada	
6,056,233	A	5/2000	Von Schenk	
D441,228	S	5/2001	Andersson	
D443,778	S	6/2001	Andersson	
6,364,245	B1	4/2002	Paal et al.	
6,758,434	B2	7/2004	Kapiloff et al.	
D543,402	S	5/2007	Goeking et al.	
7,219,852	B2	5/2007	Tramontina et al.	
D543,745	S	6/2007	Goeking et al.	
D547,581	S	7/2007	Cittadino et al.	
D551,474	S	9/2007	Cittadino et al.	
D556,482	S	12/2007	Goeking et al.	
D572,058	S	7/2008	Cittadino et al.	
D605,444	S	12/2009	Marietta-Tondin	
7,648,097	B2	1/2010	Cattacin et al.	
D613,537	S	4/2010	Pattberg	
D613,538	S *	4/2010	Cattacin	D6/523
D623,452	S	9/2010	McNeely et al.	
D654,740	S	2/2012	Cheng et al.	
D667,661	S	9/2012	Norton	
D668,485	S	10/2012	Velazquez et al.	
D695,542	S	12/2013	Niada	
D719,373	S	12/2014	Hawry et al.	
8,991,647	B2	3/2015	Meyers	

D727,058	S	4/2015	Morand	
D756,683	S	5/2016	Morand	
D761,585	S	7/2016	Roche et al.	
D766,612	S	9/2016	Roche et al.	
D782,842	S	4/2017	Morand et al.	
D790,872	S	7/2017	Ku et al.	
D818,737	S	5/2018	Cross	
D818,738	S	5/2018	Cross	
D850,145	S *	6/2019	Roche	D6/520
2002/0050544	A1	5/2002	Stanland et al.	
2006/0102770	A1	5/2006	Goeking et al.	
2007/0290094	A1	12/2007	Anderson	
2008/0128448	A1	6/2008	Cittadino et al.	
2008/0156926	A1	7/2008	Cattacin et al.	
2009/0212150	A1 *	8/2009	Wruck, Jr.	A47K 10/36 242/564.2
2010/0286818	A1 *	11/2010	Goeking	A47K 10/3625 700/232
2014/0103133	A1	4/2014	Muderlak et al.	
2018/0153359	A1 *	6/2018	Ziebart	A47K 10/38

OTHER PUBLICATIONS

Compact® Coreless Bathroom Tissue & Dispensers [online][retrieved Dec. 14, 2015]. Retrieved from the Internet: <URL: <https://www.catalog.gppro.com/catalog/6281>>. 8 pages.

Dispenser [online] [retrieved Apr. 12, 2017]. Retrieved from the Internet: <URL: <http://www.mepsol.com.br/images/dispenser01.png>>. (undated) 1 page.

Georgia pacific tissue dispenser—Google Search [online][retrieved Mar. 9, 2016]. Retrieved from the Internet: <URL: https://www.google.com/search?q=georgia+pacific+toilet+paper+dispenser&source=lnms&tbm=isch&sa=X&ved=0ahUKEwiXyoq187PLAhUJKiYKHURwAaIQ_AUICCGC#tbm=isch&q=georgia+pacific+tissue+dispenser>. 2 pages.

Georgia pacific toilet paper dispenser—Google Search [online] [retrieved Mar. 9, 2016]. Retrieved from the Internet: <URL: https://www.google.com/search?q=georgia+pacific+toilet+paper+dispenser&source=lnms&tbm=isch&sa=X&ved=0ahUKEwiXyoq187PLAhUJKiYKHURwAaIQ_AUICCGC>. 3 pages.

Georgia-Pacific Compact 56784 Translucent Smoke Side-By-Side Double Roll Bathroom Tissue Dispenser: Toilet Paper Holders: Amazon.com [online] [retrieved Dec. 14, 2015]. Retrieved from the Internet: <URL: https://www.amazon.com/gp/product/B001B0E7M0/ref=s9_al_bw_g328_il>, 7 pages.

Linha Dispensers [online][retrieved Apr. 12, 2017]. Retrieved from the Internet: <URL: http://www.mepsol.com.br/1_dispensers.html>. (undated) 1 page.

Design U.S. Appl. No. 29/548,134, filed Dec. 10, 2015.

Design U.S. Appl. No. 29/600,286 and Preliminary Amendment filed Apr. 11, 2017.

Design U.S. Appl. No. 29/604,055, filed May 15, 2017.

* cited by examiner

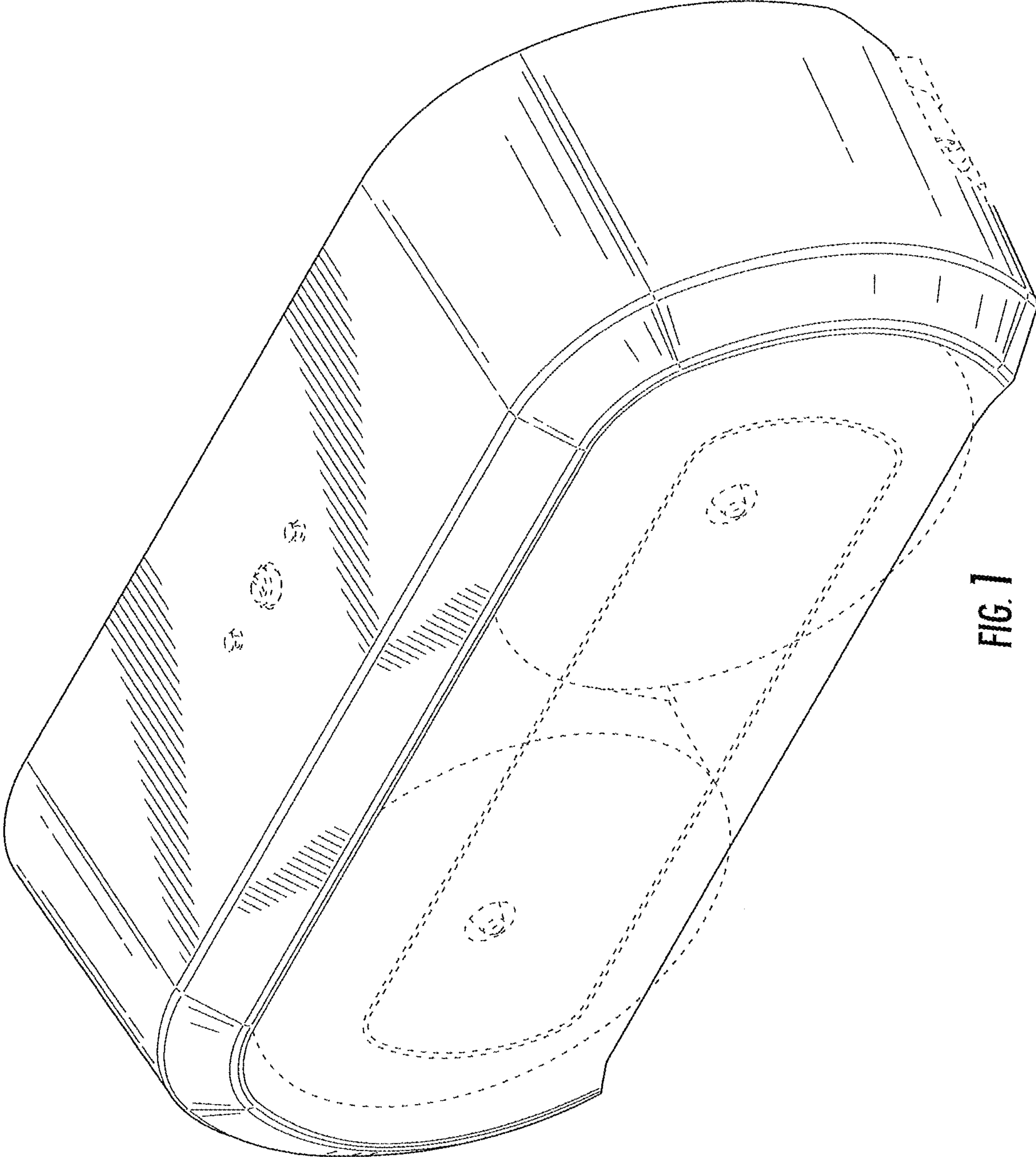

FIG. 1

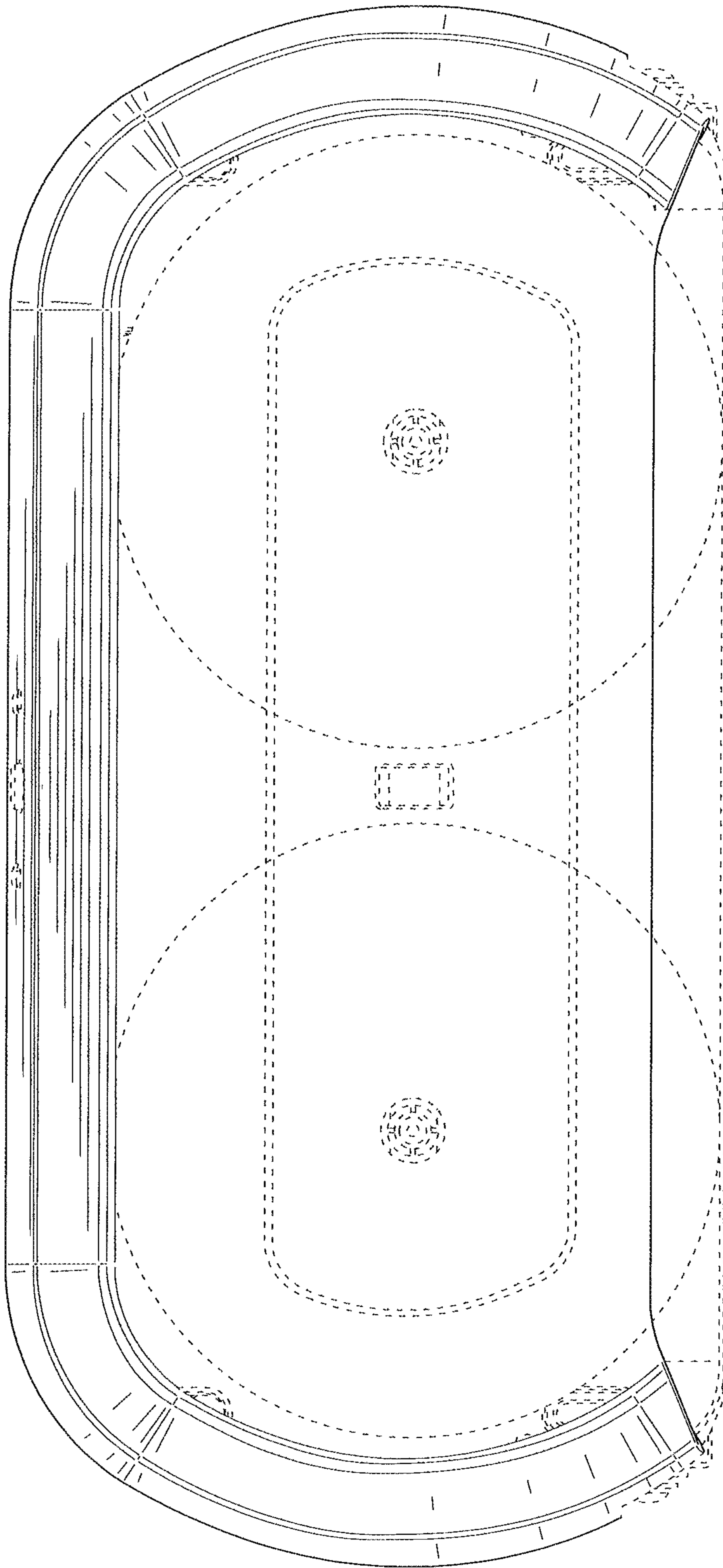

FIG. 2

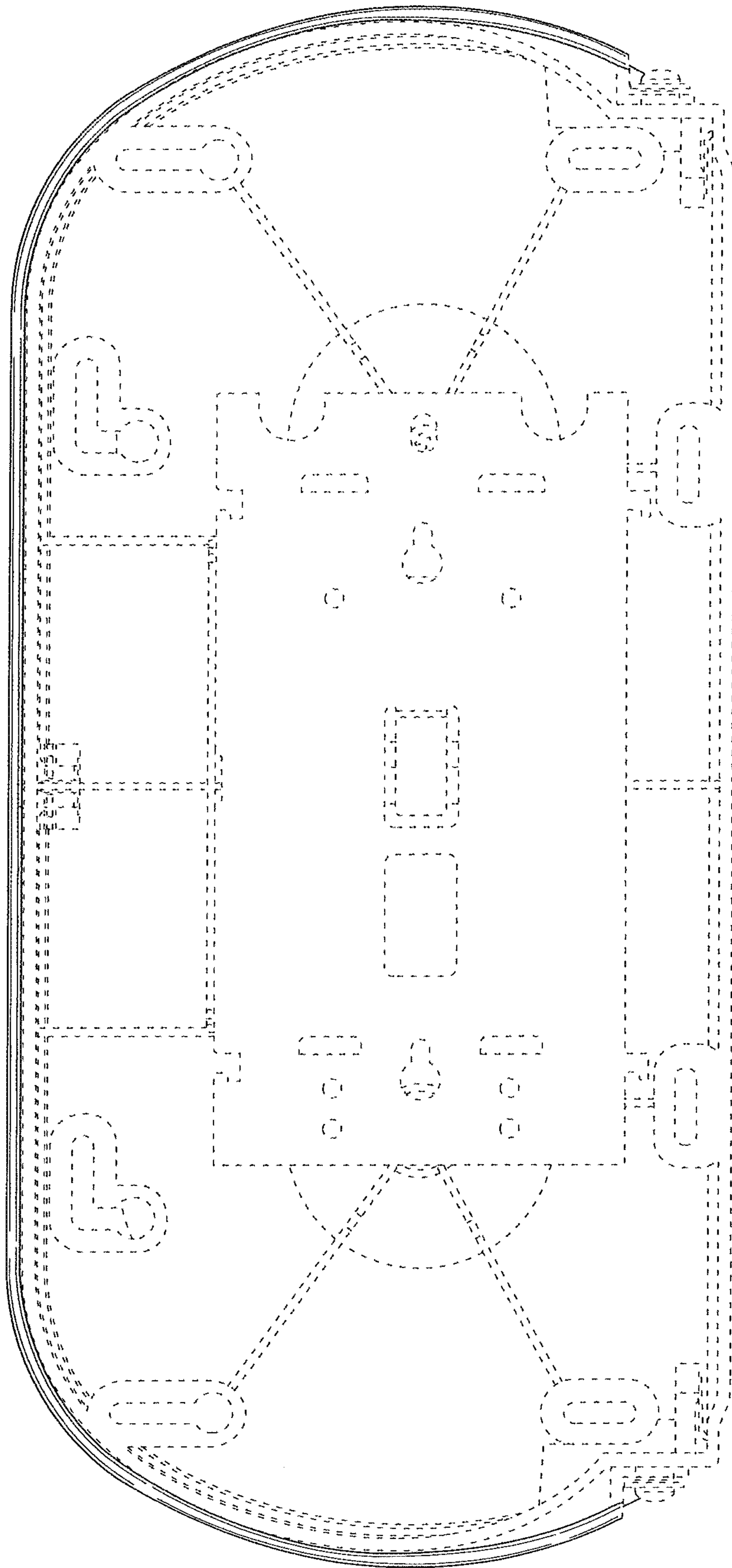

FIG. 3

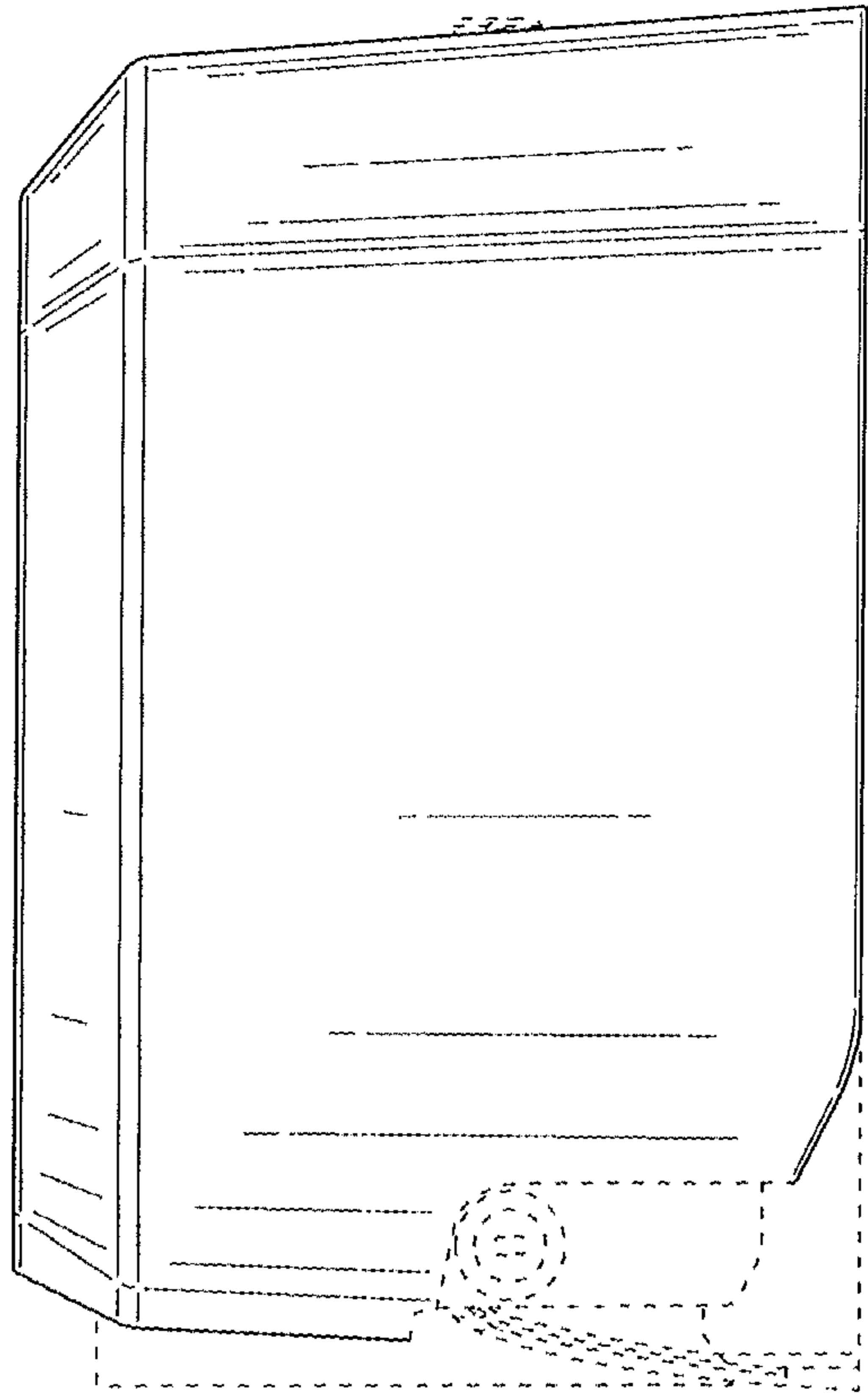

FIG. 4

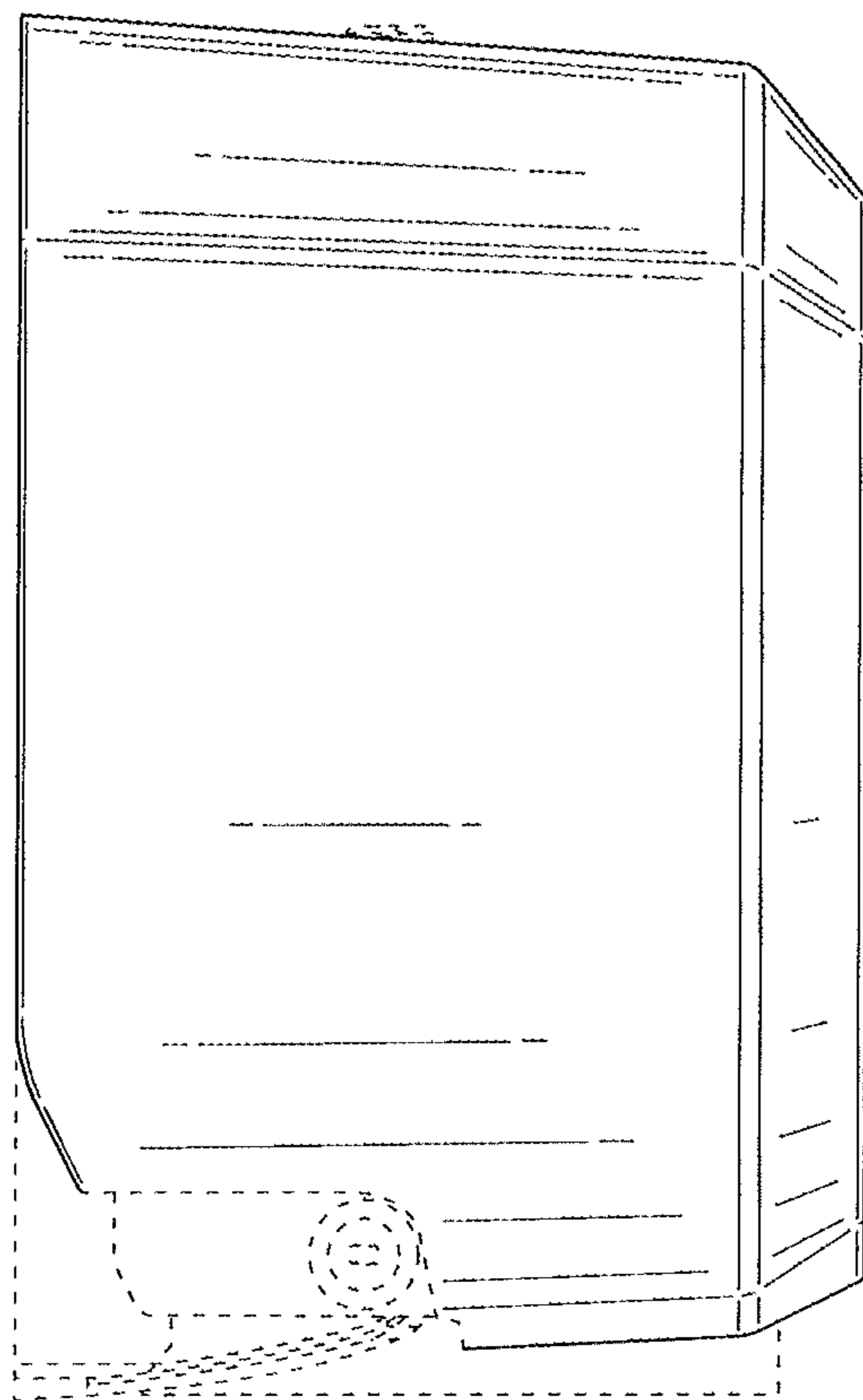

FIG. 5

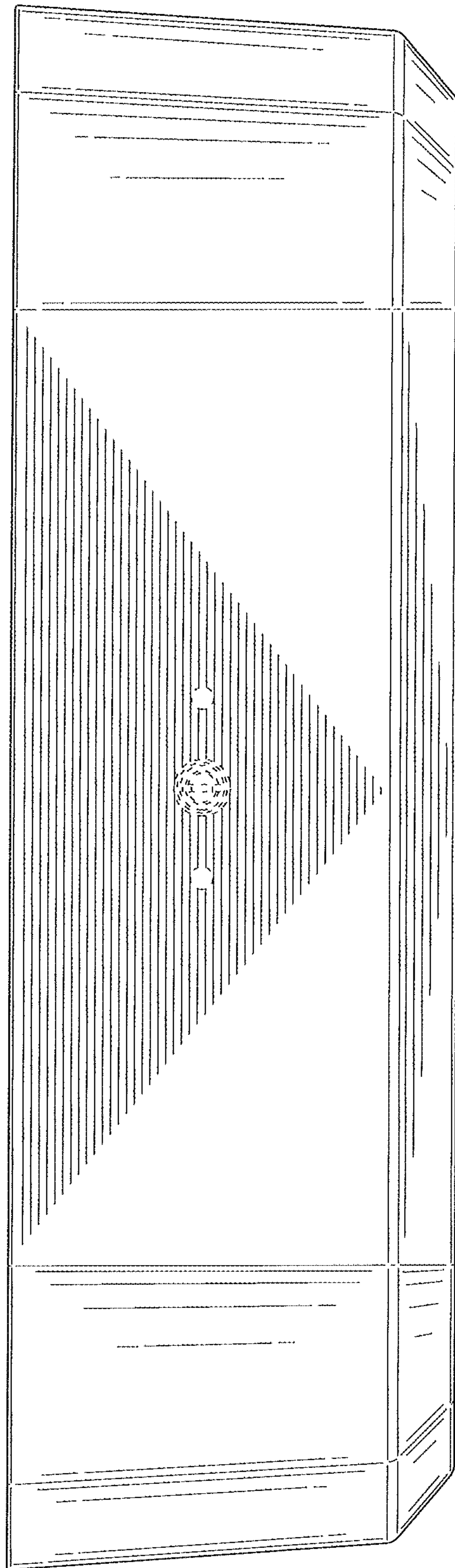

FIG. 6

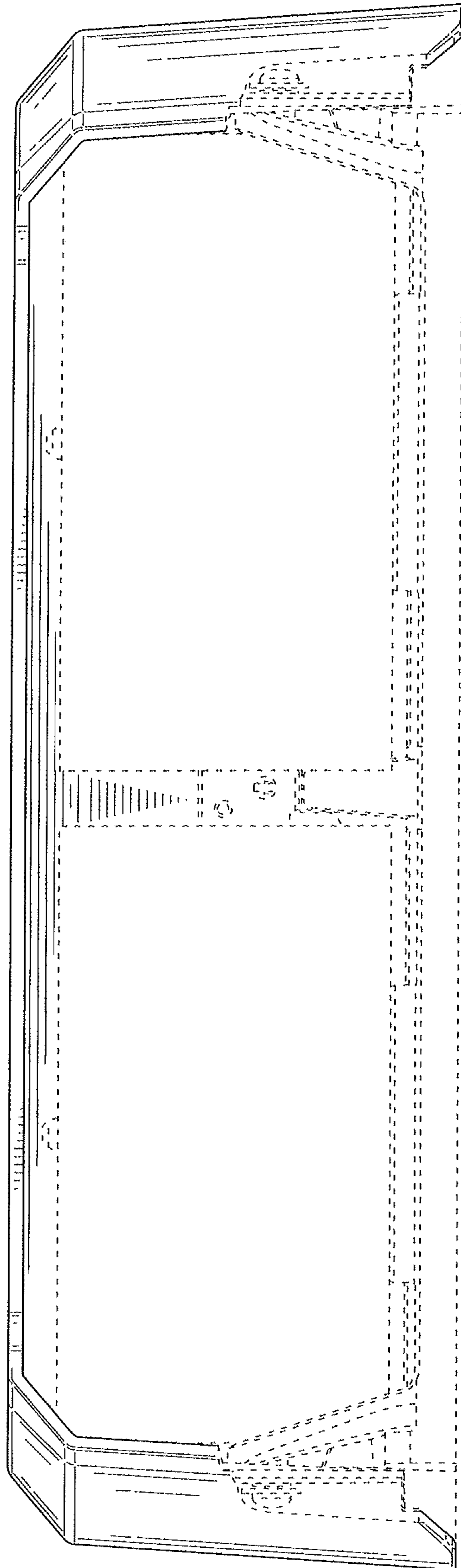

FIG. 7