



US00D902591S

(12) **United States Design Patent**
Gouttebel et al.

(10) **Patent No.:** **US D902,591 S**

(45) **Date of Patent:** **** Nov. 24, 2020**

(54) **CARRYALL**

(71) Applicant: **Cuyana, Inc.**, San Francisco, CA (US)

(72) Inventors: **Laurence Gouttebel**, San Francisco, CA (US); **Rebecca Flato**, San Francisco, CA (US)

(73) Assignee: **Cuyana, Inc.**, San Francisco, CA (US)

(**) Term: **15 Years**

(21) Appl. No.: **29/725,440**

(22) Filed: **Feb. 25, 2020**

(51) **LOC (12) Cl.** **03-01**

(52) **U.S. Cl.**
USPC **D3/303**

(58) **Field of Classification Search**
USPC D3/201, 205, 242, 273, 274, 275, 276,
D3/279, 281, 282, 283, 284, 289, 292,
D3/294, 295, 296, 297, 299, 301, 302,
D3/901, 903, 905
CPC A45C 5/04; A45C 11/00; A45C 11/16
See application file for complete search history.

(56) **References Cited**

U.S. PATENT DOCUMENTS

2,175,327	A	10/1939	Thornhill et al.	
D266,201	S *	9/1982	Berman	224/240
D279,233	S *	6/1985	Feingold	D6/629
D314,587	S	2/1991	Young	
D646,892	S *	10/2011	Littleton	D3/299
D660,592	S *	5/2012	Mecchella	D3/299
D691,805	S	10/2013	Chang	
D692,237	S	10/2013	Chang	
D872,481	S *	1/2020	Brundage	D3/303

FOREIGN PATENT DOCUMENTS

DE	9115818	U1	5/1992
KR	200463950	Y1	12/2012

* cited by examiner

Primary Examiner — Holly E Thurman

(74) *Attorney, Agent, or Firm* — Barnes & Thornburg LLP

(57) **CLAIM**

The ornamental design for a carryall, as shown and described.

DESCRIPTION

FIG. 1 is a front perspective view of the carryall design in a closed position;
 FIG. 2 is a front view of the carryall design in the closed position;
 FIG. 3 is a rear view of the carryall design in the closed position;
 FIG. 4 is a right-side view of the carryall design in the closed position;
 FIG. 5 is a left-side view of the carryall design in the closed position;
 FIG. 6 is a top view of the carryall design in the closed position;
 FIG. 7 is a bottom view of the carryall design in the closed position;
 FIG. 8 is a front perspective view of the carryall design of FIG. 1 in an open position;
 FIG. 9 is a front view of the carryall design in the open position;
 FIG. 10 is a rear view of the carryall design in the open position;
 FIG. 11 is a right-side view of the carryall design in the open position;
 FIG. 12 is a left-side view of the carryall design in the open position;
 FIG. 13 is a top view of the carryall design in the open position; and,
 FIG. 14 is a bottom view of the carryall design in the open position.

The broken lines show stitching and a zipper and represent unclaimed subject matter and form no part of the claim.

1 Claim, 10 Drawing Sheets

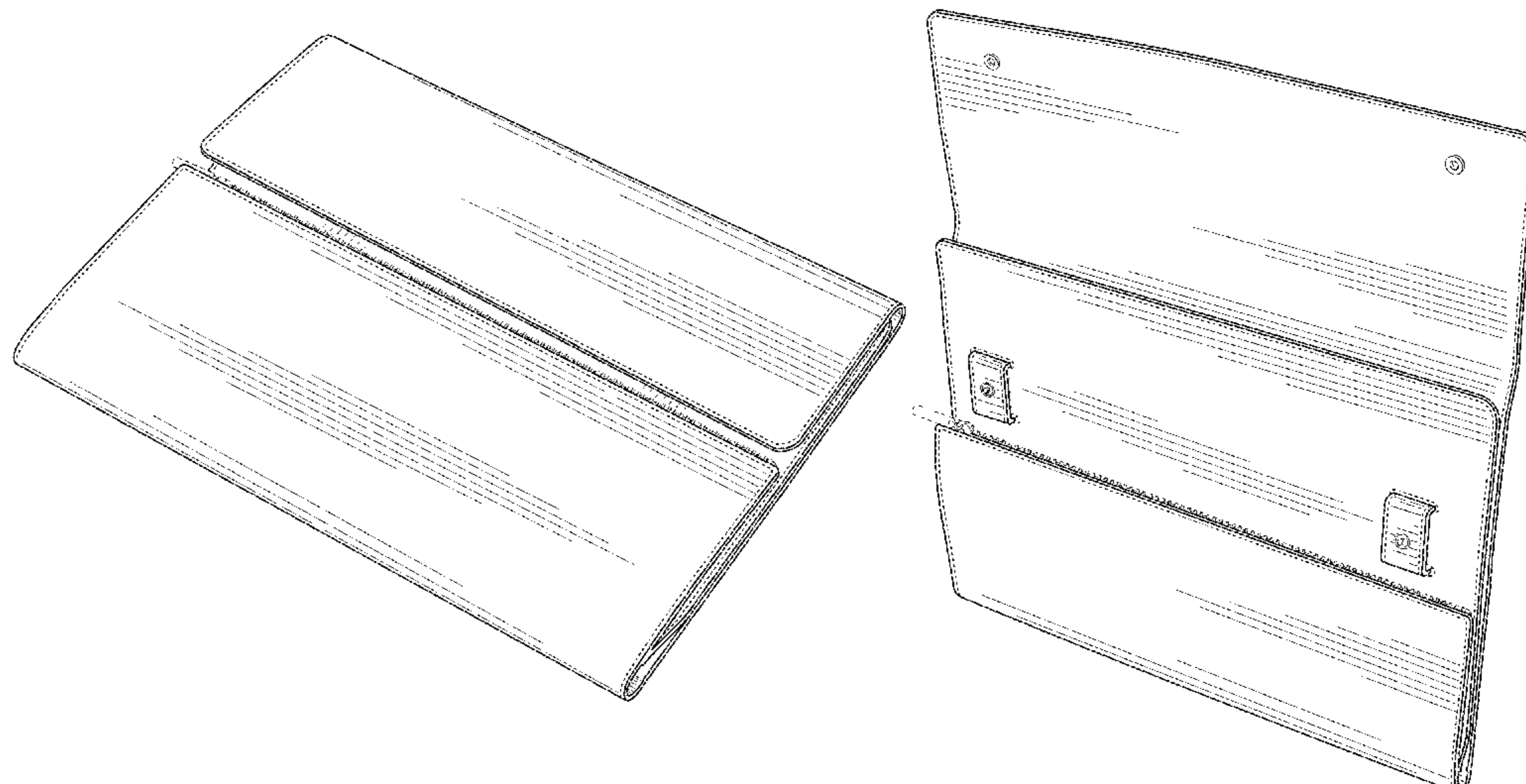

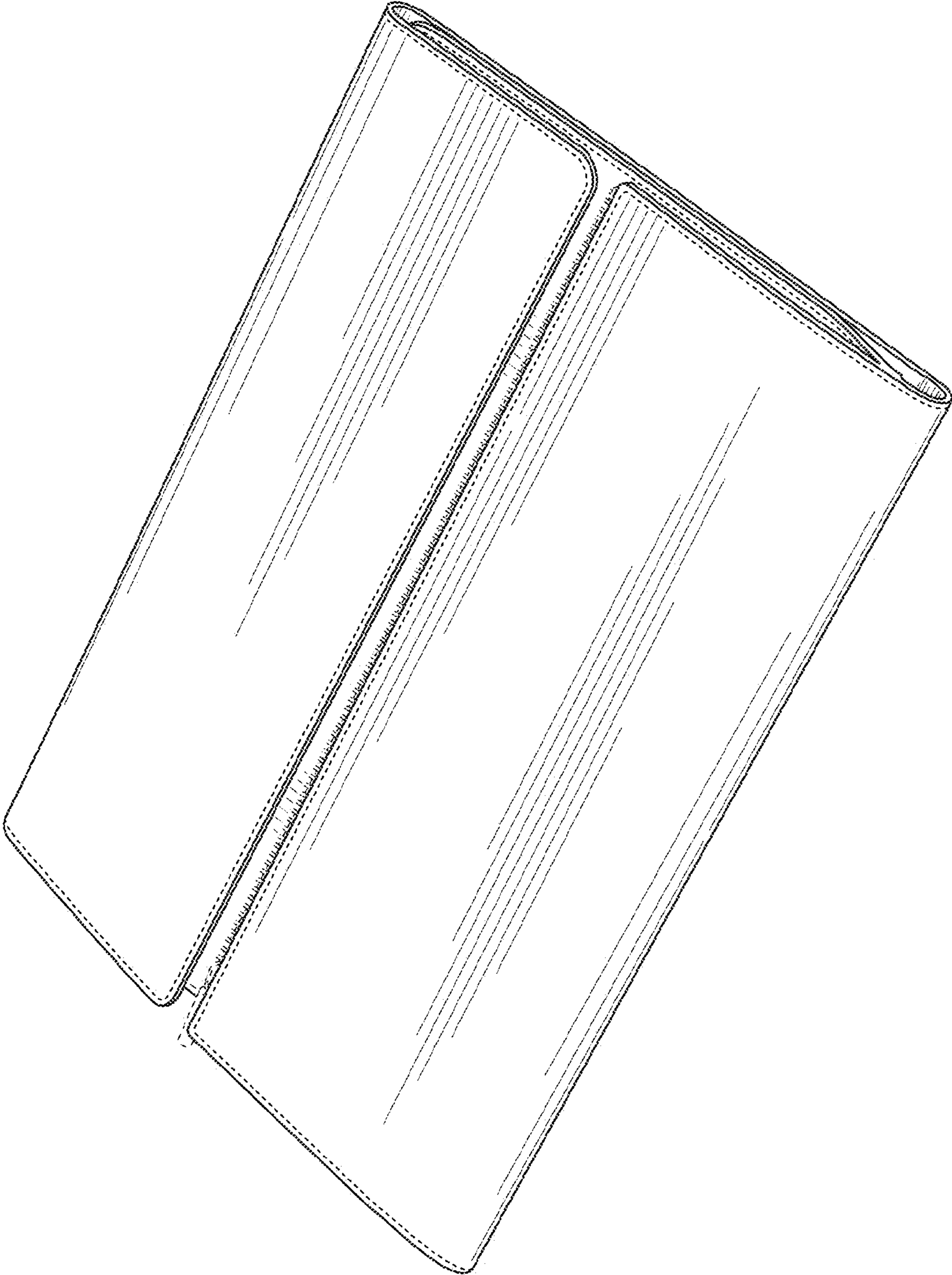

FIG. 1

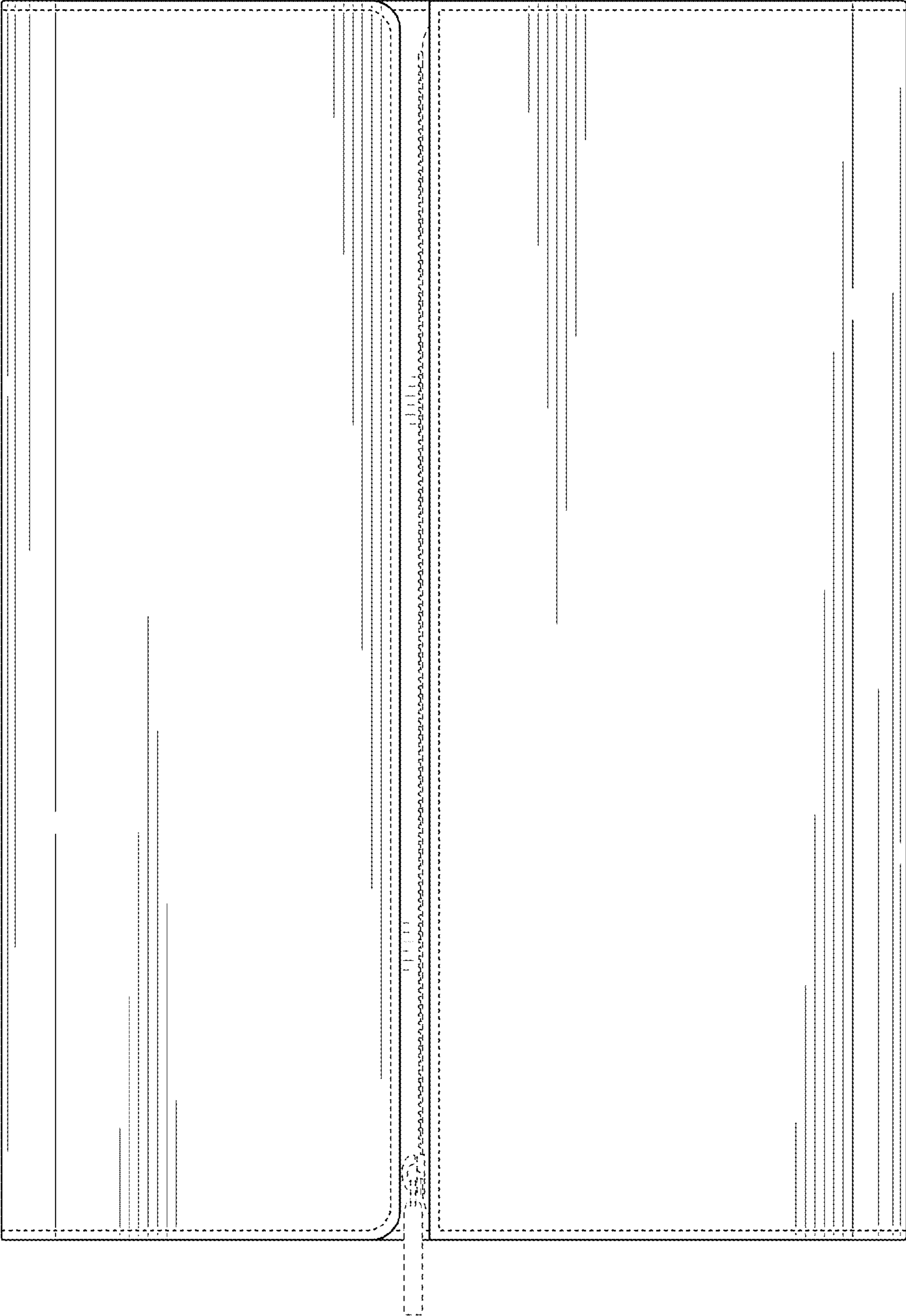

FIG. 2

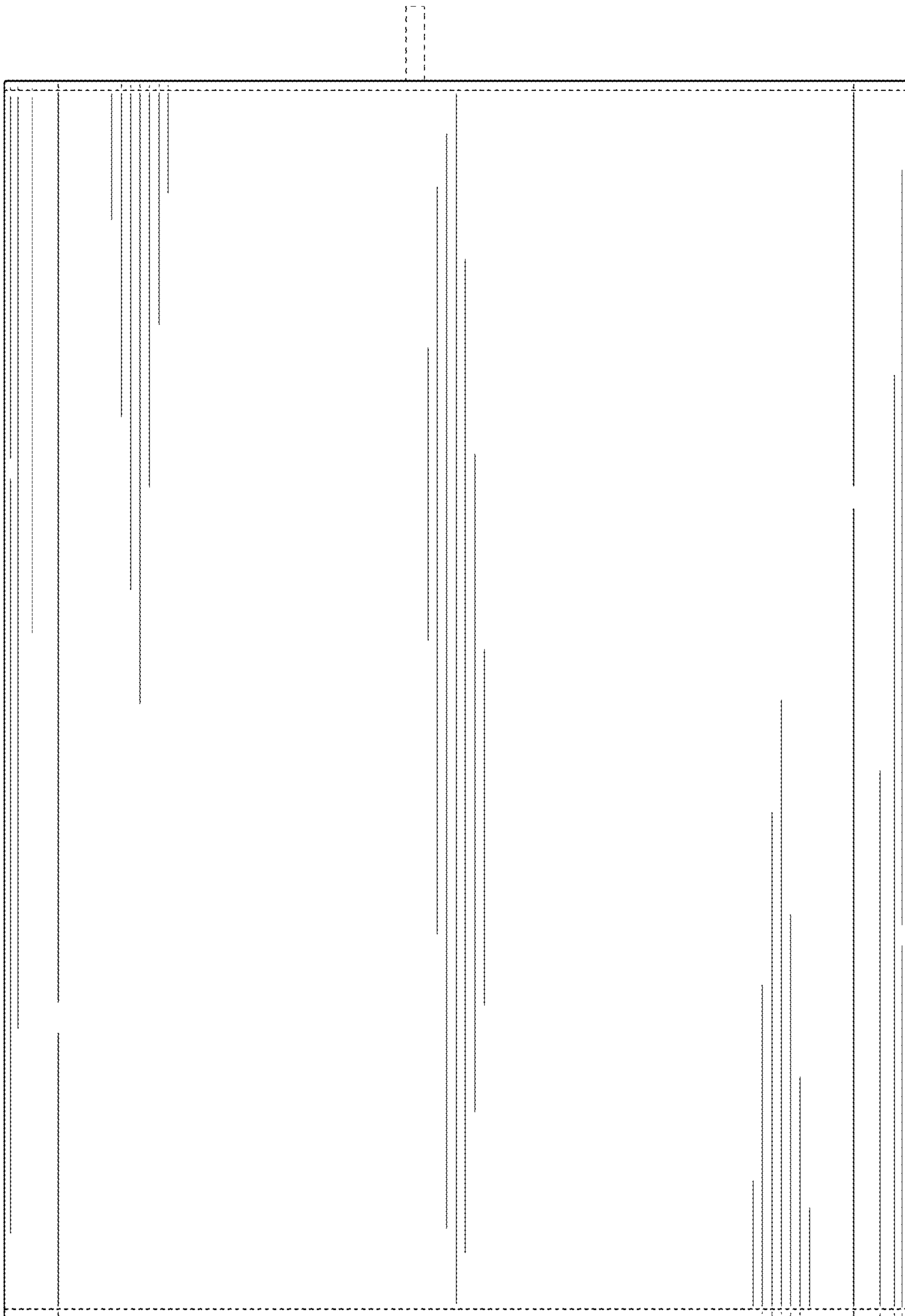

FIG. 3

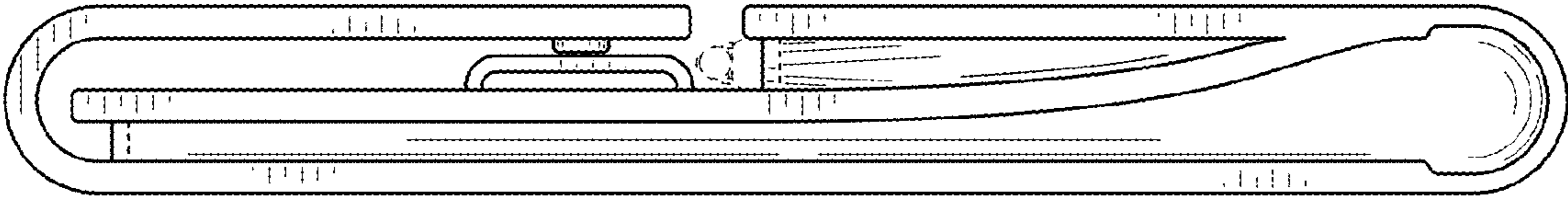

FIG. 5

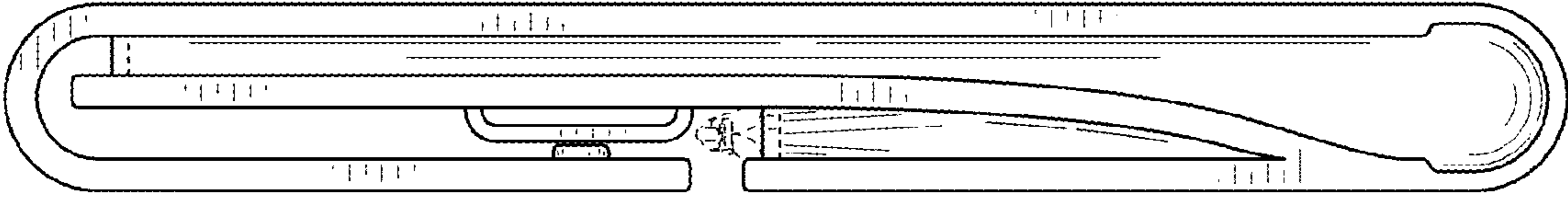

FIG. 4

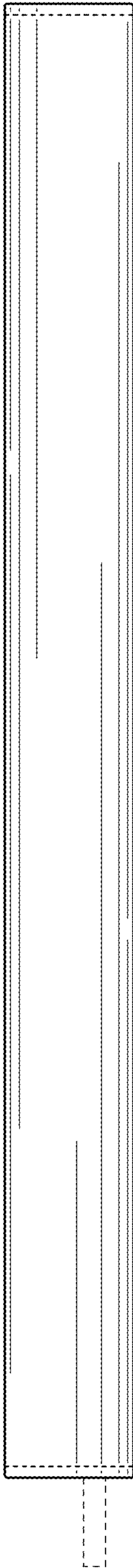

FIG. 6

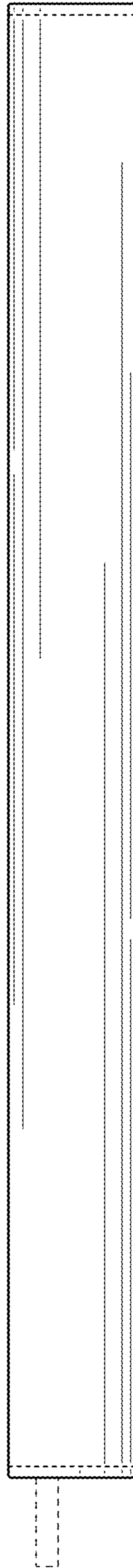

FIG. 7

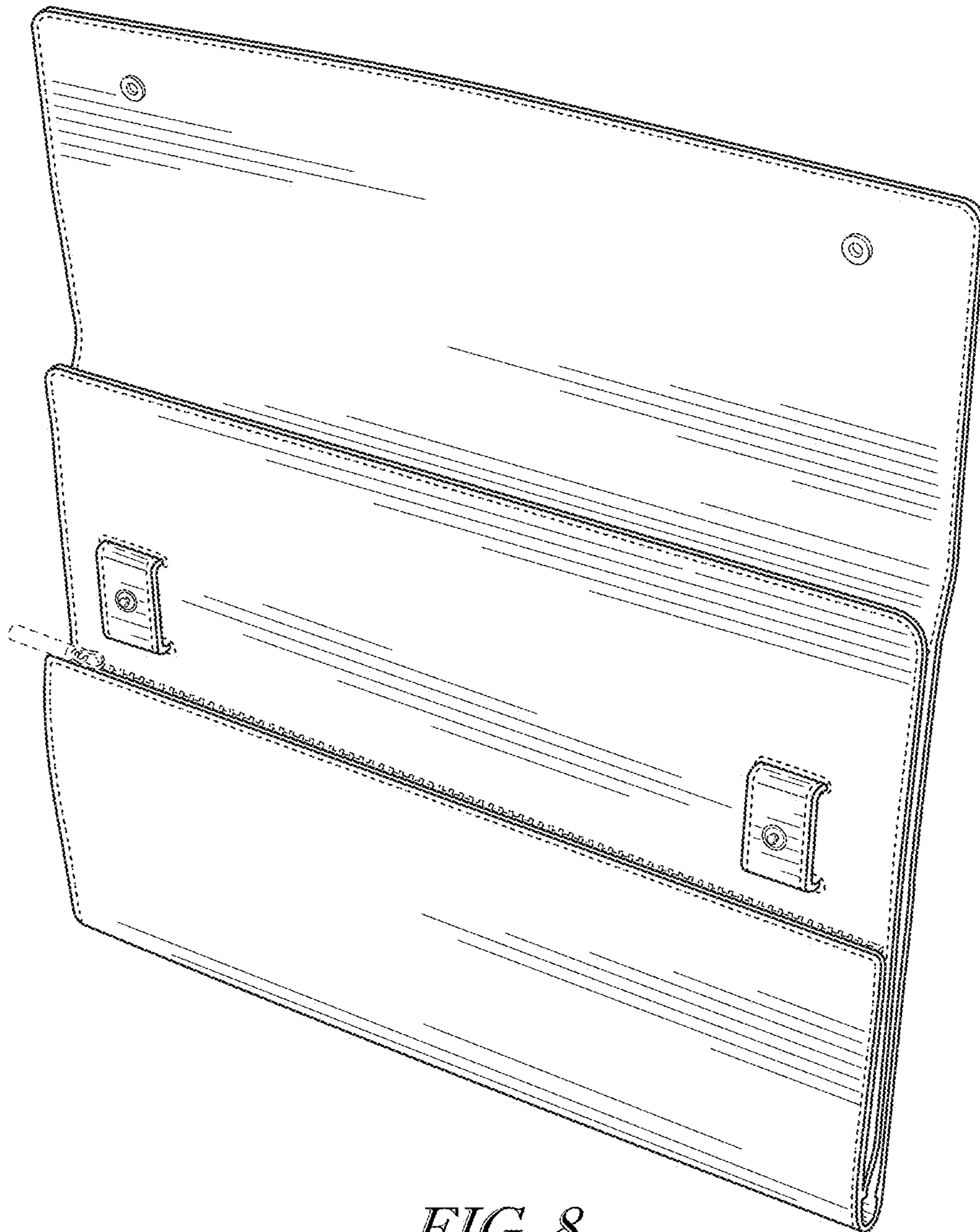

FIG. 8

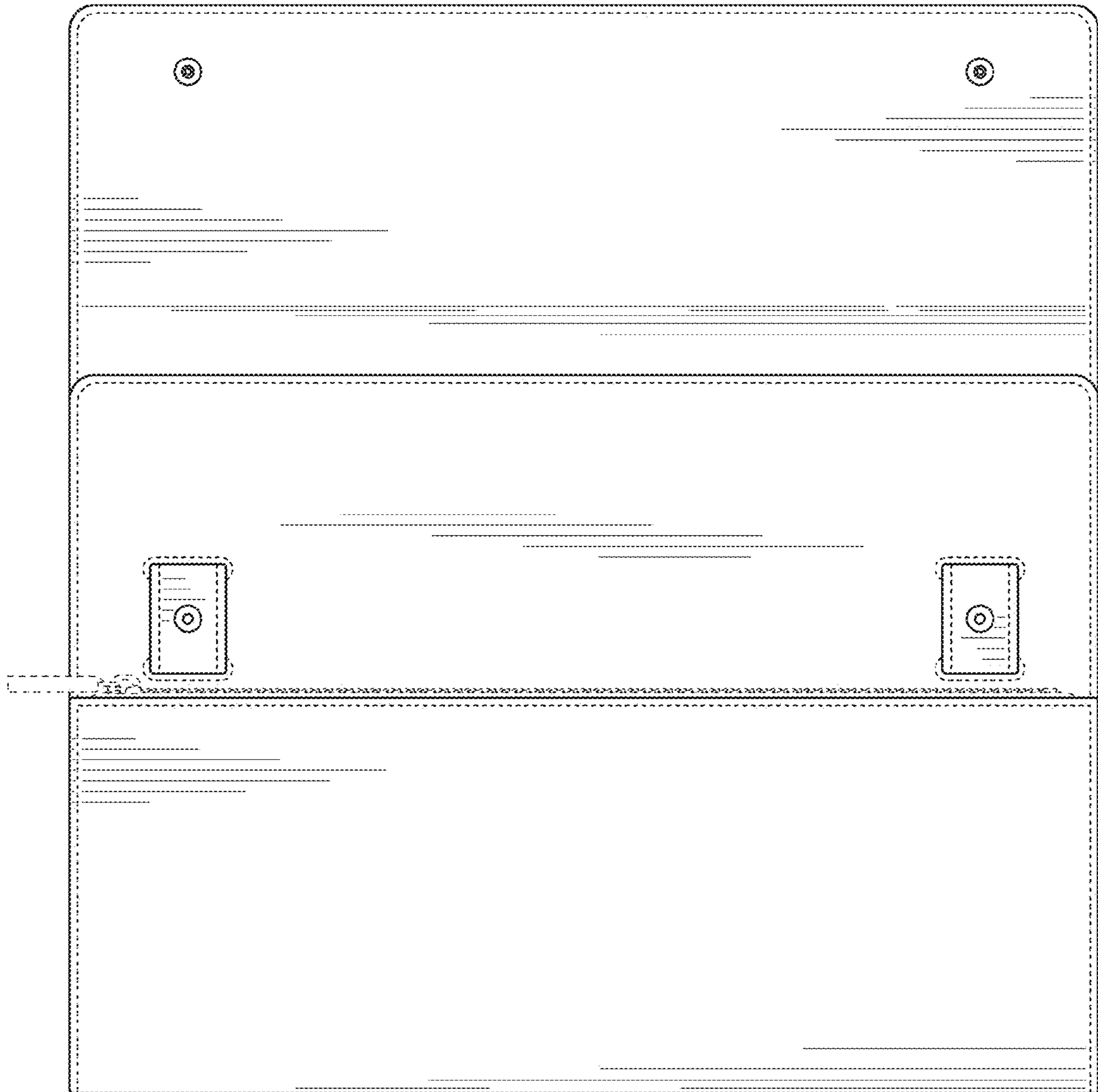

FIG. 9

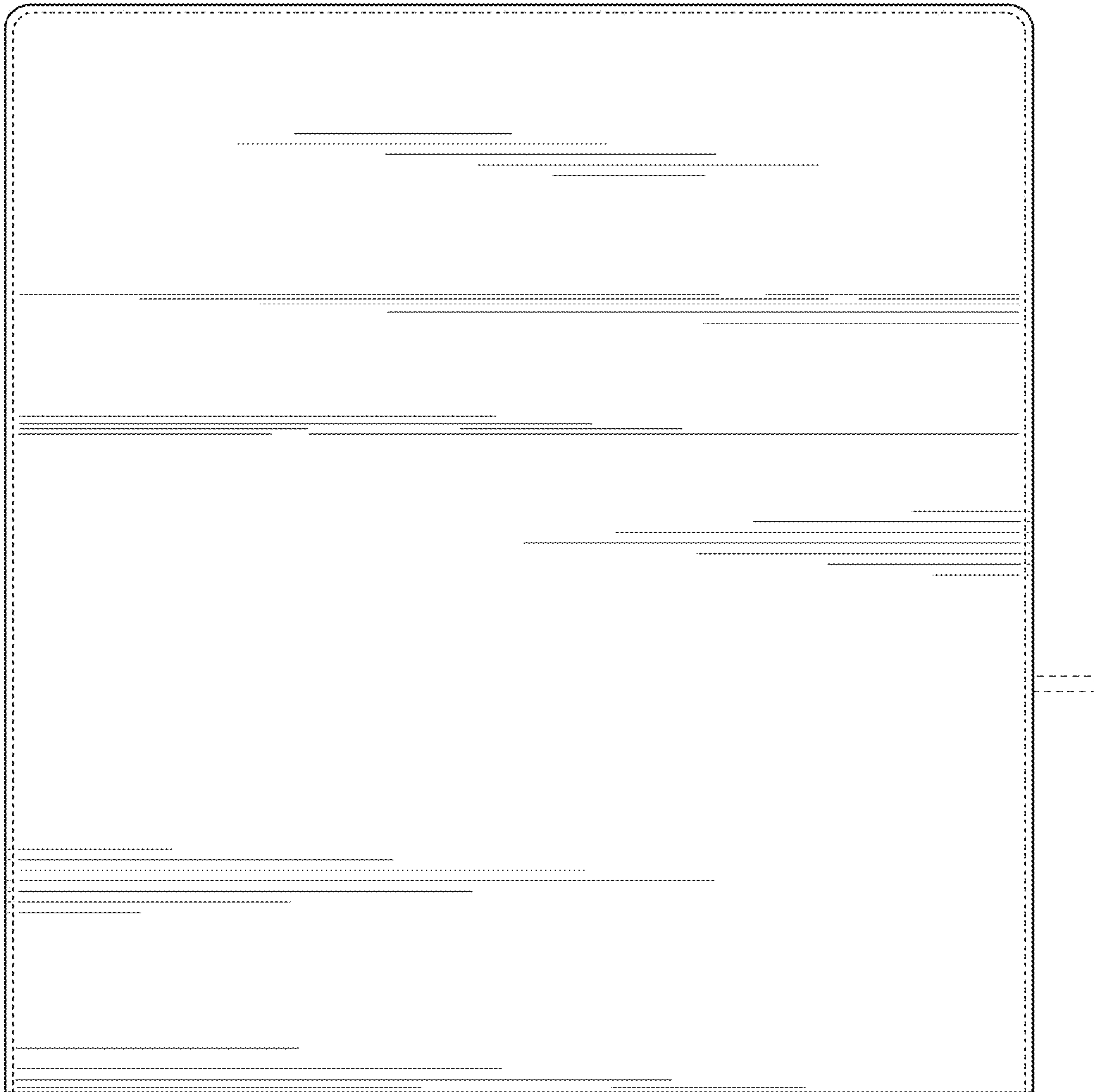

FIG. 10

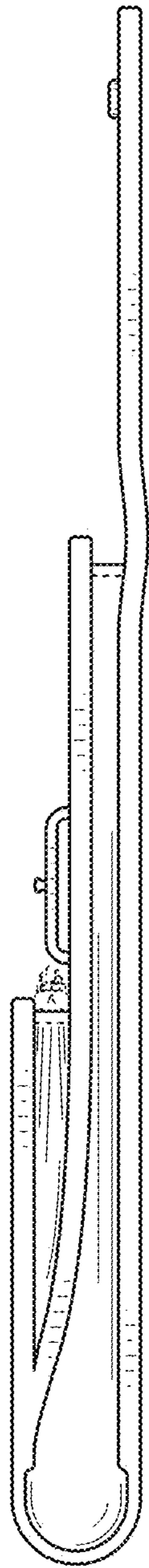

FIG. 11

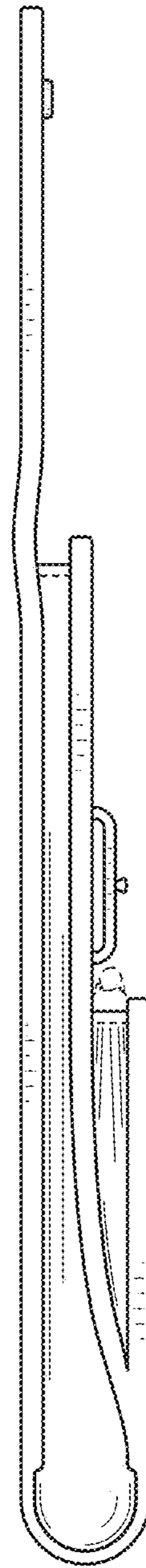

FIG. 12

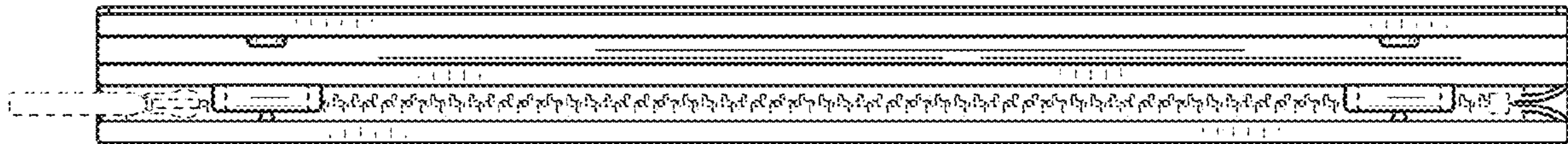

FIG. 13

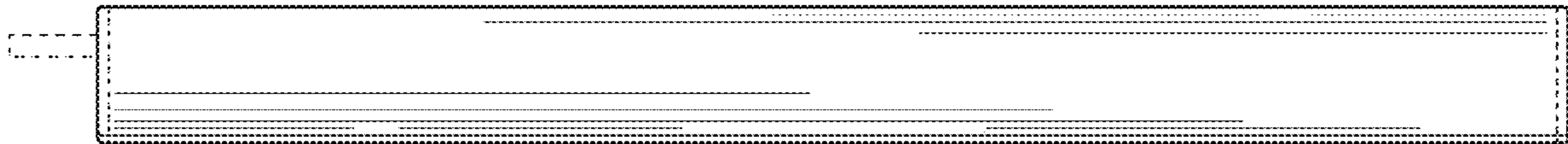

FIG. 14