



US00D902502S

(12) **United States Design Patent** (10) **Patent No.:** **US D902,502 S**
Favia (45) **Date of Patent:** **** Nov. 17, 2020**

(54) **GROOMING HAIR ACCUMULATOR FOR ANIMAL**

(71) Applicant: **Spectrum Brands, Inc.**, Middleton, WI (US)

(72) Inventor: **Adam Favia**, Reedsburg, WI (US)

(73) Assignee: **Spectrum Brands, Inc.**, Middleton, WI (US)

(**) Term: **15 Years**

(21) Appl. No.: **29/641,266**

(22) Filed: **Mar. 20, 2018**

(51) **LOC (12) Cl.** **30-99**

(52) **U.S. Cl.**
USPC **D30/158; D4/136**

(58) **Field of Classification Search**
USPC D30/158, 159; D4/116-123, 127-129, D4/130-138, 199; D32/40, 52
See application file for complete search history.

(56) **References Cited**

U.S. PATENT DOCUMENTS

D285,130 S *	8/1986	Wilkeson	D30/158
6,367,422 B1	4/2002	Wilhelmi		
D577,204 S *	9/2008	Libman	D4/129
D580,657 S *	11/2008	Libman	D4/129
D586,561 S *	2/2009	Libman	D4/129
D591,513 S *	5/2009	McNeil	D4/129
D632,087 S *	2/2011	Wang	D30/158
D743,703 S *	11/2015	Harrington	D4/138
D759,384 S *	6/2016	Libman	D4/138
D847,515 S *	5/2019	Renner	D4/129
D853,128 S *	7/2019	Tschopp	D4/129
D857,399 S *	8/2019	Renner	D4/129
2014/0158151 A1	6/2014	Sebagereka et al.		

OTHER PUBLICATIONS

“Furminator Pet Hair Remover Accumulator Head” available Sep. 3, 2017, [online], [site visited Apr. 15, 2020]. Retrieved from Internet, URL: <https://www.amazon.com/Furminator-Remover-Accumulator-FURflex-Remove/dp/B071JTKXQZ> (Year: 2017).*

* cited by examiner

Primary Examiner — Michael C Stout

Assistant Examiner — Katrina N Gonzalez

(74) *Attorney, Agent, or Firm* — Merchant & Gould P.C.

(57) **CLAIM**

The ornamental design for a grooming hair accumulator for animal, as shown and described.

DESCRIPTION

FIG. 1 is a top perspective view of a grooming hair accumulator for animal, showing our new design. FIG. 2 is a bottom perspective view thereof; FIG. 3 is a top plan view thereof; FIG. 4 is a bottom plan view thereof; FIG. 5 is a right side view, the left side view being a mirror image thereof; FIG. 6 is another perspective view, but shown with the handle and head separated for completeness of illustration. FIG. 7 is another perspective view, but shown with the handle removed for completeness of illustration. FIG. 8 is another perspective view thereof; and, FIG. 9 is another perspective view thereof. The broken lines illustrate portions of the grooming hair accumulator for animal that forms no part of the claimed design.

1 Claim, 9 Drawing Sheets

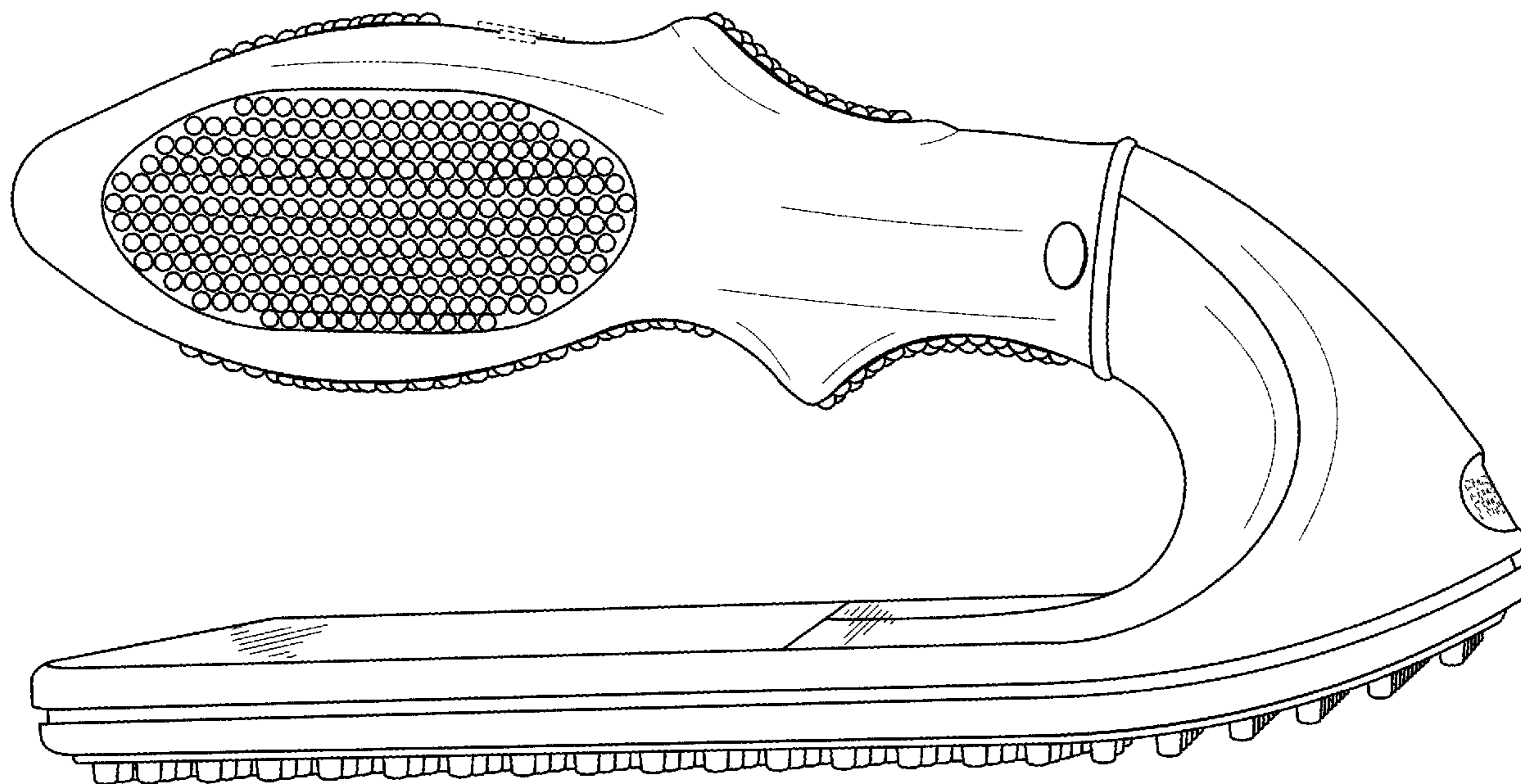

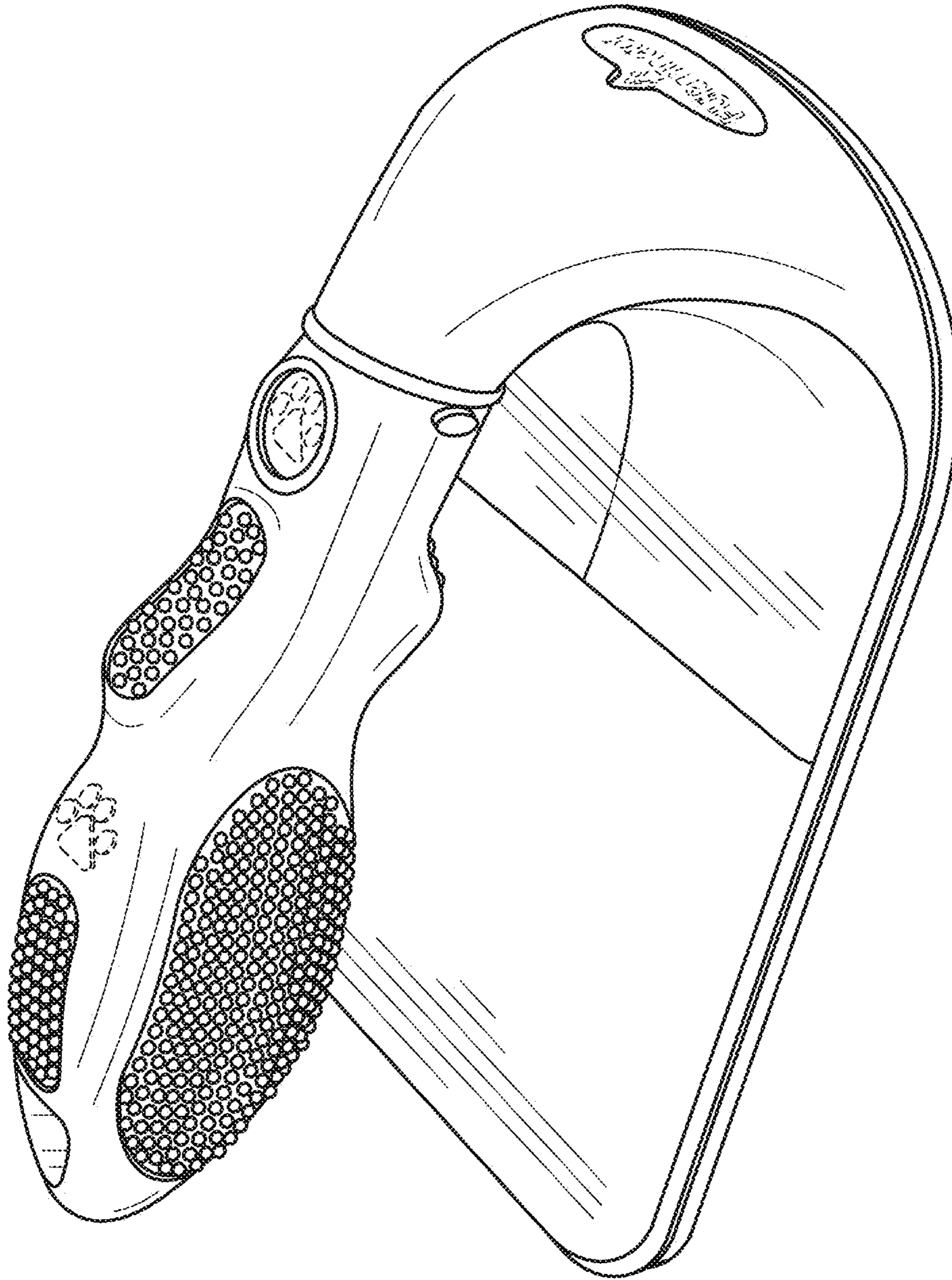

FIG. 1

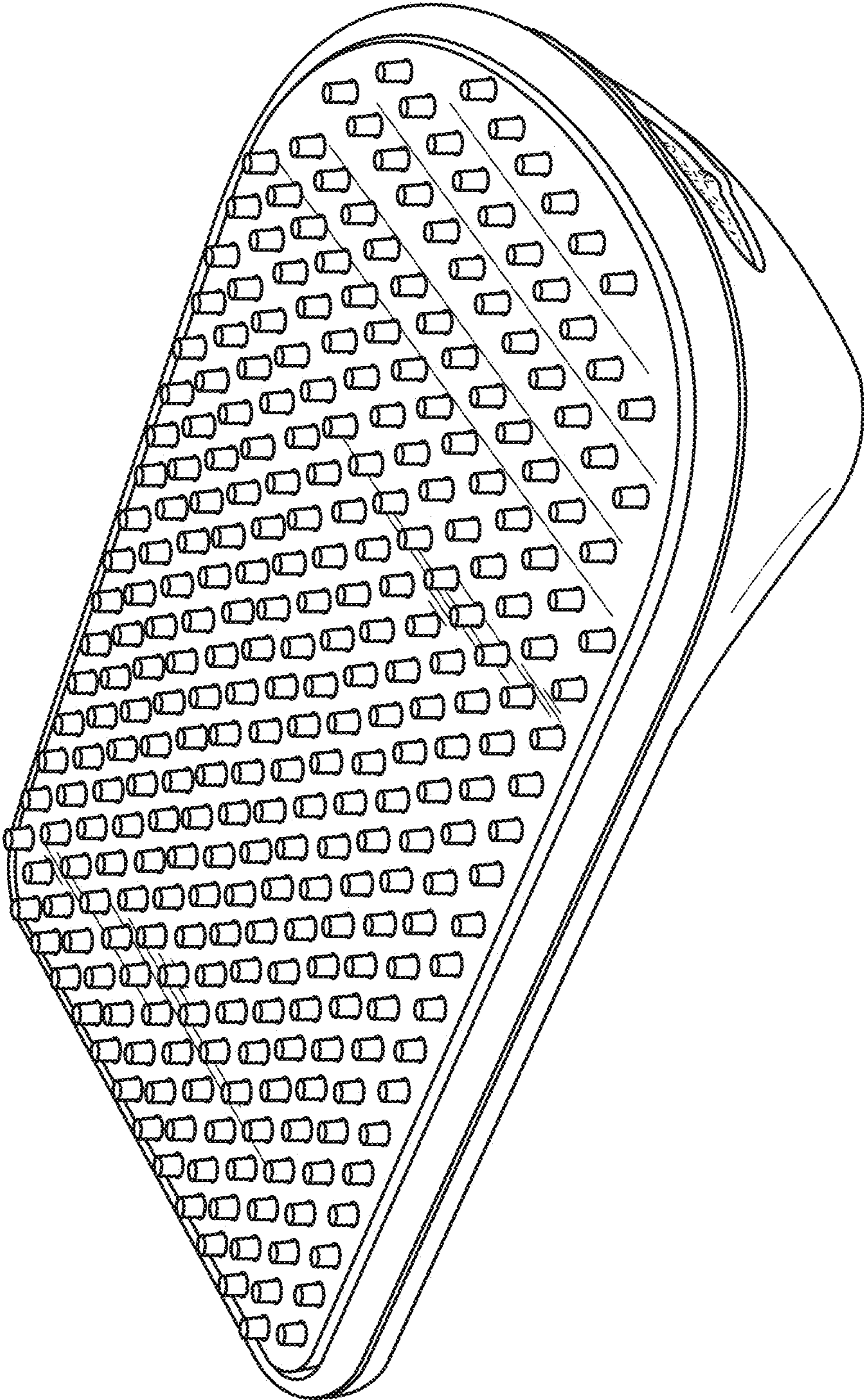

FIG. 2

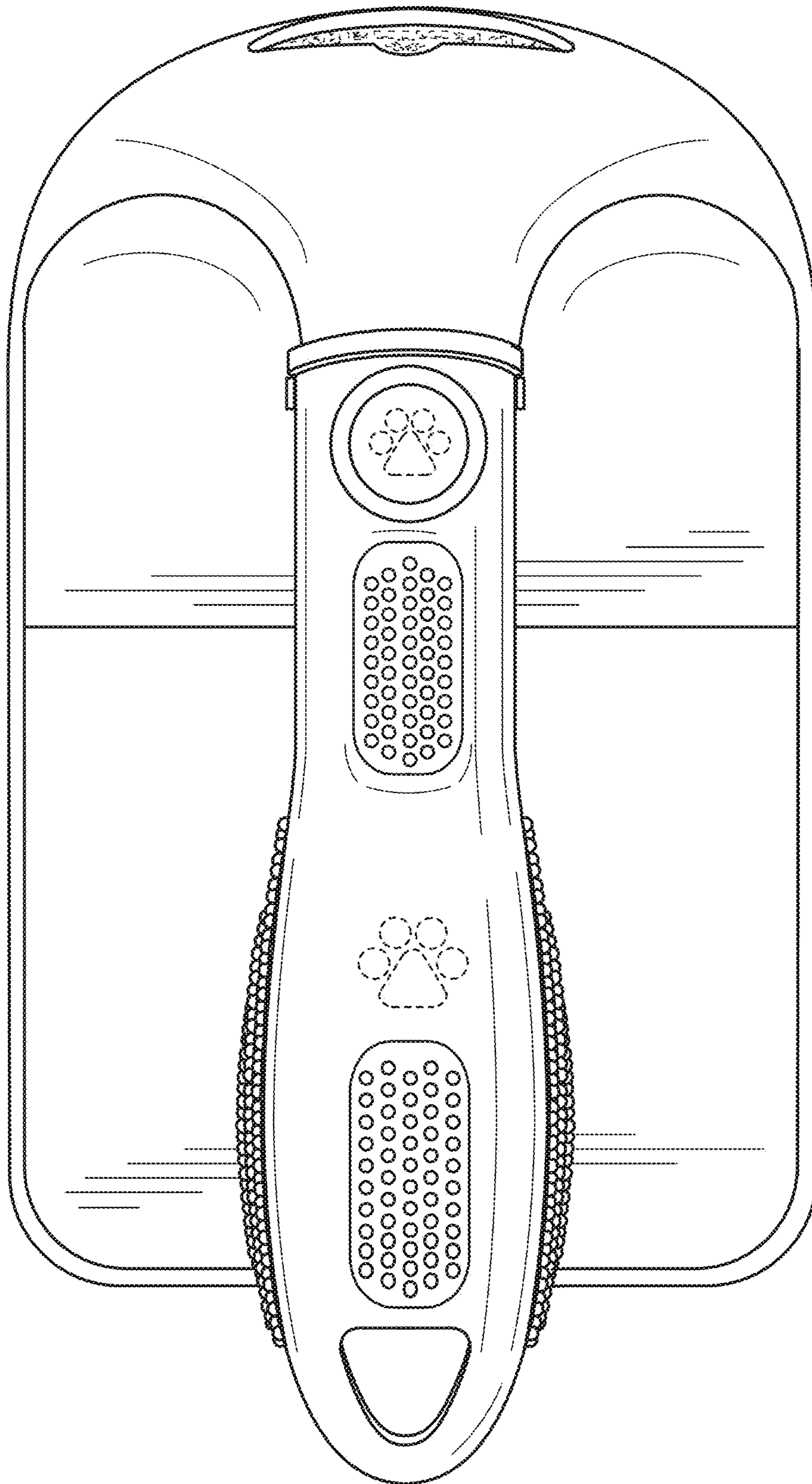

FIG. 3

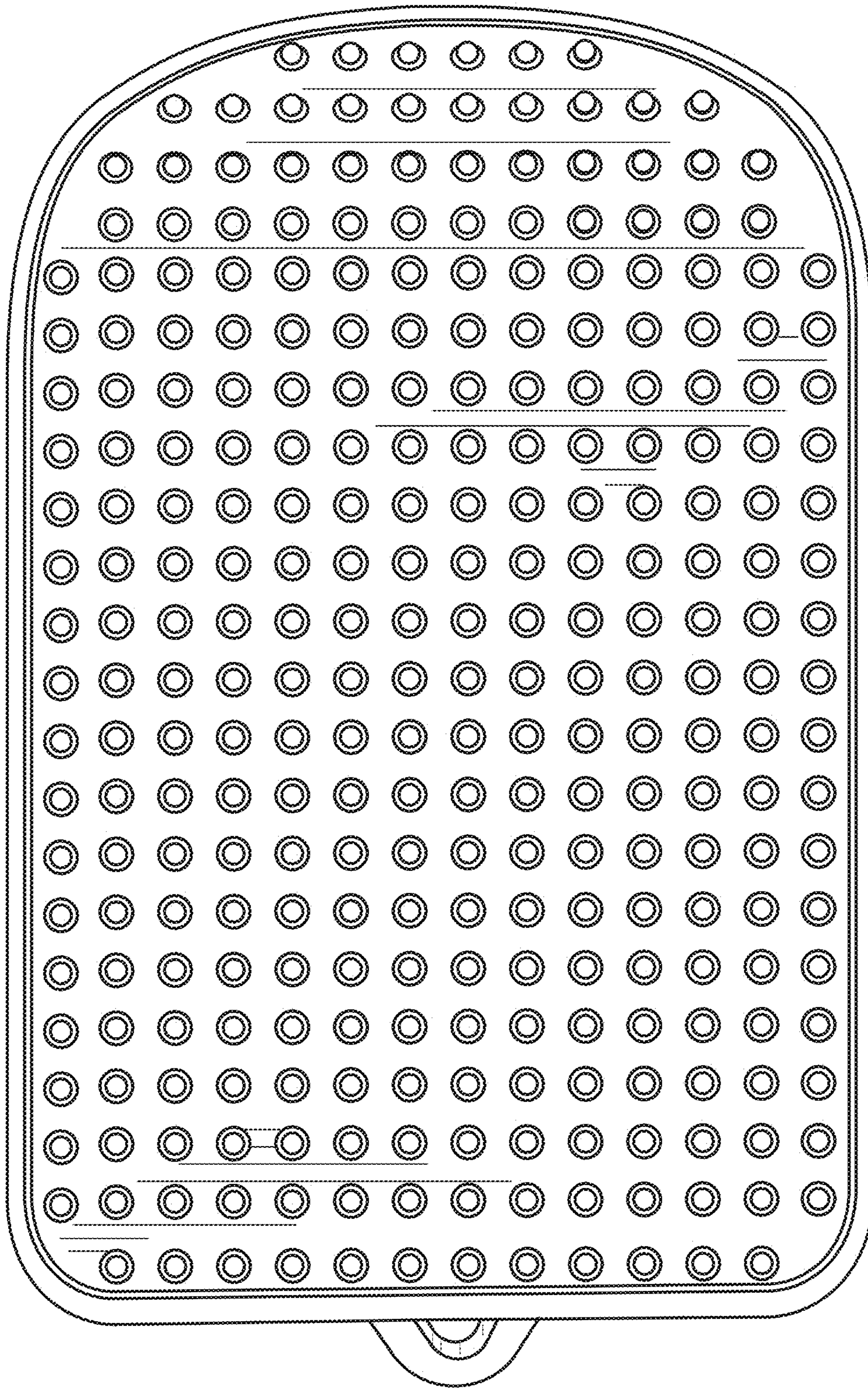

FIG. 4

FIG. 5

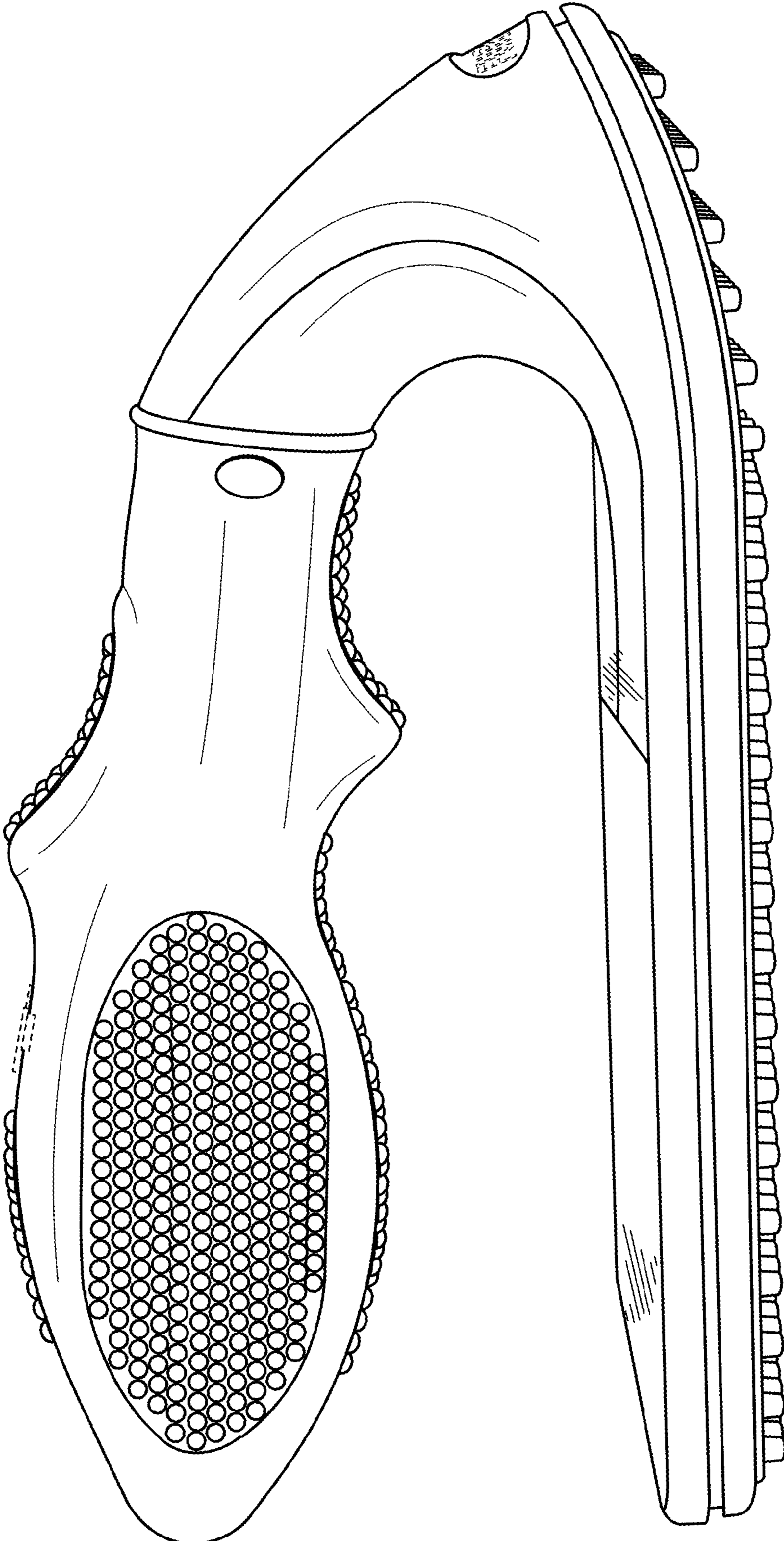
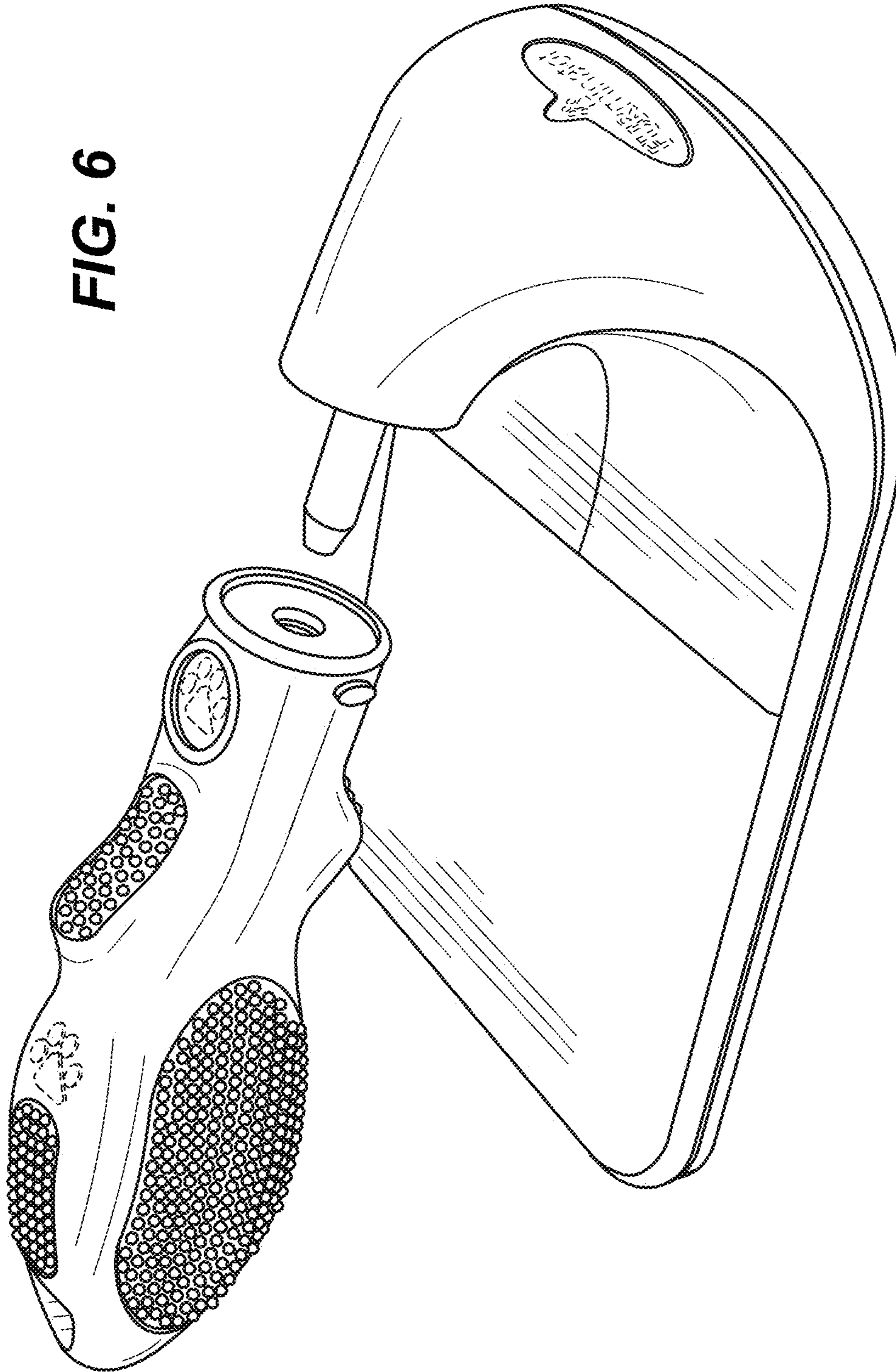

FIG. 6



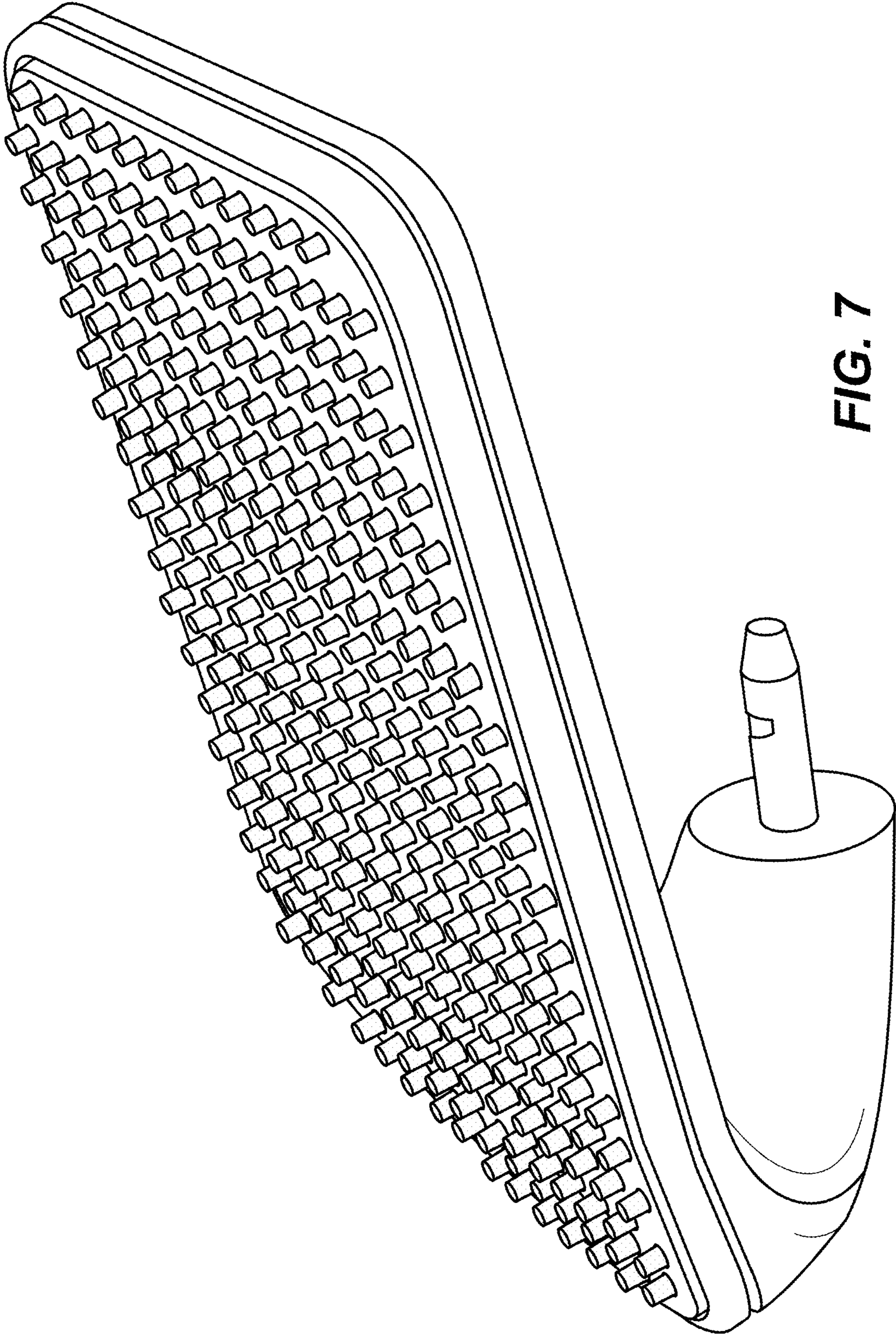

FIG. 7

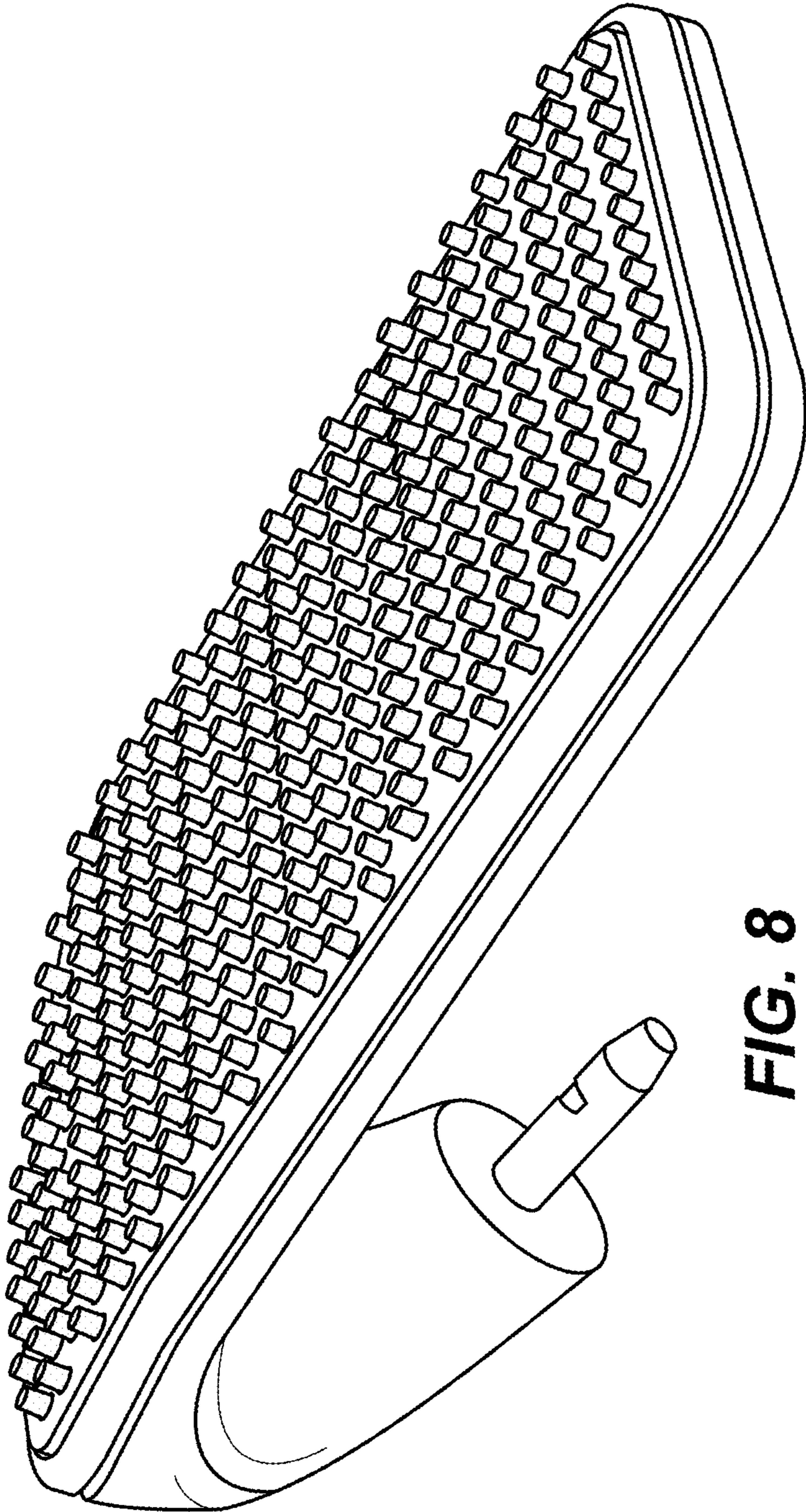

FIG. 8

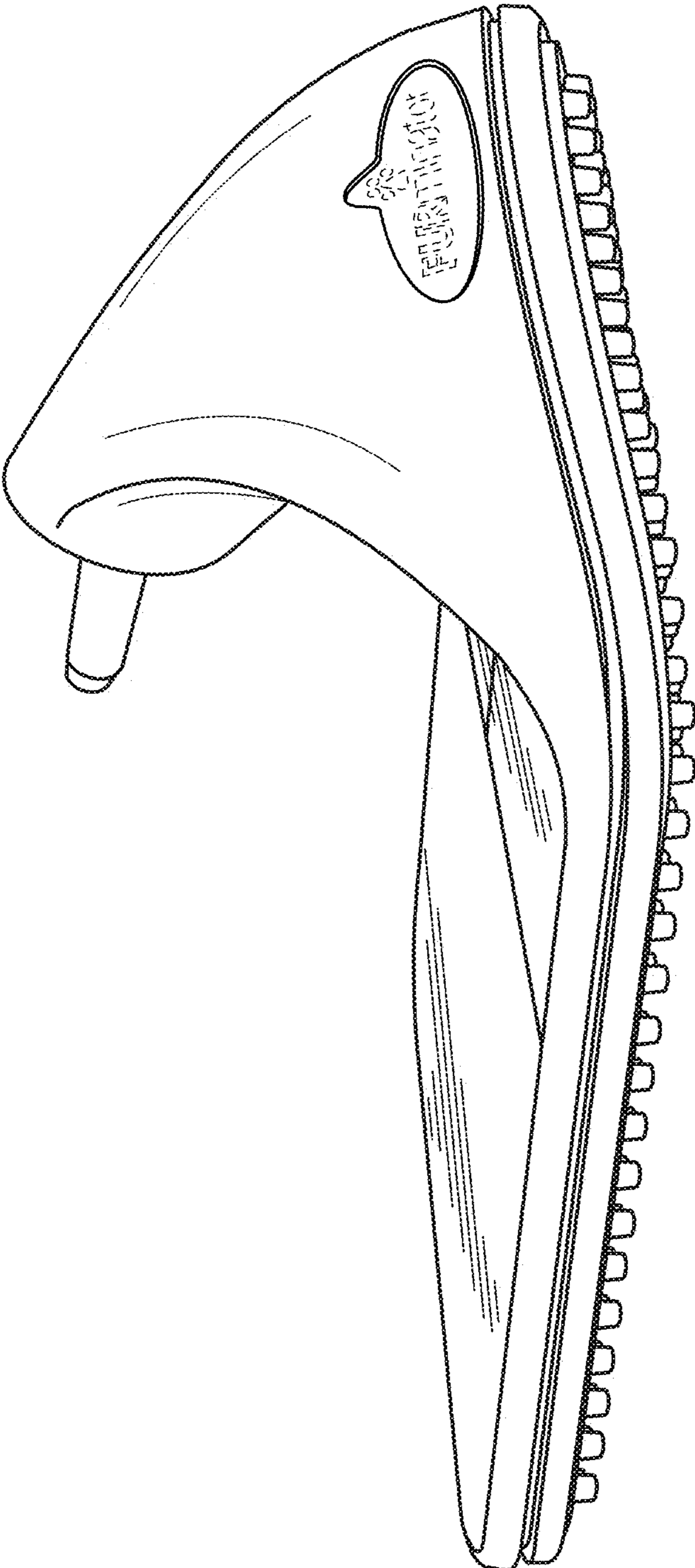

FIG. 9