



US00D902475S

(12) **United States Design Patent** (10) **Patent No.:** **US D902,475 S**  
**Liu** (45) **Date of Patent:** **\*\* Nov. 17, 2020**

(54) **ELECTRONIC CIGARETTE**  
(71) Applicant: **FIFTY HUNDRED THOUSAND LIMITED**, Hongkong (CN)  
(72) Inventor: **Huailong Liu**, Jieshou (CN)  
(\*\*) Term: **15 Years**  
(21) Appl. No.: **29/689,415**

D860,517 S \* 9/2019 Qiu ..... D27/101  
D863,673 S \* 10/2019 Lai ..... D27/162  
D873,215 S \* 1/2020 Wu ..... D13/108  
D882,065 S \* 4/2020 Wang ..... D24/110  
D892,124 S \* 8/2020 Shim ..... D14/435  
2018/0213847 A1 \* 8/2018 Reevell ..... A24F 47/008  
2019/0008208 A1 \* 1/2019 Cirillo ..... A24F 7/04  
2019/0173508 A1 \* 6/2019 Martin ..... A24F 40/50  
2019/0297946 A1 \* 10/2019 Fu ..... H05B 3/44  
2019/0313694 A1 \* 10/2019 Wei ..... A24F 47/008  
2020/0107583 A1 \* 4/2020 Wu ..... F16B 1/00

(22) Filed: **Apr. 30, 2019**  
(51) **LOC (12) Cl.** ..... **27-02**  
(52) **U.S. Cl.**  
USPC ..... **D27/162; D27/101**  
(58) **Field of Classification Search**  
USPC ..... D27/162, 100, 101, 139, 141, 148,  
D27/161-171, 183, 185-193, 194;  
D24/110, 110.5, 129, 113, 112; D13/108,  
D13/144, 103, 119, 146, 168; D23/360,  
D23/364-366; D19/163, 161; D14/434,  
D14/480.5, 480.1, 480.3, 483, 484.1;  
D4/121  
CPC ..... A24F 40/00; A24F 40/40; A24F 40/42;  
A24F 40/05; A24F 40/46; A24F 47/002;  
A24F 47/008; A24D 1/14; A24D 1/042;  
A24D 1/02; G06F 3/03545  
See application file for complete search history.

**FOREIGN PATENT DOCUMENTS**

EM 006380184-0001 \* 4/2019  
EM 006407235-0001 \* 5/2019

\* cited by examiner

*Primary Examiner* — Dana K Weiland  
*Assistant Examiner* — Mary Claire Ramirez

(57) **CLAIM**

The ornamental design for an electronic cigarette, as shown and described.

**DESCRIPTION**

FIG. 1 is a first perspective view of an electronic cigarette showing my design;  
FIG. 2 is a second perspective view thereof;  
FIG. 3 is a front view thereof;  
FIG. 4 is a back view thereof;  
FIG. 5 is a left side view thereof;  
FIG. 6 is a right side view thereof;  
FIG. 7 is a top view thereof; and,  
FIG. 8 is a bottom view thereof.  
The broken lines shown in the drawings depict portions of the electronic cigarette in which the design is embodied that form no part of the claimed design.

(56) **References Cited**  
**U.S. PATENT DOCUMENTS**

D494,313 S \* 8/2004 Wong ..... D27/141  
D818,434 S \* 5/2018 Doiron ..... D13/108  
D819,023 S \* 5/2018 Shim ..... D14/363  
D829,980 S \* 10/2018 Qiu ..... D27/162  
D833,063 S \* 11/2018 Qiu ..... D27/101  
D846,796 S \* 4/2019 Pan ..... D27/101  
D847,812 S \* 5/2019 Shim ..... D14/356  
D853,632 S \* 7/2019 Qiu ..... D27/101

**1 Claim, 8 Drawing Sheets**

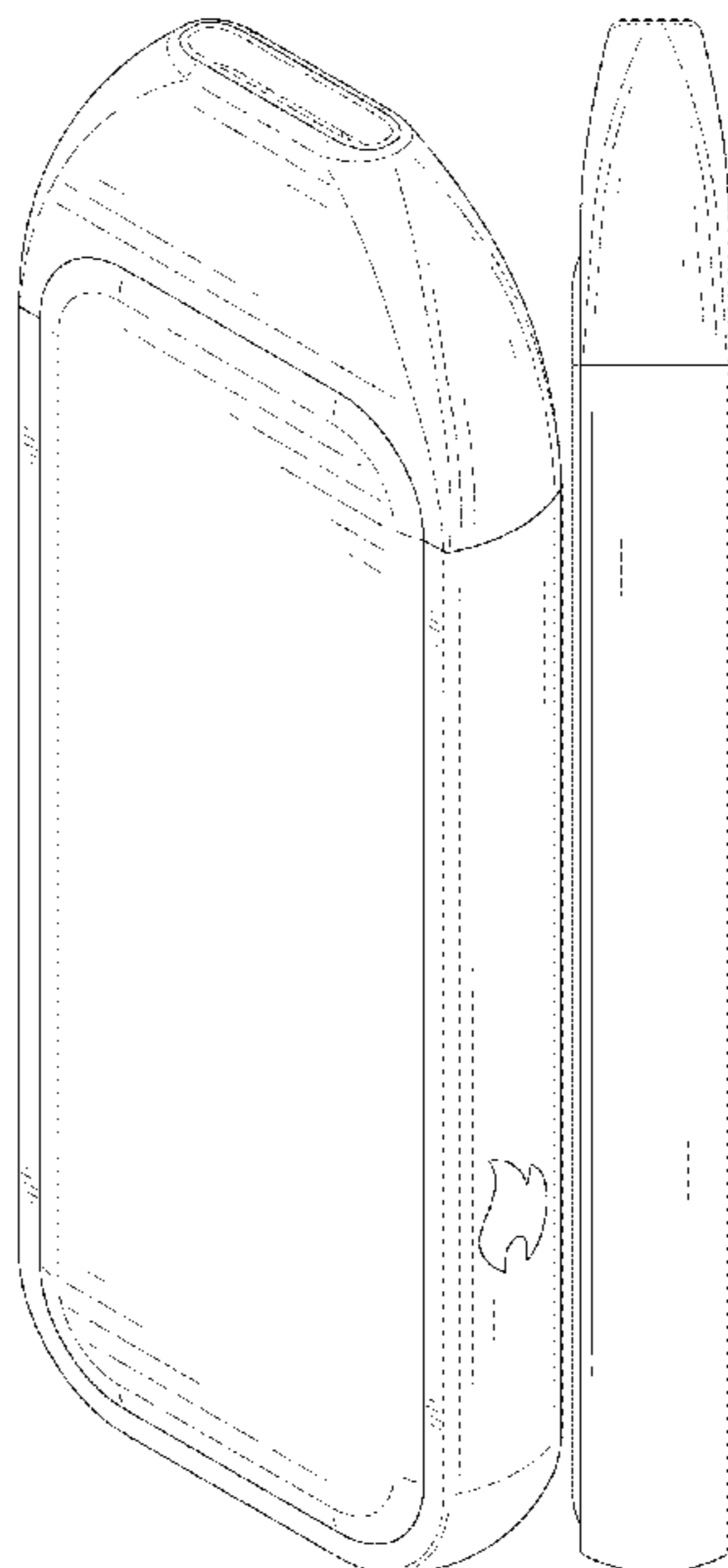

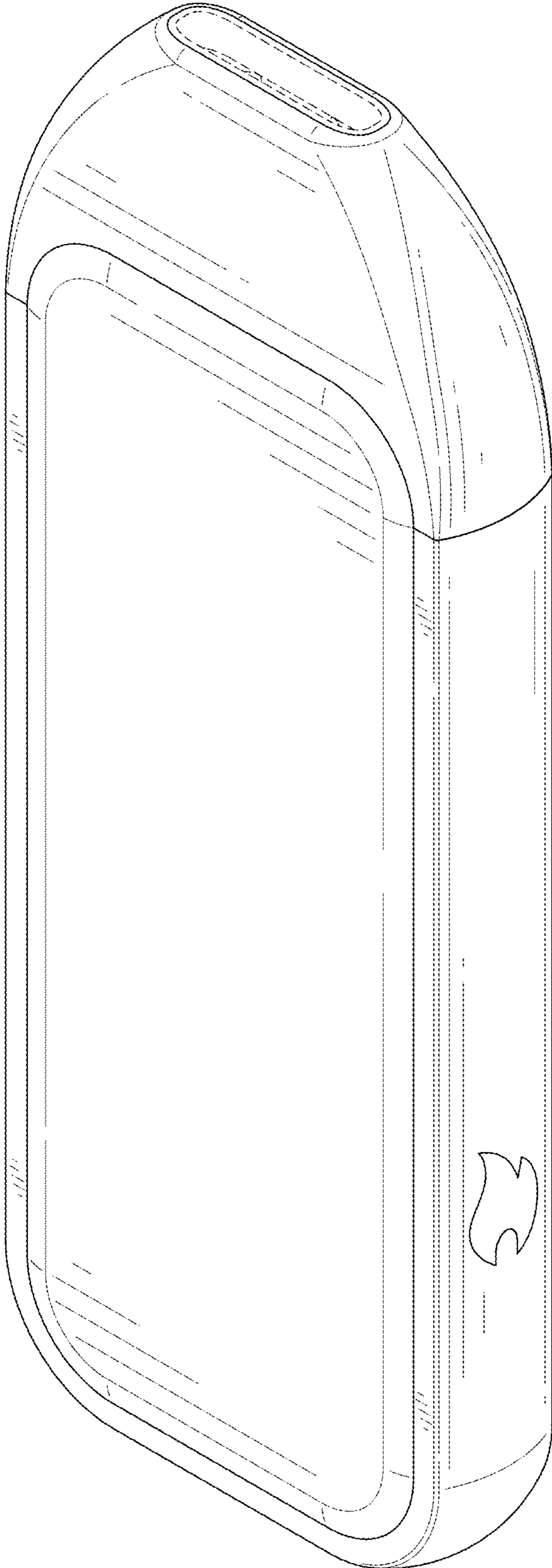

FIG. 1

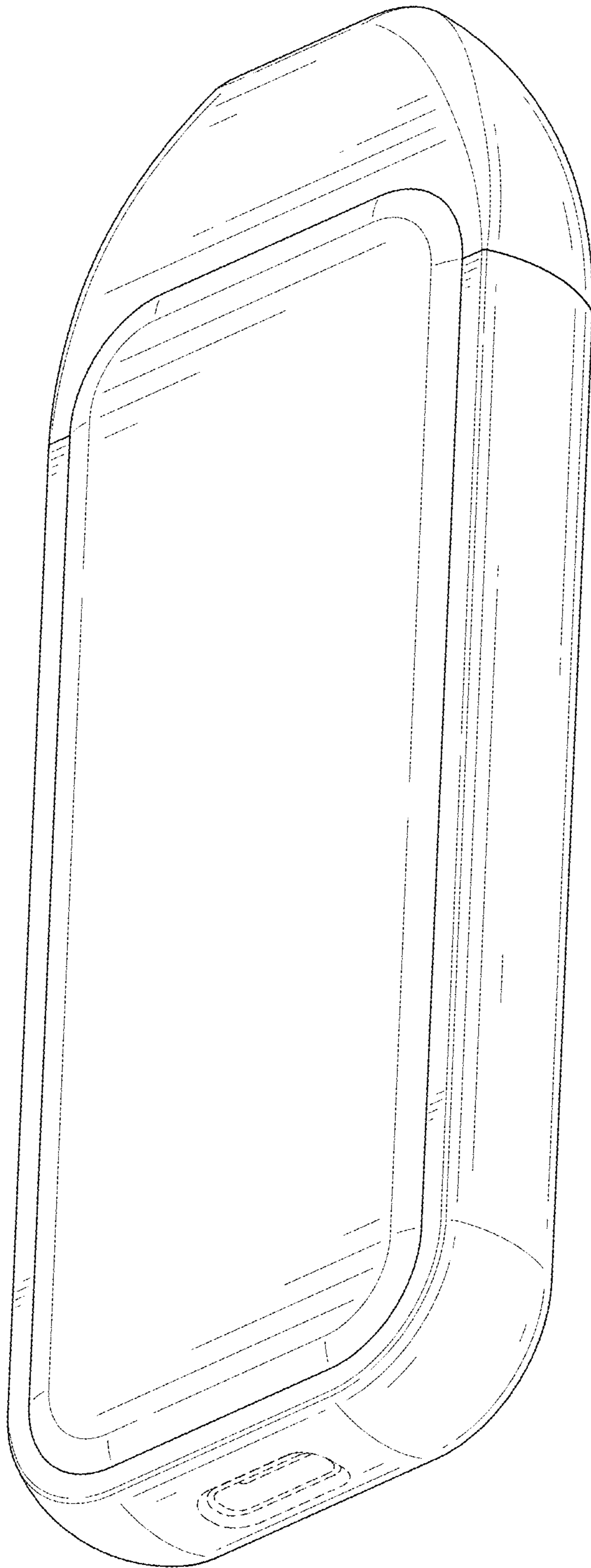

FIG. 2

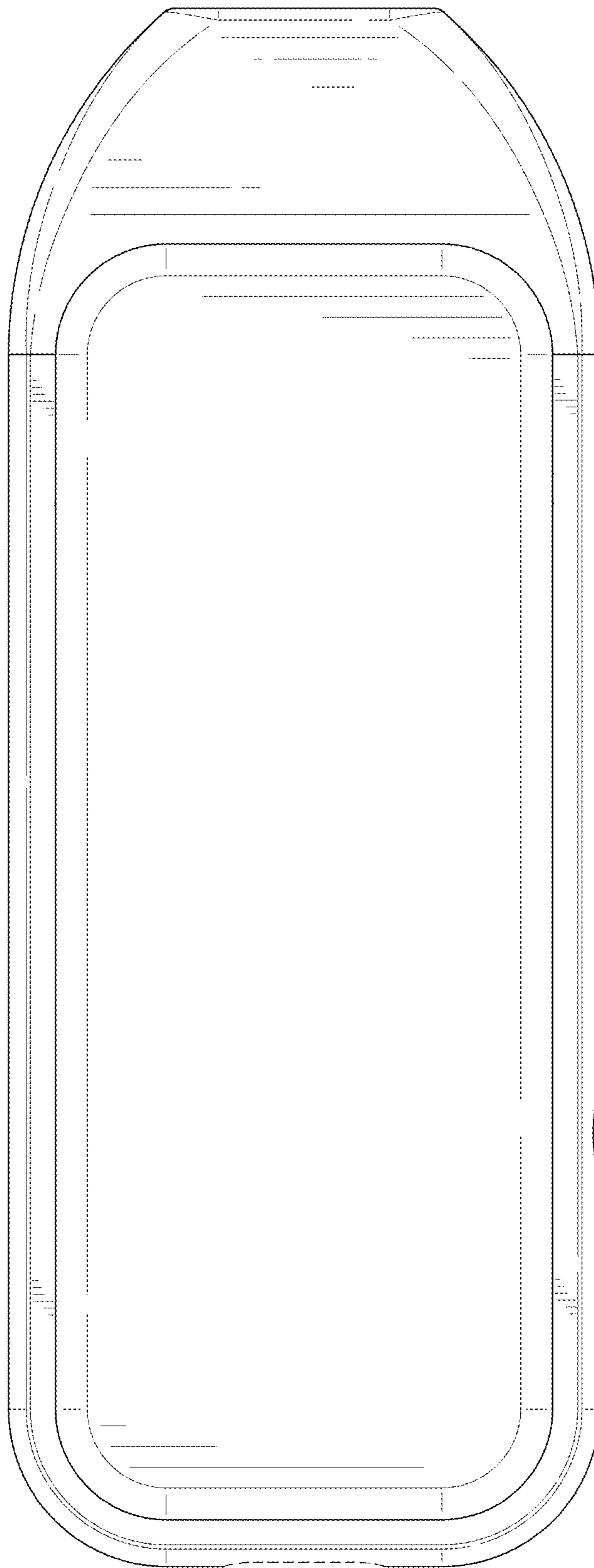

FIG. 3

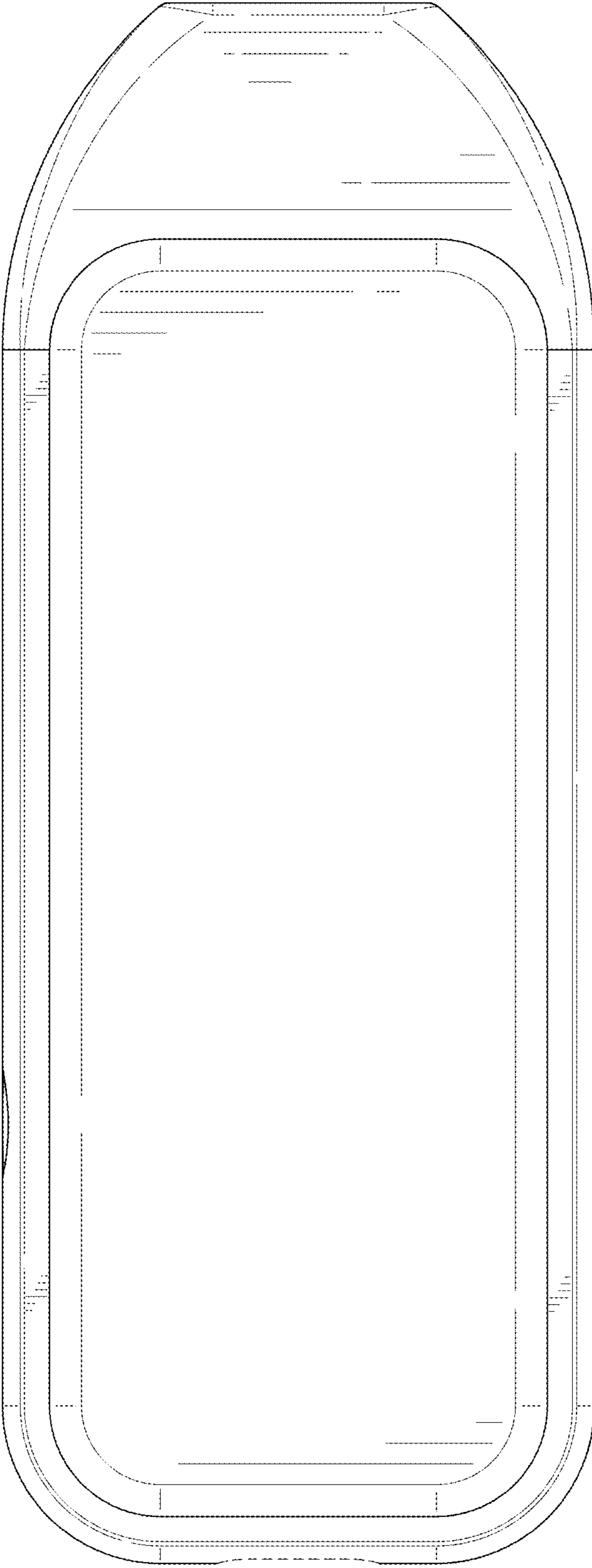

FIG. 4

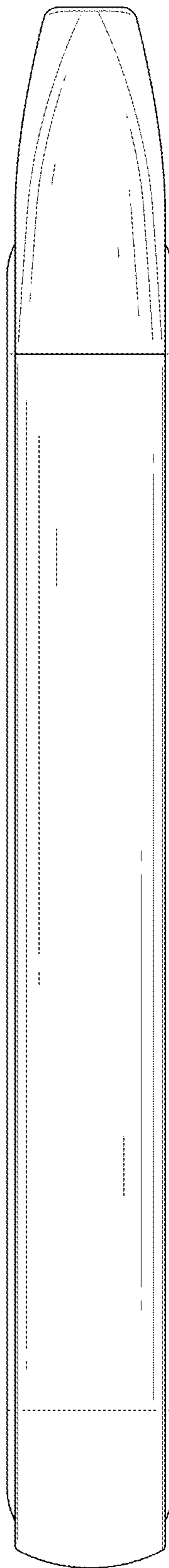

FIG. 5

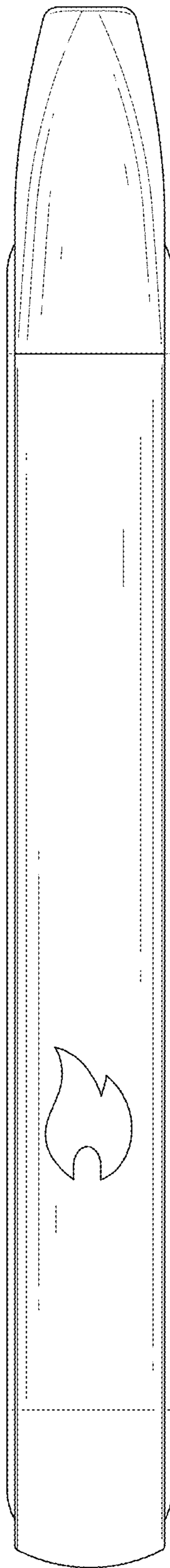

FIG. 6

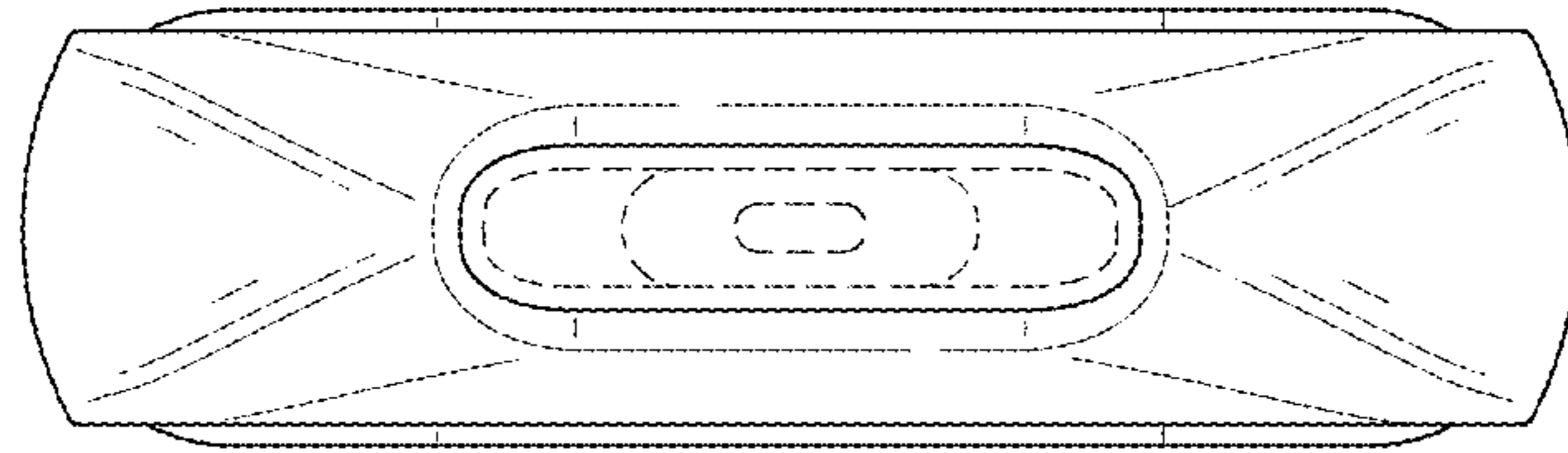

FIG. 7



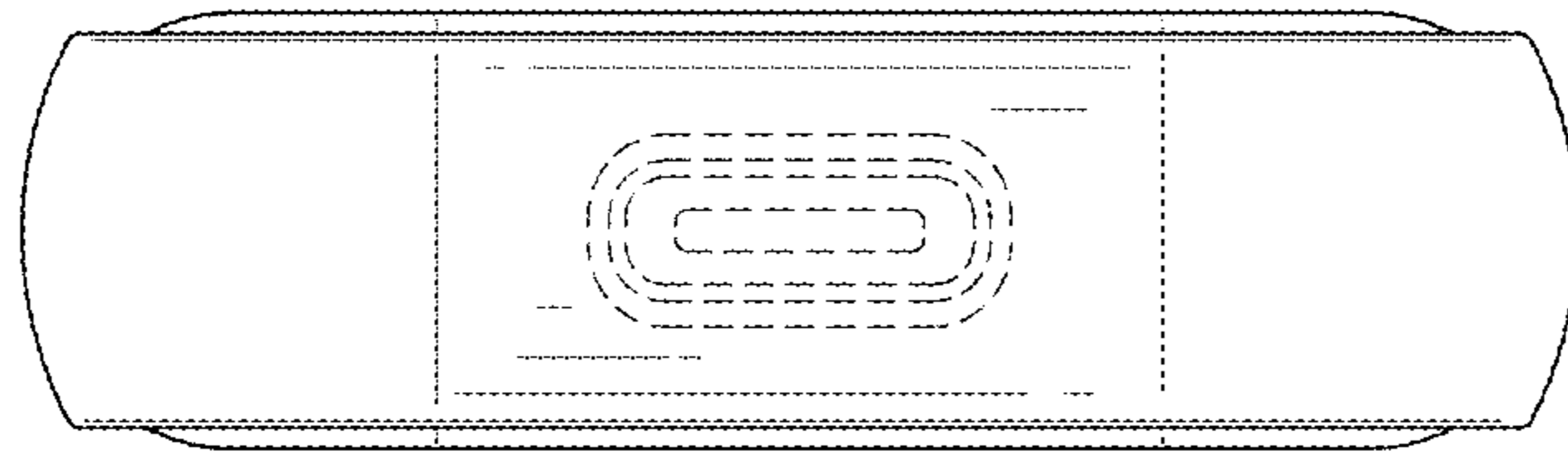

FIG. 8