



US00D902378S

(12) **United States Design Patent** (10) **Patent No.:** **US D902,378 S**
McRoberts (45) **Date of Patent:** **** Nov. 17, 2020**

(54) **CEILING FAN BLADE**
(71) Applicant: **HUNTER FAN COMPANY**,
Memphis, TN (US)
(72) Inventor: **Claire Bernice McRoberts**, La Jolla,
CA (US)
(73) Assignee: **Hunter Fan Company**, Memphis, TN
(US)

D505,724 S 5/2005 Tai
D507,644 S 7/2005 Tai
D516,207 S 2/2006 Tai
D516,208 S 2/2006 Tai
D516,711 S 3/2006 Tai
D517,202 S 3/2006 Tai
D517,689 S 3/2006 Tai
D524,439 S 7/2006 Tai

(Continued)

(**) Term: **15 Years**
(21) Appl. No.: **29/716,691**
(22) Filed: **Dec. 11, 2019**

Related U.S. Application Data

(62) Division of application No. 29/650,183, filed on Jun.
5, 2018, now Pat. No. Des. 873,405.
(51) **LOC (12) Cl.** **23-03**
(52) **U.S. Cl.**
USPC **D23/413**
(58) **Field of Classification Search**
USPC D23/370-385, 411-414; D12/214
CPC F04D 25/088; F04D 29/38; F04D 29/384;
F04D 29/386; F21V 33/0096
See application file for complete search history.

(56) **References Cited**

U.S. PATENT DOCUMENTS

5,151,011 A 9/1992 Rezek
D345,790 S 4/1994 Caldwell
D477,072 S * 7/2003 Johnson D23/413
D490,510 S * 5/2004 Cohen D23/379
D503,472 S 3/2005 Tai
D503,473 S 3/2005 Tai
D503,474 S 3/2005 Tai
D503,475 S 3/2005 Tai
D503,476 S 3/2005 Tai
D503,795 S 4/2005 Tai

OTHER PUBLICATIONS

<http://www.fanimation.com/products/index.php/fans/berlin.html>,
Fanimation Berlin, Model No. LP8064, accessed Jan. 4, 2018.

(Continued)

Primary Examiner — Cathron C Brooks
Assistant Examiner — Sharon S Oum
(74) *Attorney, Agent, or Firm* — McGarry Bair PC

(57) **CLAIM**

The ornamental design for a ceiling fan blade, as shown and
described.

DESCRIPTION

FIG. 1 is a top perspective view of a ceiling fan blade,
showing my new design;
FIG. 2 is a bottom perspective view thereof;
FIG. 3 is a right side view thereof;
FIG. 4 is a left side view thereof;
FIG. 5 is a front view thereof;
FIG. 6 is a rear view thereof;
FIG. 7 is a top view thereof; and,
FIG. 8 is a bottom view thereof.
Portions of the ceiling fan blade shown in broken lines form
no part of the claimed design. The ceiling fan blade is shown
with a symbolic break in its length. The appearance of any
portion of the ceiling fan blade between the break lines
forms no part of the claimed design.

1 Claim, 6 Drawing Sheets

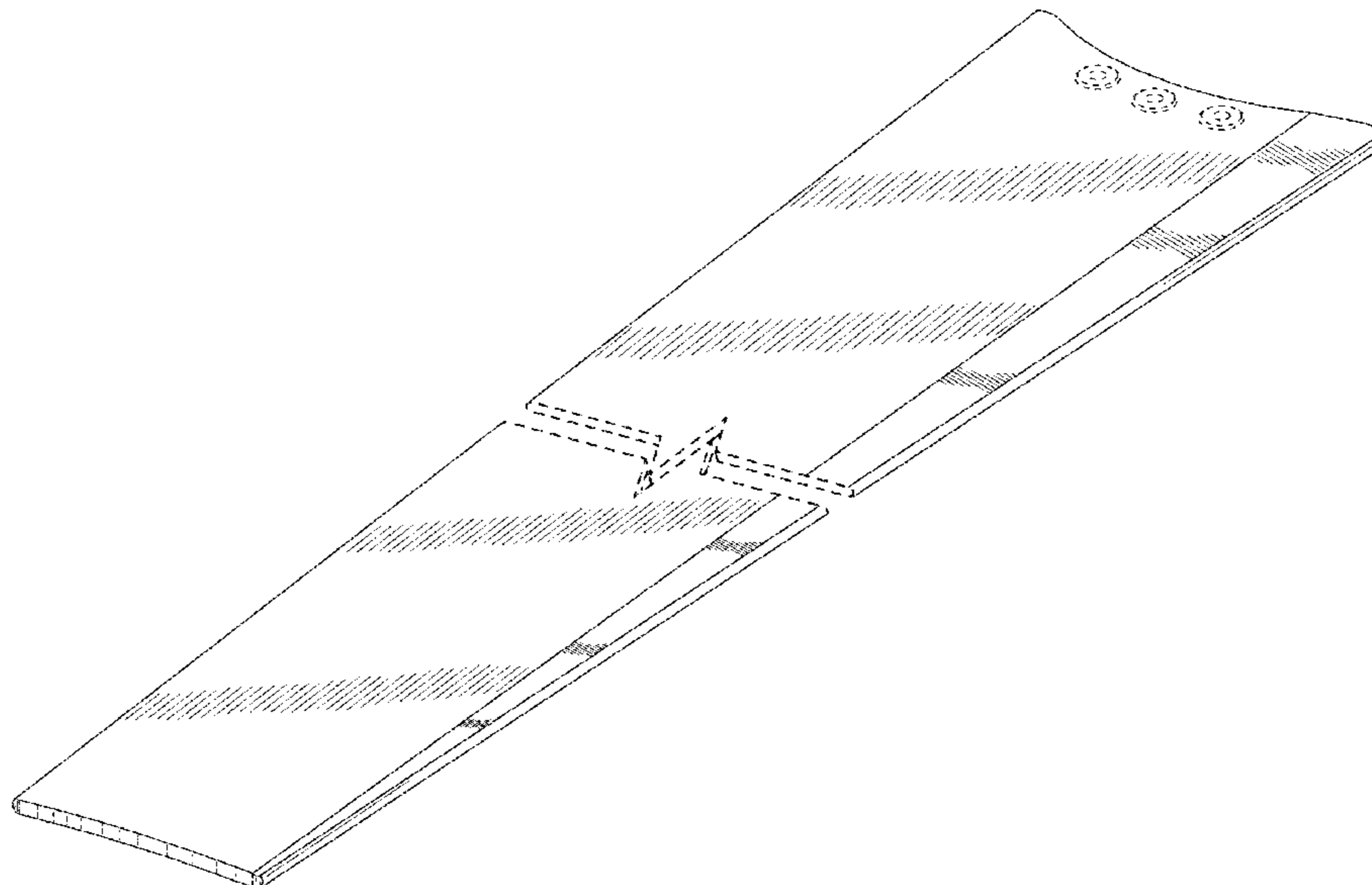

(56)

References Cited

OTHER PUBLICATIONS

U.S. PATENT DOCUMENTS

D527,097 S 8/2006 Ertze
 D628,687 S 12/2010 Yao
 D628,688 S * 12/2010 Pan D23/377
 D679,795 S 4/2013 Allen et al.
 D706,406 S 6/2014 Wang
 D707,336 S 6/2014 Pan
 D715,418 S 10/2014 Schulzman
 D726,299 S * 4/2015 Schulzman D23/413
 D744,081 S 11/2015 Wang
 D745,658 S * 12/2015 Wang D23/413
 D750,221 S 2/2016 Schulzman
 D759,799 S 6/2016 Wang
 D785,848 S 5/2017 Couture
 D794,768 S 8/2017 Wang
 D796,659 S 9/2017 Schulzman
 D797,980 S 9/2017 Maxik et al.
 D799,661 S 10/2017 Holmes
 D800,289 S 10/2017 Guthrie
 D800,370 S 10/2017 Sonneman
 D800,891 S 10/2017 McRoberts et al.
 D804,629 S 12/2017 McRoberts et al.
 D804,639 S 12/2017 Guthrie
 D805,175 S 12/2017 Haggar
 D819,799 S 6/2018 Wang
 D822,192 S 7/2018 Haggar
 D826,395 S 8/2018 McRoberts et al.
 D831,268 S 10/2018 Johnson
 D834,174 S * 11/2018 Fuselier D23/413
 D850,602 S 6/2019 Flores
 D850,603 S 6/2019 Wang
 D850,605 S 6/2019 Ertze
 D853,553 S * 7/2019 Niemiec D23/413
 D873,405 S * 1/2020 McRoberts D23/377
 D877,883 S * 3/2020 Schulzman D23/413
 D878,500 S * 3/2020 Jones D21/697
 2008/0069698 A1 * 3/2008 Laisathit F04D 29/34
 416/210 R
 2010/0129225 A1 * 5/2010 Itou F04D 29/023
 416/204 R

<https://www.hunterfan.com/ceiling-fans/aker-with-led-light-36-inch-fam812>, Hunter Aker with LED Light 36 Inch, Model No. 59303, accessed Jan. 4, 2018.
<http://kingoffans.com/photos/manuals/137.pdf>, King of Fans, Argenta, Model No. 52-AGT, Instruction Manual—Excel Lighting & Manufacturing Co, accessed Jan. 4, 2018.
<http://www.minkagroup.net/products/f524-orb>, Minka Roto 52" 3 Blade Ceiling Fan in Oil Rubbed Bronze Finish, Model No. F524-ORD, accessed Jan. 4, 2018.
<http://www.montecarlofans.com/50213/56-Avvo-Grey-3AVOR56GRYD.html>. Monte Carlo Avvo Collection, 56" Ceiling Fan, Product No. 3AVOR56GRYD, accessed Jan. 4, 2018.
<https://www.hunterfan.com/ceiling-fans/parmer-low-profile-with-light-46-inch-fam816>, Hunter Parmer Low Profile with Light 46 Inch, Model No. 59166, accessed Jan. 4, 2018.
<http://www.kichler.com/products/product/56-ellys-ceiling-fan-oz-300239oz.aspx>, Kichler Ellys 56 Ceiling Fan, Model No. 300239OZ, accessed Jan. 4, 2018.
<http://www.minkagroup.net/products/f787-orb>, Minka Simple, 52" 3 Blades Ceiling Fan in Oil Rubbed Bronze Finish, Model No. F787-ORB, accessed Jan. 4, 2018.
<http://www.crompton.co.in/riviera-style/>, Crompton Riviera Style, accessed Jan. 4, 2018.
<https://www.homedepot.com/p/GE-Savanna-52-in-LED-Indoor-Brushed-Nickel-Ceiling-Fan-with-SkyPlug-Technology-21243/304100217>, GE Savanna 5 in. LED Indoor Brushed nickel Ceiling Fan with SkyPlug Technology, Model No. 21243, accessed Jan. 4, 2018.
<https://www.lowes.com/pd/Harbor-Breeze-Mazon-44-in-Brush-Nickel-Integrated-LED-Indoor-Flush-Mount-Ceiling-Fan-with-Light-Kit-and-Remote-3-Blade/1000218321>, Harbor Breeze Mazon 44-in 3-Blade Brush Nickel LED Indoor Flush Mount Ceiling Fan with Light Kit and Remote, Model No. 00724, accessed Jan. 4, 2018.

* cited by examiner

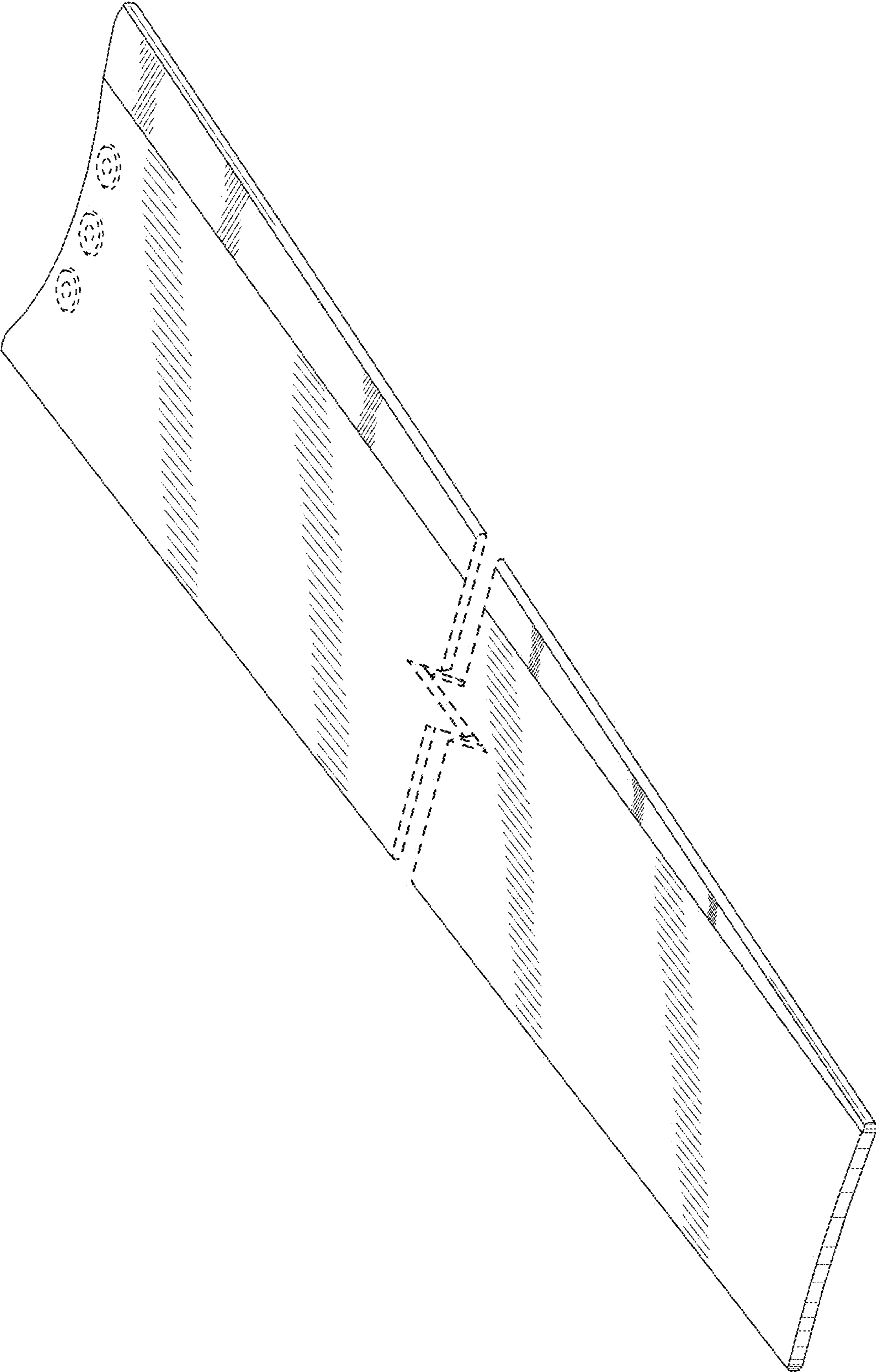

FIG. 1

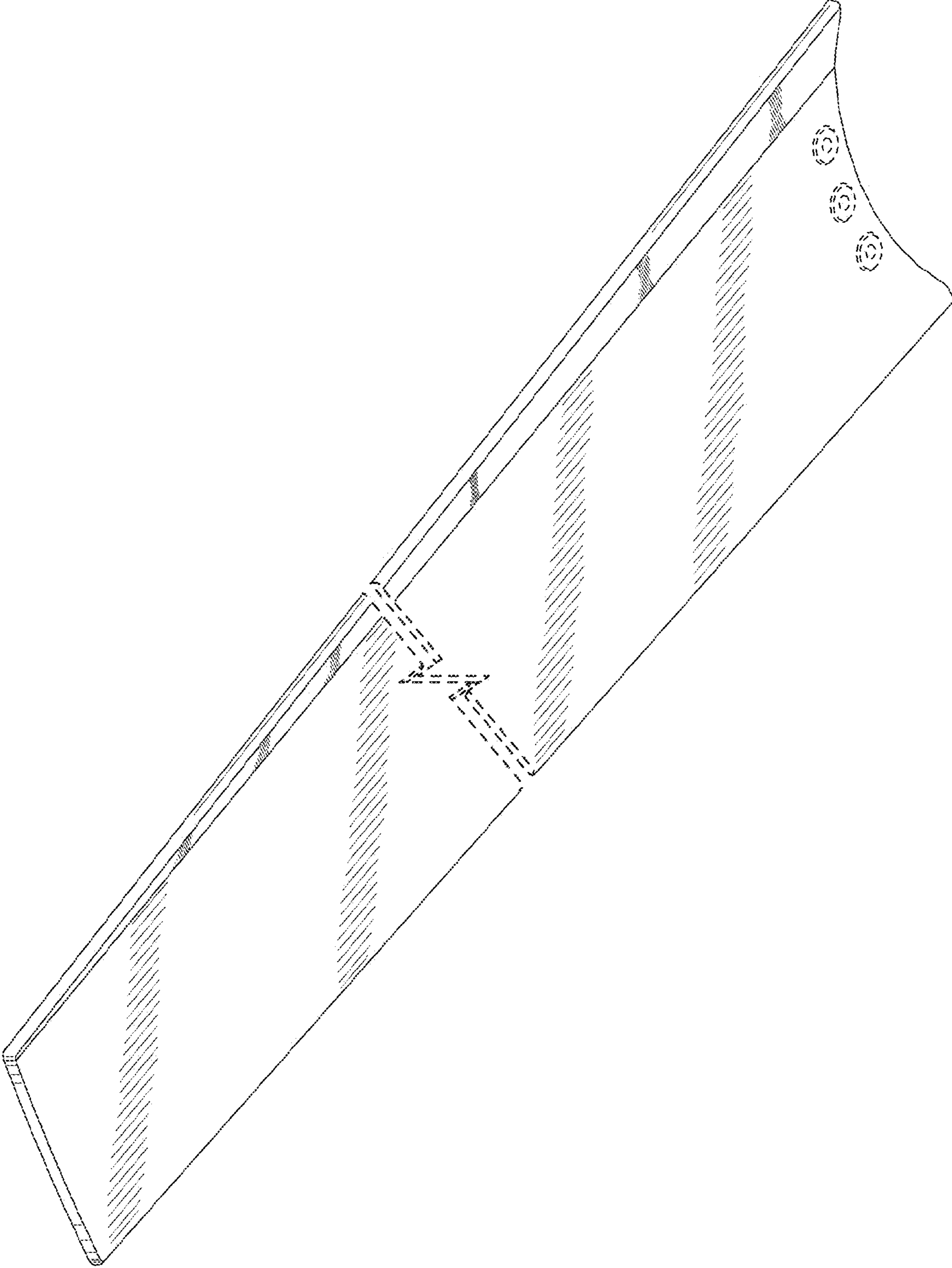

FIG. 2



FIG. 3



FIG. 4

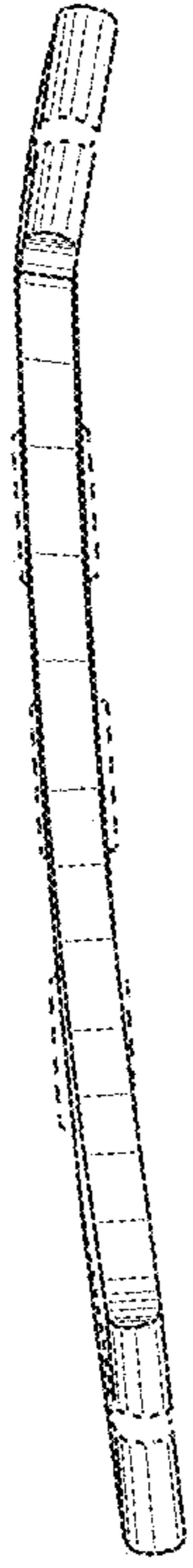

FIG. 5

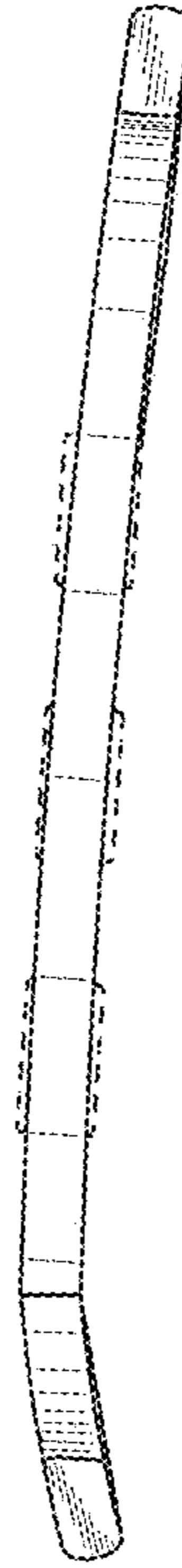

FIG. 6

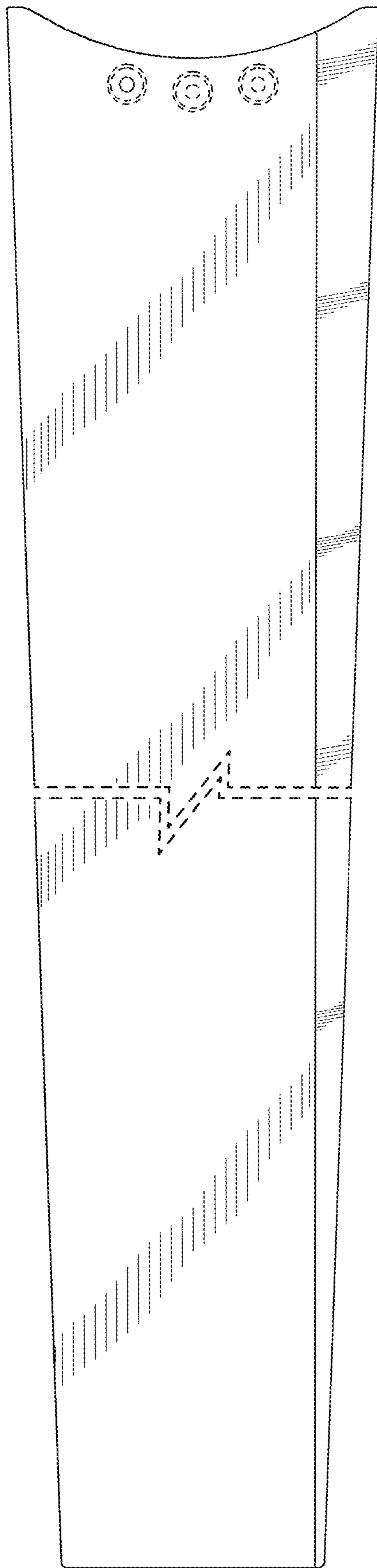

FIG. 7

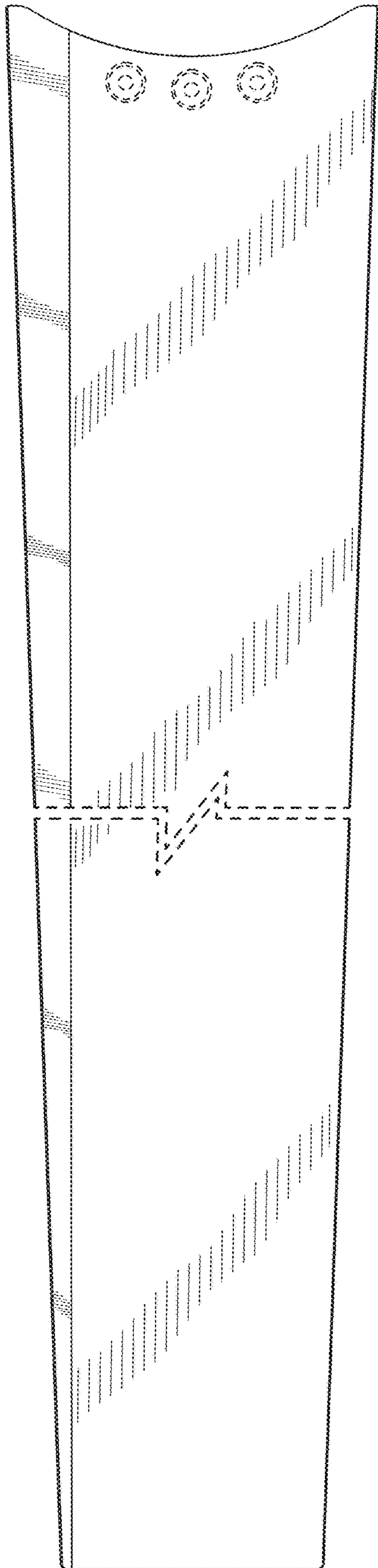

FIG. 8