



US00D902367S

(12) **United States Design Patent** (10) **Patent No.:** **US D902,367 S**
Findling (45) **Date of Patent:** **** Nov. 17, 2020**

(54) **WATER PIPE**
(71) Applicant: **Keith Findling**, Salt Lake City, UT (US)
(72) Inventor: **Keith Findling**, Salt Lake City, UT (US)
(**) Term: **15 Years**
(21) Appl. No.: **29/663,096**
(22) Filed: **Sep. 12, 2018**
(51) **LOC (12) Cl.** **23-04**
(52) **U.S. Cl.**
USPC **D23/359**
(58) **Field of Classification Search**
USPC D23/355-366, 352, 369, 332, 333, 335, D23/336, 342, 351; 422/120, 122; 55/356, 473, 504; 96/971; 261/DIG. 17, 261/DIG. 65, DIG. 88, DIG. 31; D27/162
CPC ... B08B 17/02; A61L 9/16; A61L 9/22; B01D 47/00; B01D 47/027; B01D 2221/02; B01D 2259/4508; B03C 3/155; B03C 3/368; F24F 3/16; F24F 13/20; F24F 13/28
See application file for complete search history.

D561,318 S * 2/2008 Naksen D23/366
D578,193 S * 10/2008 Lo D23/332
D615,639 S * 5/2010 Ouyang D23/332
D645,200 S * 9/2011 Desvall D27/162
9,955,722 B2 * 5/2018 Reyes A24F 1/32
D831,269 S * 10/2018 Qiu D27/162
D863,671 S * 10/2019 Reimann D27/162
D874,717 S * 2/2020 Nhep D27/162
D877,974 S * 3/2020 Tucci D27/162
D879,370 S * 3/2020 Aznavour D27/162

* cited by examiner

Primary Examiner — David G Muller
(74) *Attorney, Agent, or Firm* — David A. Jones; Nadesan Beck P.C.

(57) **CLAIM**
The ornamental design of a water pipe, substantially as shown and described.

DESCRIPTION
FIG. 1 is a front perspective view of a water pipe in accordance with the present invention;
FIG. 2 is a rear perspective view thereof;
FIG. 3 is a right view thereof;
FIG. 4 is a top view thereof;
FIG. 5 is a left view thereof;
FIG. 6 is a bottom view thereof;
FIG. 7 is a rear view thereof; and,
FIG. 8 is a front view thereof.
The features shown in broken lines in the various Figures are for illustrating environmental structure and form no part of the claimed design. The article is not limited to the scale shown herein.

(56) **References Cited**
U.S. PATENT DOCUMENTS
4,111,214 A * 9/1978 Flesher A24F 1/30 131/173
D258,013 S * 1/1981 Murphy D27/162
D549,313 S * 8/2007 Kelnhofer D23/360

1 Claim, 4 Drawing Sheets

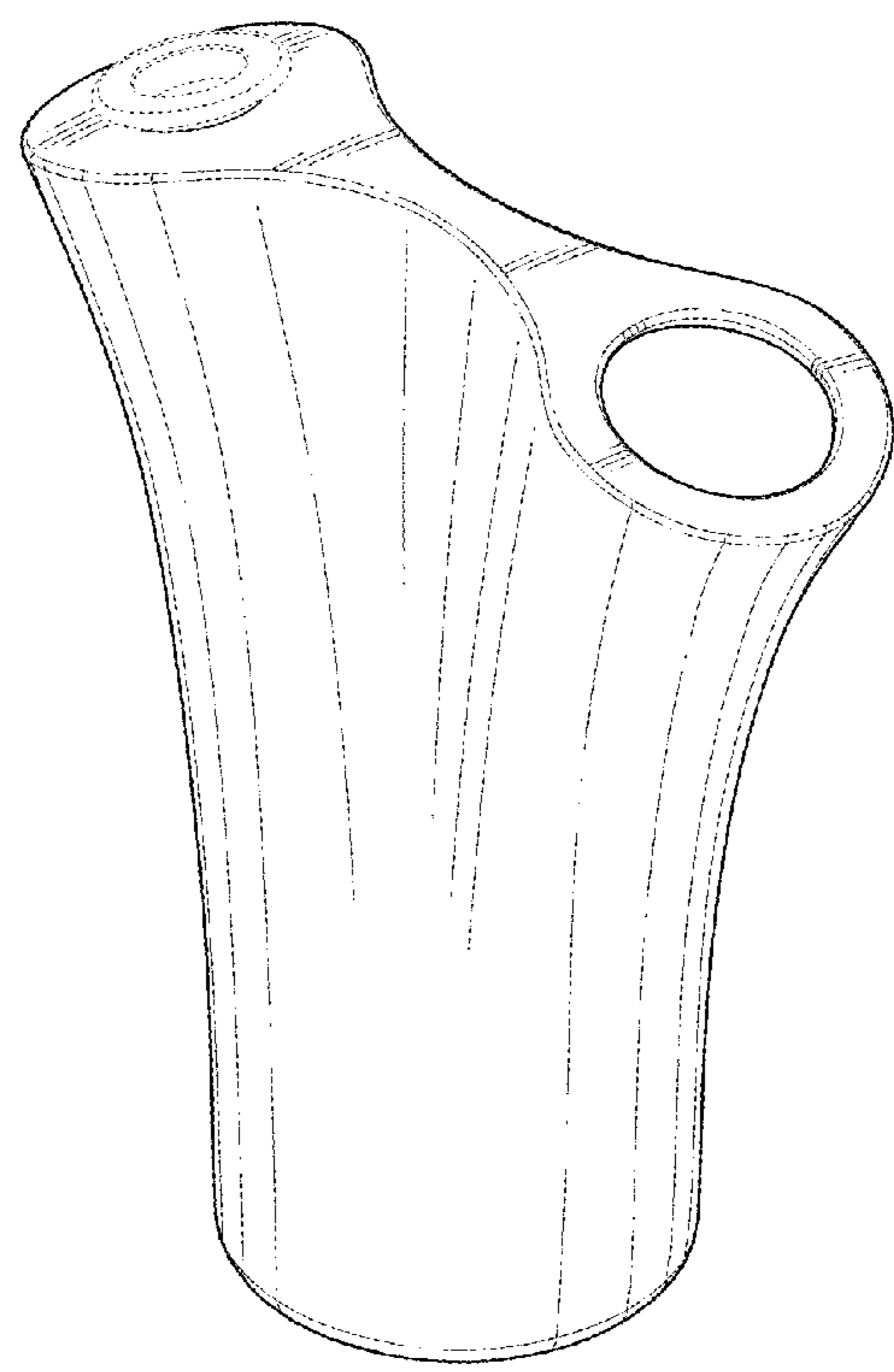

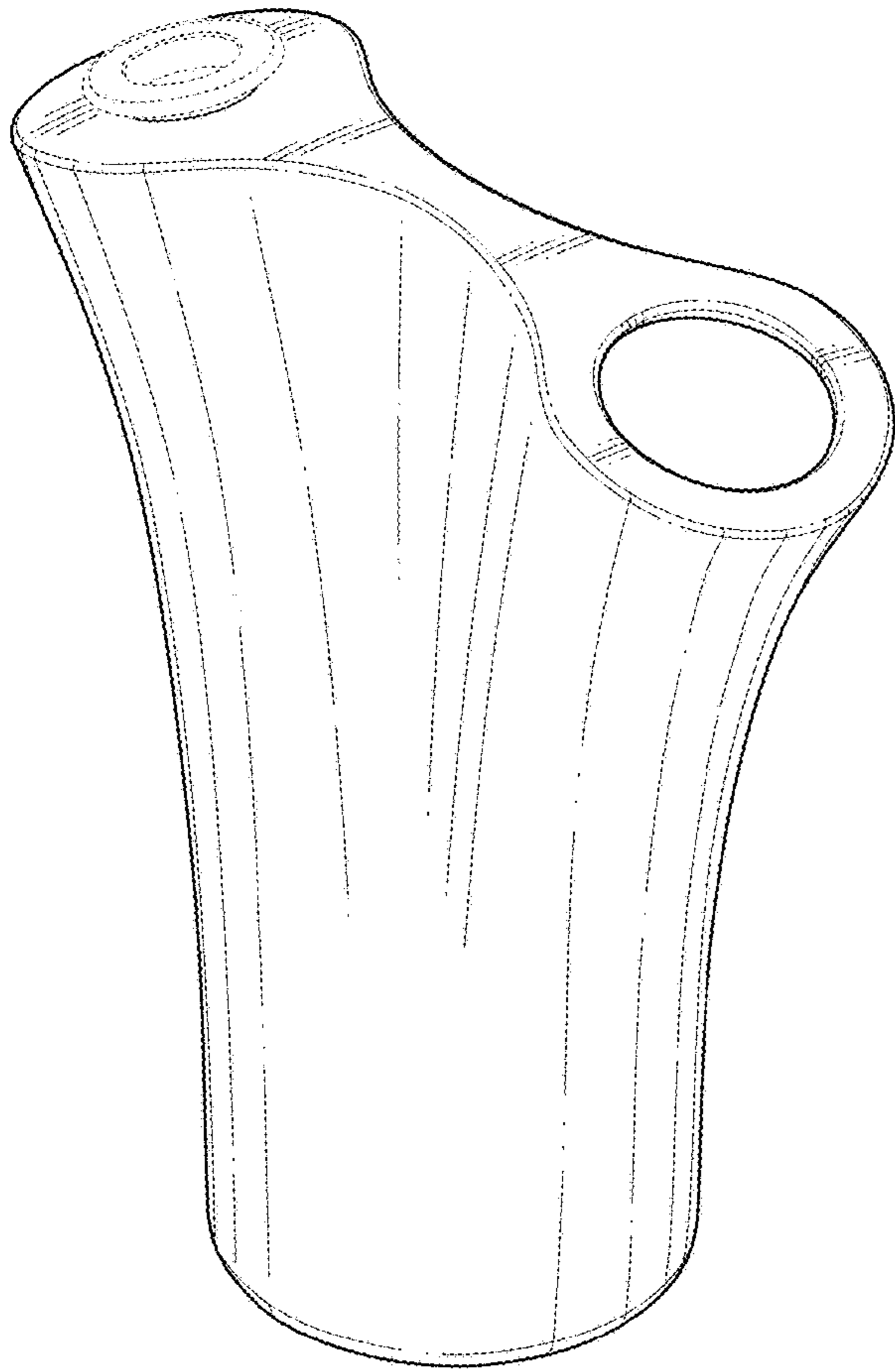

FIG. 1

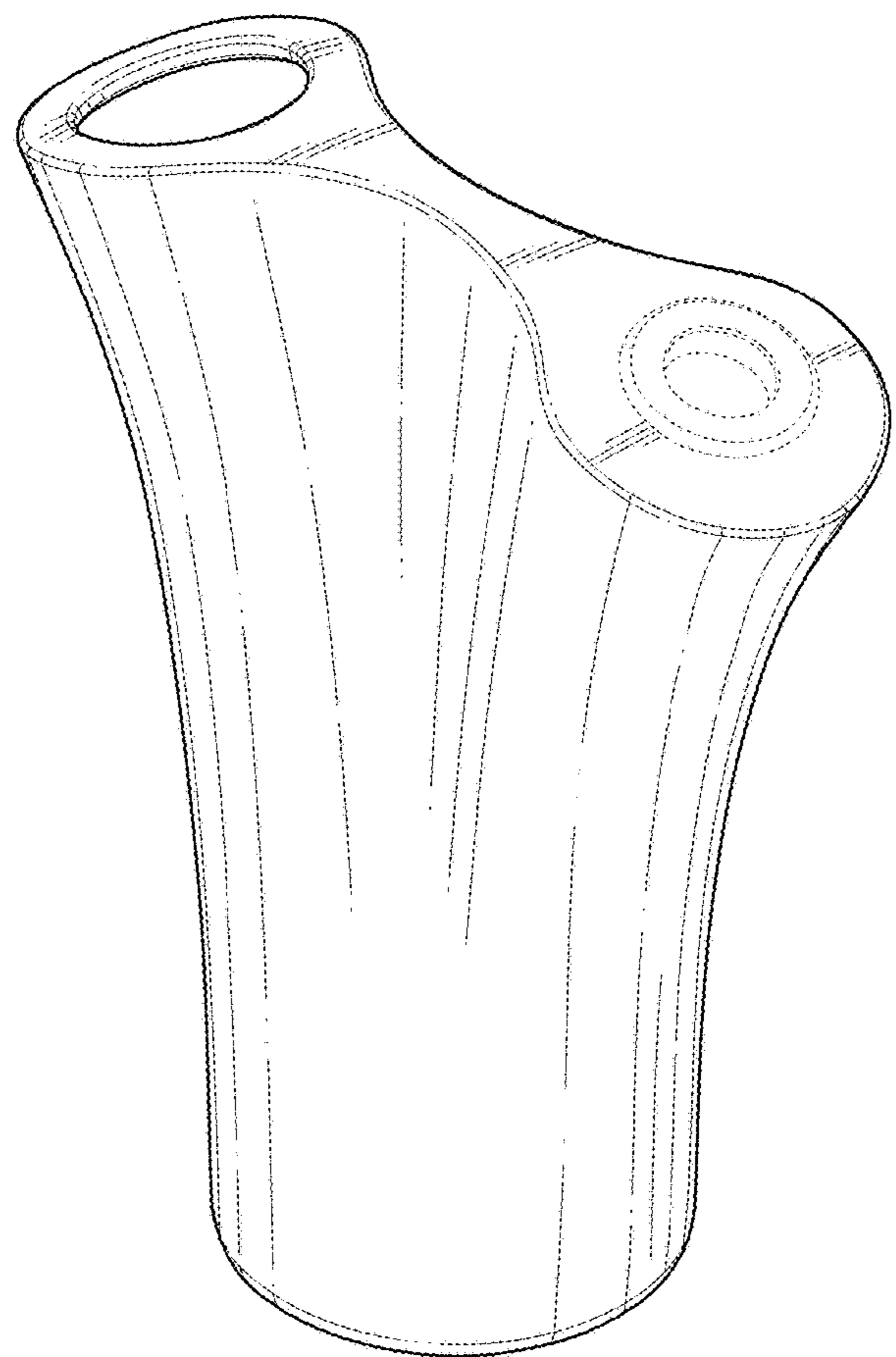

FIG. 2

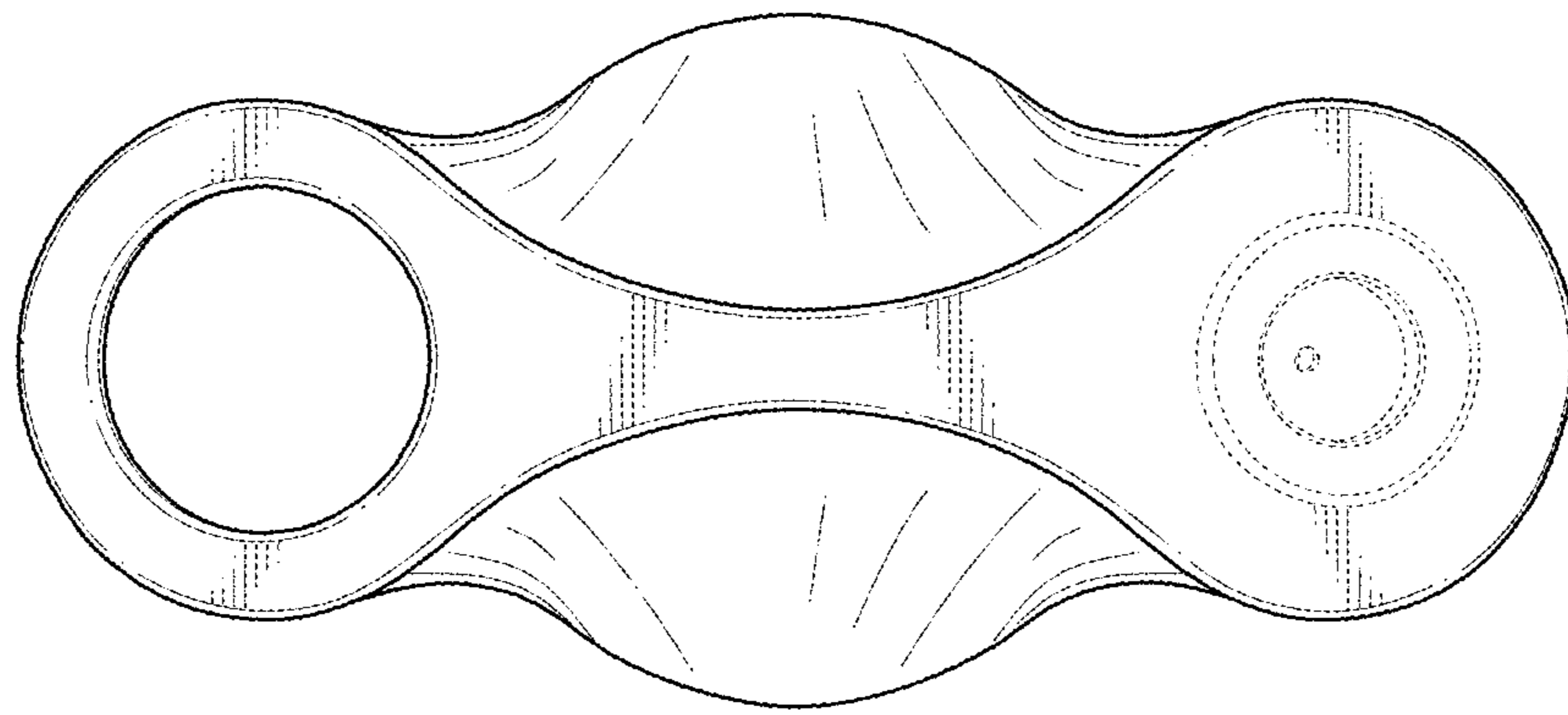

FIG. 4

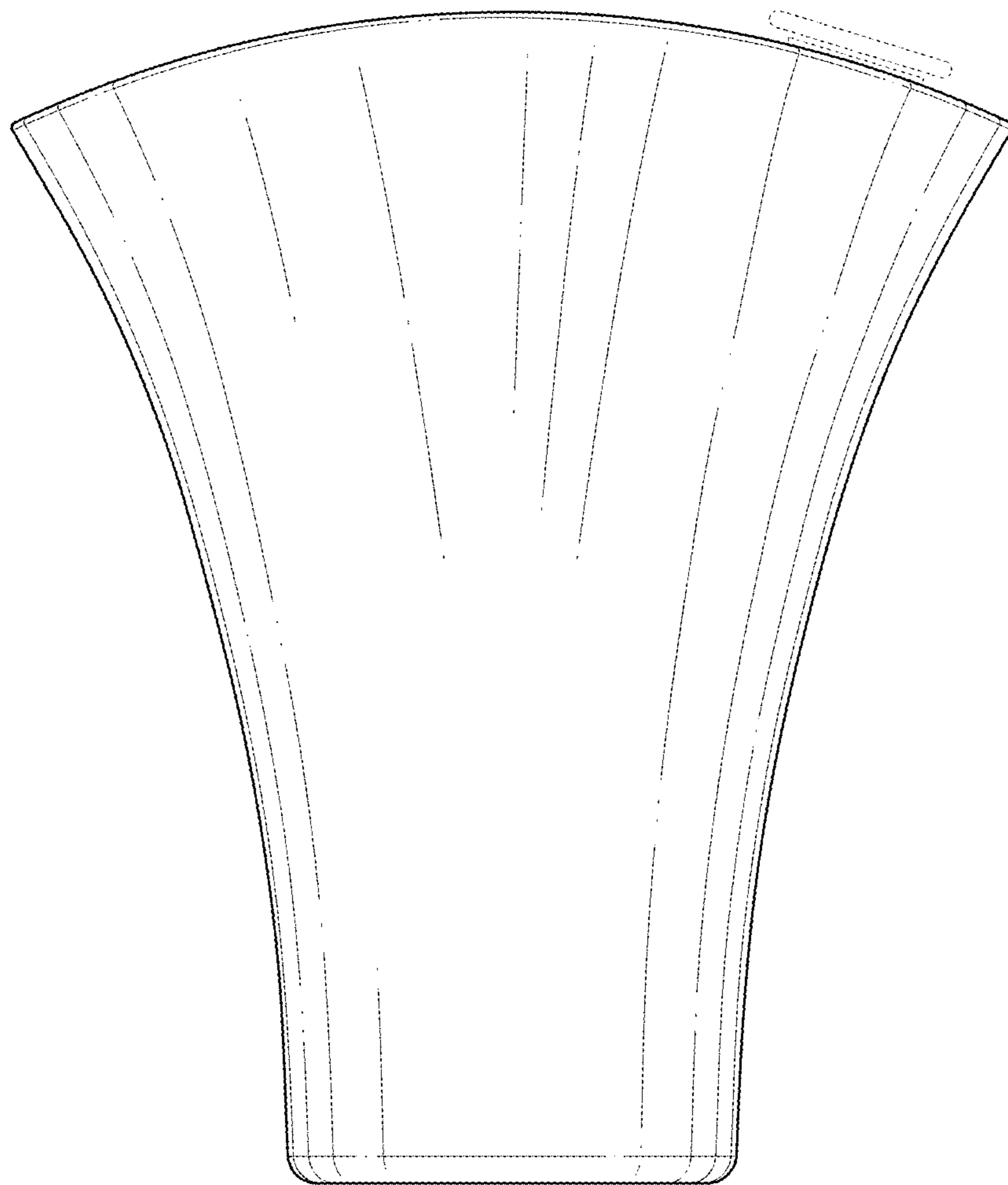

FIG. 3

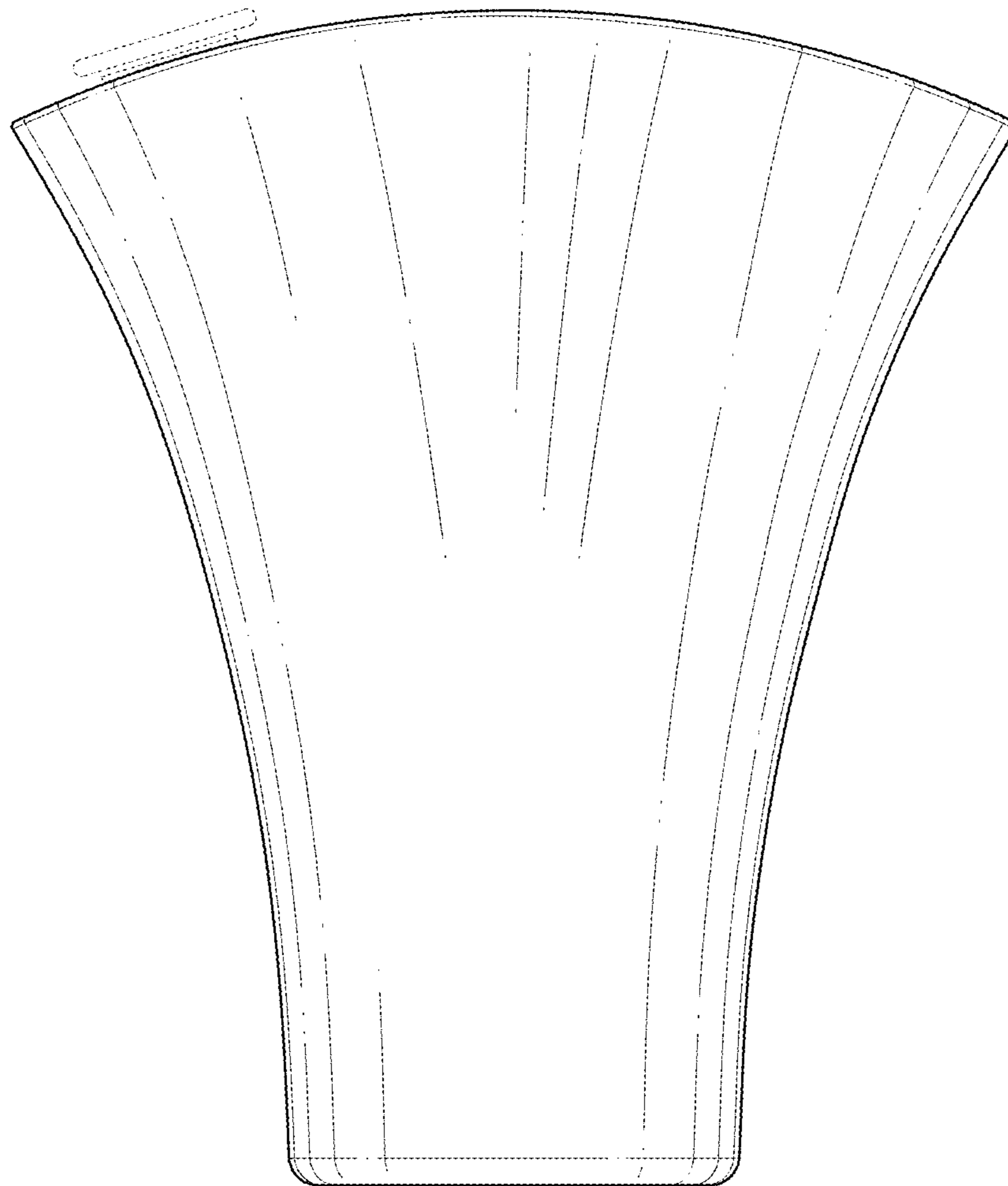

FIG. 5

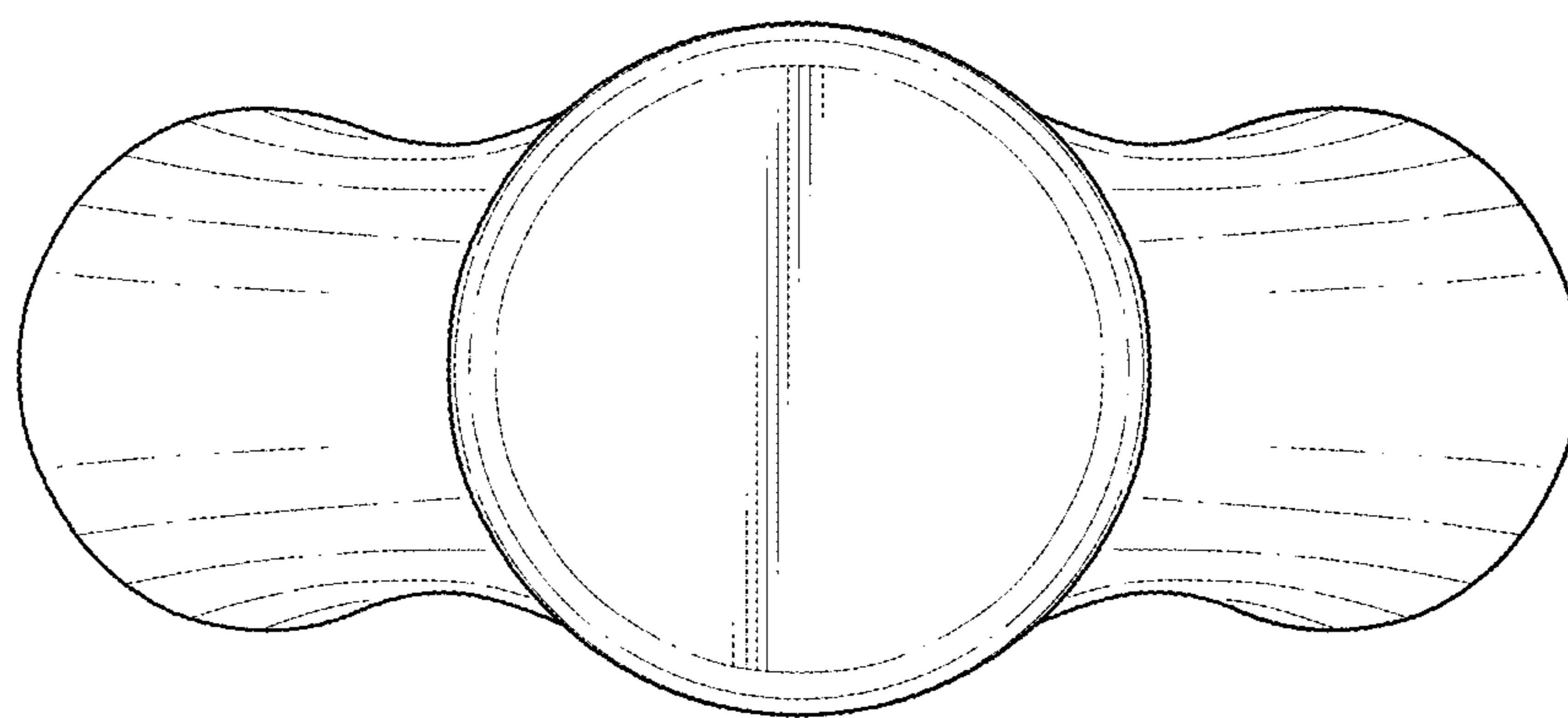

FIG. 6

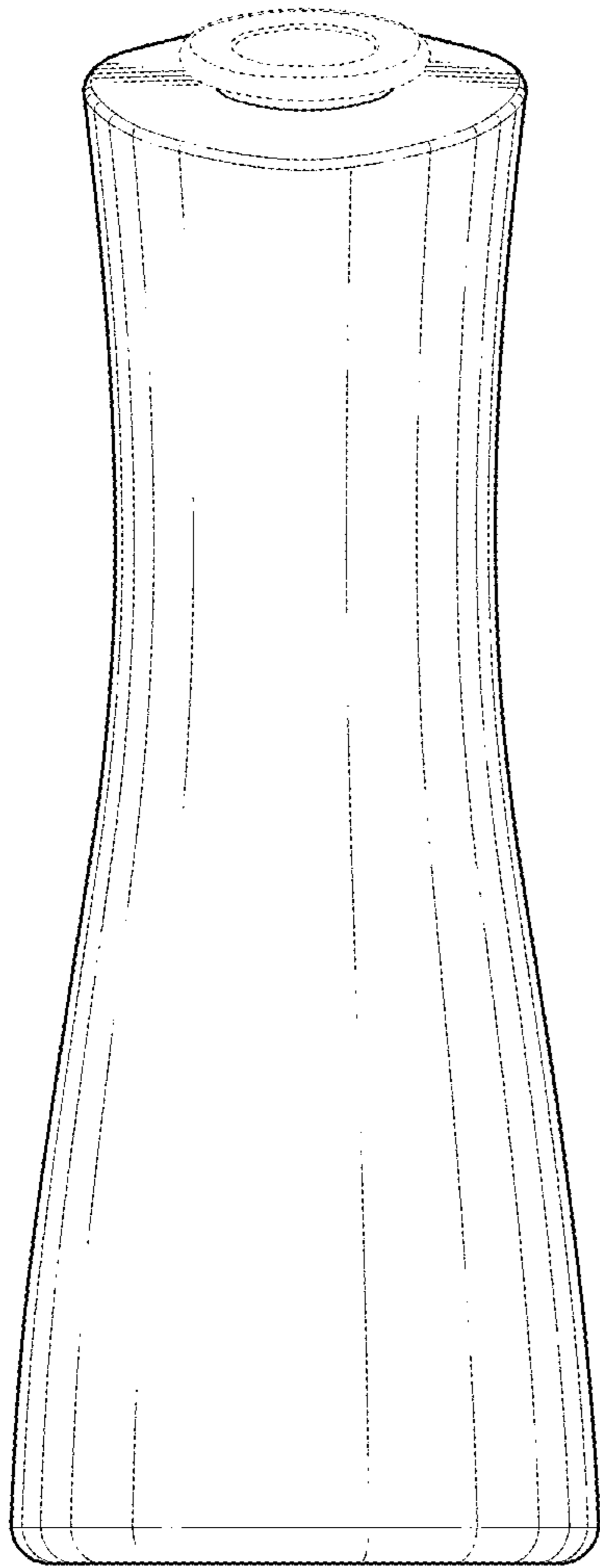

FIG. 7

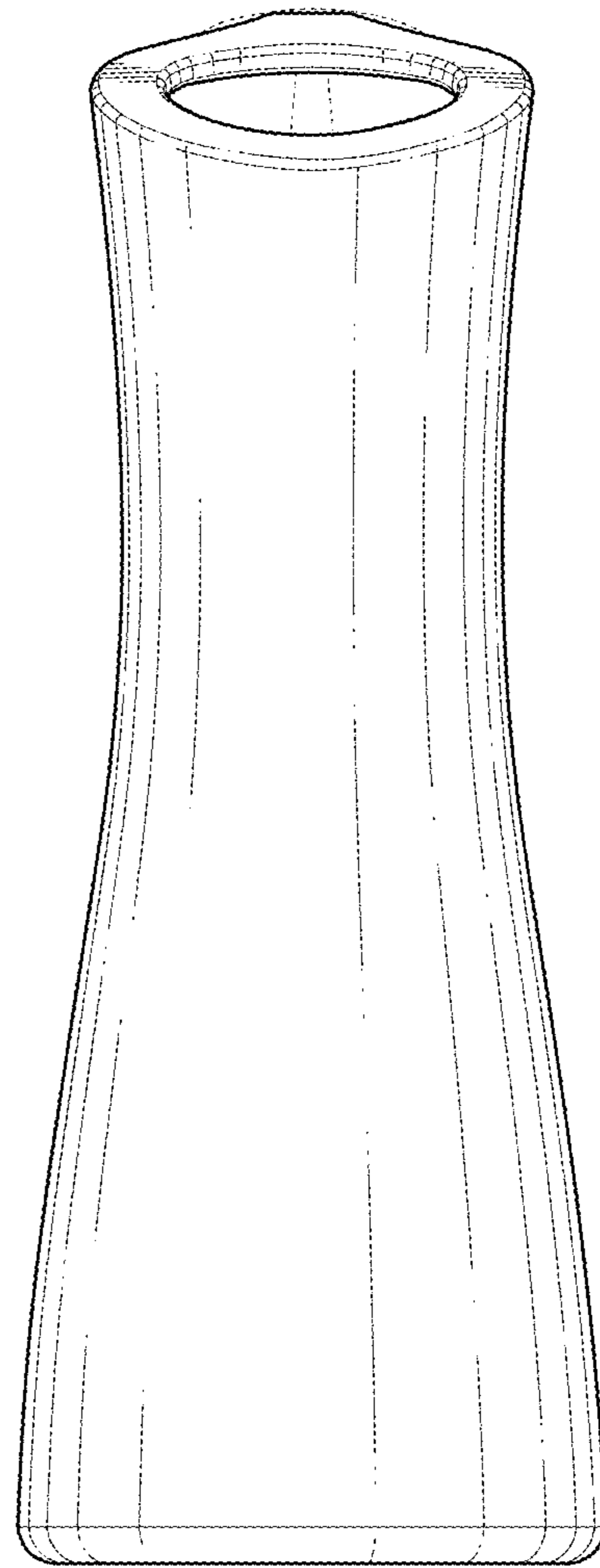

FIG. 8