



US00D902285S

(12) **United States Design Patent** (10) **Patent No.:** **US D902,285 S**
Persson et al. (45) **Date of Patent:** **** Nov. 17, 2020**

(54) **CAMERA**

(71) Applicant: **Axis AB**, Lund (SE)

(72) Inventors: **Henrik Persson**, Lund (SE); **Mathias Walter**, Lund (SE); **Daniel Åhman**, Lund (SE)

(73) Assignee: **AXIS AB**, Lund (SE)

(**) Term: **15 Years**

(21) Appl. No.: **29/714,517**

(22) Filed: **Nov. 23, 2019**

Related U.S. Application Data

(62) Division of application No. 29/654,481, filed on Jun. 25, 2018, now Pat. No. Des. 881,968.

(30) **Foreign Application Priority Data**

Jan. 15, 2018 (EM) 004666527-0001
Jan. 15, 2018 (EM) 004666527-0003
Jan. 15, 2018 (EM) 004666527-0004

(51) **LOC (12) Cl.** **16-01**

(52) **U.S. Cl.**
USPC **D16/219; D16/203**

(58) **Field of Classification Search**
USPC D16/200–220, 131, 237, 242, 239, 250,
D16/235, 130, 134, 136, 238;
D14/138 C, 240, 248, 203.1, 203.3, 203.7,
D14/218, 207; D10/104.1, 50, 65, 74,
D10/70, 118.2, 106.6, 106.8; D6/542,
D6/545
CPC . G02B 7/02; G02B 7/021; G02B 7/04; G02B
7/14; G02B 7/003; G03B 17/00; G03B
17/02; G03B 17/56; G03B 17/04;

(Continued)

(56) **References Cited**

U.S. PATENT DOCUMENTS

D452,696 S ‡ 1/2002 Fenton D16/203
D519,662 S * 4/2006 Mullen D26/61

(Continued)

FOREIGN PATENT DOCUMENTS

CN 303467307 ‡ 11/2015
CN 304317979 ‡ 10/2017

(Continued)

OTHER PUBLICATIONS

AXIS Companion Bullet Mini LE—network surveillance camera, published 2019 [online], [retrieved Sep. 8, 2019], Available from Internet, URL: <https://www.cdw.com/product/axis-companion-bullet-mini-le-2mp/5173050>.

(Continued)

Primary Examiner — Dana K Wieland
Assistant Examiner — Mary Claire Ramirez
(74) *Attorney, Agent, or Firm* — Tucker Ellis LLP

(57) **CLAIM**

The ornamental design for a camera, as shown and described.

DESCRIPTION

FIG. 1 is a perspective view of a camera showing our new design;
FIG. 2 is a front view thereof;
FIG. 3 is a rear view thereof;
FIG. 4 is a right side view thereof;
FIG. 5 is a left side view thereof;
FIG. 6 is a top view thereof; and,
FIG. 7 is a bottom view thereof.
The broken lines are for the purpose of illustrating portions of the camera and form no part of the claimed design.

1 Claim, 7 Drawing Sheets

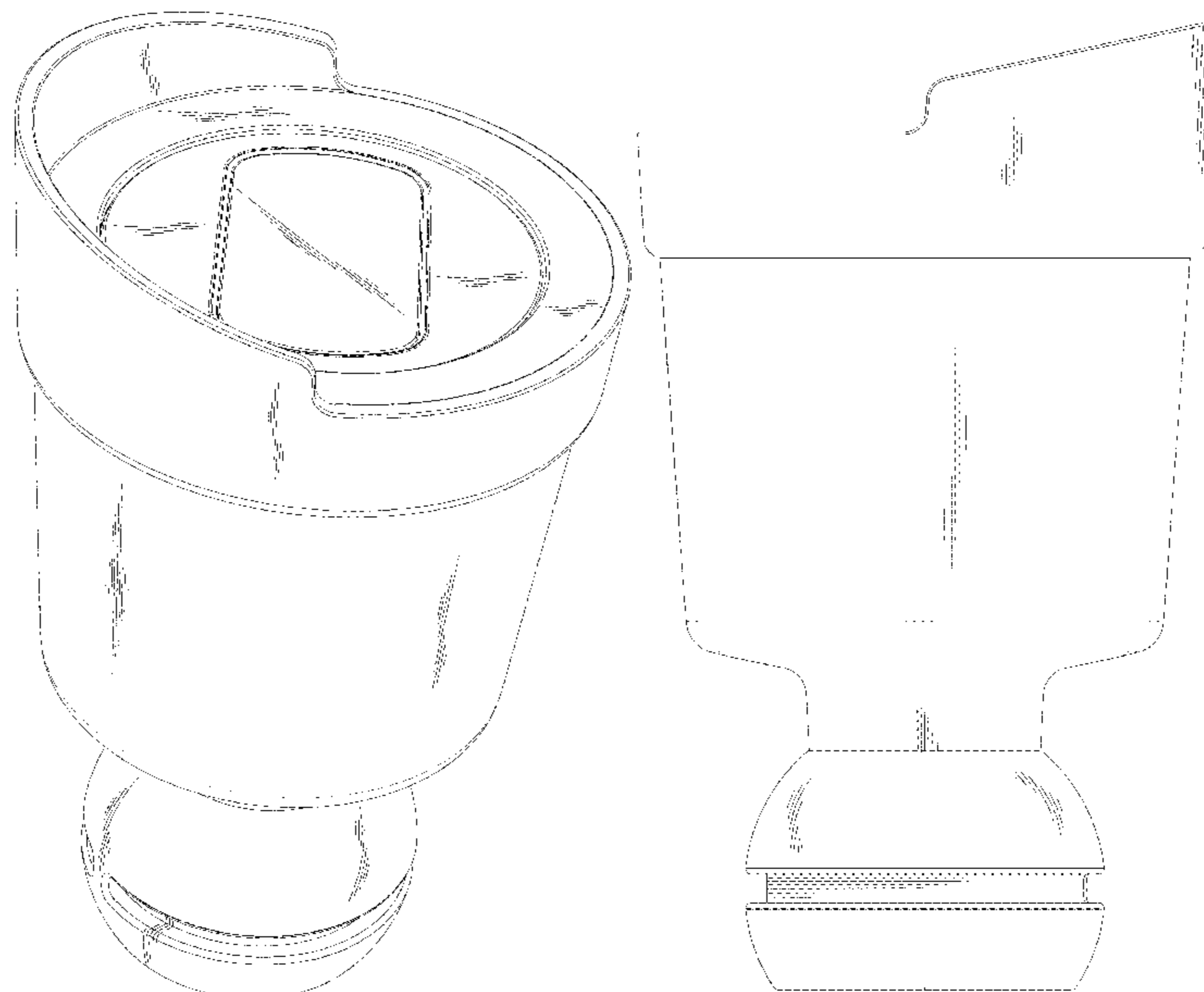

- (58) **Field of Classification Search**
 CPC G03B 17/14; G03B 17/08; G03B 15/03;
 G03B 15/06; H04N 5/2251; H04N
 5/2252; H04N 5/2253; H04N 5/2254;
 H04N 7/00; H04N 2101/00; F16M 13/00
 See application file for complete search history.

(56) **References Cited**

U.S. PATENT DOCUMENTS

D556,236	S	‡	11/2007	Kim	D16/202
D609,732	S	‡	2/2010	Frank	D16/203
D626,984	S	‡	11/2010	Miyaji	D16/202
D629,439	S	‡	12/2010	Yoshida	D16/203
D633,931	S	‡	3/2011	Ham	D16/203
D634,345	S	*	3/2011	Kim	D16/203
D634,347	S	*	3/2011	Park	D16/203
D634,768	S	*	3/2011	Ko	D16/203
D635,172	S	*	3/2011	Ko	D16/203
D637,640	S	*	5/2011	Park	D16/203
D639,842	S	‡	6/2011	Zeinoun	D16/203
D642,607	S	*	8/2011	Bergstrom	D16/203
D643,453	S	*	8/2011	Ham	D16/203
D643,454	S	*	8/2011	Zaliauskas	D16/202
D653,687	S	‡	2/2012	Yu	D16/200
D657,410	S	‡	4/2012	Helaoui	D16/203
D676,477	S	‡	2/2013	Chen	D16/202
D691,187	S	*	10/2013	Seo	D16/203
D702,274	S	*	4/2014	Qian	D16/203
D707,743	S	*	6/2014	Nakashima	D16/202
D721,755	S	‡	1/2015	Ahman	D16/203
D721,756	S	*	1/2015	Hallstrom	D16/203
D723,603	S	*	3/2015	Hess, Jr.	D16/203
9,004,785	B1	*	4/2015	Mohan G03B 17/561	348/143
D731,574	S	*	6/2015	Hallstrom	D16/203
D740,874	S	‡	10/2015	Ahman	D16/203
D741,933	S	*	10/2015	Bergstrom	D16/203
D741,934	S	‡	10/2015	Stark	D16/203
D743,465	S	‡	11/2015	Aglassinger	D16/203
D743,467	S	*	11/2015	Bhattacharya	D16/203
D745,911	S	‡	12/2015	Lee	D16/203
D748,710	S	*	2/2016	Bergstrom	D16/203
D749,662	S	‡	2/2016	Chen	D16/203
D752,675	S	‡	3/2016	Ravat	D16/203
D752,676	S	‡	3/2016	Ravat	D16/203
D753,751	S	*	4/2016	Moller-Lewin	D16/203
D756,437	S	‡	5/2016	Bennermark	D16/203
D783,076	S	‡	4/2017	Ravat	D16/203
D787,581	S	*	5/2017	Moller-Lewin	D16/203
D809,048	S	‡	1/2018	Andersson	D16/203
D812,670	S	*	3/2018	Andersson	D16/203
D813,926	S	‡	3/2018	Shin	D16/203
D816,143	S	*	4/2018	Ahman	D16/203
RE46,822	E	*	5/2018	Moller-Lewin H04N 7/18	D16/203
D816,755	S	‡	5/2018	Barnekow	D16/203
D817,378	S	‡	5/2018	Persson	D16/203
D820,896	S	*	6/2018	Novak	D16/203
D821,477	S	*	6/2018	Moon	D16/203
D823,369	S	*	7/2018	Wang	D16/203
D823,919	S	‡	7/2018	Persson	D16/203

D829,802	S	*	10/2018	Park	D16/203
D837,863	S	‡	1/2019	Persson	D16/203
D839,337	S	*	1/2019	Novak	D16/203
D839,338	S	‡	1/2019	Persson	D16/203
D848,503	S	*	5/2019	Ahman	D16/203
D848,514	S	‡	5/2019	Ahman	D61/219
D849,120	S	‡	5/2019	Ahman	D16/219
D855,584	S	*	8/2019	Laine	D14/216
D856,397	S	‡	8/2019	Ahman	D16/219
D857,078	S	*	8/2019	Xue	D16/203
D857,777	S	*	8/2019	Rosenkvist	D16/203
D866,637	S	*	11/2019	Xie	D16/203
D875,103	S	*	2/2020	Vogel	D14/447
D881,968	S	*	4/2020	Persson	D16/203
D884,770	S	*	5/2020	Xue	D16/203
D895,711	S	*	9/2020	Hou	D16/200
2006/0045499	A1	*	3/2006	Cheng G03B 17/08	396/25
2011/0090350	A1	‡	4/2011	Oomori H04N 5/2252	348/207.99
2012/0106943	A1	‡	5/2012	Mukai G03B 37/00	396/427
2013/0287385	A1	‡	10/2013	Andersson H04N 5/2252	396/427
2015/0358511	A1	*	12/2015	Jung H04N 5/2252	348/143
2016/0026070	A1	*	1/2016	Holbrook H04N 5/2256	396/535
2016/0112608	A1	‡	4/2016	Elensi H04N 5/2252	348/143
2017/0171436	A1	*	6/2017	Fagerkvist F16C 11/10	
2017/0269460	A1	*	9/2017	Fagerkvist F16C 11/06	
2017/0337789	A1	*	11/2017	Rosenkvist G03B 17/561	
2017/0353635	A1	‡	12/2017	Shin H04N 7/18	
2017/0357146	A1	*	12/2017	Parisi G03B 17/561	
2018/0165932	A1	‡	6/2018	Larsson G08B 13/19619	
2019/0191059	A1	‡	6/2019	Park H04N 5/2251	

FOREIGN PATENT DOCUMENTS

EM	001358469-0002	‡	1/2013
EM	003029412-0001	‡	3/2016
EM	003110238-0001	‡	5/2016
TW	D185814	‡	10/2017
TW	D189320	‡	3/2018
TW	D190812	‡	6/2018

OTHER PUBLICATIONS

Sep. 2017 AXIS products, published Sep. 9, 2017 [online], [retrieved Sep. 8, 2019], Available from Internet, URL: <https://www.camcentral.net/2017/09/09/september-2017-new-axis-products/>.
 Axis Companion Bullet Mini Le—network surveillance camera, published 2019 [online], [retrieved Sep. 8, 2019], Available from Internet, URL: www.cdw.com/product/axis-companion-bullet-mini-le-2mp/5173050.
 Sep. 2017 AXIS products, published Sep. 9, 2019 [online], [retrieved Sep. 8, 2019], Available from Internet, URL: <https://www.camcentral.net/2017/09/09/september-2017-new-axis-products/>.

* cited by examiner

‡ imported from a related application

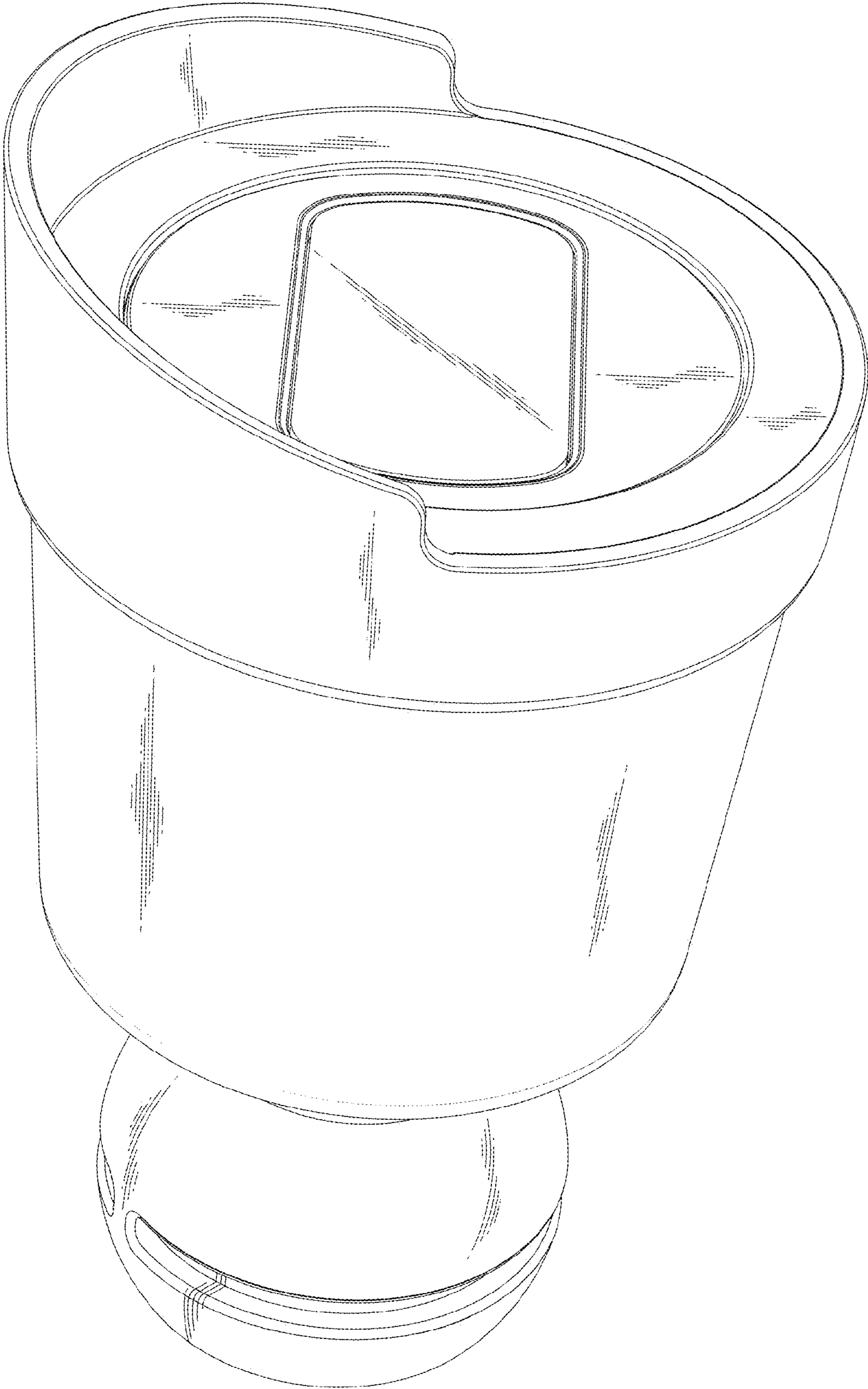

FIG. 1

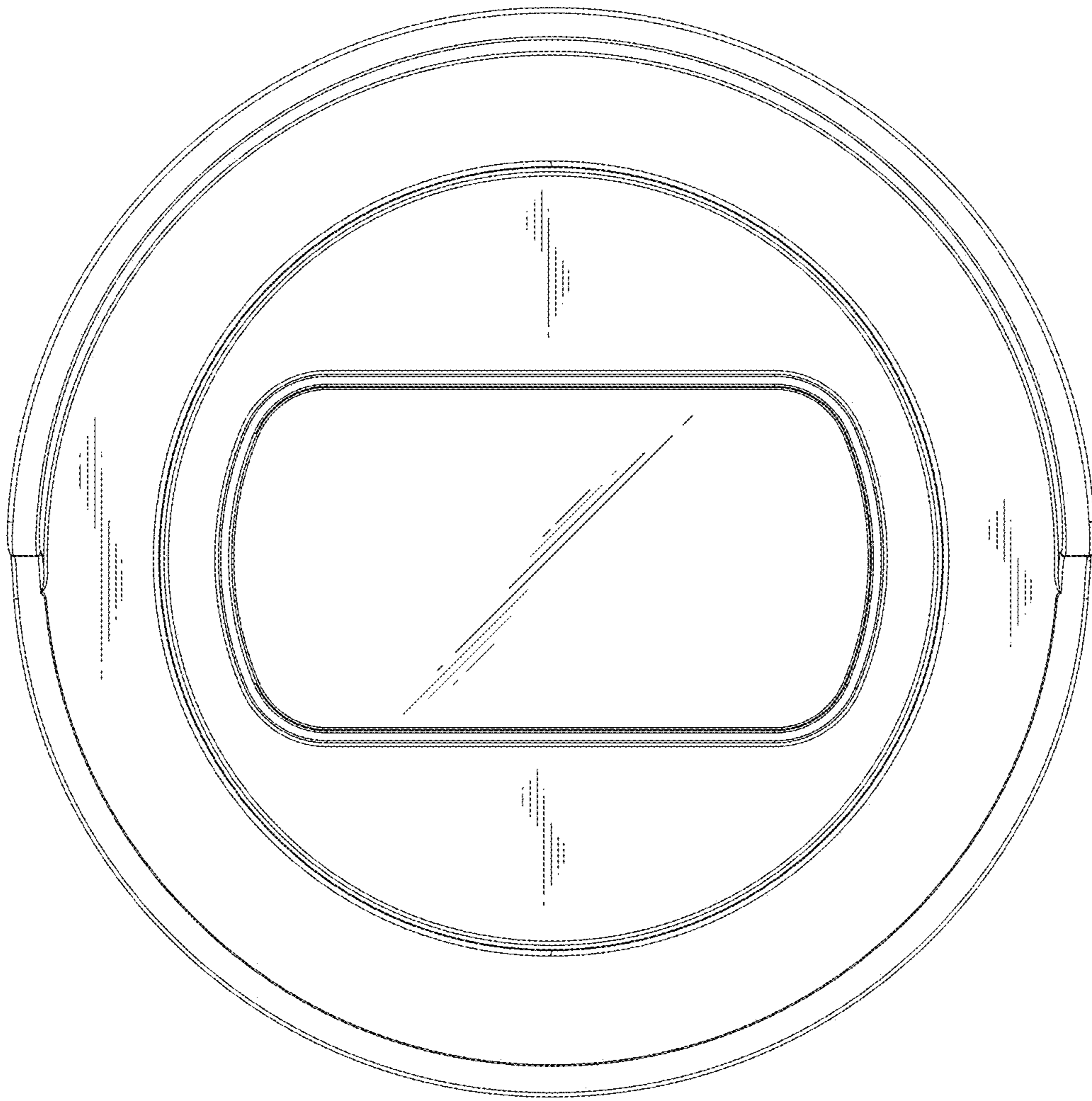

FIG. 2

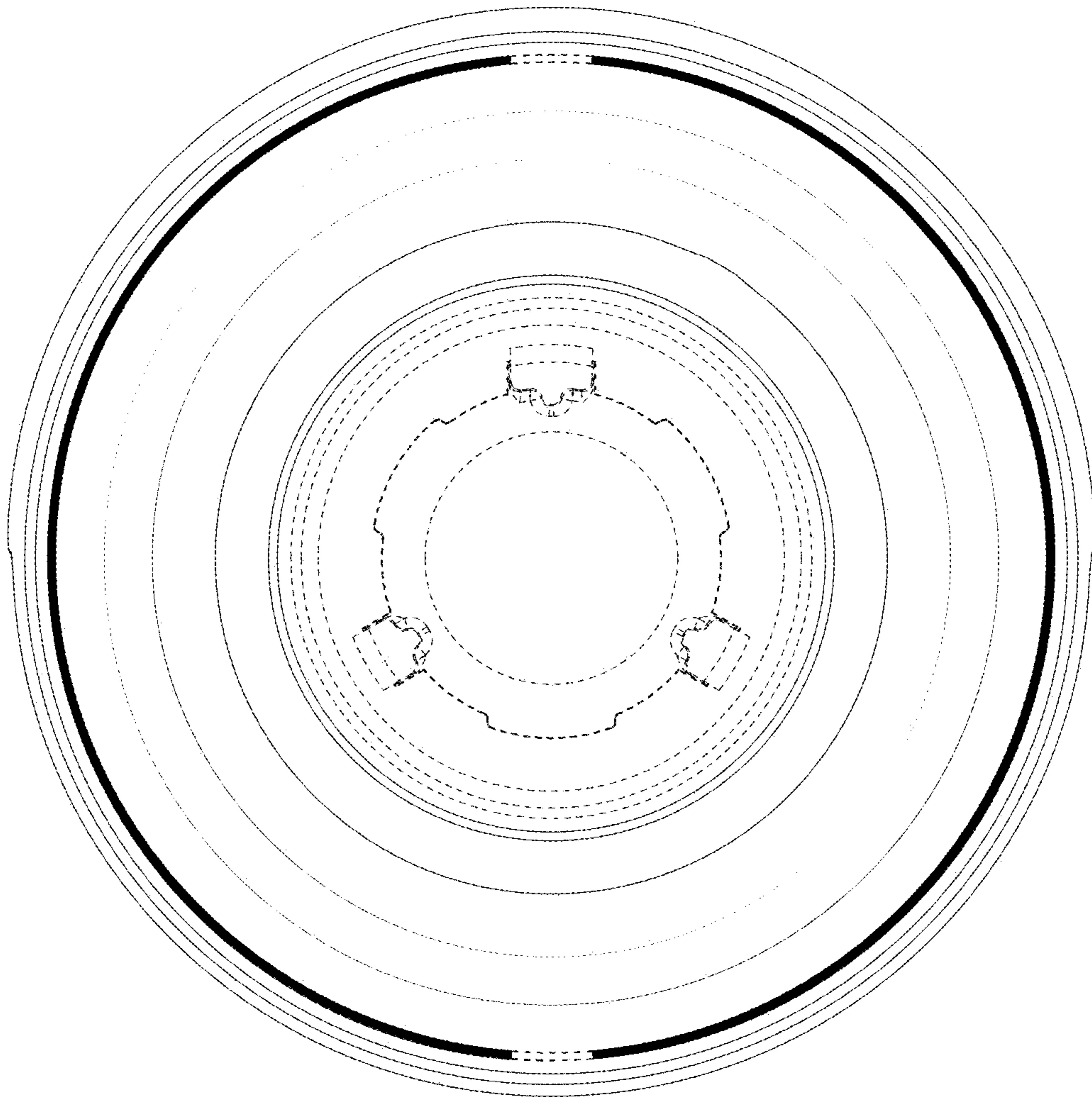

FIG. 3

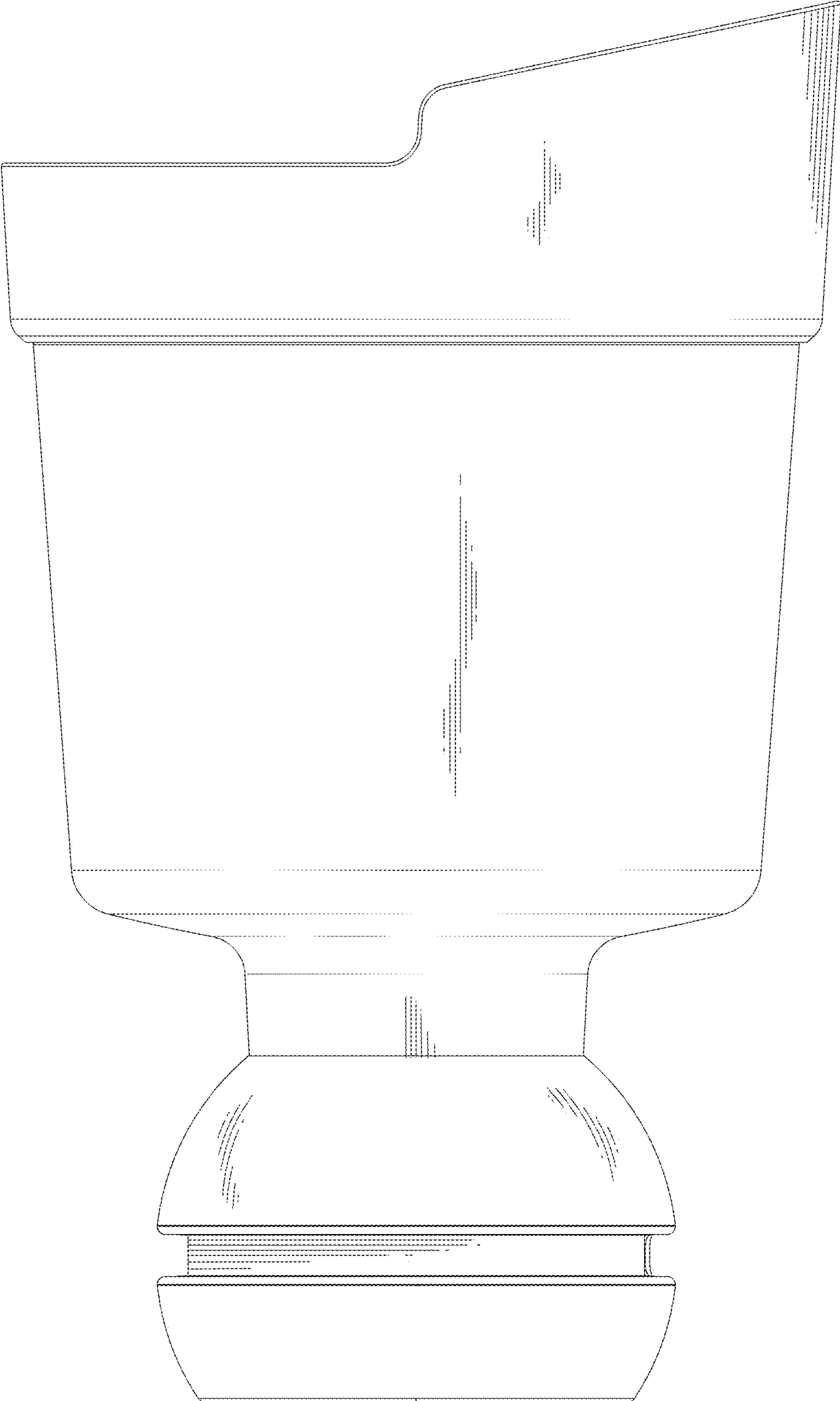

FIG. 4

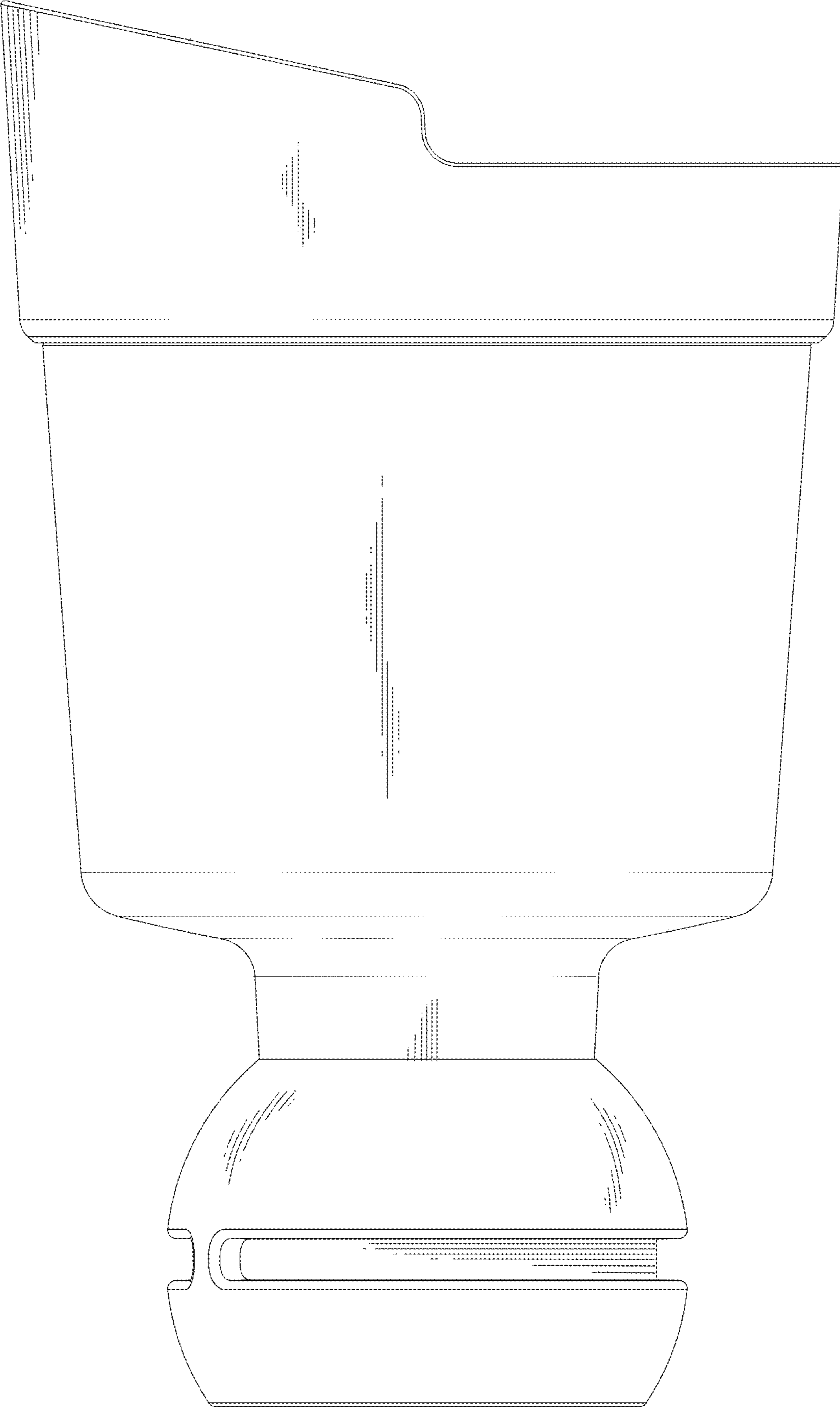

FIG. 5

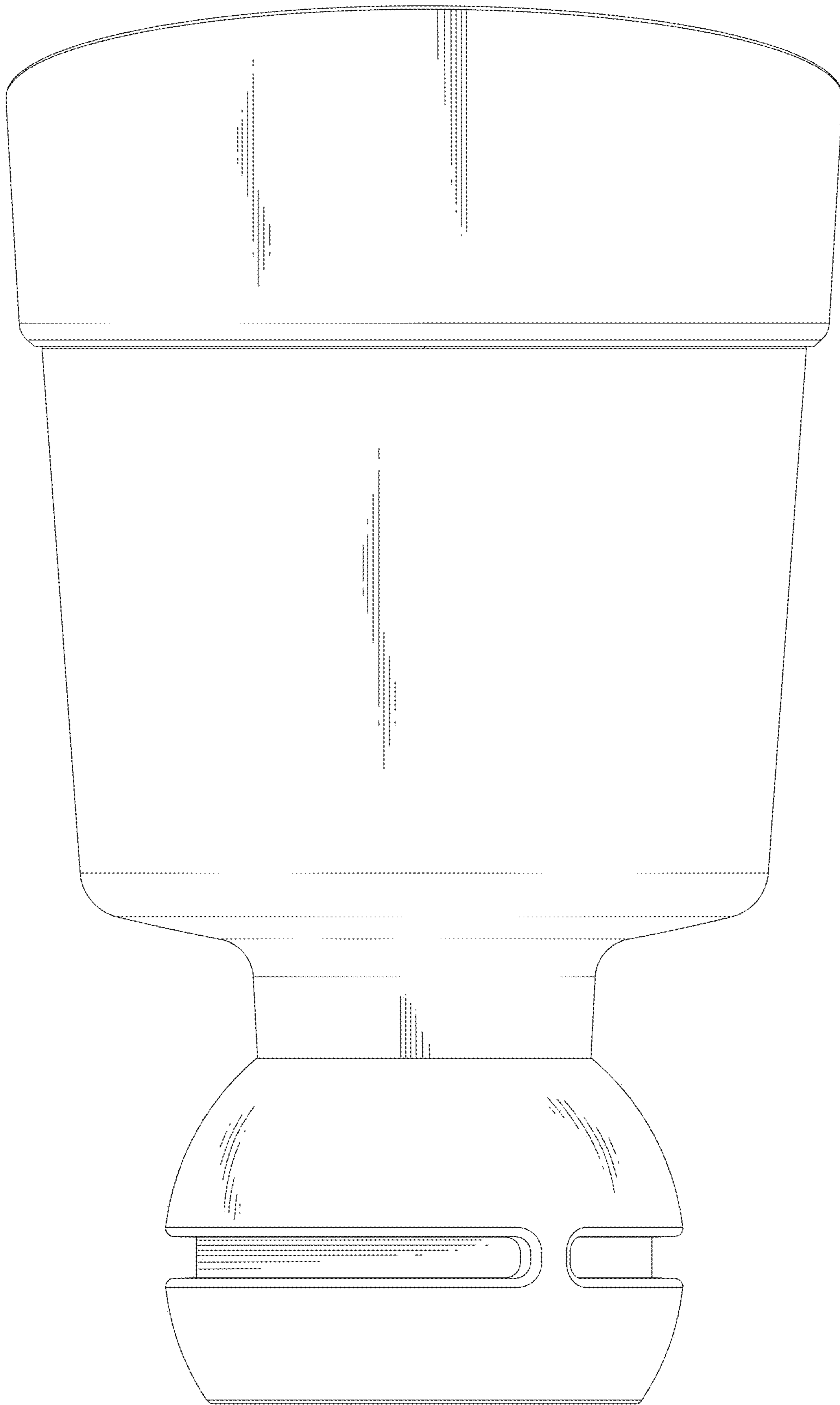

FIG. 6

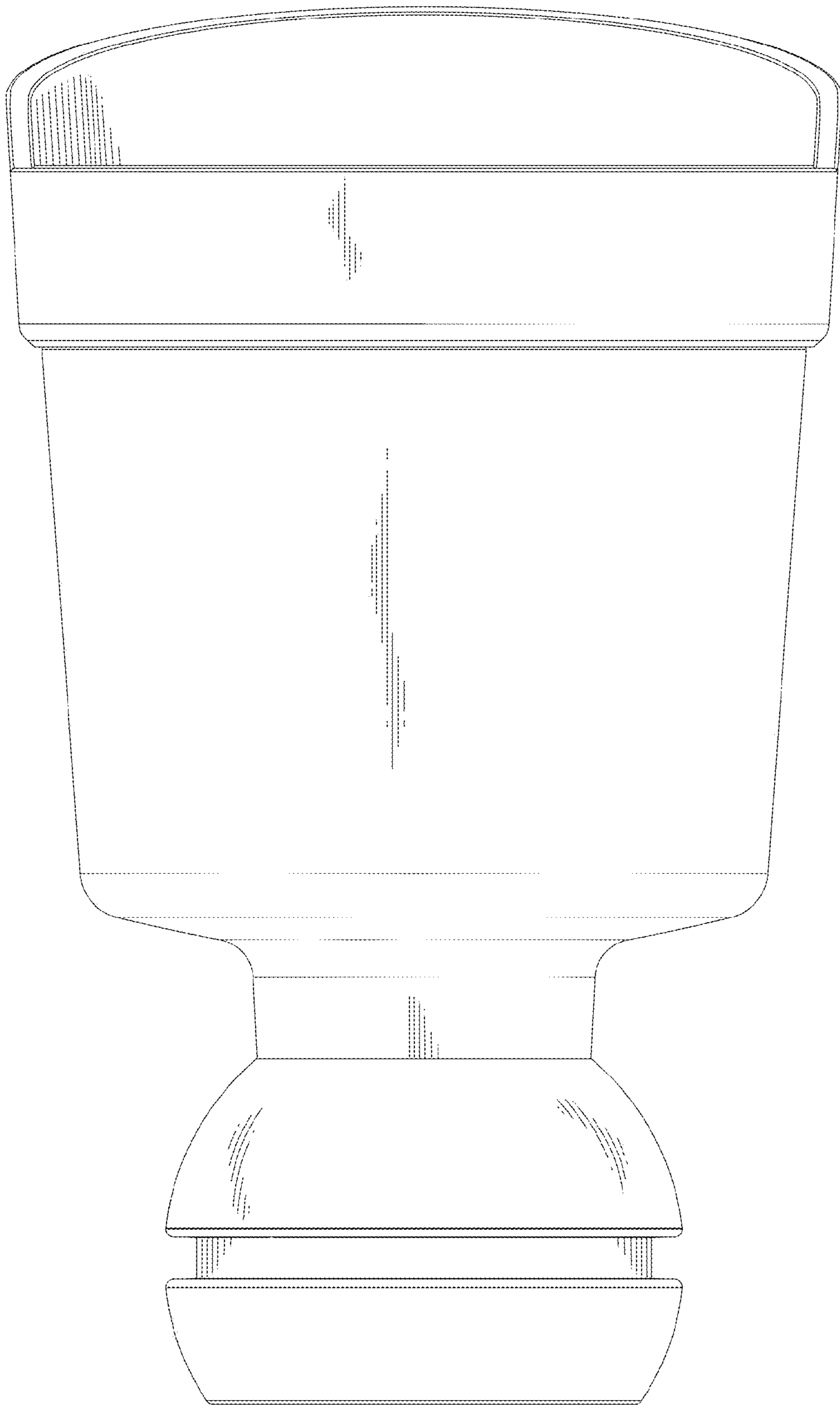

FIG. 7