



US00D902185S

(12) **United States Design Patent**
Xian

(10) **Patent No.:** **US D902,185 S**

(45) **Date of Patent:** **** Nov. 17, 2020**

(54) **WIRELESS EARBUD**

(71) Applicant: **Guimei Xian**, Shenzhen (CN)

(72) Inventor: **Guimei Xian**, Shenzhen (CN)

(**) Term: **15 Years**

(21) Appl. No.: **29/698,057**

(22) Filed: **Jul. 13, 2019**

(51) **LOC (12) Cl.** **14-01**

(52) **U.S. Cl.**
USPC **D14/223**

(58) **Field of Classification Search**
USPC D14/223, 205; D24/174; 128/864, 865,
128/866; 381/380, 381; 455/90.3, 575.1,
455/569.1

CPC H04R 1/10; H04R 25/00; H04R 1/1066;
H04R 1/1016; H04R 5/033; H04R
5/0335; H04R 1/1091; H04R 1/1058;
A61F 11/06; H02J 7/025

See application file for complete search history.

(56) **References Cited**

U.S. PATENT DOCUMENTS

333,724 A * 1/1886 Blodgett 181/130
3,047,089 A * 7/1962 Zwislocki A61F 11/08
181/135
3,440,365 A * 4/1969 Hazell H04M 1/05
379/430
D266,271 S * 9/1982 Johanson D24/174
4,702,238 A * 10/1987 Scott A61F 11/08
128/867
D304,944 S * 12/1989 Behringer D14/188
5,654,530 A * 8/1997 Sauer H04R 25/652
181/130
6,122,388 A * 9/2000 Feldman H04R 25/604
381/322
6,493,453 B1 * 12/2002 Glendon H04R 23/008
381/322

D470,129 S * 2/2003 Hlas D14/205
6,688,421 B2 * 2/2004 Dyer A61F 11/08
181/130
D488,461 S * 4/2004 Okada D14/223
D508,479 S * 8/2005 Okada D14/206
D550,657 S * 9/2007 Gan D14/223
D579,006 S * 10/2008 Kim D14/223
D628,565 S * 12/2010 Wu D14/223
D631,470 S * 1/2011 Yoneyama D14/223
D652,822 S * 1/2012 Lee D14/223
D666,580 S * 9/2012 Lee D14/223
D668,244 S * 10/2012 Matsumura D14/223
8,406,448 B2 * 3/2013 Lin H04R 1/1091
381/380
D687,021 S * 7/2013 Yuen D14/223
8,776,801 B2 * 7/2014 McIntosh H04R 25/656
128/864
D742,861 S * 11/2015 Miyake D14/223
D764,445 S * 8/2016 Czaniecki D14/223
D777,710 S * 1/2017 Palmborg D14/223

(Continued)

FOREIGN PATENT DOCUMENTS

EM 006792735-0001 * 8/2019
EM 008053755-0002 * 7/2020

Primary Examiner — Paula Allen Greene

(57) **CLAIM**

The ornamental design for a wireless earbud, as shown and described.

DESCRIPTION

FIG. 1 is a front perspective view of the wireless earbud showing my new design;
FIG. 2 is a front elevational view thereof;
FIG. 3 is a rear elevational view thereof;
FIG. 4 is a left side elevational view thereof;
FIG. 5 is a right side elevational view thereof;
FIG. 6 is a top plan view thereof; and,
FIG. 7 is a bottom plan view thereof.

1 Claim, 7 Drawing Sheets

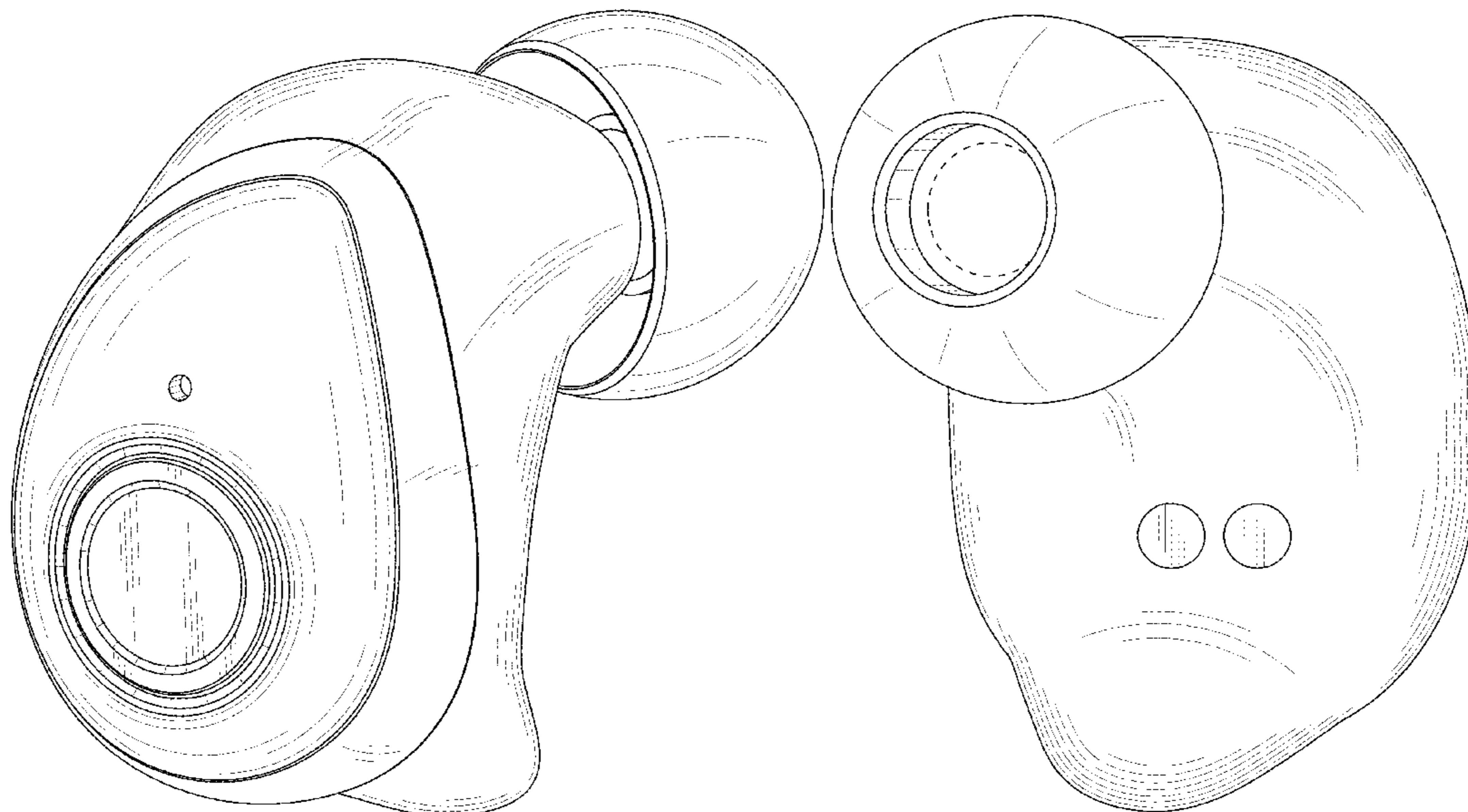

(56)

References Cited

U.S. PATENT DOCUMENTS

D781,269 S * 3/2017 Choe D14/223
D788,079 S * 5/2017 Son D14/223
D789,909 S * 6/2017 Hung D14/223
D798,843 S * 10/2017 Valenzuela D14/223
D800,097 S * 10/2017 Chen D14/223
D806,879 S * 1/2018 Horbinski D24/174
D808,934 S * 1/2018 Tang D14/223
D810,054 S * 2/2018 Yuan D14/223
D826,211 S * 8/2018 Kim D14/206
D841,626 S * 2/2019 Tang D14/223
D842,844 S * 3/2019 Li D14/223
D845,932 S * 4/2019 Lu D14/223
D852,171 S * 6/2019 Cai D14/223
D852,782 S * 7/2019 Bergman D14/223
D858,489 S * 9/2019 Hu D14/223
D863,263 S * 10/2019 Yu D14/223
D864,167 S * 10/2019 Wu D14/223
D866,530 S * 11/2019 Birger D14/223
D868,750 S * 12/2019 Zheng D14/223
D868,752 S * 12/2019 Zhu D14/223
D871,376 S * 12/2019 Zhou D14/223
D872,064 S * 1/2020 Cai D14/223
D873,248 S * 1/2020 Weicheng D14/223
D873,805 S * 1/2020 Yang D14/223
D876,398 S * 2/2020 Cai D14/223
D877,721 S * 3/2020 Jung D14/223
D883,958 S * 5/2020 Liu D14/223
D890,727 S * 7/2020 Park D14/223
D892,086 S * 8/2020 Bonahoom D14/223
D892,769 S * 8/2020 Cai D14/223
D893,461 S * 8/2020 Gu D14/223
D894,158 S * 8/2020 Gu D14/223
2017/0026738 A1 * 1/2017 Tang H04R 1/1091

* cited by examiner

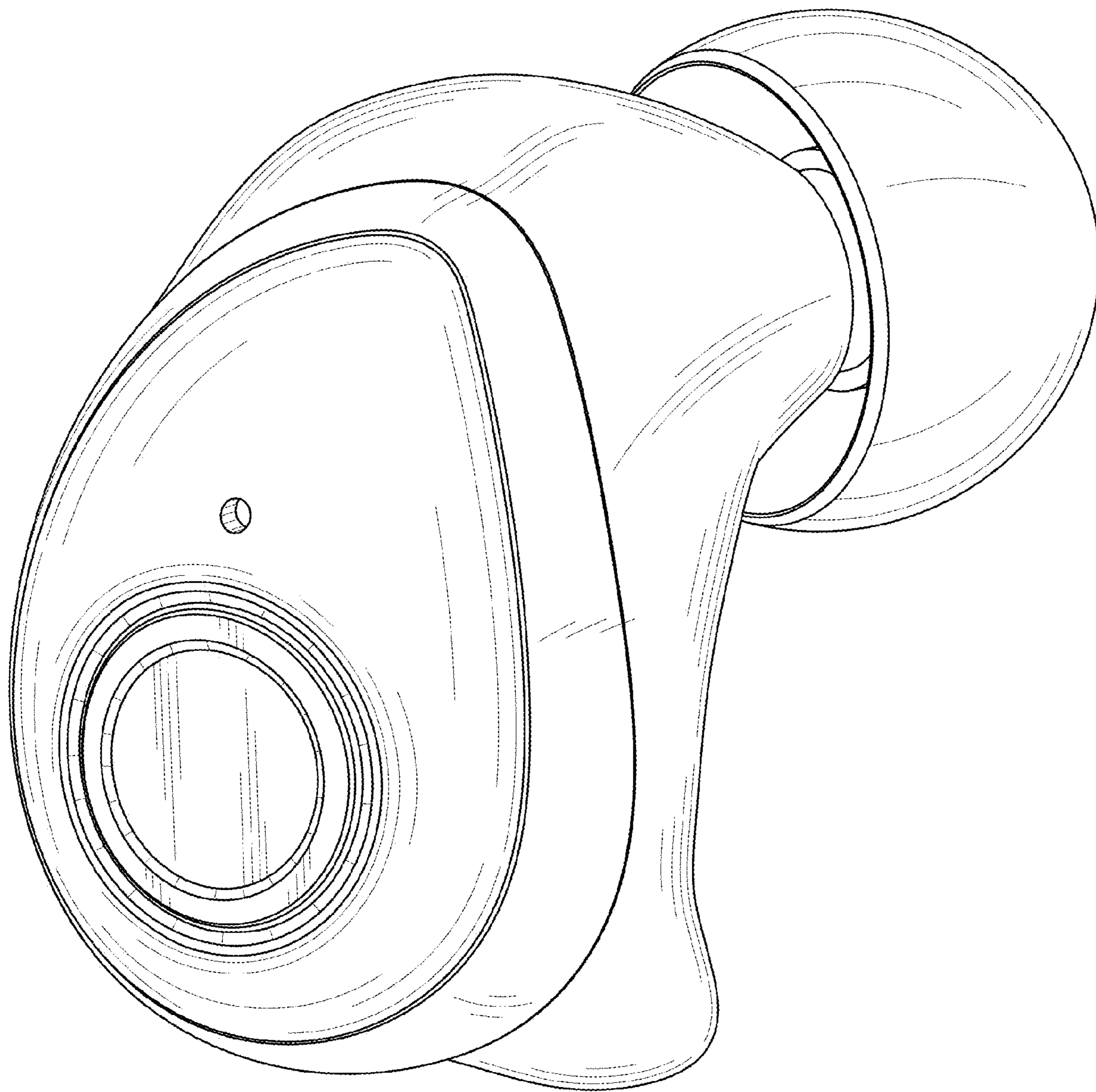

FIG. 1

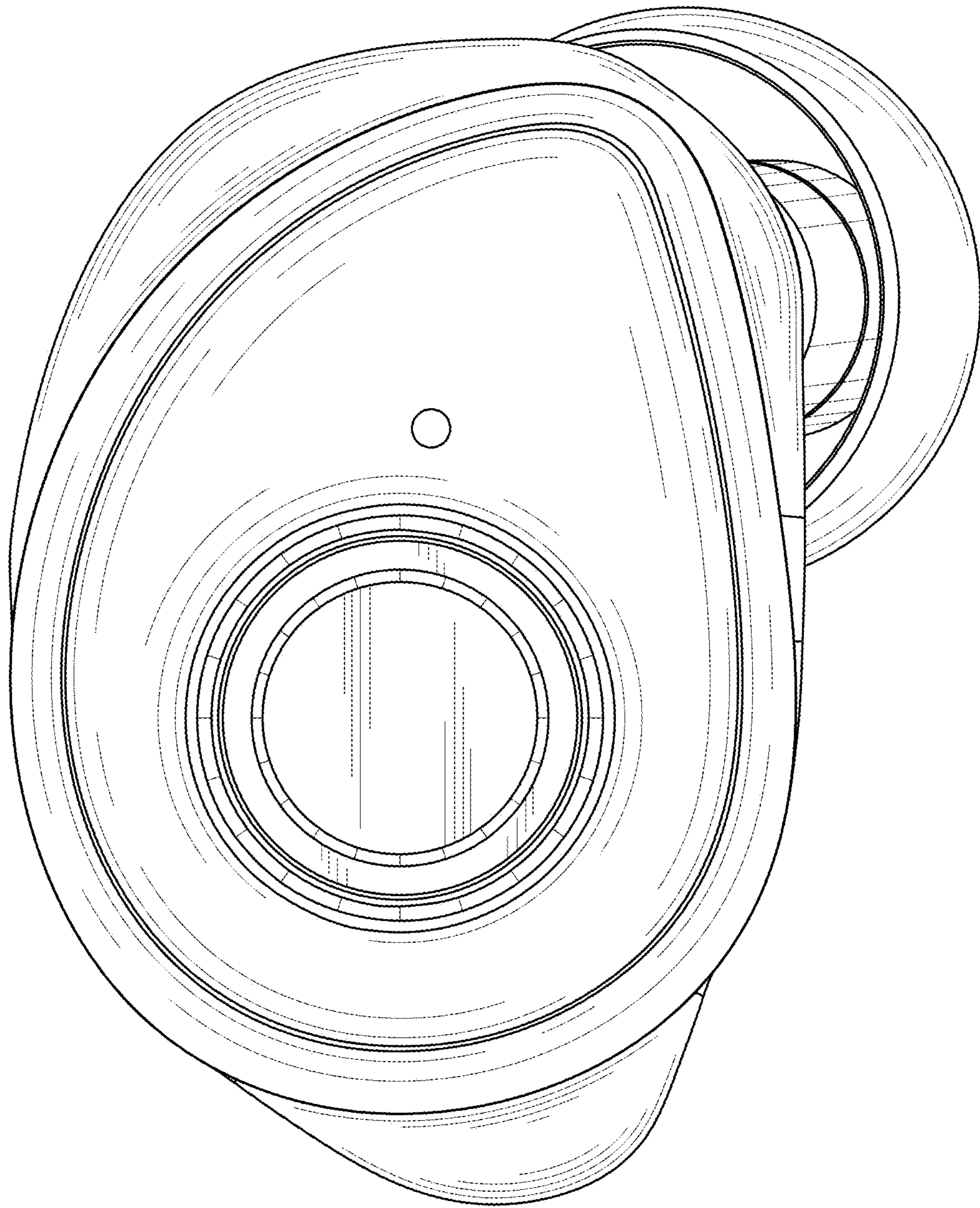

FIG. 2

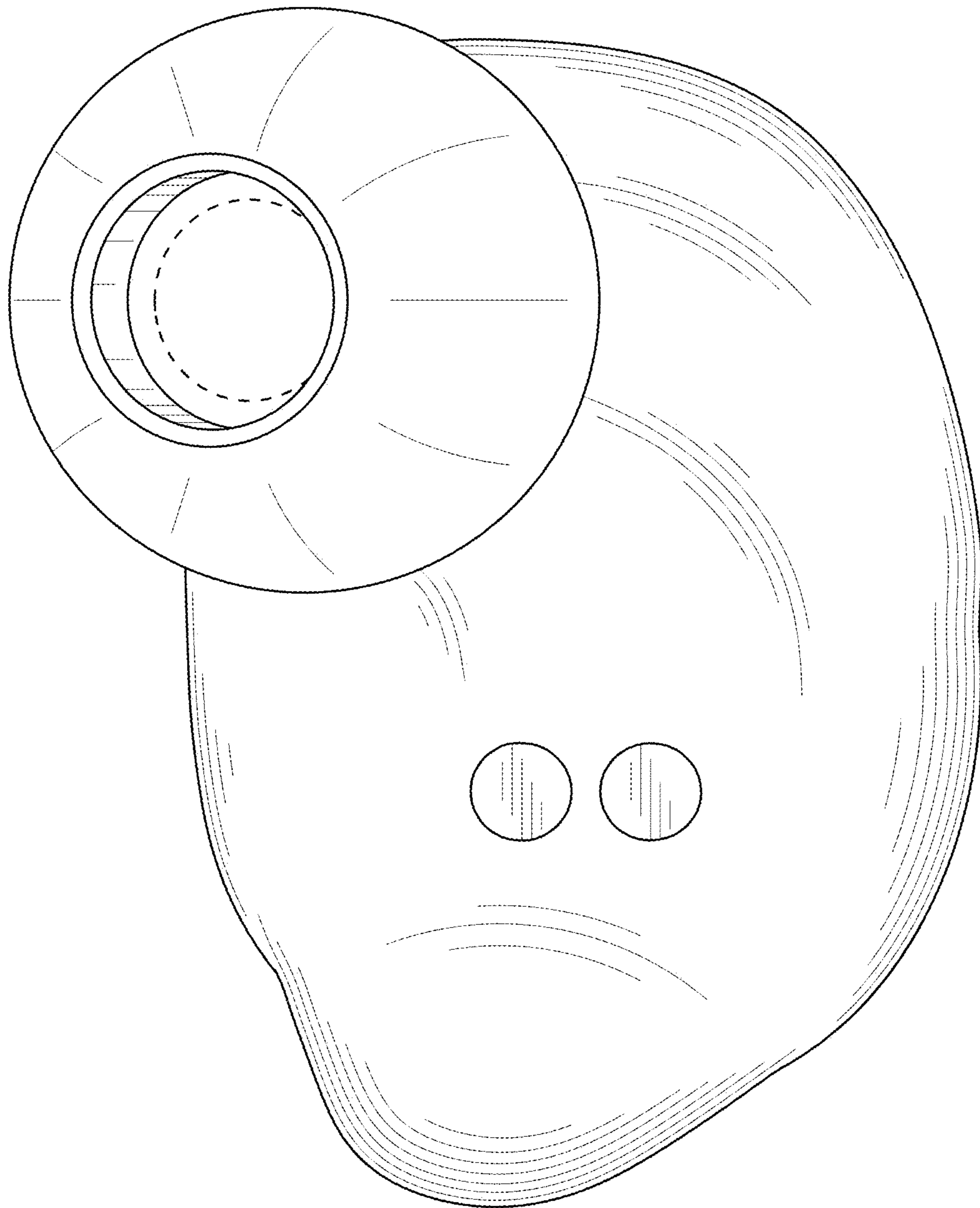

FIG. 3

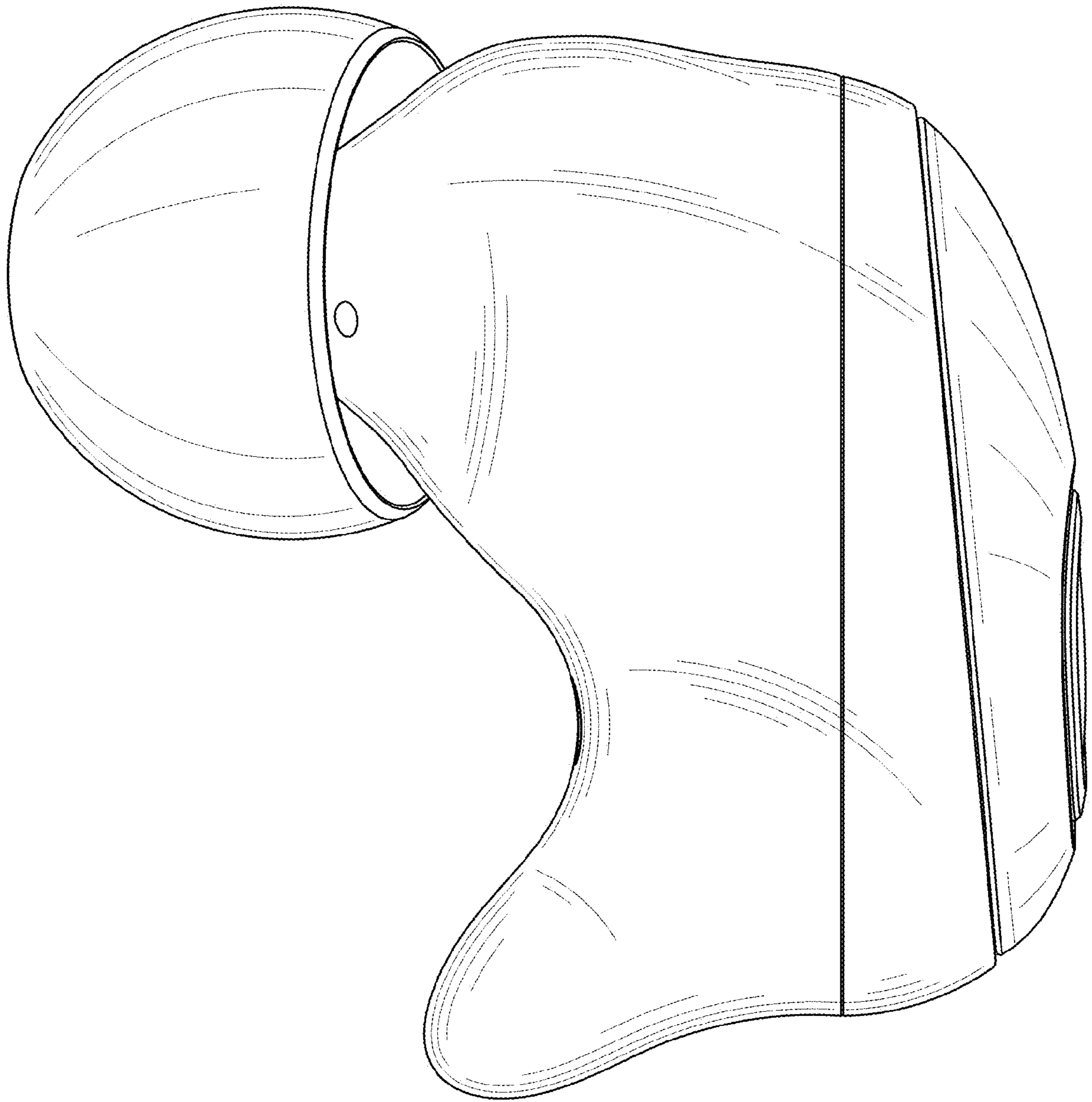

FIG. 4

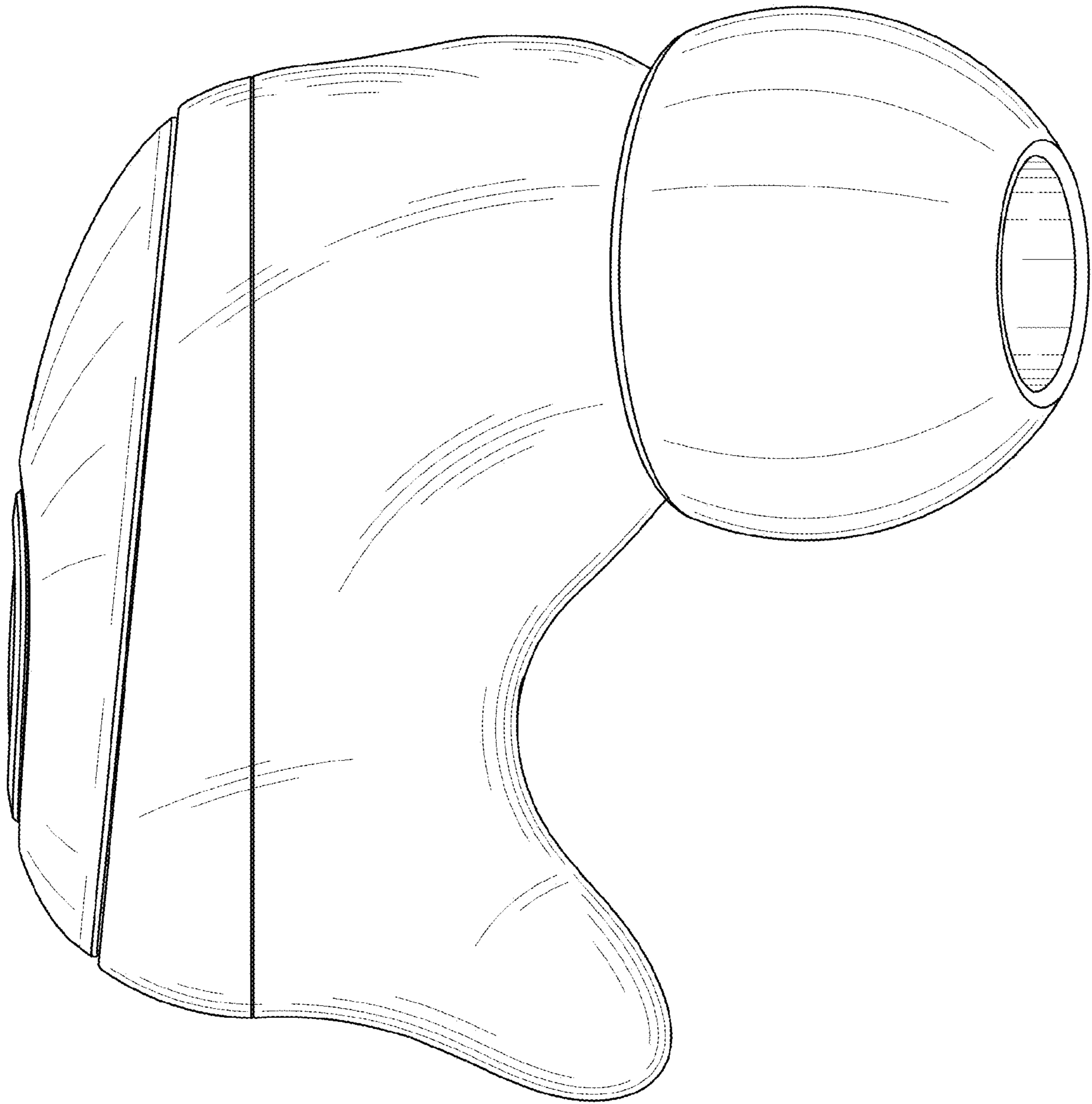

FIG. 5

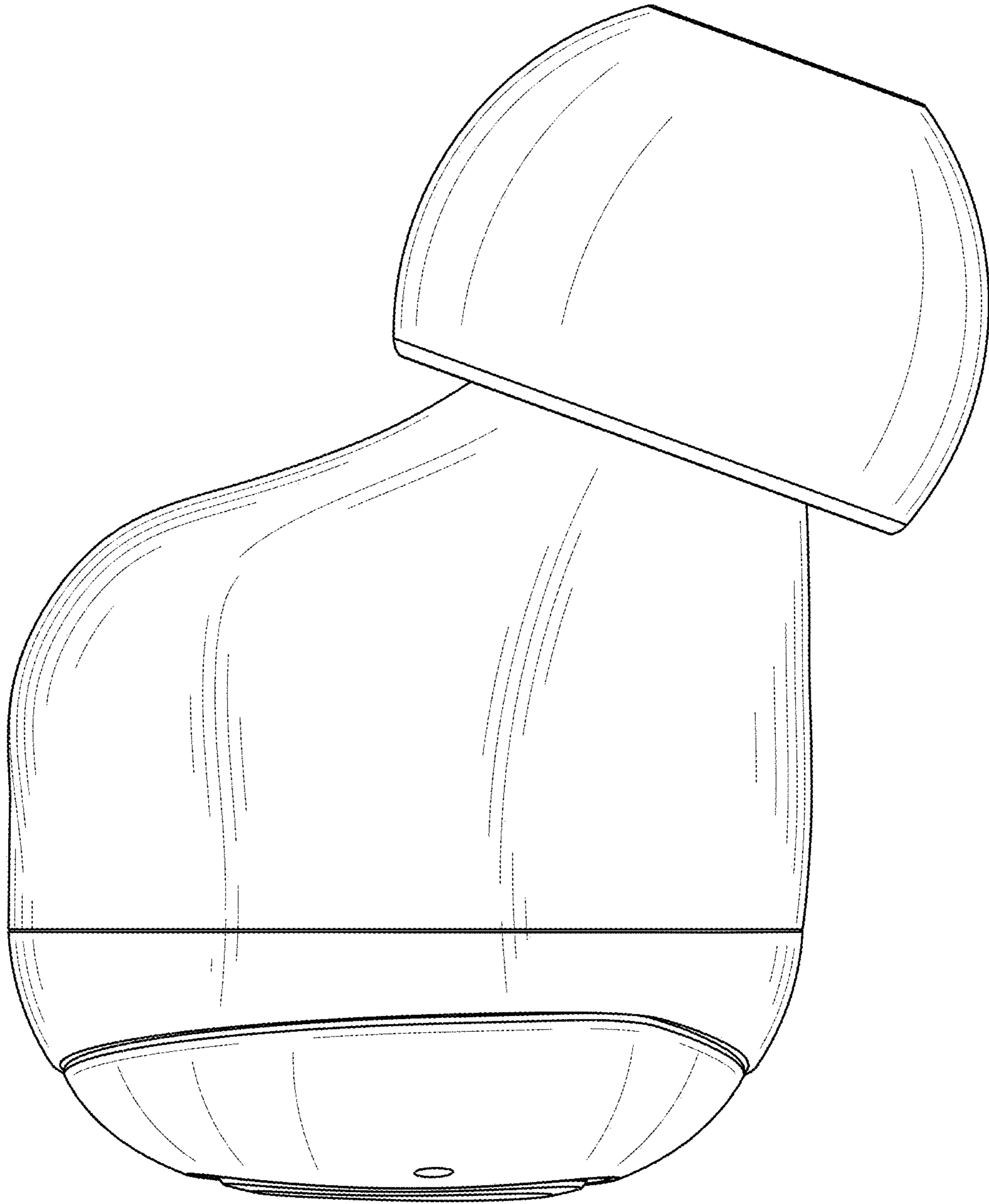

FIG. 6

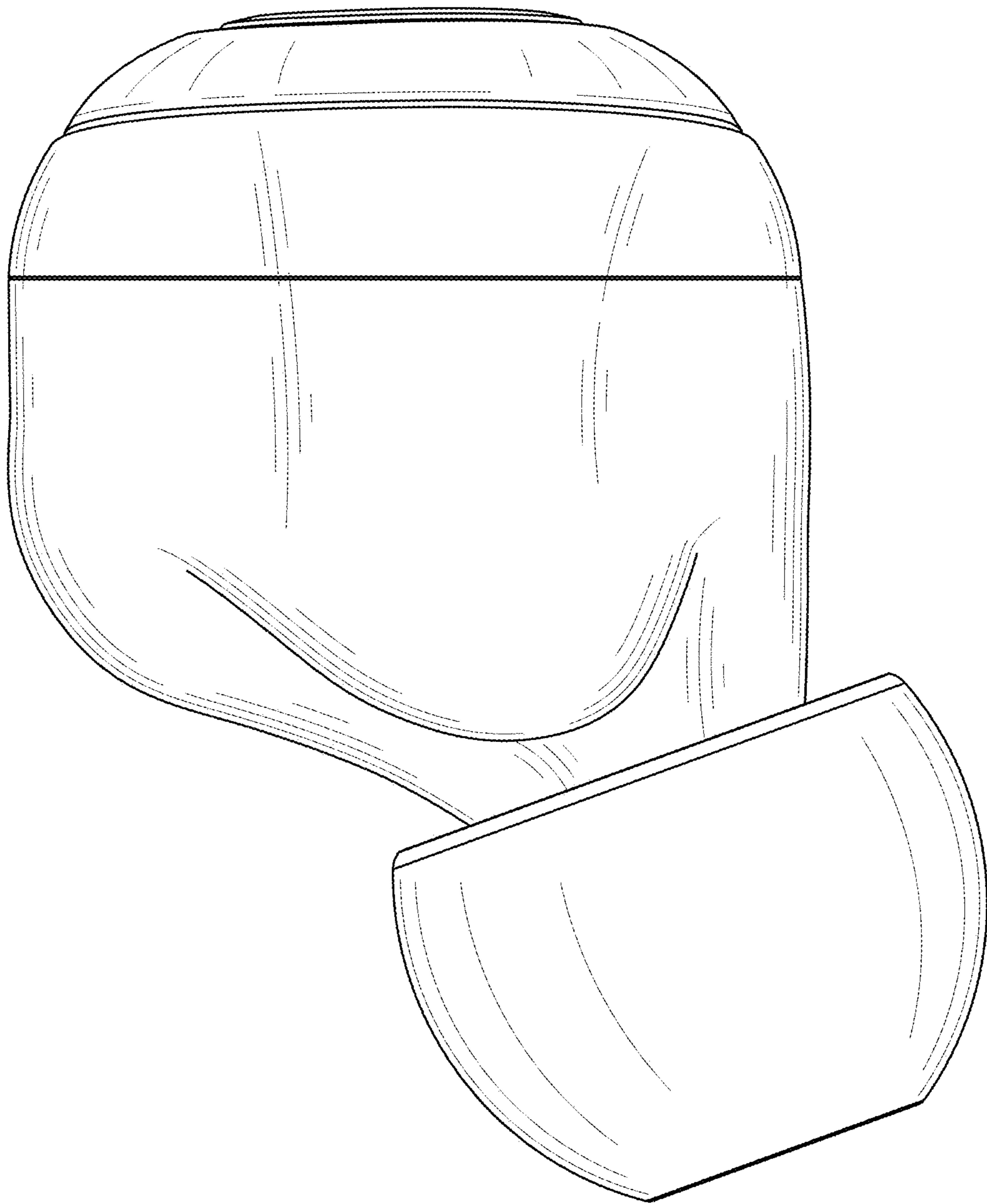

FIG. 7