



US00D902167S

(12) **United States Design Patent** (10) **Patent No.:** **US D902,167 S**
Lee et al. (45) **Date of Patent:** **** Nov. 17, 2020**

(54) **FOLDABLE MOBILE PHONE**

1/0295; H04M 1/02; H04M 1/0279;
H04M 1/0283

(71) Applicant: **HUIZHOU TCL MOBILE COMMUNICATION CO., LTD,**
Huizhou (CN)

See application file for complete search history.

(56) **References Cited**

U.S. PATENT DOCUMENTS

(72) Inventors: **Shiuan Hung Lee**, Huizhou (CN); **Yan Zhu**, Huizhou (CN); **Yongde Xu**, Huizhou (CN); **Fuqiang Ye**, Huizhou (CN); **Huajie Wu**, Huizhou (CN); **Luxi Zhou**, Huizhou (CN); **Jianwei Wang**, Huizhou (CN); **Tianyuan Shi**, Huizhou (CN)

D782,439 S *	3/2017	Choo	D14/138 AA
D804,443 S *	12/2017	Kang	D14/138 AB
D814,435 S *	4/2018	Kwon	D14/138 AB
D825,518 S *	8/2018	Kikuchi	D14/138 AB
D828,321 S *	9/2018	Yeom	D14/138 AB
D859,341 S *	9/2019	Kang	D14/138 AB
D859,347 S *	9/2019	Kwon	D14/138 AB
D859,349 S *	9/2019	Yeom	D14/138 AB

(Continued)

Primary Examiner — Bridget L Eland

(73) Assignee: **HUIZHOU TCL MOBILE COMMUNICATION CO., LTD.,**
Huizhou (CN)

(57) **CLAIM**

The ornamental design for a foldable mobile phone, as shown and described.

(**) Term: **15 Years**

DESCRIPTION

(21) Appl. No.: **29/680,362**

(22) Filed: **Feb. 15, 2019**

(30) **Foreign Application Priority Data**

Jan. 28, 2019 (CN) 2019 3 0048835

(51) **LOC (12) Cl.** **14-03**

(52) **U.S. Cl.**
USPC **D14/138 AB**

(58) **Field of Classification Search**
USPC D14/138 AB, 248, 341, 371, 374, 138 R,
D14/138 AA, 138 G, 138 AC, 138 AD,
D14/138 C, 247
CPC H04M 1/0202; H04M 1/0235; H04M
1/0237; H04M 1/0239; H04M 1/0266;
H04M 1/0268; H04M 1/027; H04M

FIG. 1 is a perspective view of a foldable mobile phone shown in an unfolded state;
FIG. 2 is another perspective view thereof;
FIG. 3 is a front elevational view thereof;
FIG. 4 is a rear elevational view thereof;
FIG. 5 is a left side elevational view thereof;
FIG. 6 is a right side elevational view thereof;
FIG. 7 is a top plan view thereof;
FIG. 8 is a bottom plan view thereof;
FIG. 9 is a perspective view of the foldable mobile phone shown in FIG. 1 in a first folded state;
FIG. 10 is another perspective view thereof;
FIG. 11 is a front elevational view thereof;
FIG. 12 is a rear elevational view thereof;
FIG. 13 is a left side elevational view thereof;
FIG. 14 is a right side elevational view thereof;
FIG. 15 is a top plan view thereof;
FIG. 16 is a bottom plan view thereof;
FIG. 17 is a perspective view of the foldable mobile phone shown in FIG. 1, in a second folded state; and,

(Continued)

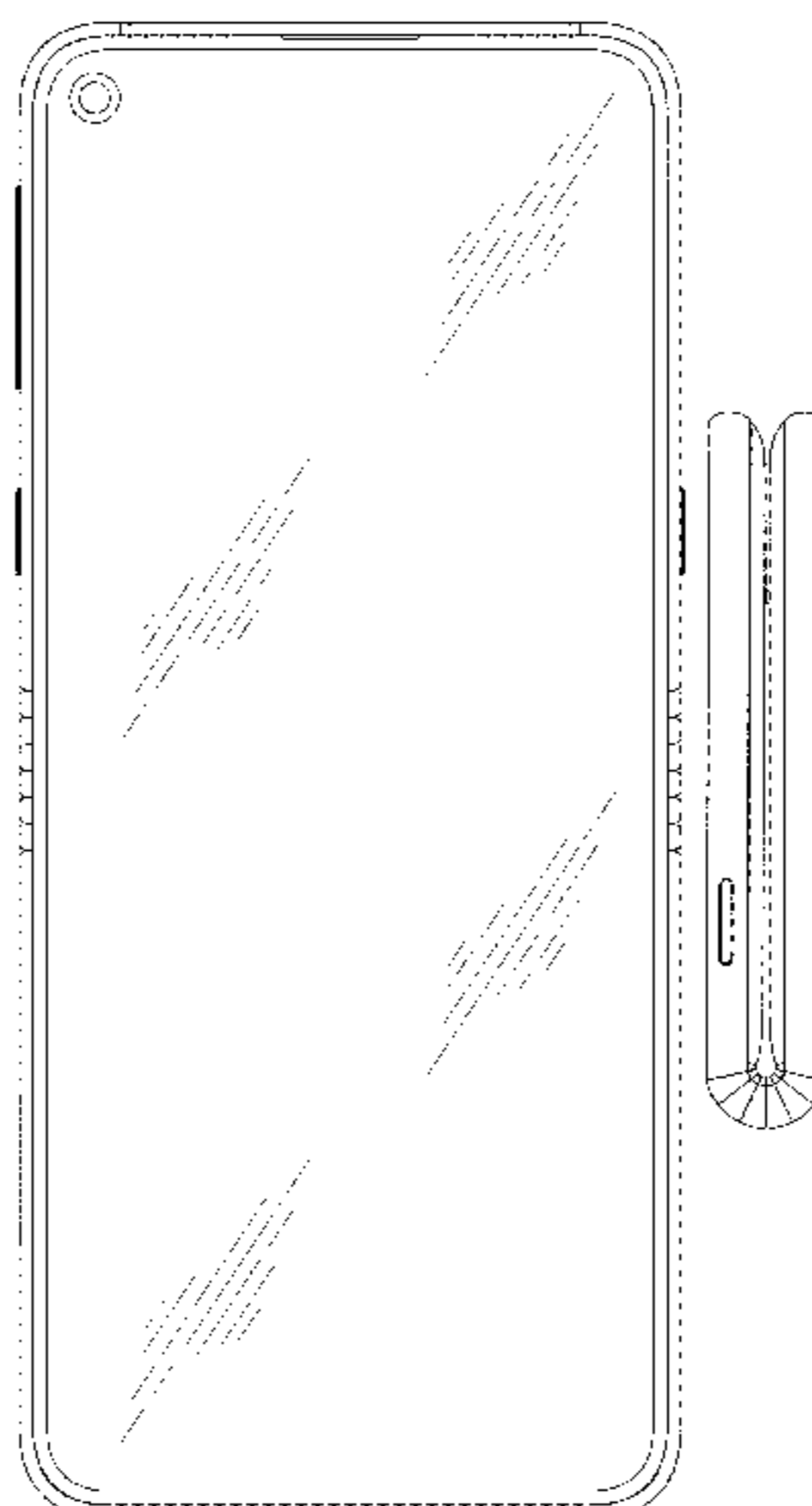

FIG. 18 is another perspective view thereof.
The shade lines in the figures show contour.

1 Claim, 16 Drawing Sheets

(56)

References Cited

U.S. PATENT DOCUMENTS

D869,423 S *	12/2019	Cho	D14/138 G
D884,664 S *	5/2020	Kwon	D14/138 AB
D885,381 S *	5/2020	Hwang	D14/345
2006/0105824 A1 *	5/2006	Kim	H04M 1/0214
				455/575.8
2014/0111954 A1 *	4/2014	Lee	G06F 1/1641
				361/749
2014/0226275 A1 *	8/2014	Ko	G06F 1/1681
				361/679.27

2015/0043174 A1 *	2/2015	Han	G06F 1/1626
				361/749
2015/0370287 A1 *	12/2015	Ko	G06F 1/1681
				361/749
2016/0048170 A1 *	2/2016	Kim	G06F 3/0416
				345/173
2016/0116944 A1 *	4/2016	Lee	G06F 1/1616
				361/679.26
2016/0132075 A1 *	5/2016	Tazbaz	H04M 1/0216
				361/679.27
2016/0195901 A1 *	7/2016	Kauhaniemi	G06F 1/1681
				361/679.27
2016/0324023 A1 *	11/2016	Kim	G06F 1/1624
2016/0357221 A1 *	12/2016	Huh	H04M 1/72569
2017/0069299 A1 *	3/2017	Kwak	G06F 3/147
2017/0094168 A1 *	3/2017	Kang	G06F 1/1652
2017/0357289 A1 *	12/2017	Ahn	G06F 1/1652
2018/0011515 A1 *	1/2018	Yoo	G06F 1/1681
2018/0035208 A1 *	2/2018	Choi	G06F 3/165
2018/0049329 A1 *	2/2018	Seo	H05K 5/0017
2020/0097044 A1 *	3/2020	Kim	G06F 1/1607

* cited by examiner

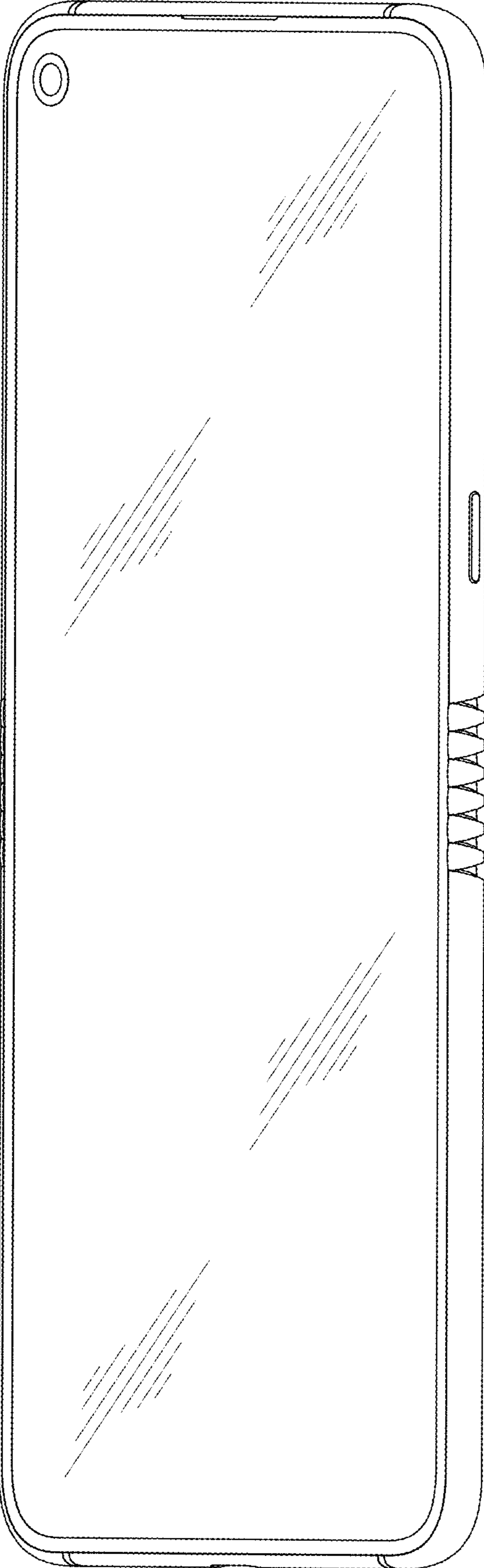

FIG. 1

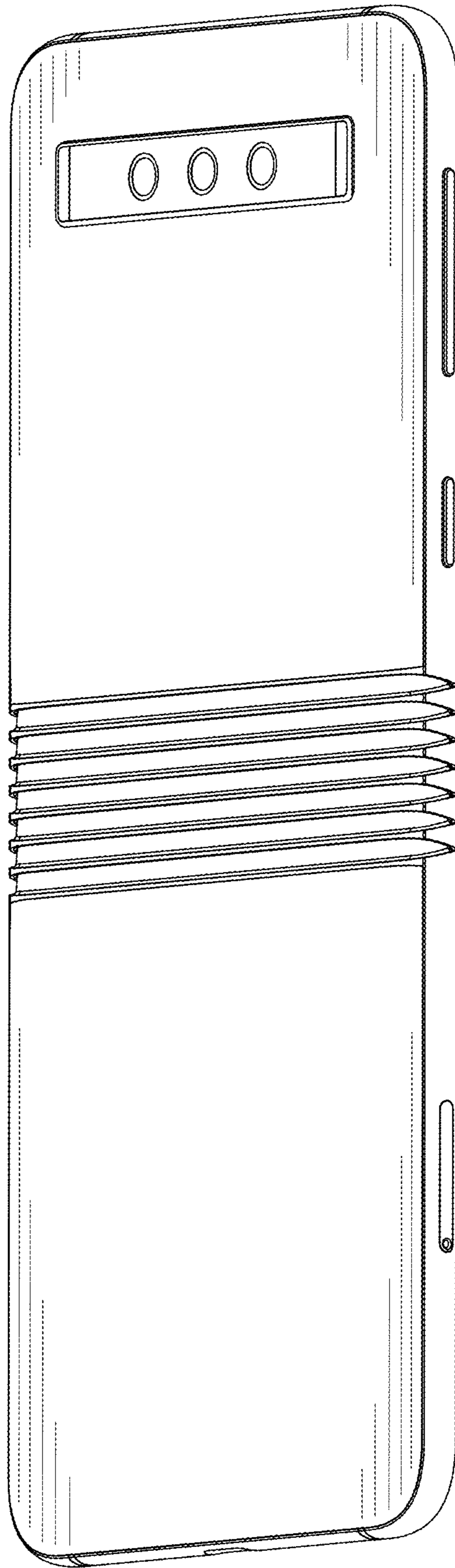

FIG. 2

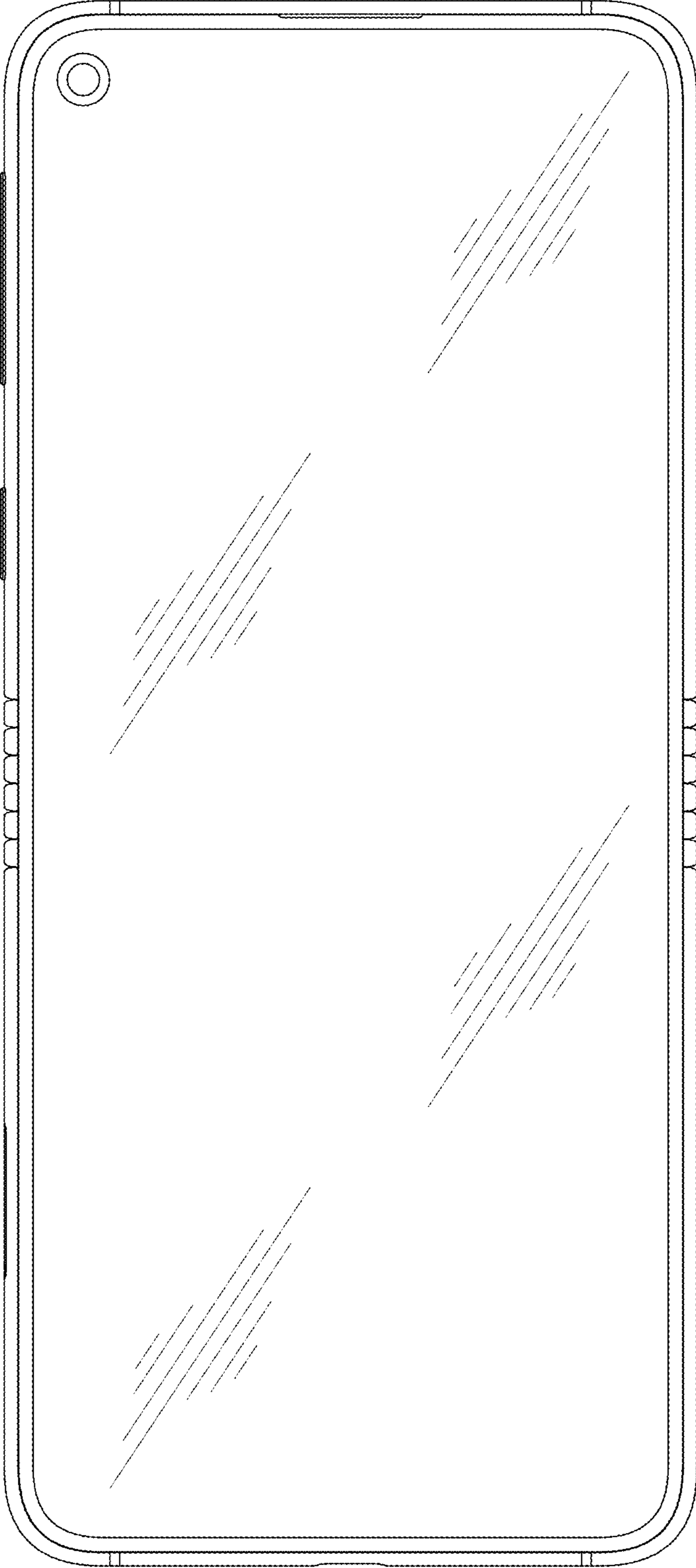

FIG. 3

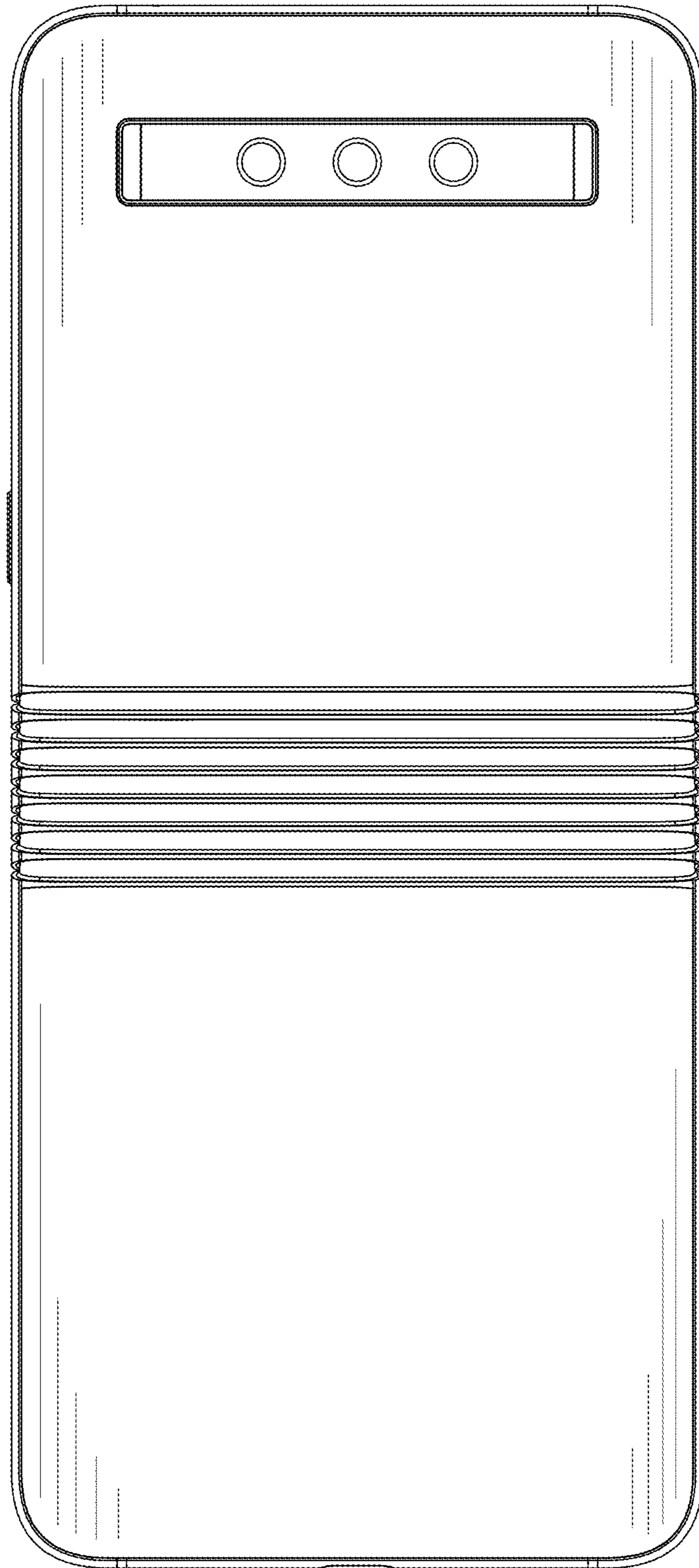

FIG. 4



FIG. 5

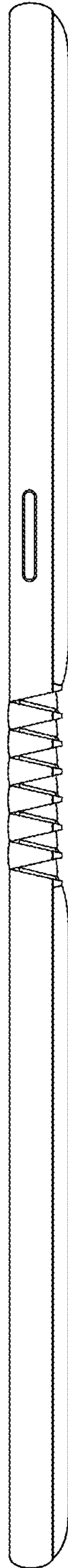

FIG. 6

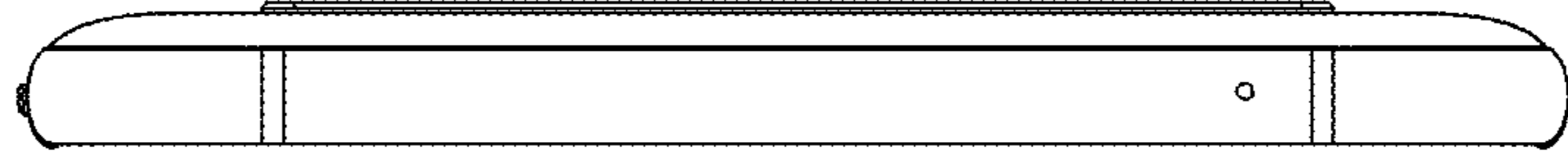

FIG. 7



FIG. 8

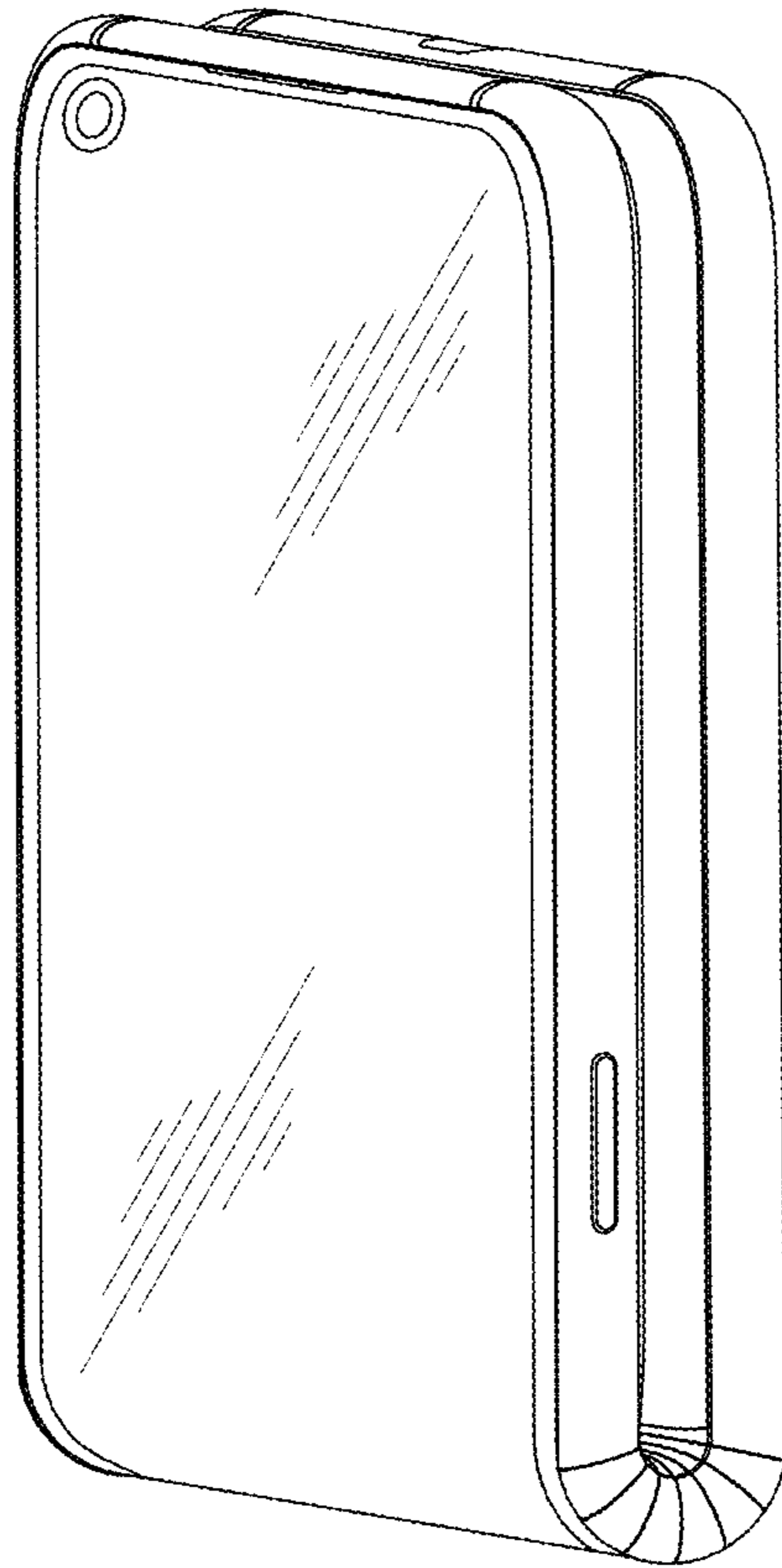

FIG. 9

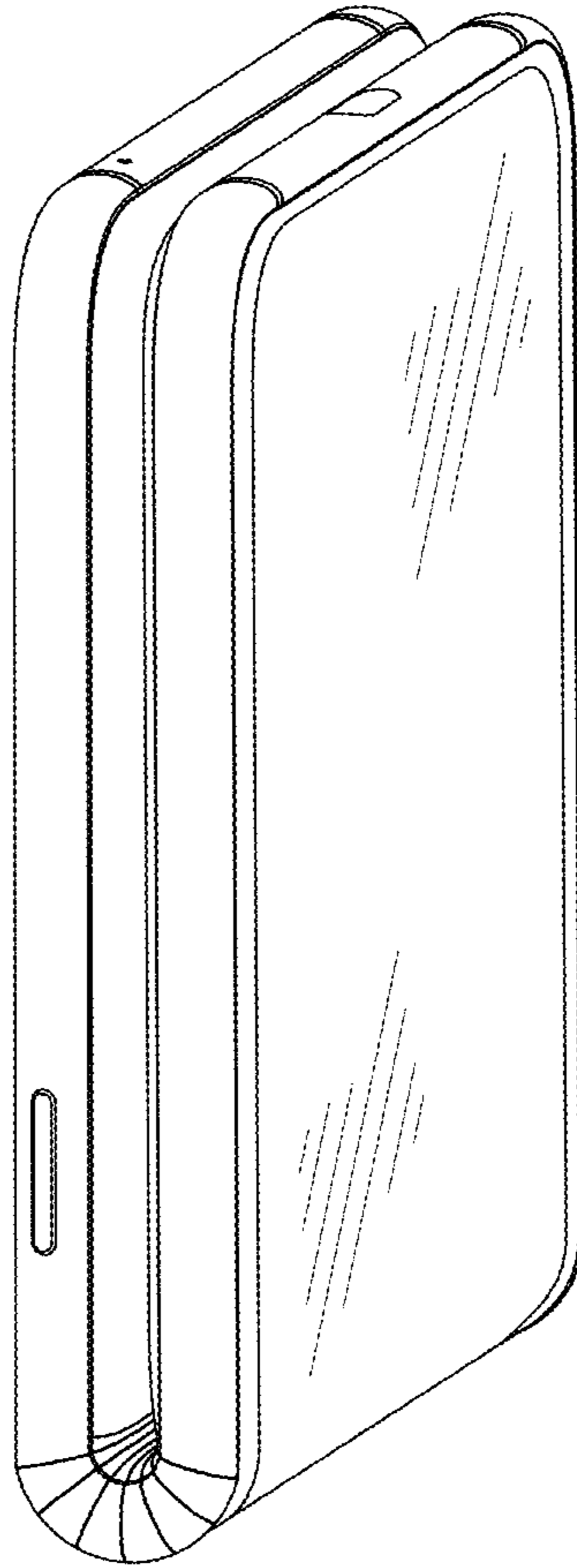

FIG. 10

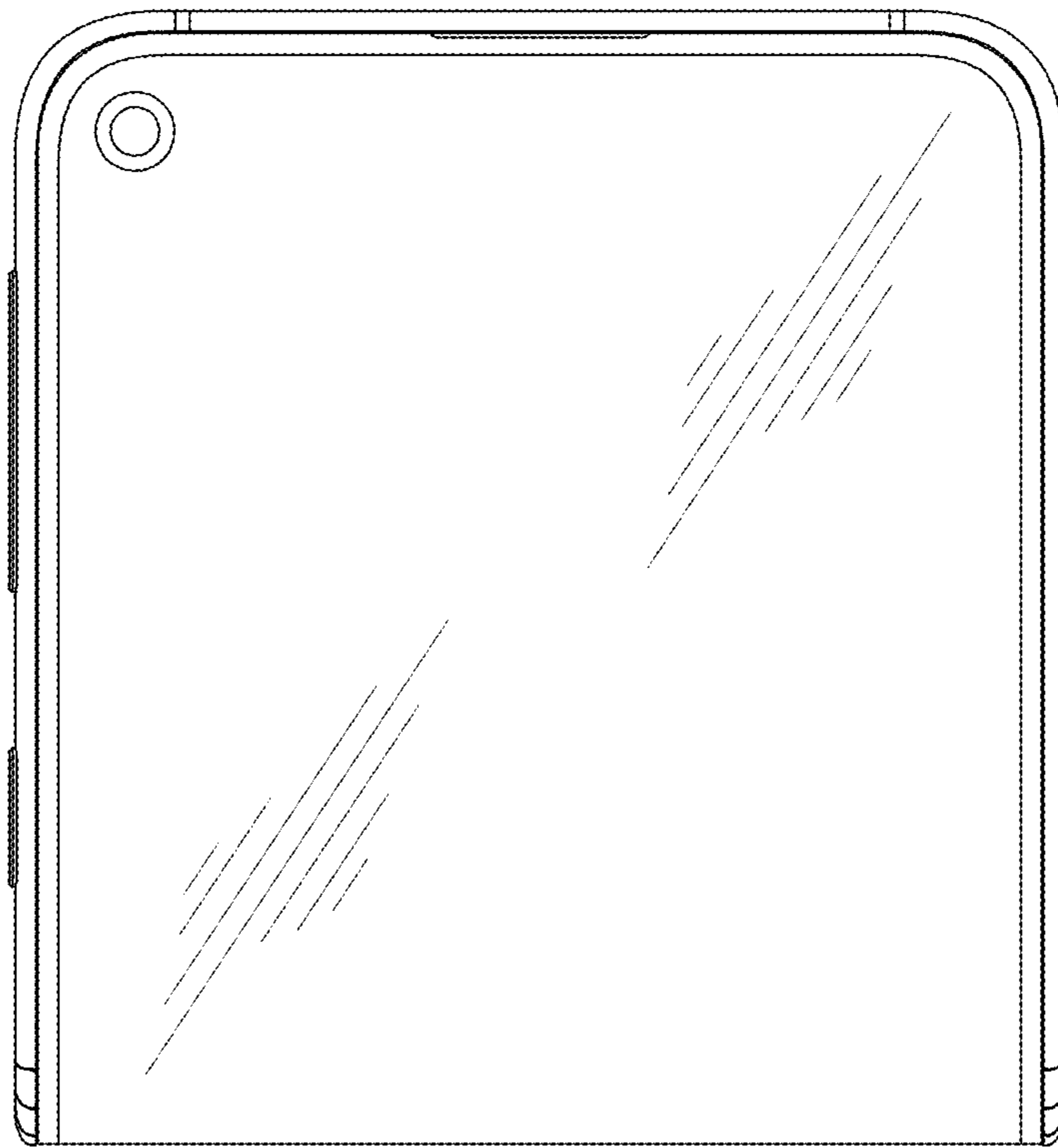

FIG. 11

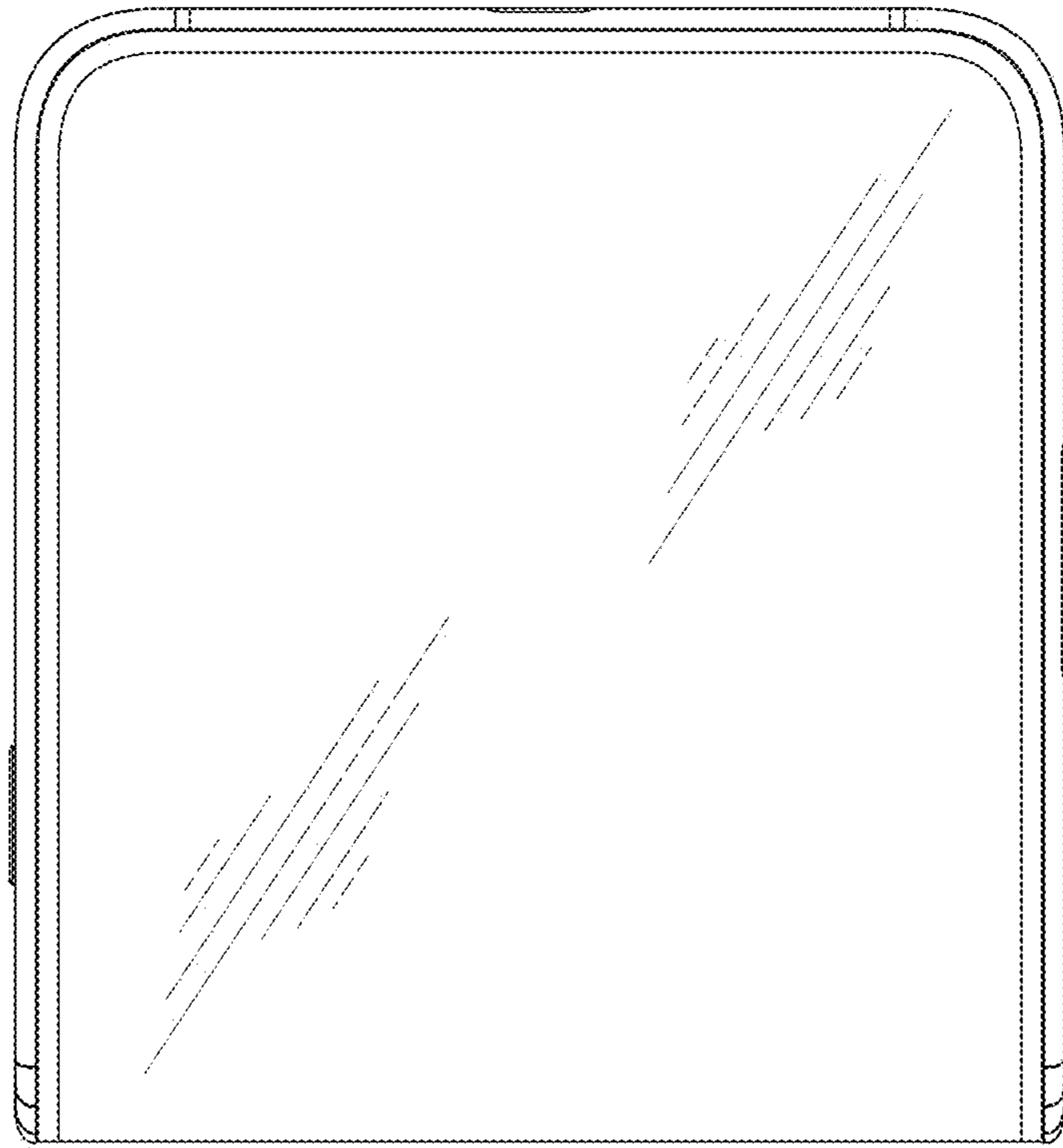

FIG. 12

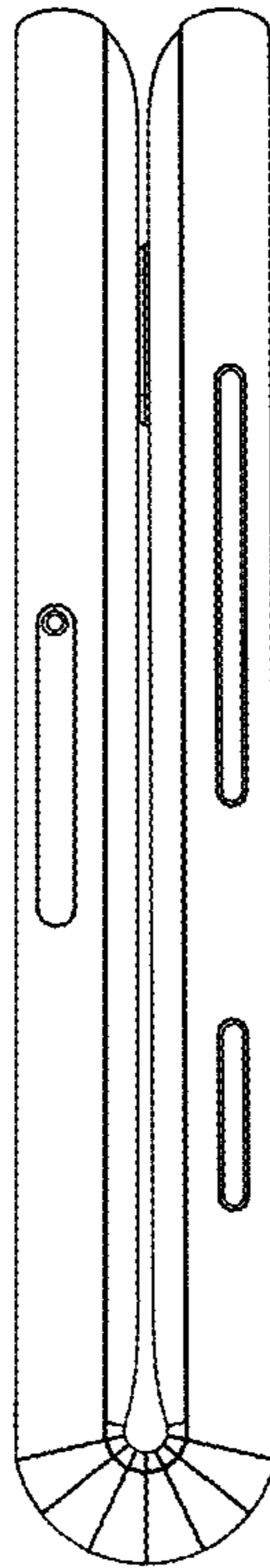

FIG. 13

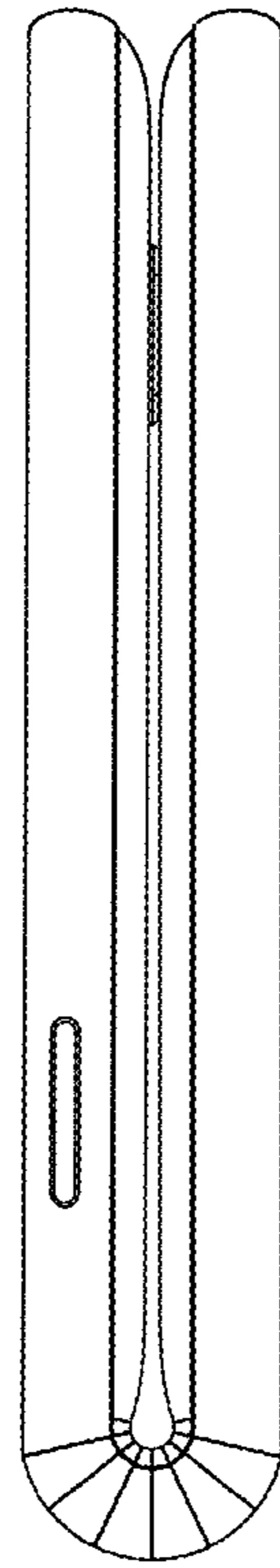

FIG. 14

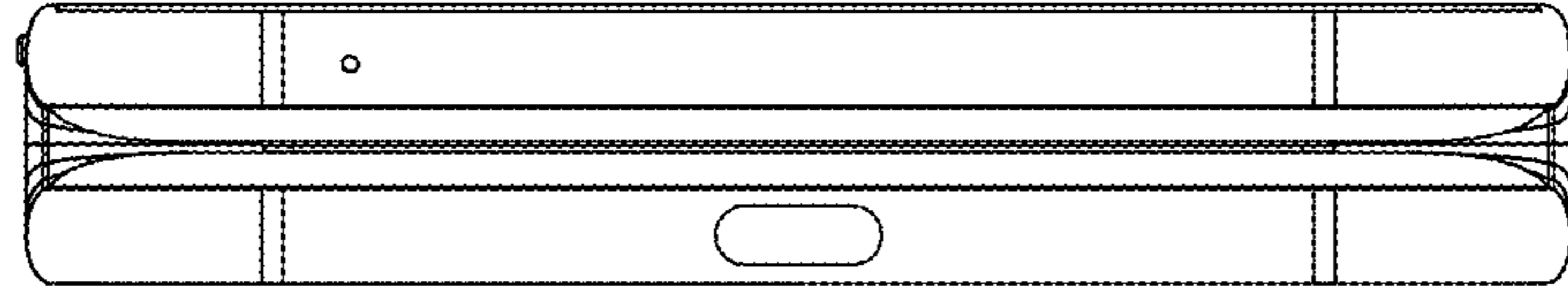

FIG. 15



FIG. 16

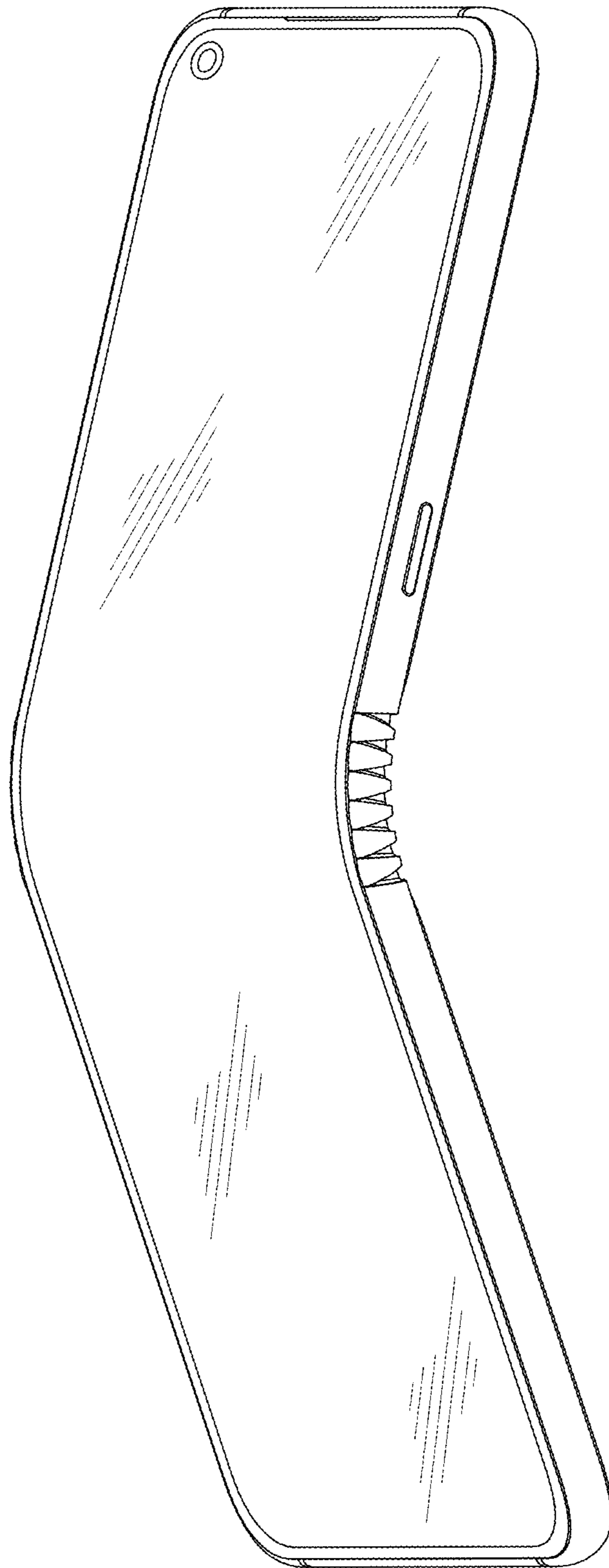

FIG. 17

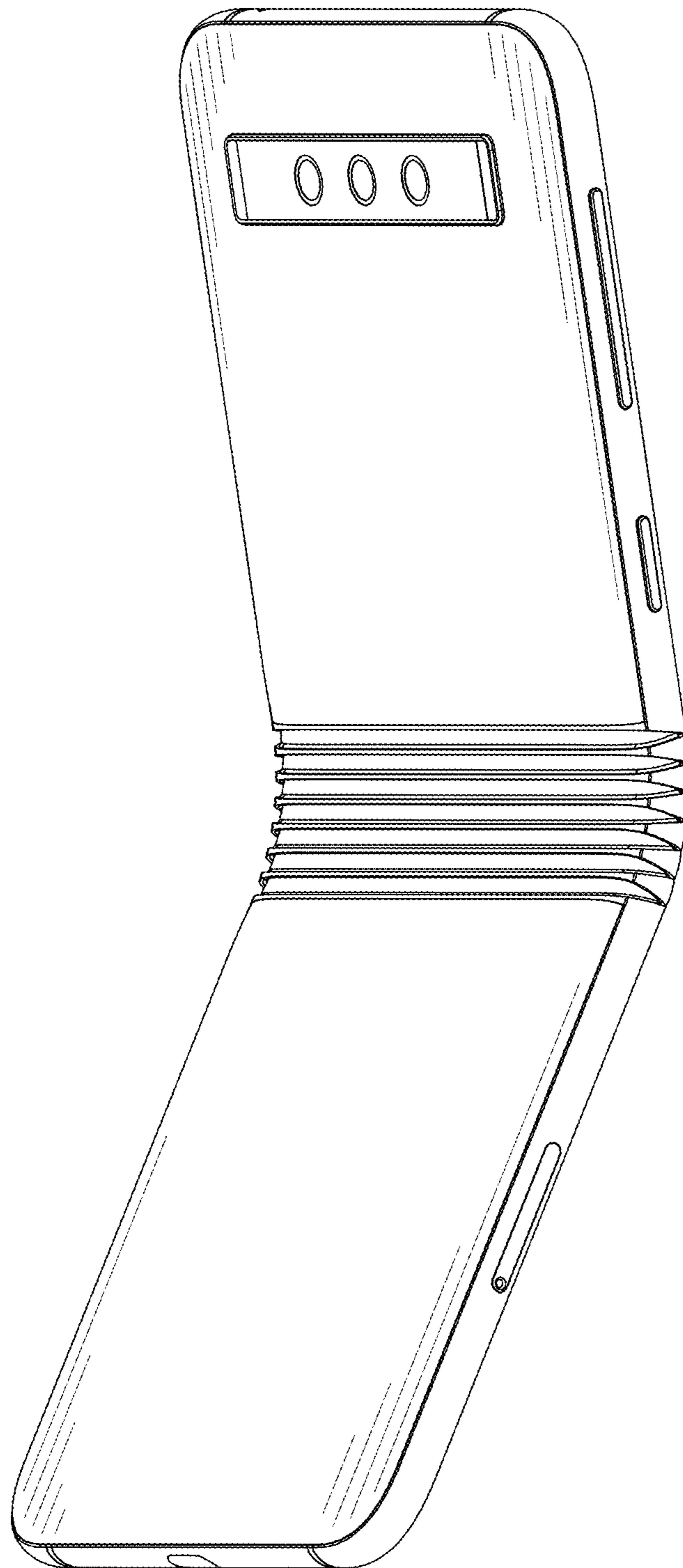

FIG. 18