



US00D902066S

(12) **United States Design Patent**
D'amore et al.

(10) **Patent No.:** **US D902,066 S**

(45) **Date of Patent:** **** Nov. 17, 2020**

(54) **BRACELET**

(71) Applicants: **John J. D'amore**, Mahwah, NJ (US);
Wendi Nelson Denny, Chapel Hill, NC (US)

(72) Inventors: **John J. D'amore**, Mahwah, NJ (US);
Wendi Nelson Denny, Chapel Hill, NC (US)

(**) Term: **15 Years**

(21) Appl. No.: **29/602,149**

(22) Filed: **Apr. 28, 2017**

(51) **LOC (12) Cl.** **11-01**

(52) **U.S. Cl.**
USPC **D11/4**

(58) **Field of Classification Search**
USPC D11/1-7, 16, 40-45, 47-50, 52-54,
D11/56-58, 61, 63, 75-86; D3/207-211;
D28/41
CPC A44C 1/00; A44C 5/00; A44C 5/0007;
A44C 5/02; A44C 7/00; A44C 7/002;
A44C 7/003; A44C 7/004; A44C 7/005;
A44C 7/006; A44C 7/007; A44C 7/008;
A44C

(Continued)

(56) **References Cited**

U.S. PATENT DOCUMENTS

1,020,148 A * 3/1912 Lettre A44C 5/0092
63/6
D386,999 S * 12/1997 Kothari D11/4
D394,411 S * 5/1998 Gozlan D11/4

(Continued)

Primary Examiner — Wendy L Arminio

(74) *Attorney, Agent, or Firm* — Richard Malagiere, Esq.

(57) **CLAIM**

We claim the ornamental design for a bracelet, as shown and described.

DESCRIPTION

FIG. 1 is a perspective view of an embodiment of the bracelet.

FIG. 2 is a front view thereof.

FIG. 3 is a rear view thereof.

FIG. 4 is a side view thereof.

FIG. 5 is a side view thereof.

FIG. 6 is a top view thereof.

FIG. 7 is a bottom view thereof.

FIG. 8 is an exploded view thereof.

FIG. 9 is a perspective view of an alternate embodiment of the bracelet

FIG. 10 is a front view thereof.

FIG. 11 is a rear view thereof.

FIG. 12 is a side view thereof.

FIG. 13 is a side view thereof.

FIG. 14 is a top view thereof.

FIG. 15 is a bottom view thereof.

FIG. 16 is an exploded view thereof.

FIG. 17 is a perspective view of an alternate embodiment of the bracelet

FIG. 18 is a front view thereof.

FIG. 19 is a rear view thereof.

FIG. 20 is a side view thereof.

FIG. 21 is a side view thereof.

FIG. 22 is a top view thereof.

FIG. 23 is a bottom view thereof.

FIG. 24 is an exploded view thereof.

FIG. 25 is a perspective view of an alternate embodiment of the bracelet

FIG. 26 is a front view thereof.

FIG. 27 is a rear view thereof.

FIG. 28 is a side view thereof.

FIG. 29 is a side view thereof.

FIG. 30 is a top view thereof.

FIG. 31 is a bottom view thereof; and,

FIG. 32 is an exploded view thereof.

The broken lines in FIGS. 8 and 16 depict portions of the bracelet that form no part of the claimed design.

1 Claim, 16 Drawing Sheets

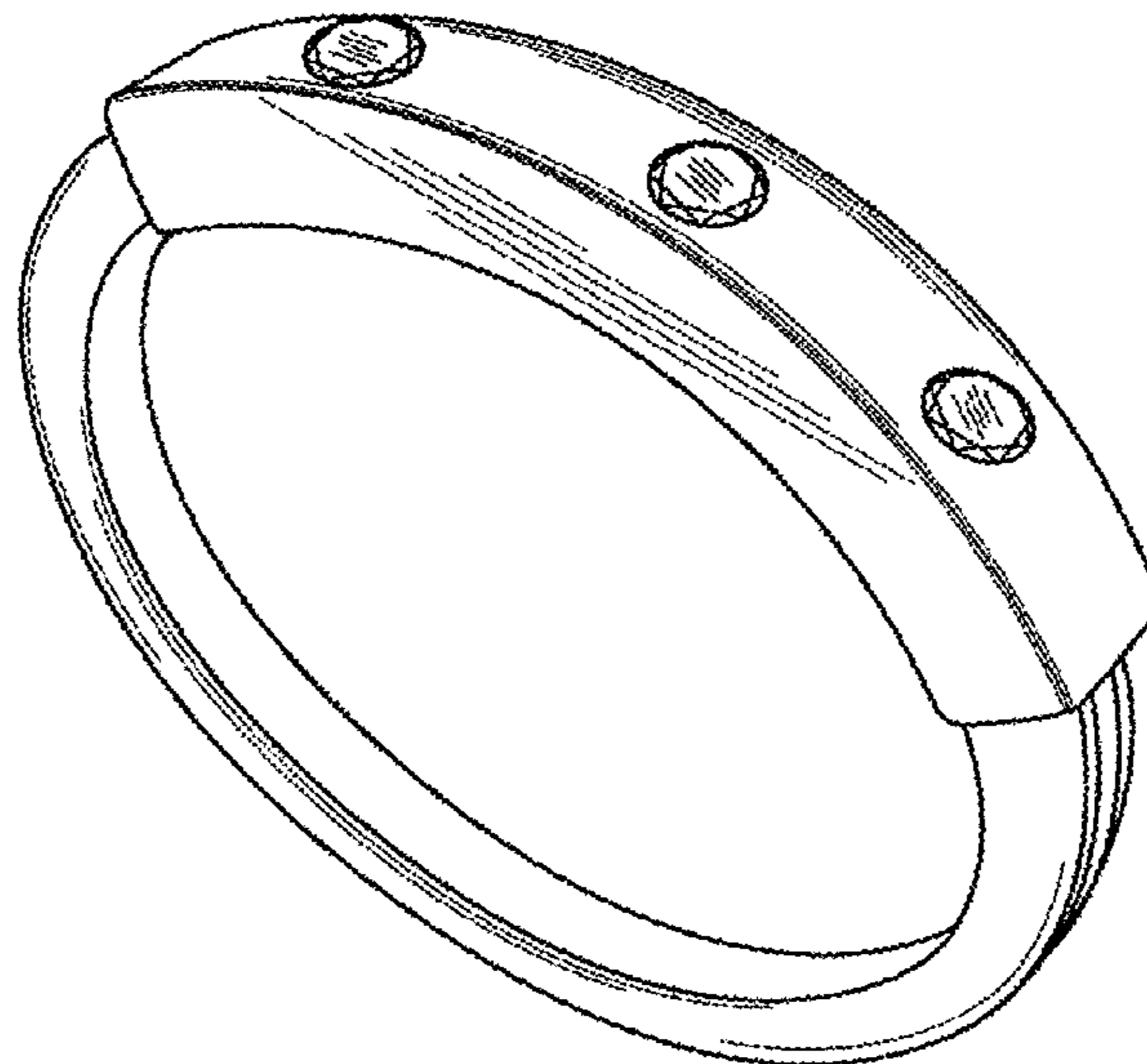

(58) **Field of Classification Search**
 CPC 7/009; A44C 15/00; A44C 25/00; A44C
 25/001; A44C 25/002; A44C 25/007
 See application file for complete search history.

(56) **References Cited**

U.S. PATENT DOCUMENTS

D456,296	S	*	4/2002	Ambar	D11/4
D463,307	S	*	9/2002	Charriol	D11/3
D470,429	S	*	2/2003	Bonnet	D11/3
D515,450	S	*	2/2006	Schiesl-Griesinger	D11/4
D576,908	S	*	9/2008	Gruenke	D11/3
D663,230	S	*	7/2012	Fillon	D11/4
D707,149	S	*	6/2014	Ovadia	D11/5
D710,235	S	*	8/2014	Rummonds	D11/2
D716,174	S	*	10/2014	Tsang	D11/3
D720,642	S	*	1/2015	Coin	D11/3
D747,659	S	*	1/2016	Coin	D11/3
9,265,309	B2		2/2016	Zannella		

D757,593	S	*	5/2016	Dulien	D11/4
9,433,264	B2		9/2016	Ingimundarson		
9,474,342	B2		10/2016	Ingimundarson		
D771,869	S	*	11/2016	Dulien	D28/41
D773,733	S	*	12/2016	Dulien	D28/41
9,526,304	B2		12/2016	Ingimundarson		
9,538,818	B2		1/2017	Zannella		
D779,994	S	*	2/2017	Roberts	D11/3
D779,995	S	*	2/2017	Roberts	D11/3
D780,019	S	*	2/2017	Riviere	D11/34
D786,116	S	*	5/2017	Thor	D11/4
D793,272	S	*	8/2017	Tsang	D11/3
9,770,076	B2		9/2017	Ingimundarson		
9,775,413	B1		10/2017	Ingimundarson		
D805,418	S	*	12/2017	Lowe	D11/3
D805,943	S		12/2017	Zannella		
D807,220	S	*	1/2018	Fowler	D11/6
9,913,513	B2		3/2018	Ingimundarson		
D816,535	S	*	5/2018	Wittker	D11/16
D832,130	S	*	10/2018	Bostic	D11/4

* cited by examiner

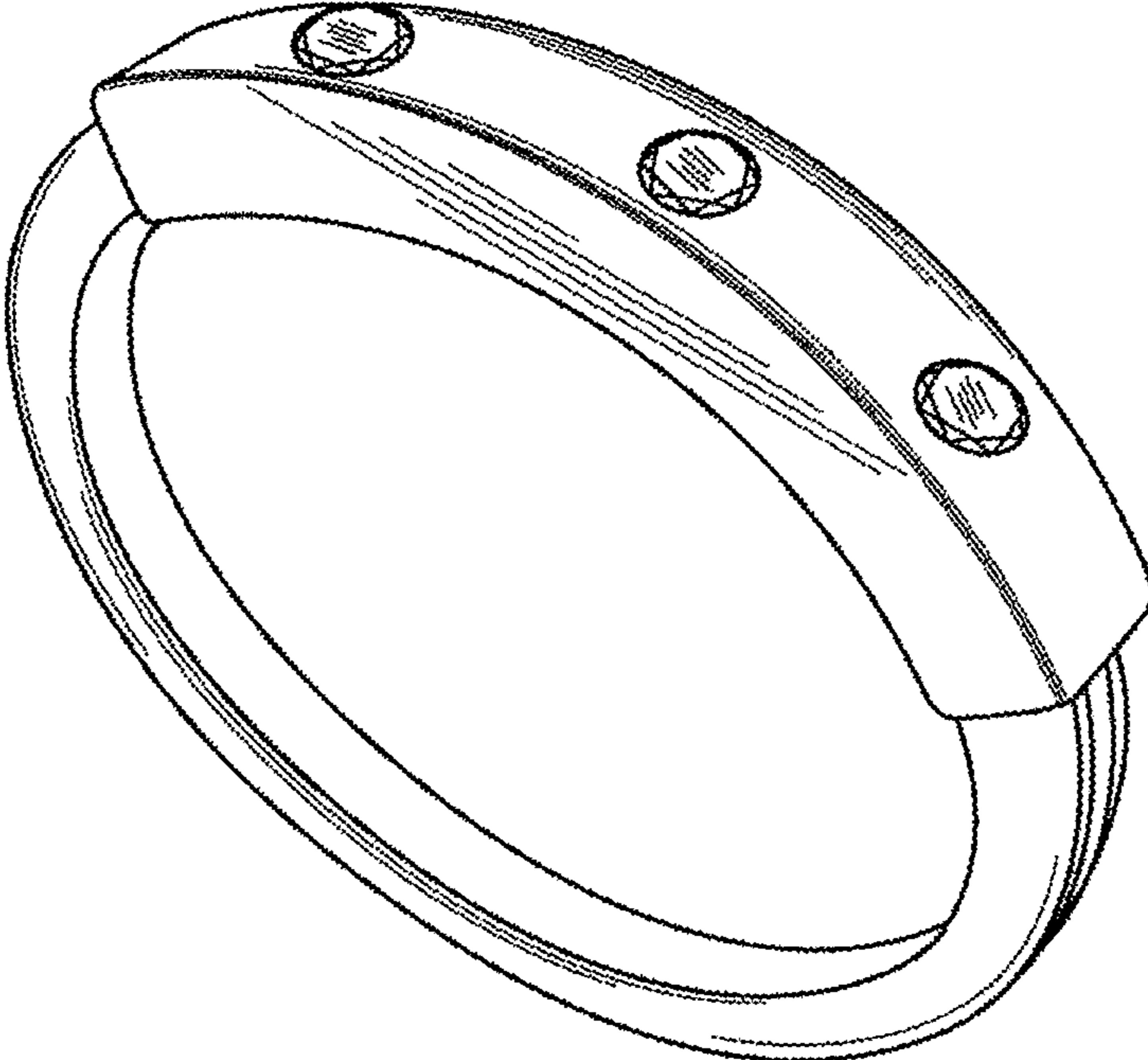

FIG. 1

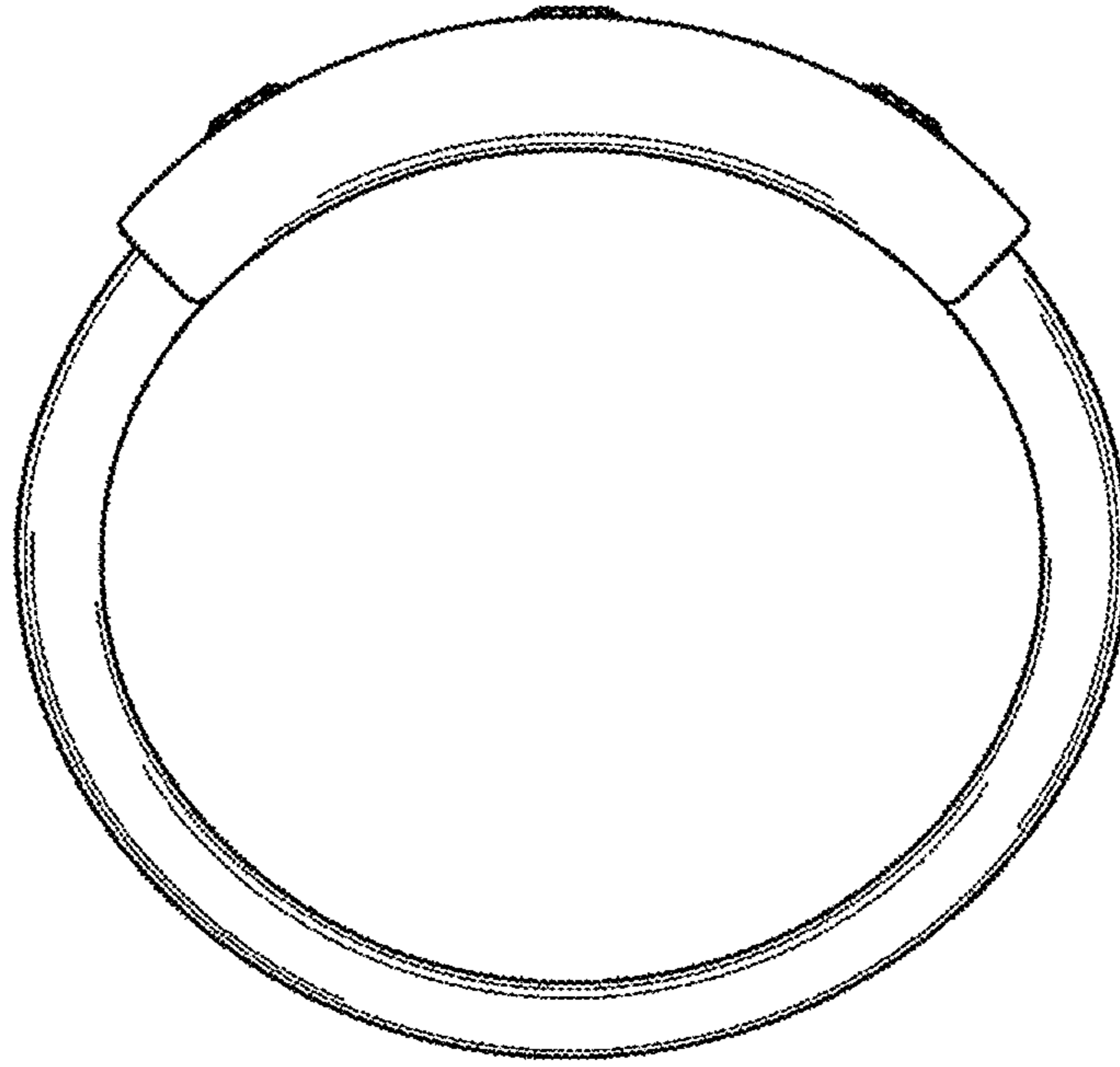

FIG. 2

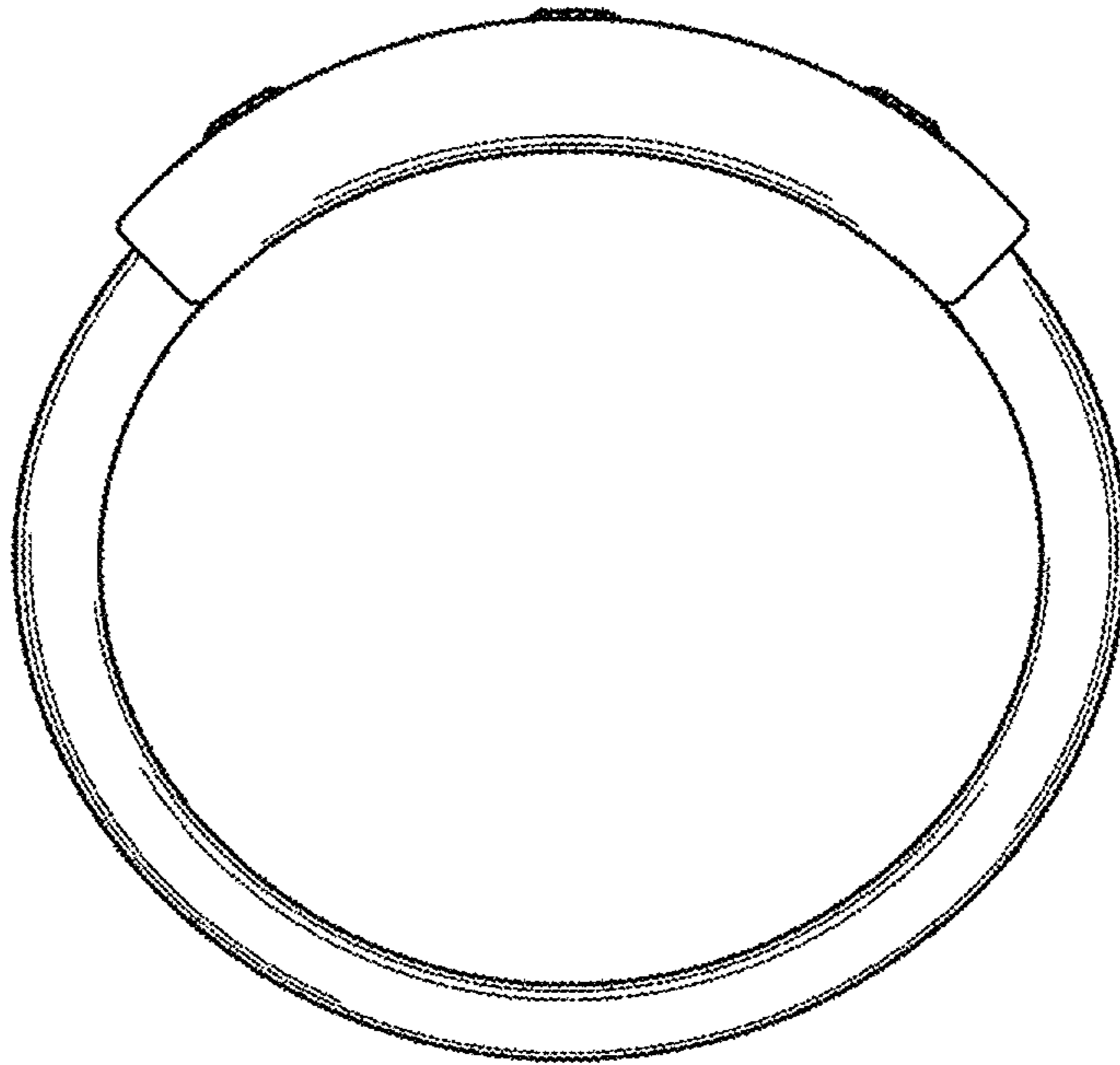

FIG. 3

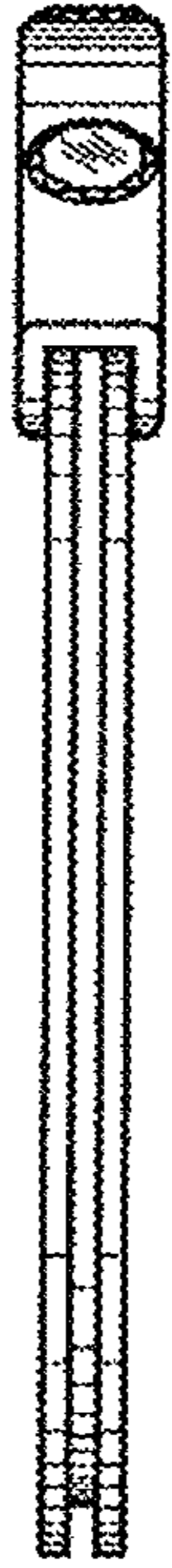

FIG. 4

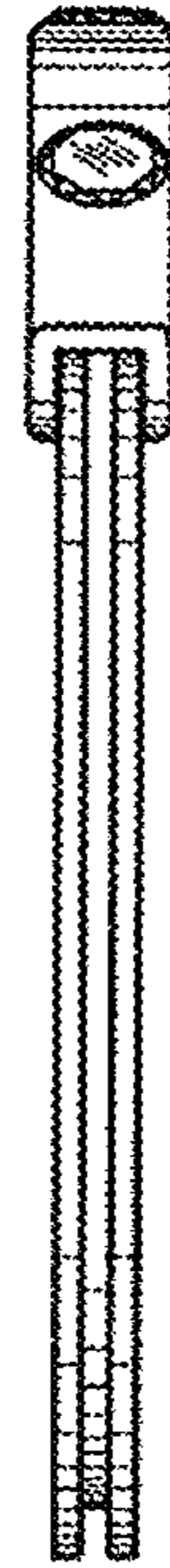

FIG. 5



FIG. 6

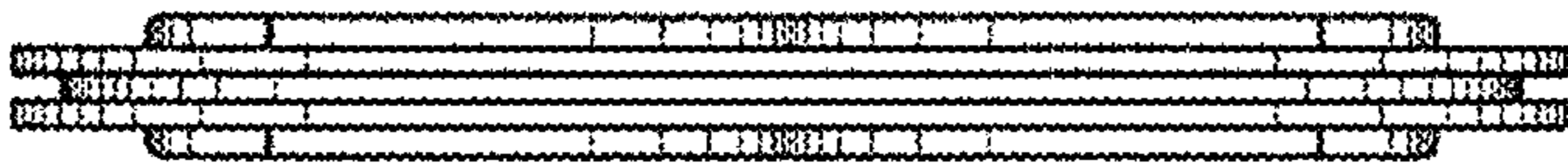

FIG. 7

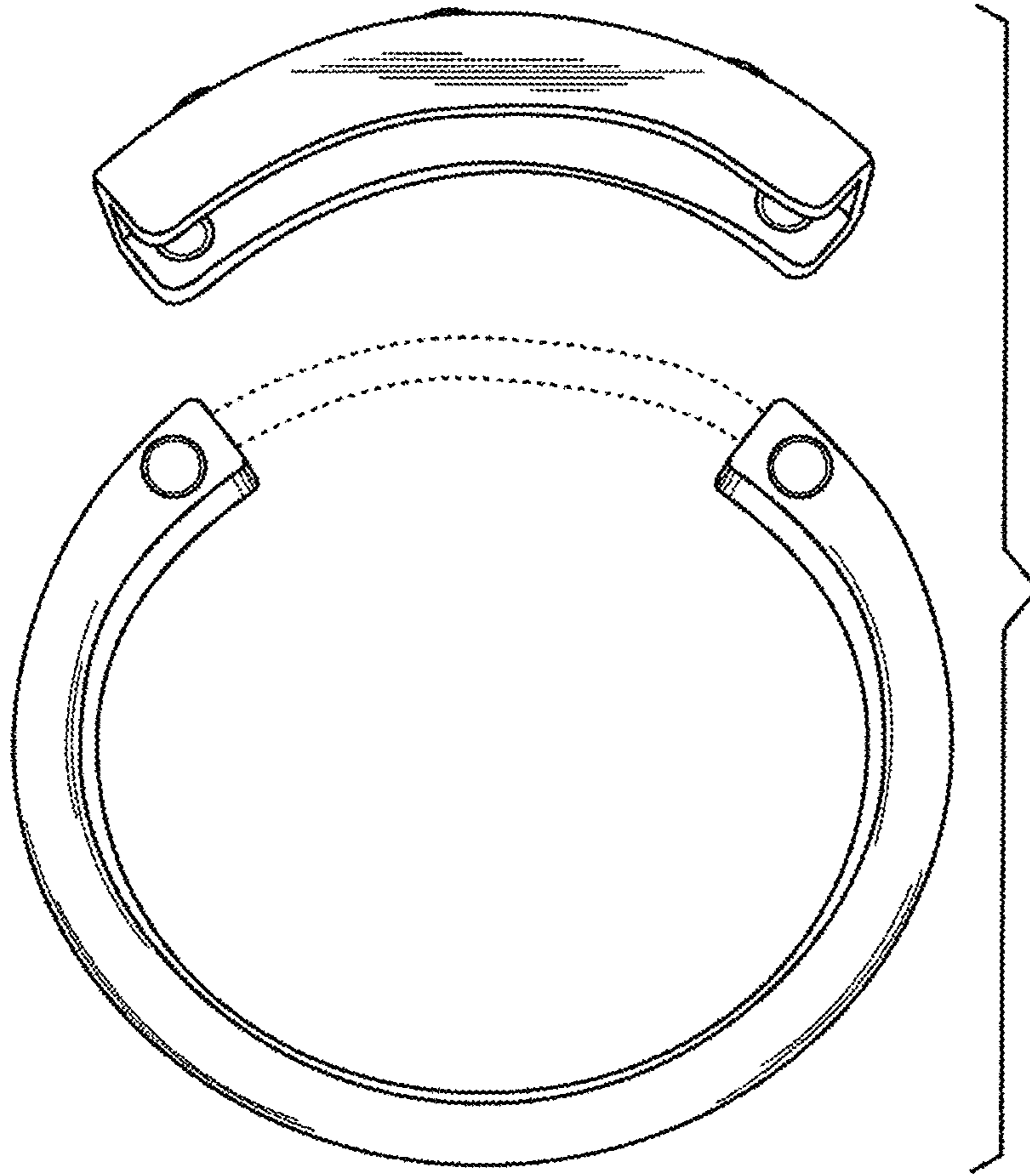

FIG. 8

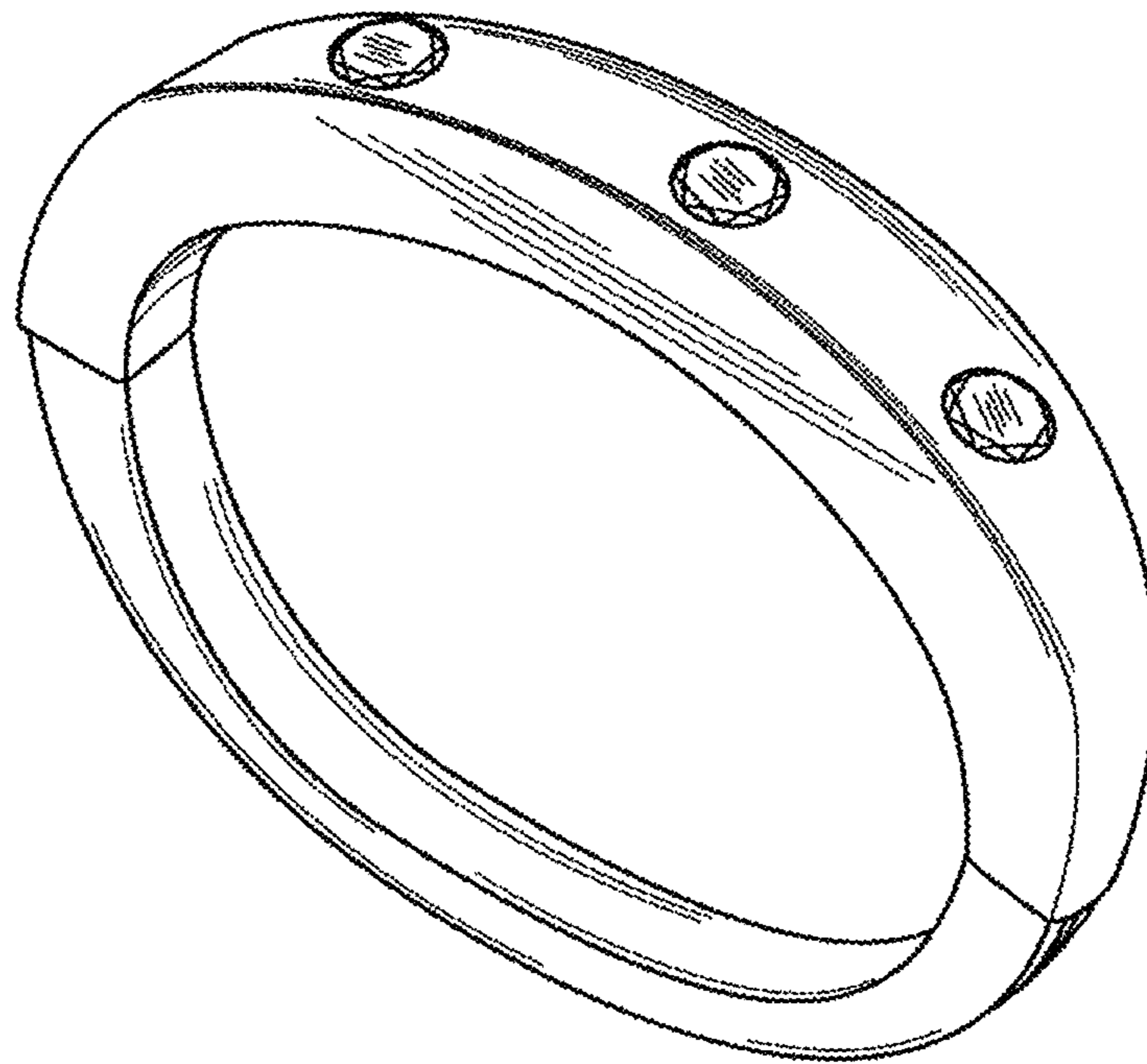

FIG. 9

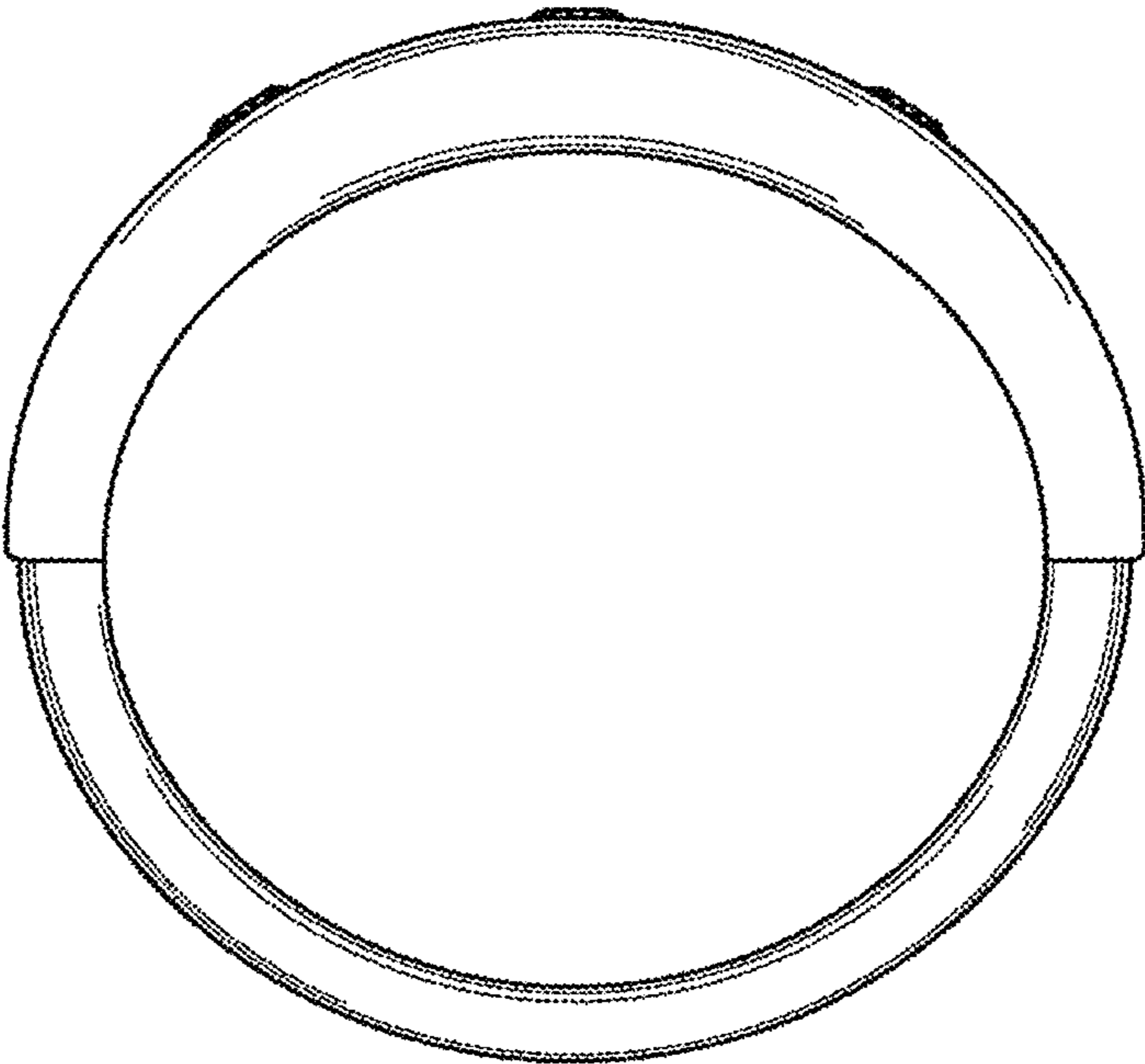

FIG. 10

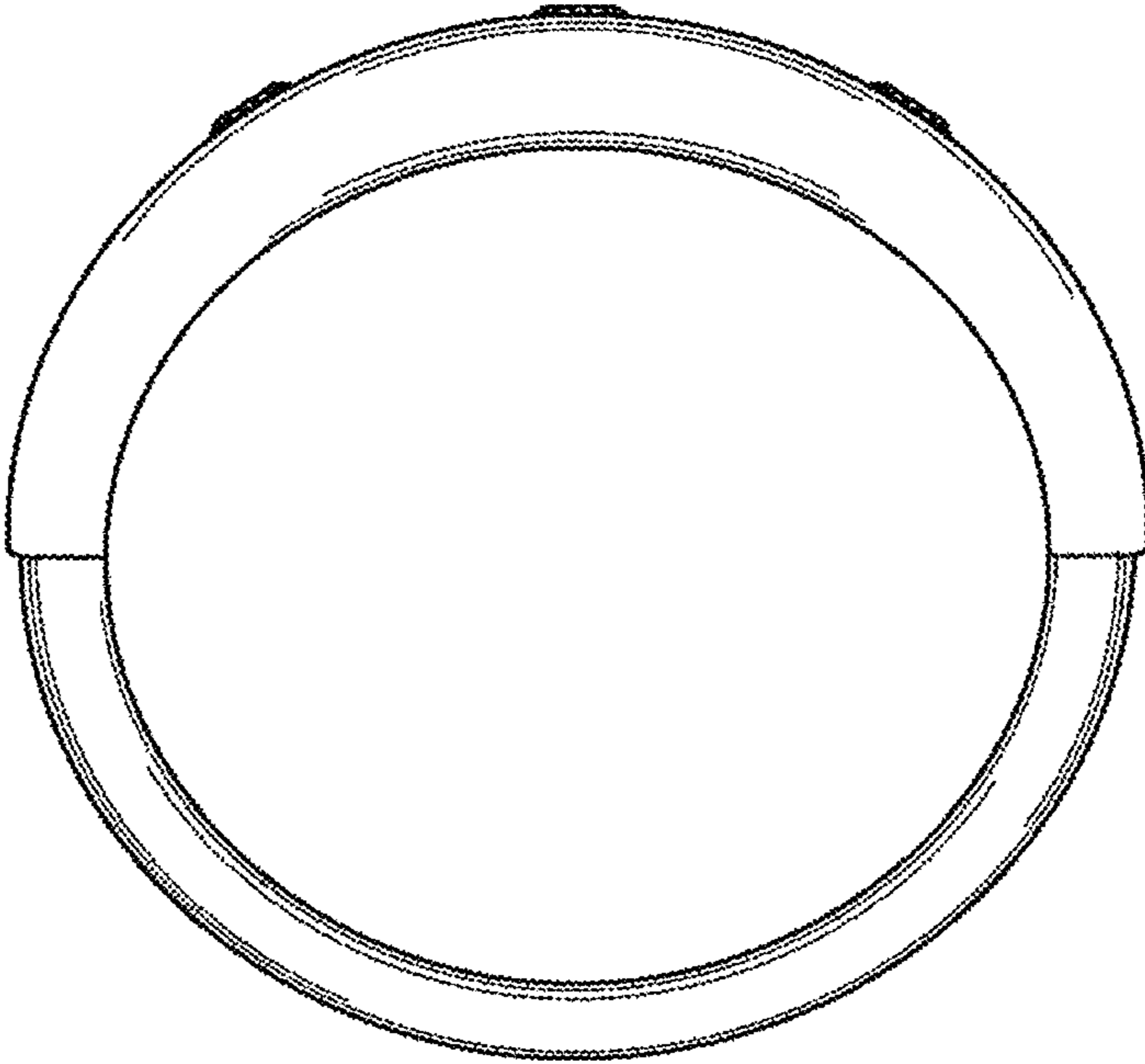

FIG. 11

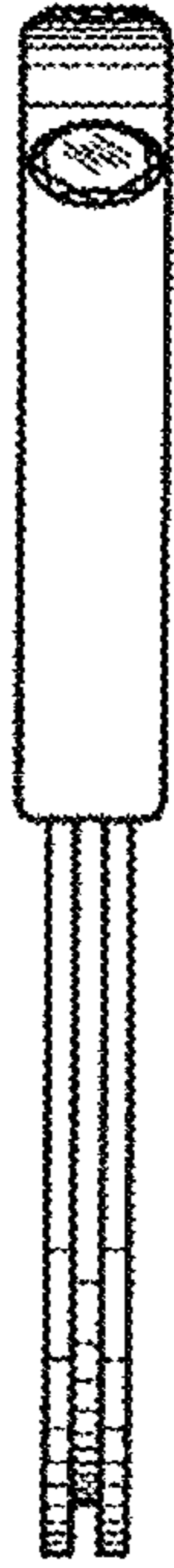

FIG. 12



FIG. 13



FIG. 14

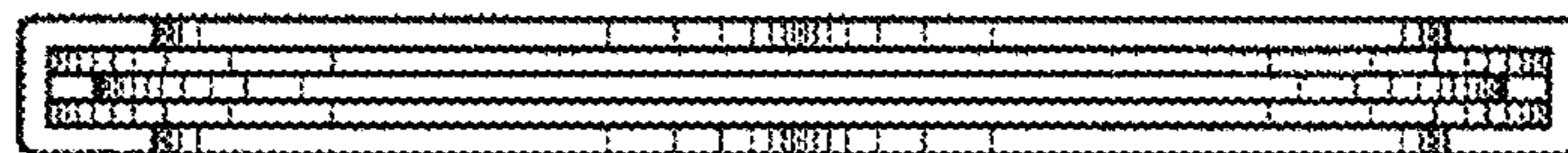

FIG. 15

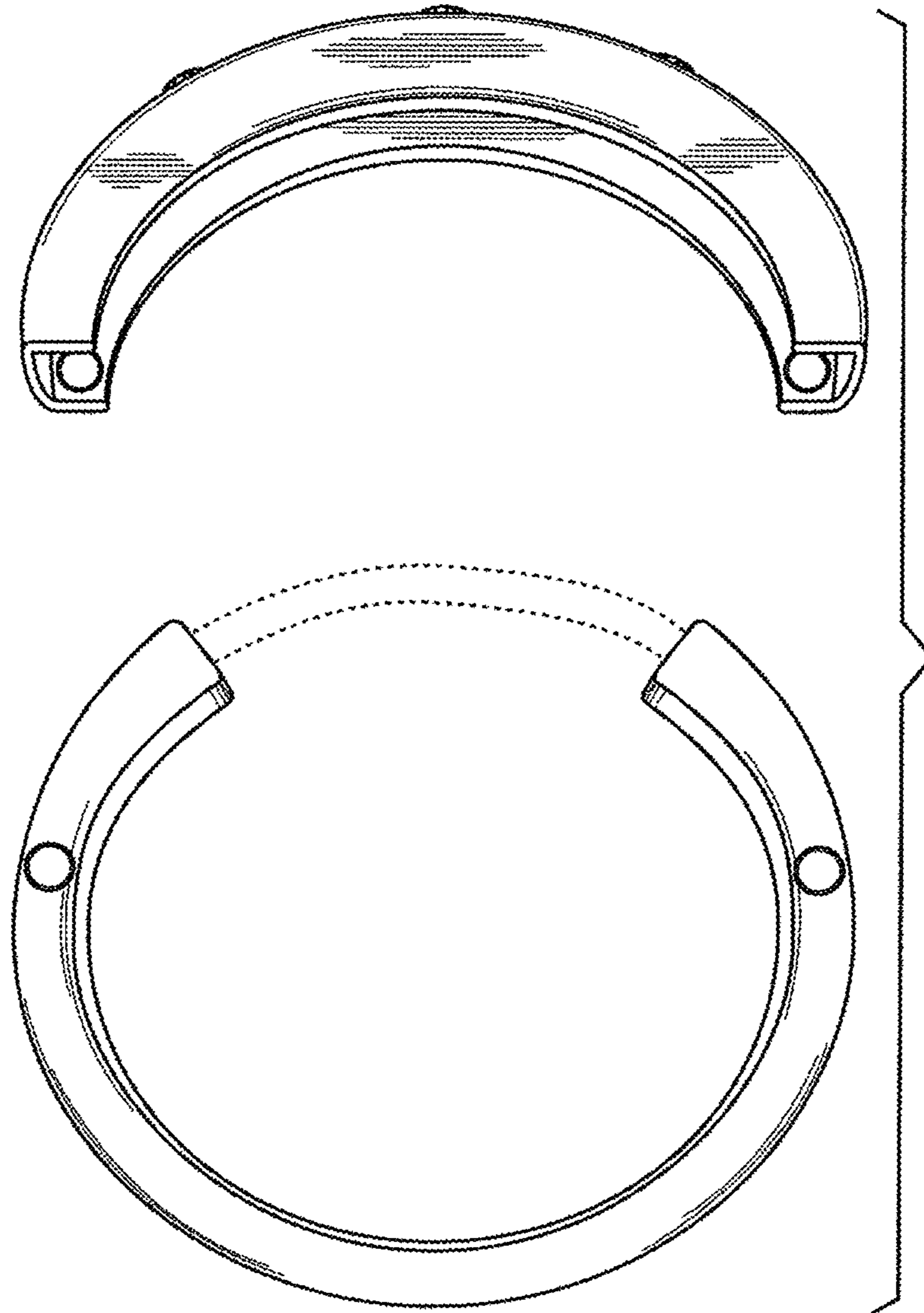

FIG. 16

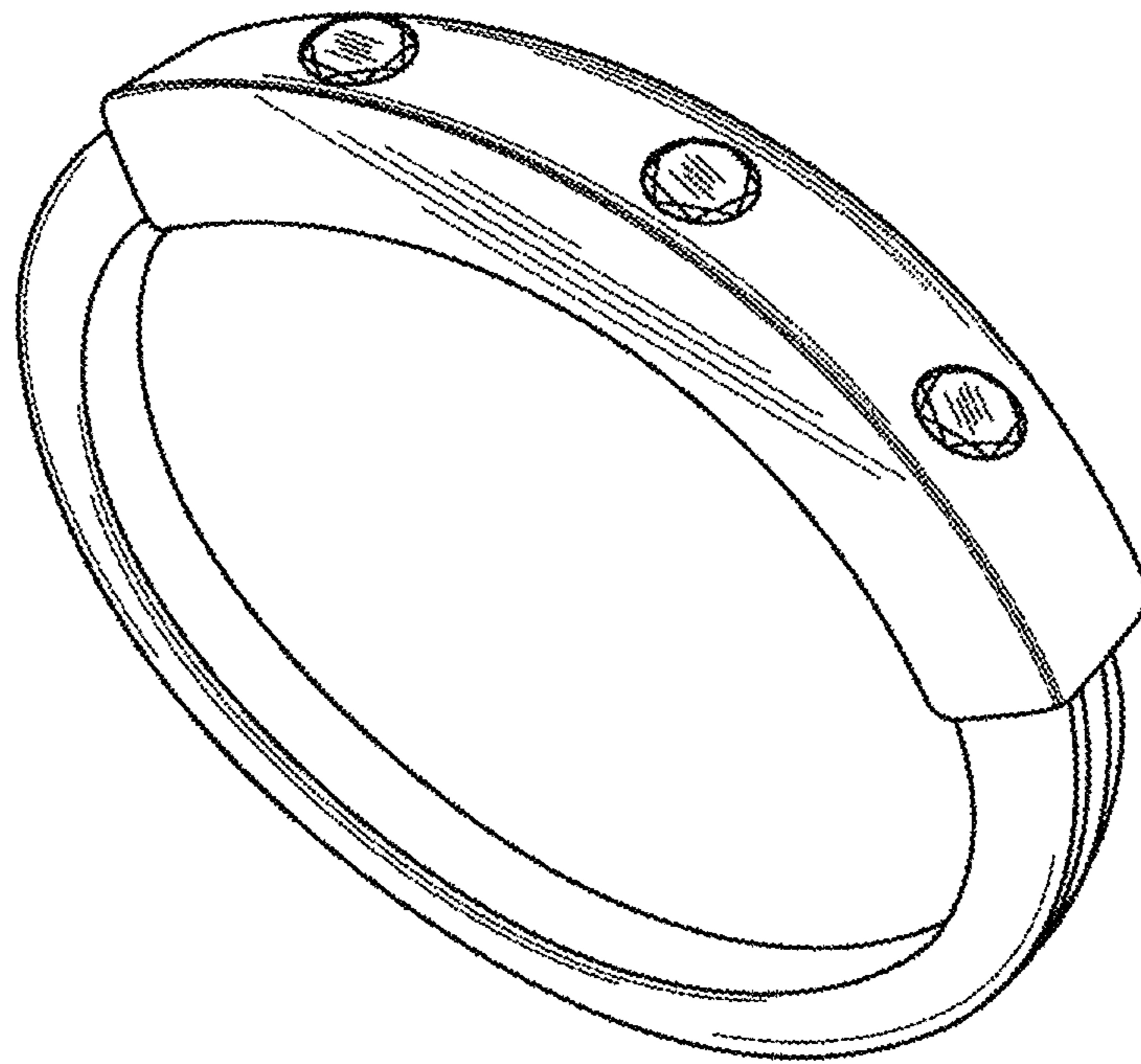

FIG. 17

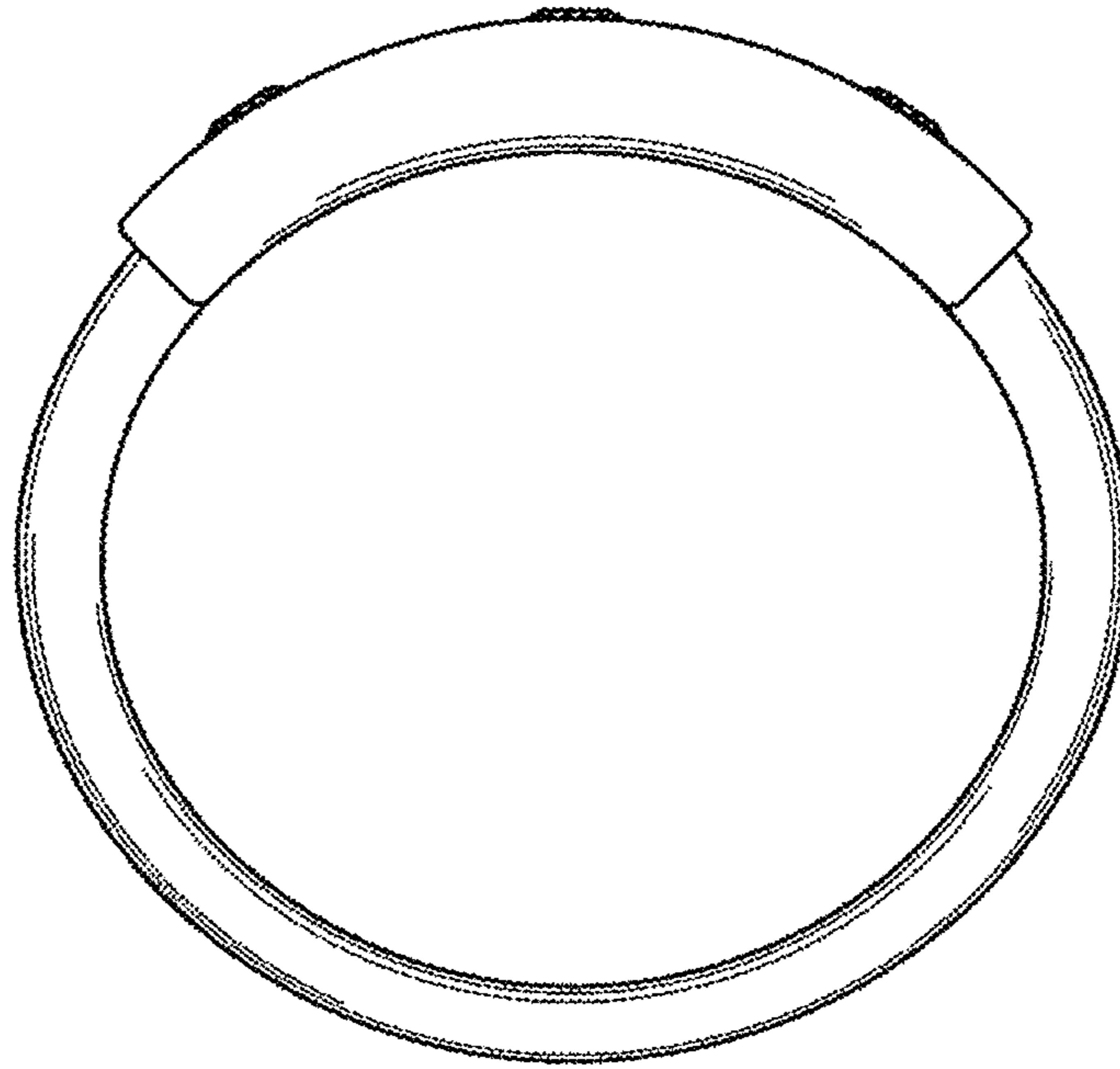

FIG. 18

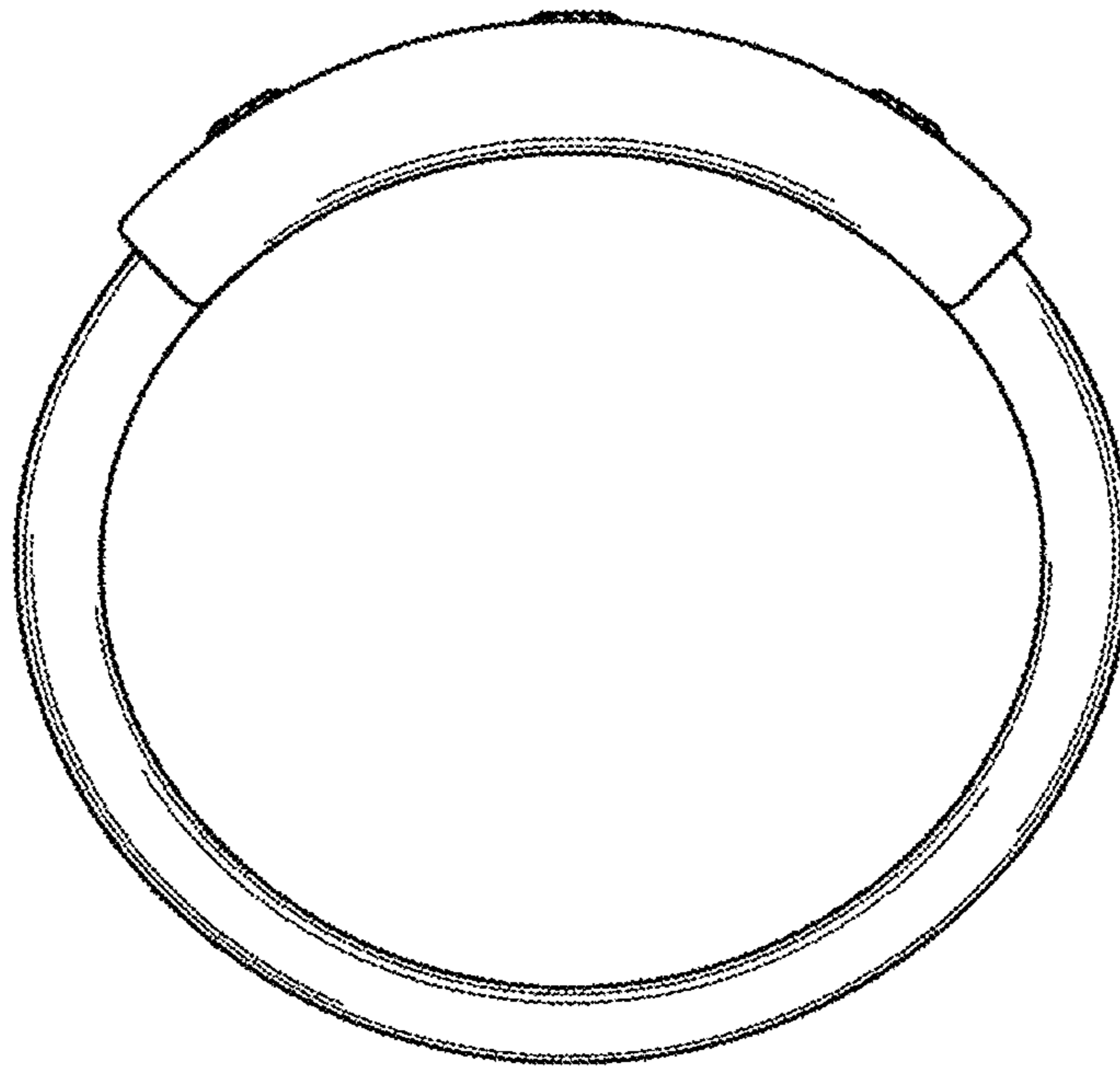

FIG. 19

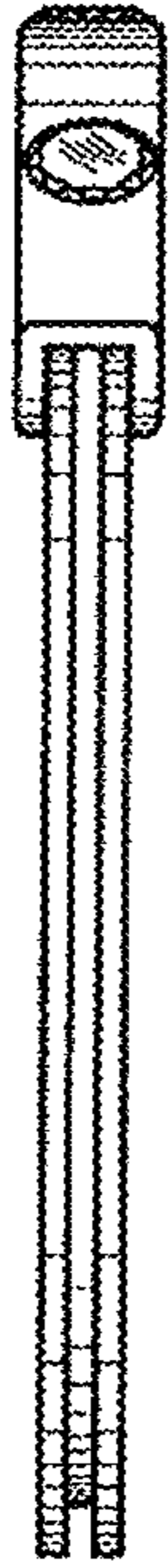

FIG. 20

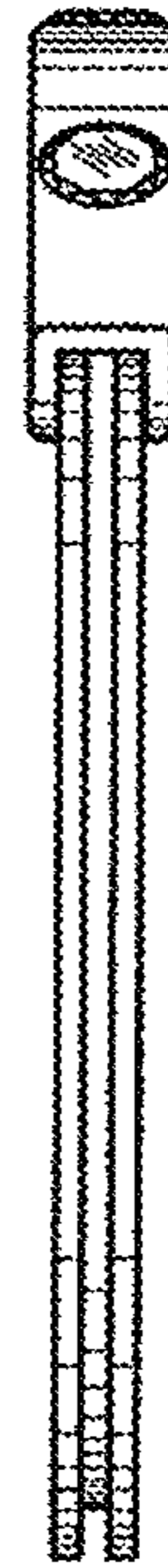

FIG. 21



FIG. 22

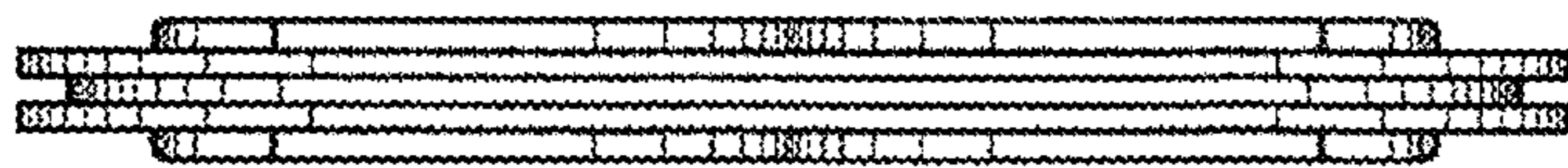

FIG. 23

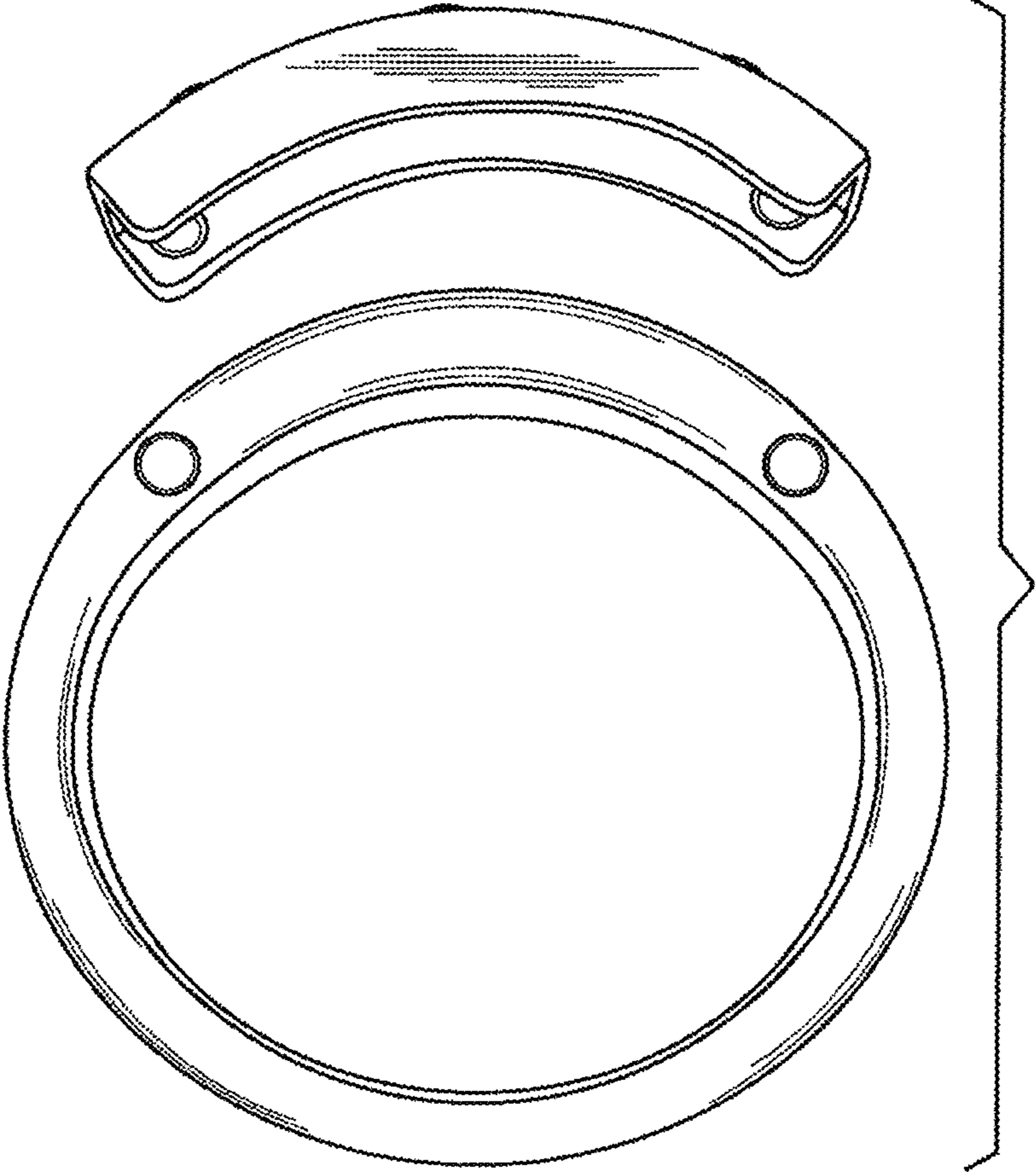

FIG. 24

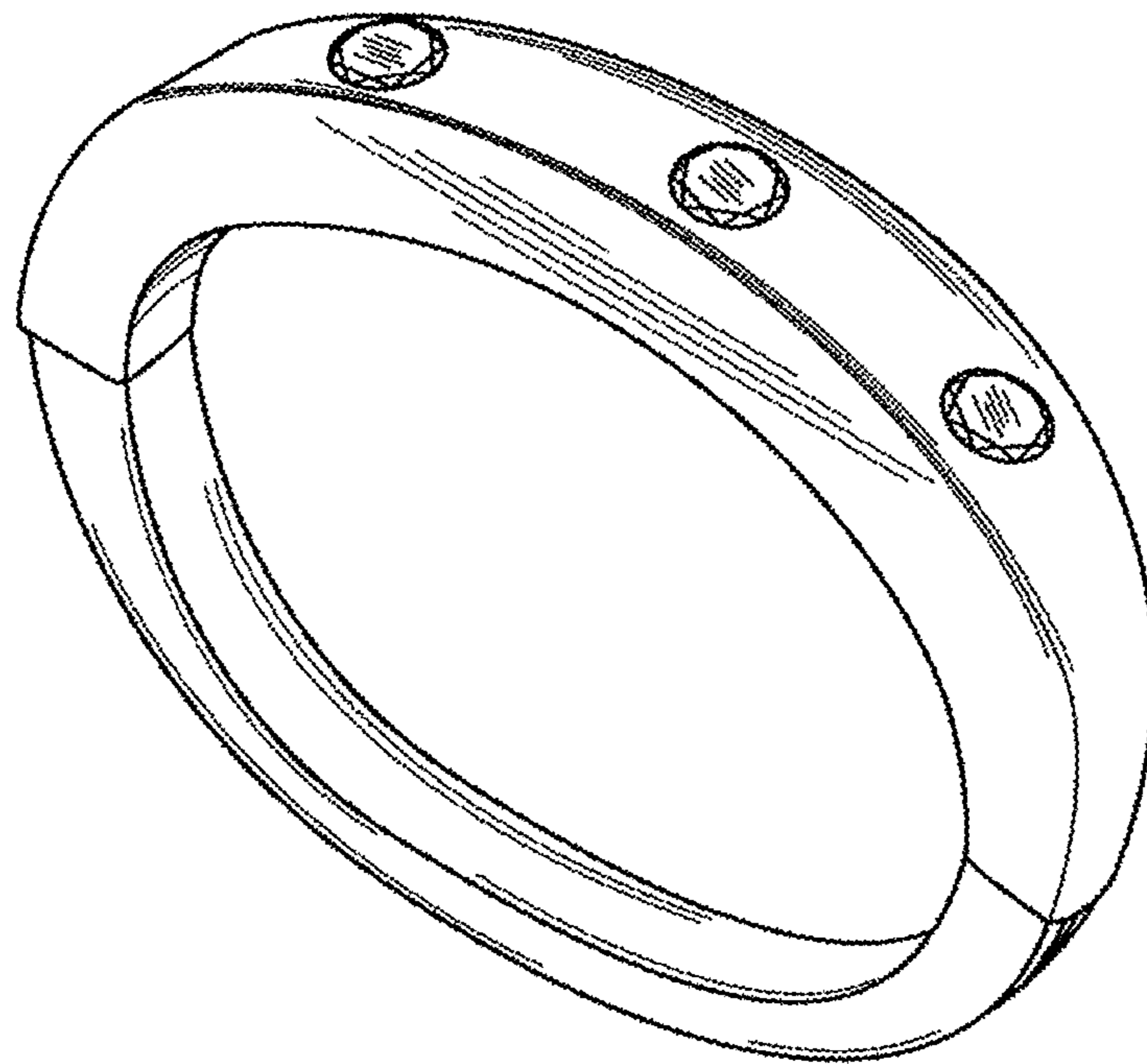

FIG. 25

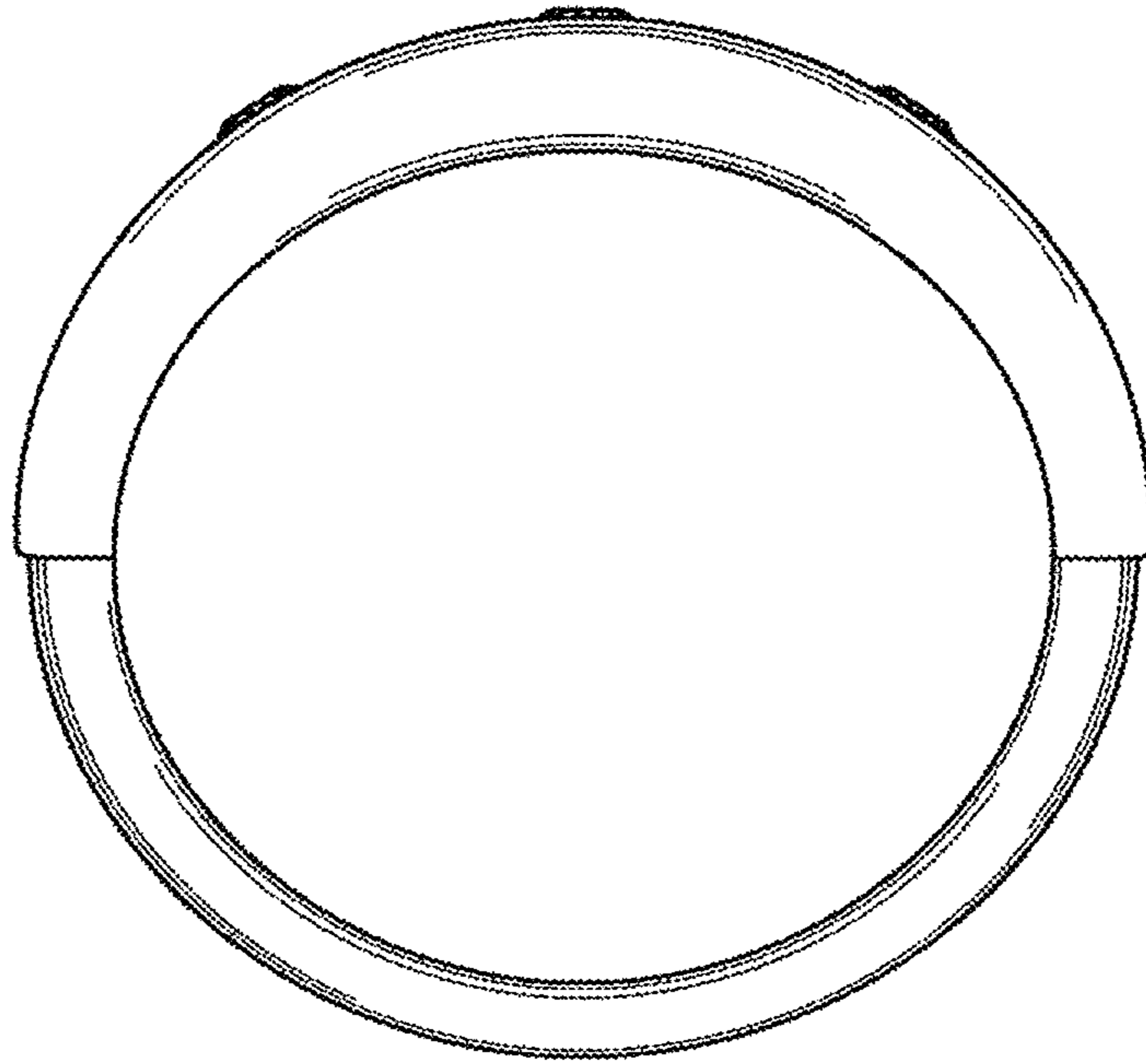

FIG. 26

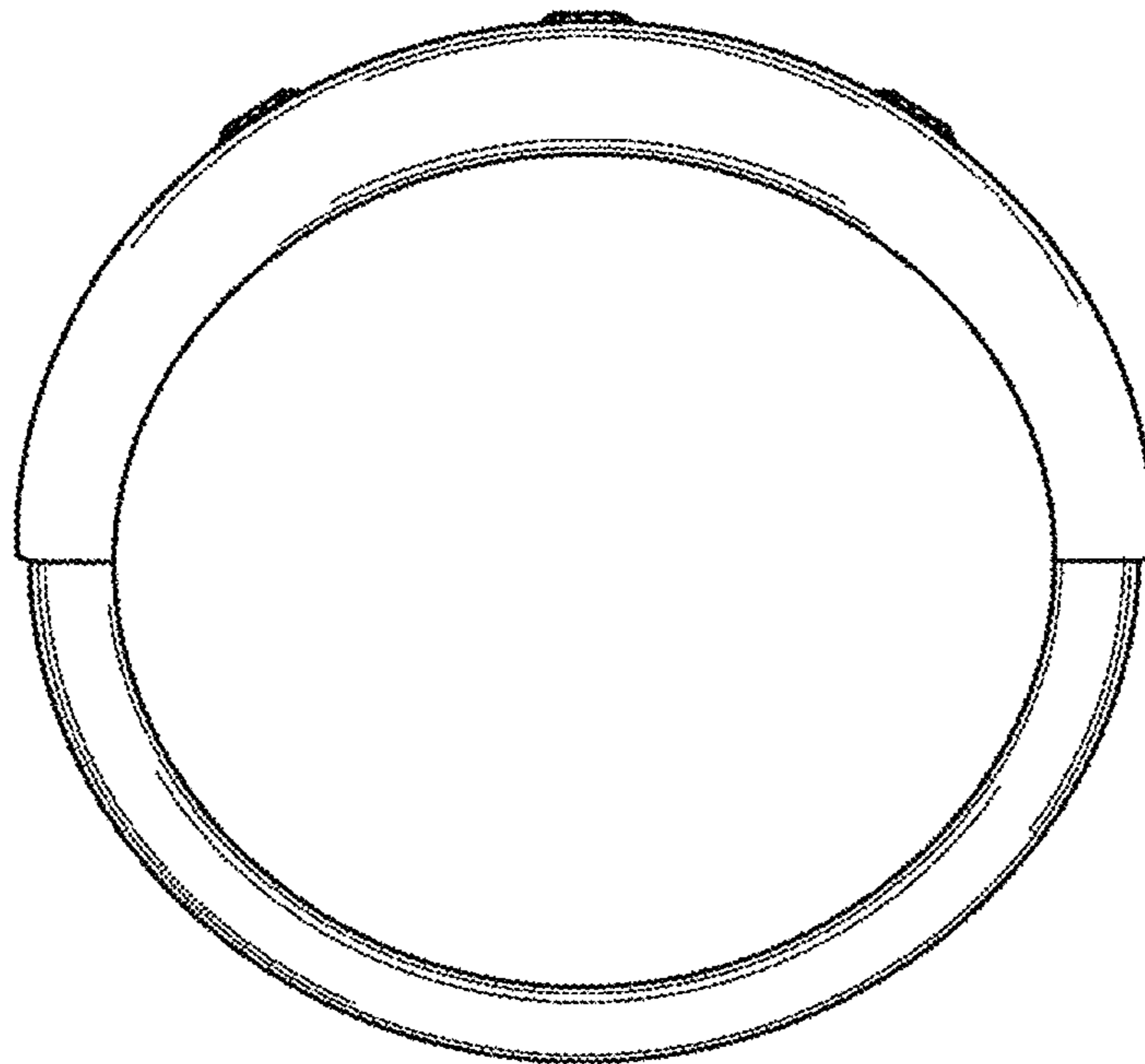

FIG. 27

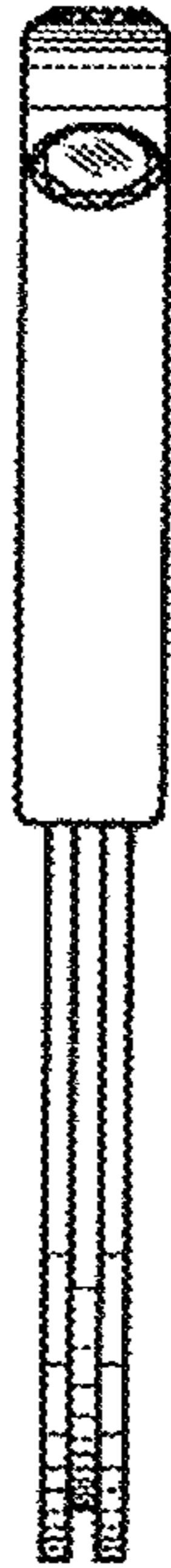

FIG. 28



FIG. 29



FIG. 30

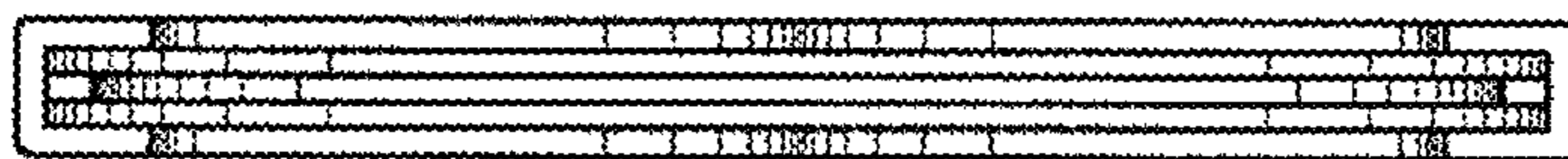

FIG. 31

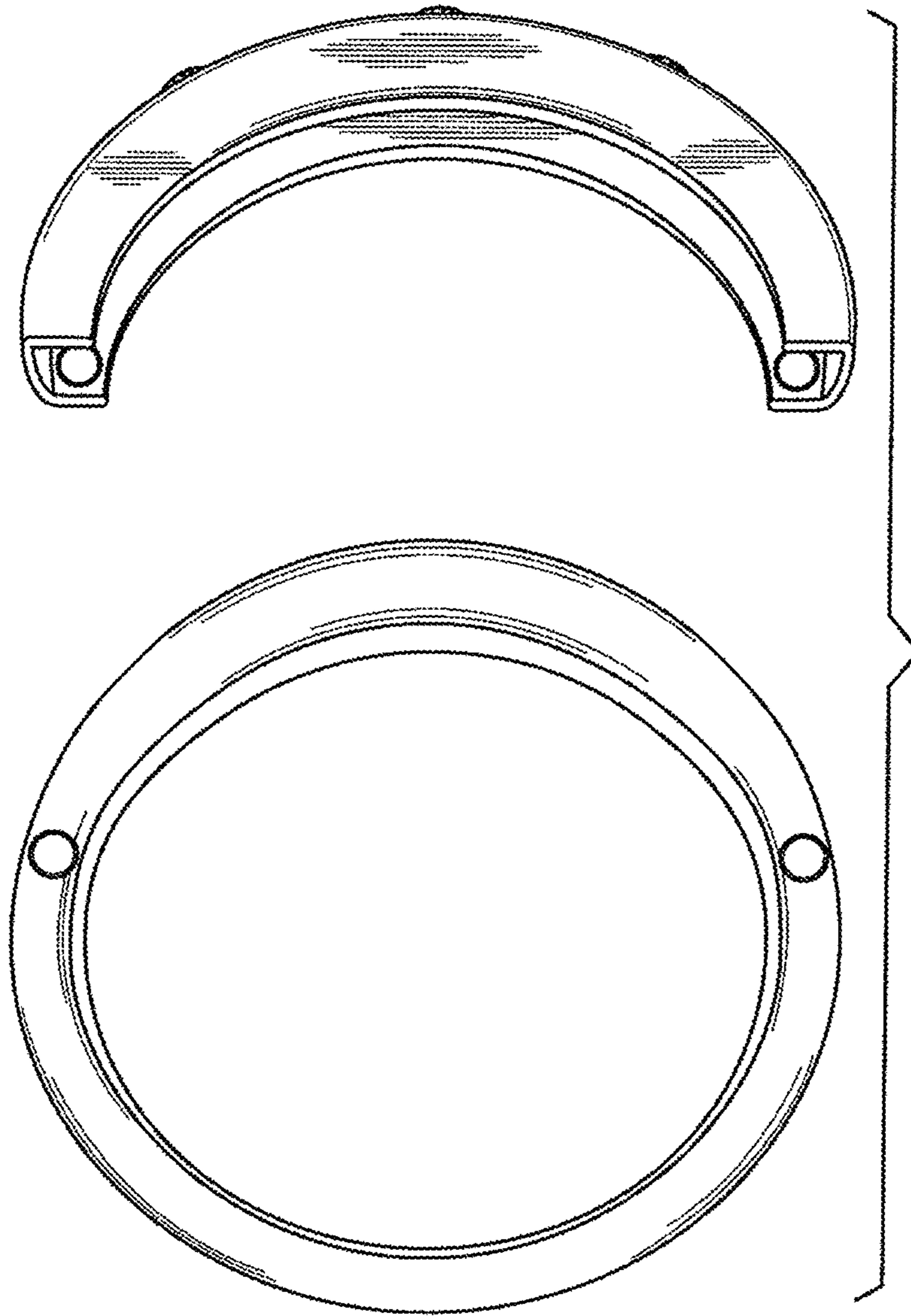

FIG. 32