



US00D902045S

(12) **United States Design Patent**
Brownell

(10) **Patent No.:** **US D902,045 S**

(45) **Date of Patent:** **** Nov. 17, 2020**

(54) **BOX CONTAINING SHAVING PRODUCTS**

(71) Applicant: **Societe BIC**, Clichy (FR)

(72) Inventor: **Matthew Brownell**, New York, NY (US)

(73) Assignee: **Societe BIC**, Clichy (FR)

(**) Term: **15 Years**

(21) Appl. No.: **29/680,903**

(22) Filed: **Feb. 21, 2019**

(51) **LOC (12) Cl.** **09-01**

(52) **U.S. Cl.**
USPC **D9/600**; D9/432

(58) **Field of Classification Search**
USPC D3/270, 271.1-271.4; D7/510, 514-520, D7/599, 604, 613, 619.2, 623, 628; D9/600, 652, 414-434; 206/457, 459.5, 206/527; 215/381-384, 400; D20/23-32
CPC B65D 5/42; B65D 5/4258; B65D 81/36; B65D 81/365; B65D 81/366; B65D 81/368; B65D 2203/00; B65D 2203/02; B65D 37/00; A63H 33/16; B32D 73/16; B32D 73/162; B32D 73/164

See application file for complete search history.

(56) **References Cited**

U.S. PATENT DOCUMENTS

| | | | | |
|--------------|---------|-----------|-------|--------|
| D276,136 S * | 10/1984 | Sebire | | D9/423 |
| D610,920 S * | 3/2010 | Bogdanova | | D9/434 |
| D637,486 S * | 5/2011 | Andrew | | D9/432 |
| D649,875 S * | 12/2011 | Graham | | D9/434 |
| D759,496 S * | 6/2016 | Damon | | D9/600 |
| D803,058 S * | 11/2017 | DiFranza | | D9/434 |
| D803,317 S * | 11/2017 | Sims | | D9/600 |
| D852,623 S * | 7/2019 | Sims | | D9/600 |

* cited by examiner

Primary Examiner — Sandra L Morris

(74) *Attorney, Agent, or Firm* — The H.T. Than Law Group

(57) **CLAIM**

The ornamental design for a box containing shaving products, as shown and described.

DESCRIPTION

FIG. 1 is a first perspective view of an ornamental design for a box containing shaving products according to the present invention;

FIG. 2 a second perspective view thereof;

FIG. 3 is a front view thereof;

FIG. 4 is a back view thereof;

FIG. 5 is a right side view thereof;

FIG. 6 is a left side view thereof;

FIG. 7 is a top view thereof;

FIG. 8 is a bottom view thereof

FIG. 9 is a first perspective view of another embodiment of an ornamental design for a box containing shaving products according to the present invention;

FIG. 10 is a second perspective view thereof;

FIG. 11 is a front view thereof;

The back view, the left and right views, and the top and bottom views of the second embodiment are the same as those from the first embodiment.

The broken line disclosure of the box illustrates the environment. The remaining broken lines illustrate background portions of the design of the shaver and of the shaving blade cartridge. None of the broken lines forms part of the claimed design.

FIGS. 1-3, 5-6 and 9-11 show that the box has a lighter stipple shading representing a first color and a darker stipple shading representing a second color, which is different than or contrasting the first color.

1 Claim, 9 Drawing Sheets

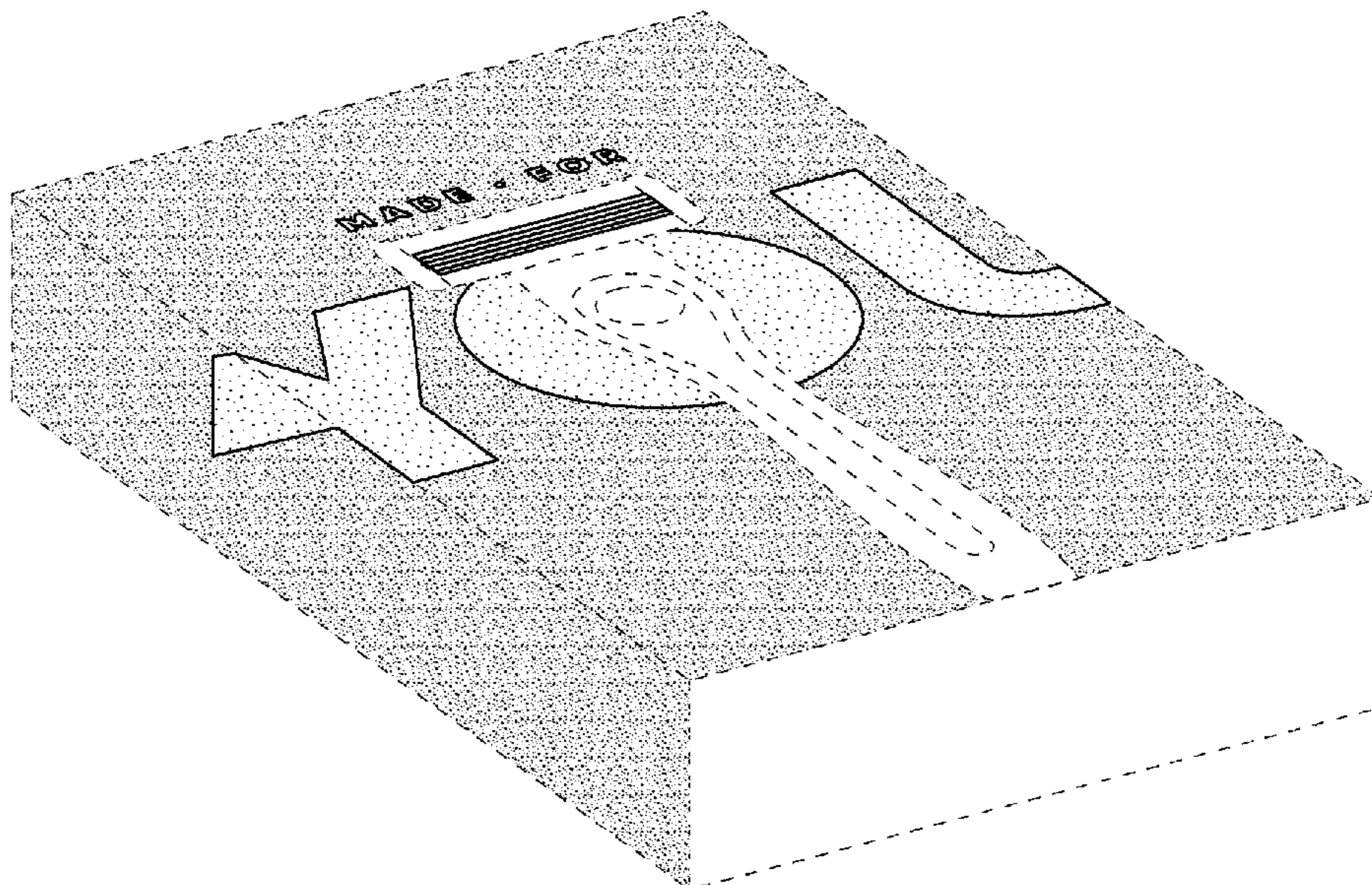

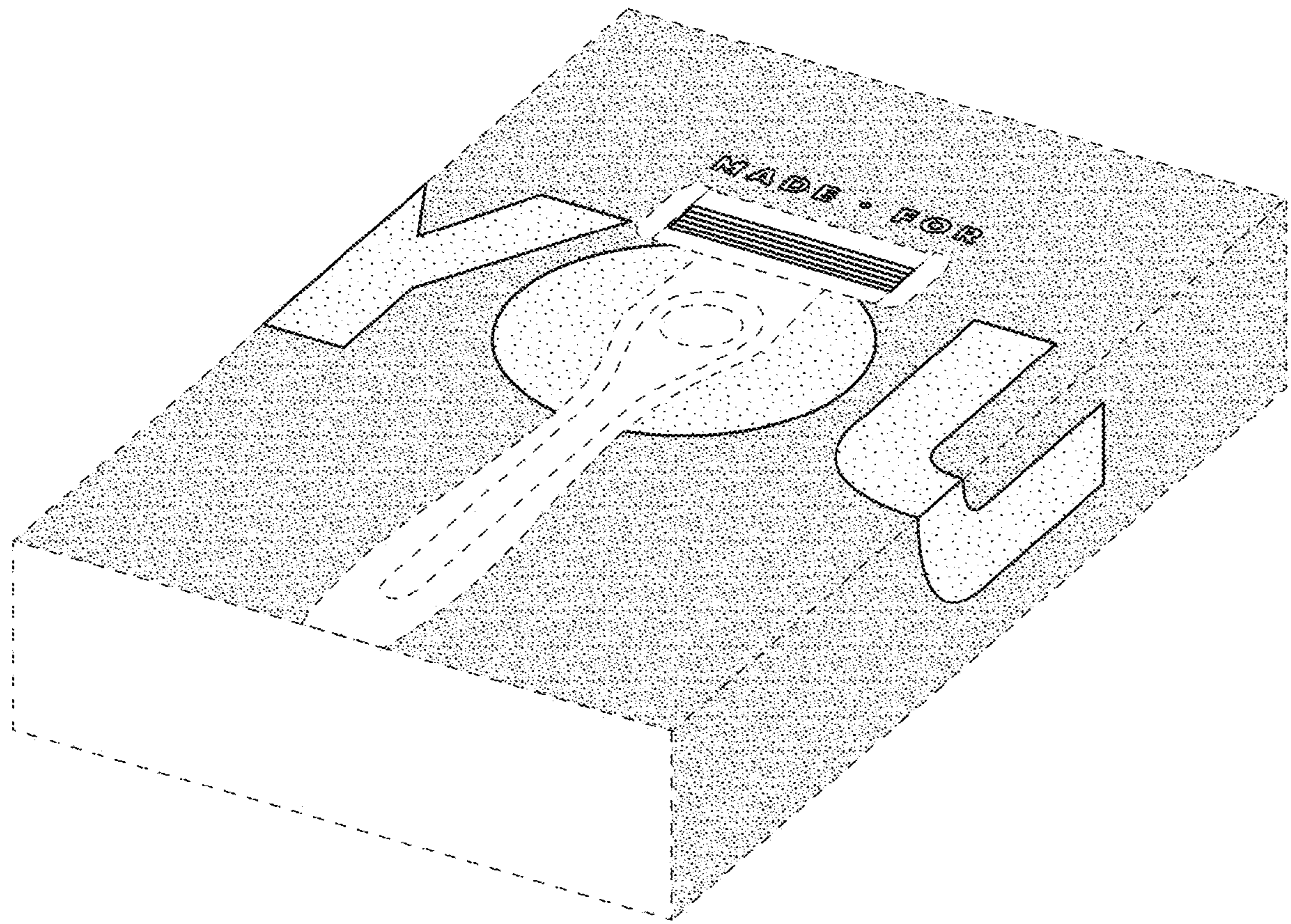

Fig. 1

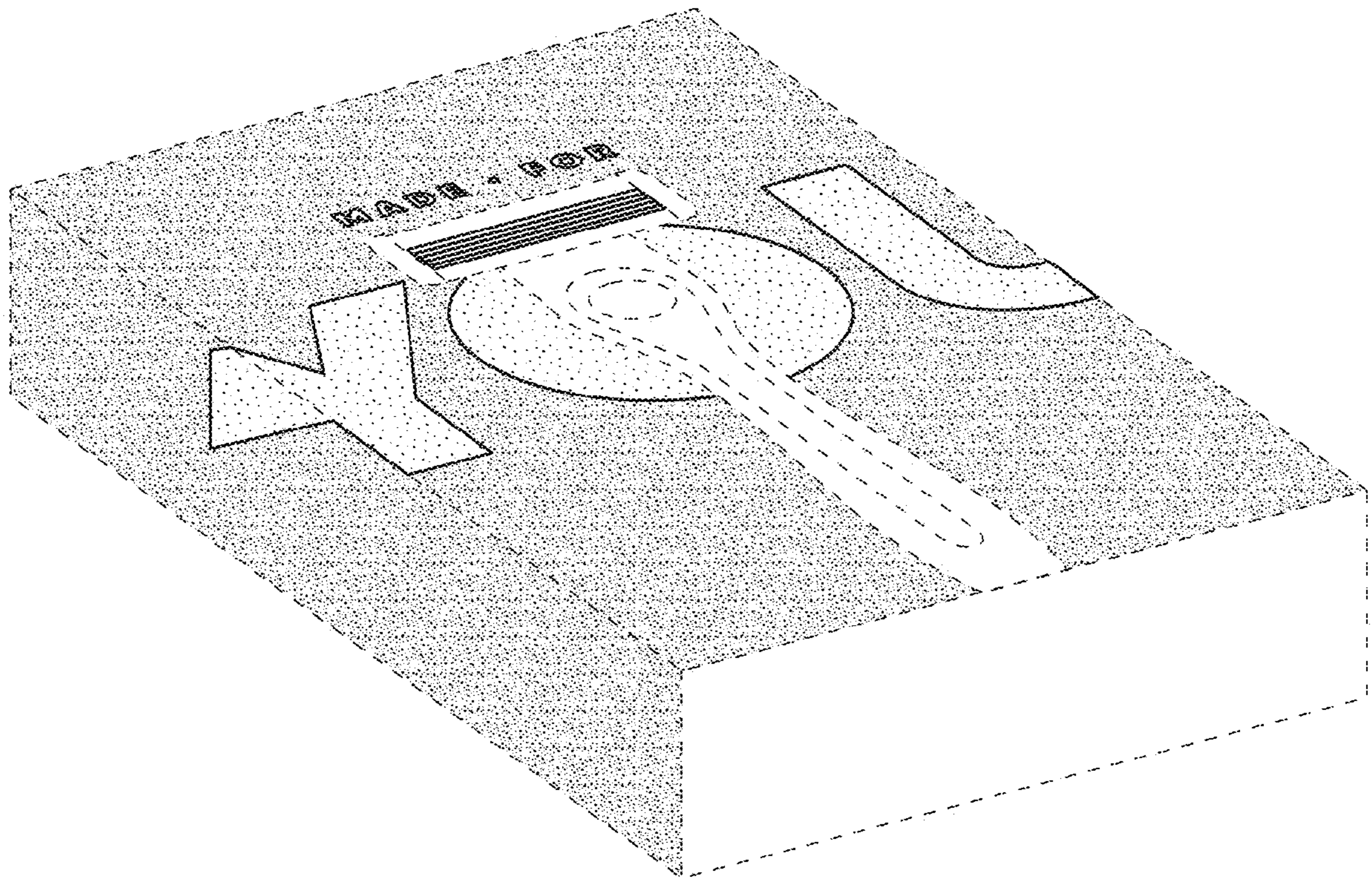

Fig. 2

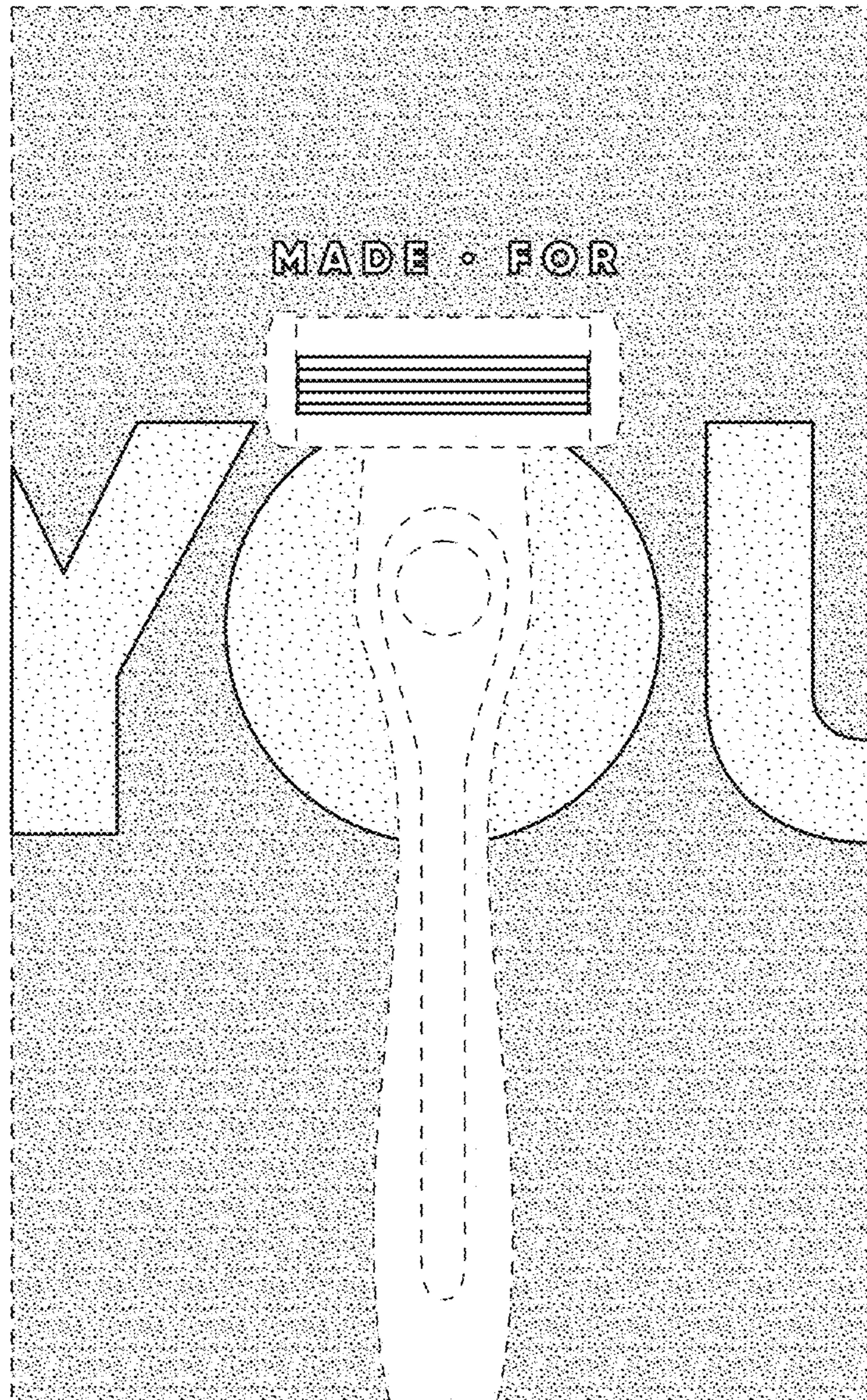

Fig. 3

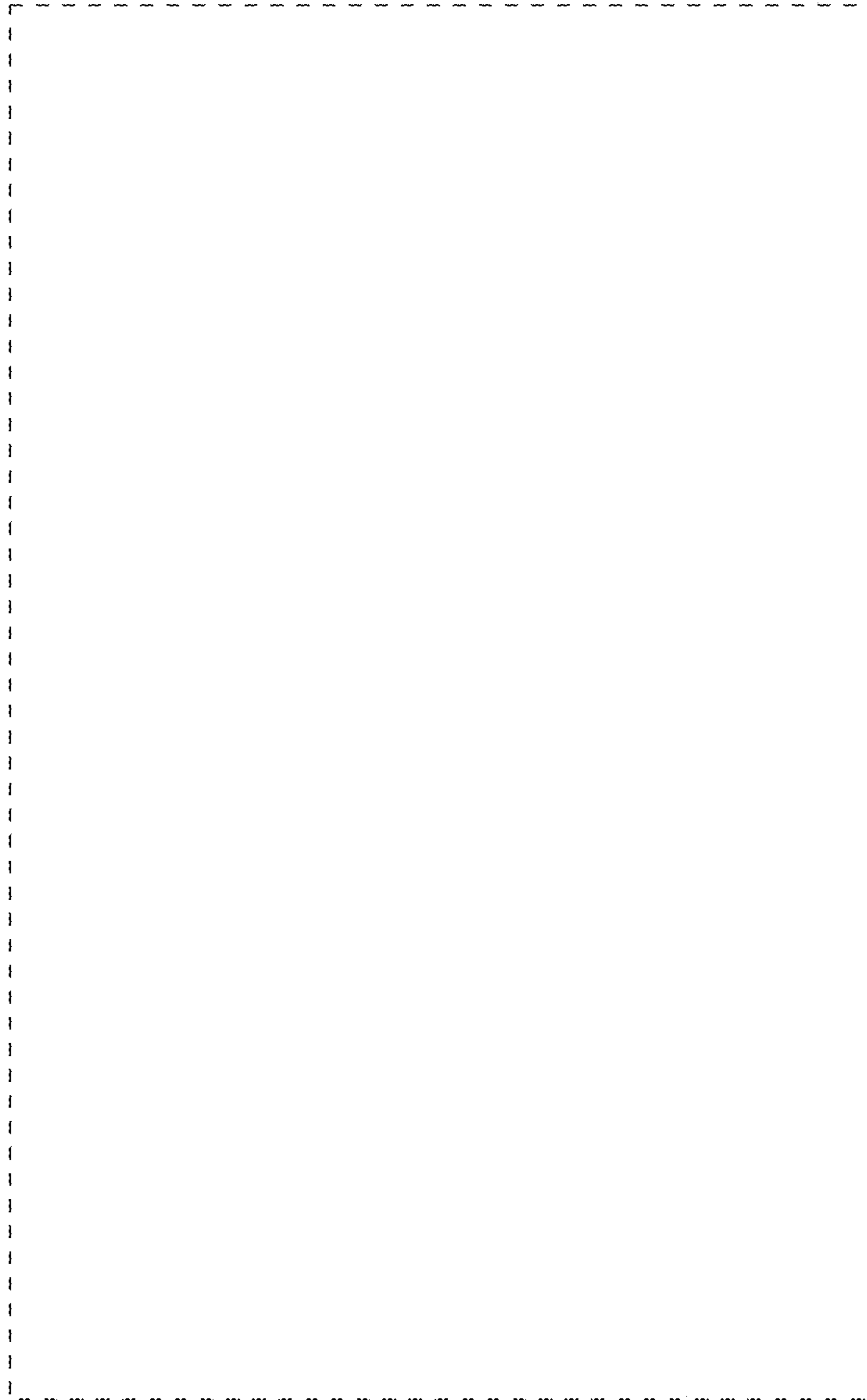

Fig. 4

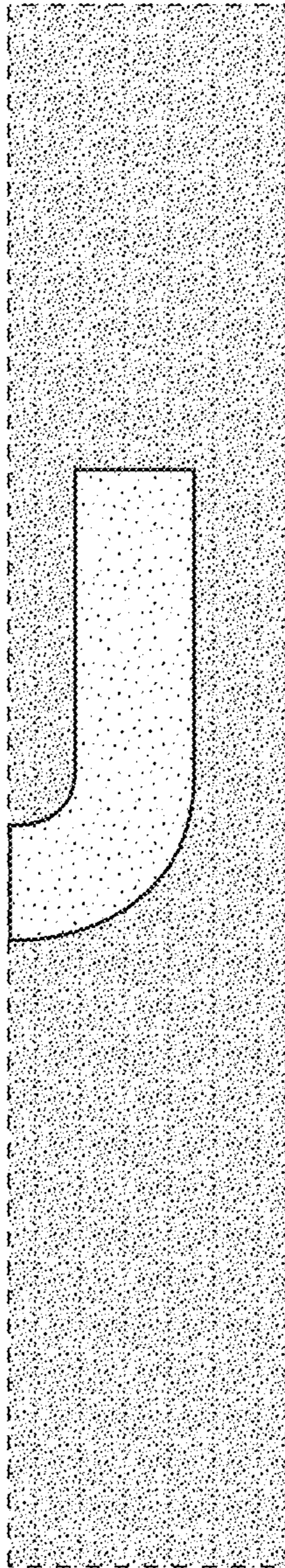

FIG. 5

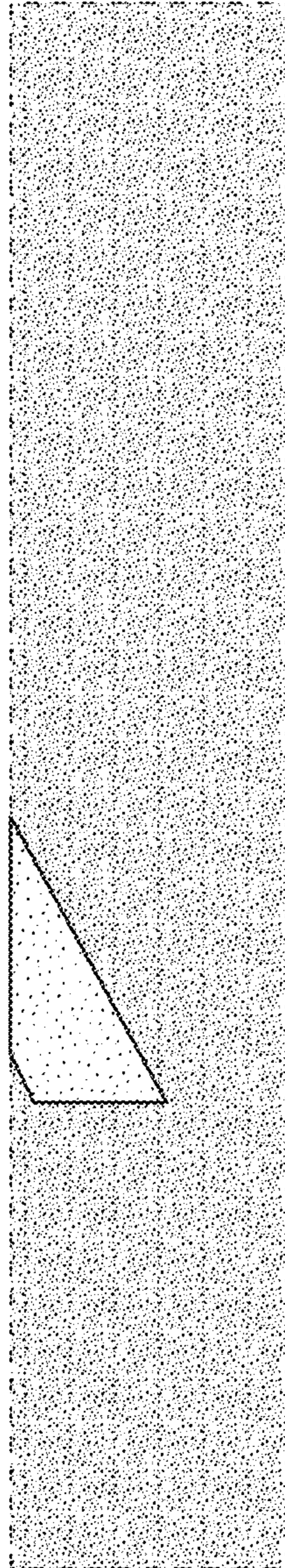

FIG. 6

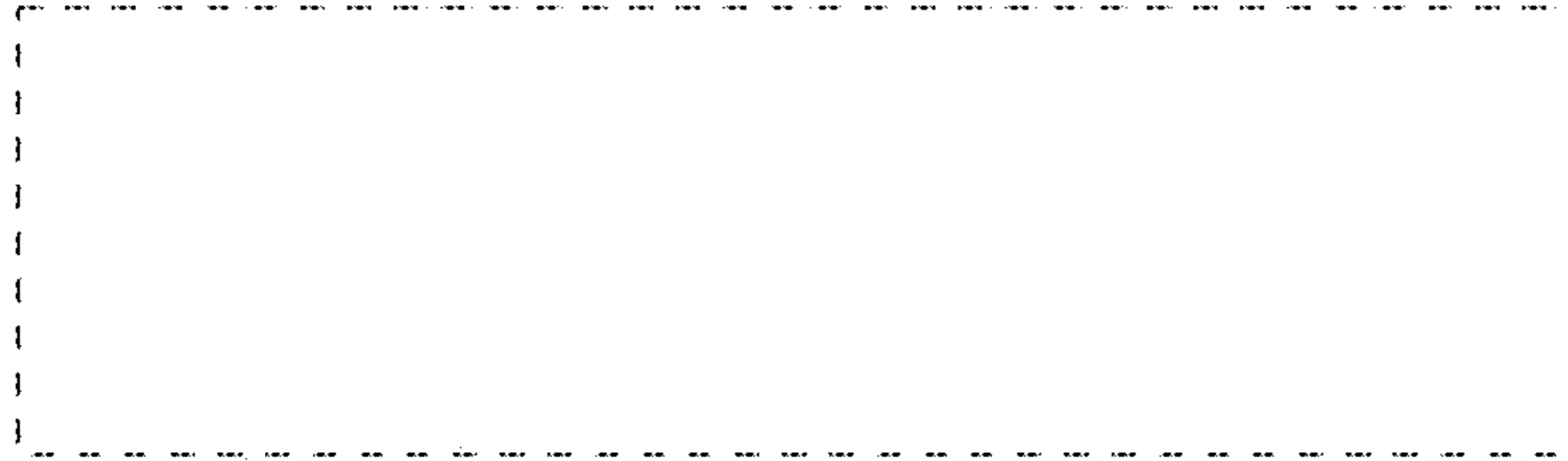

Fig. 7

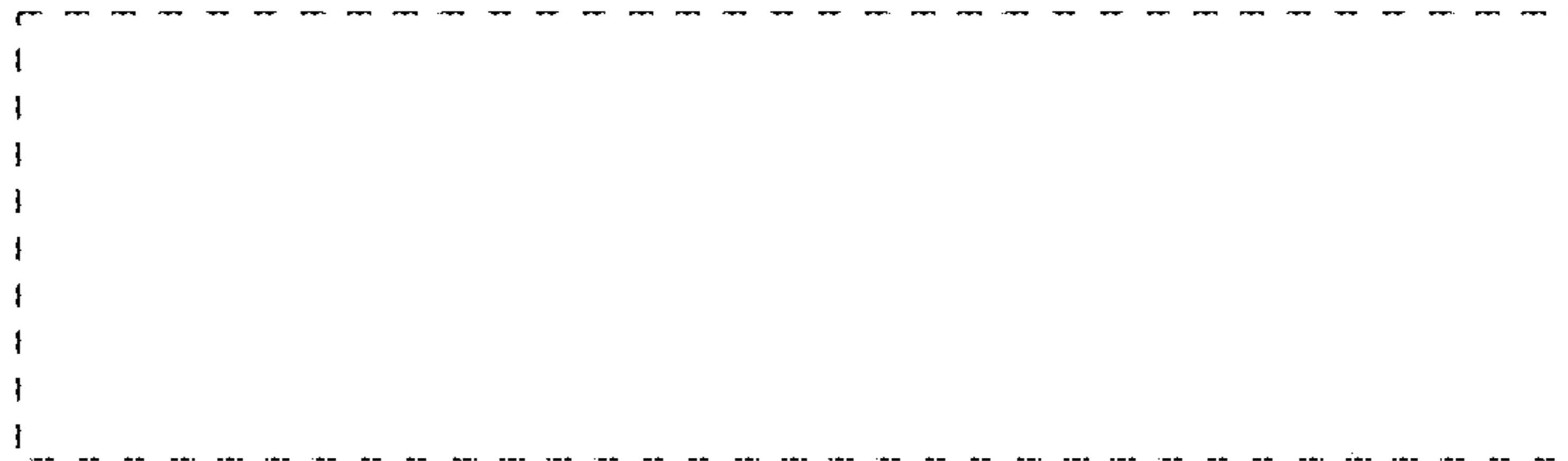

Fig. 8

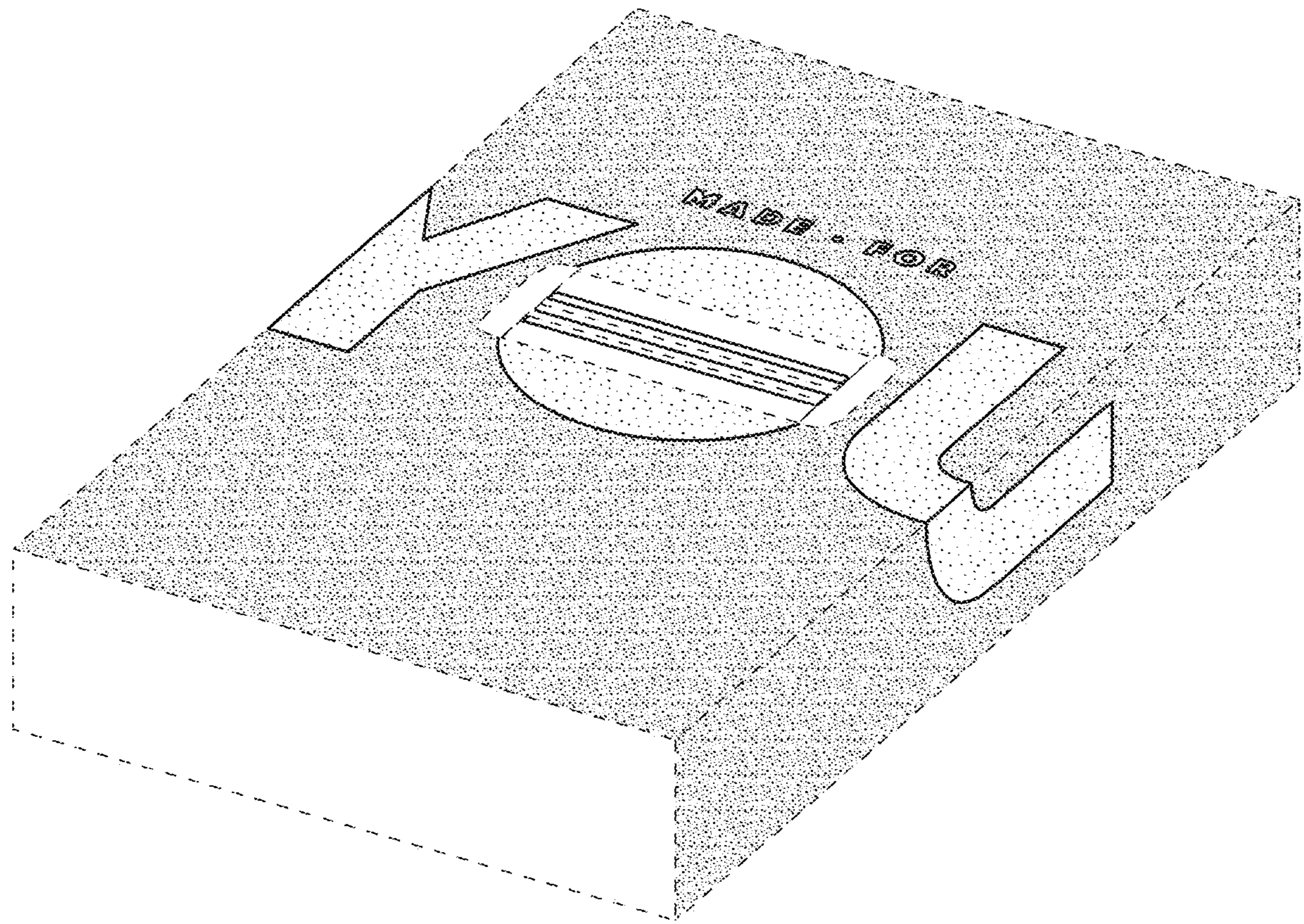

Fig. 9

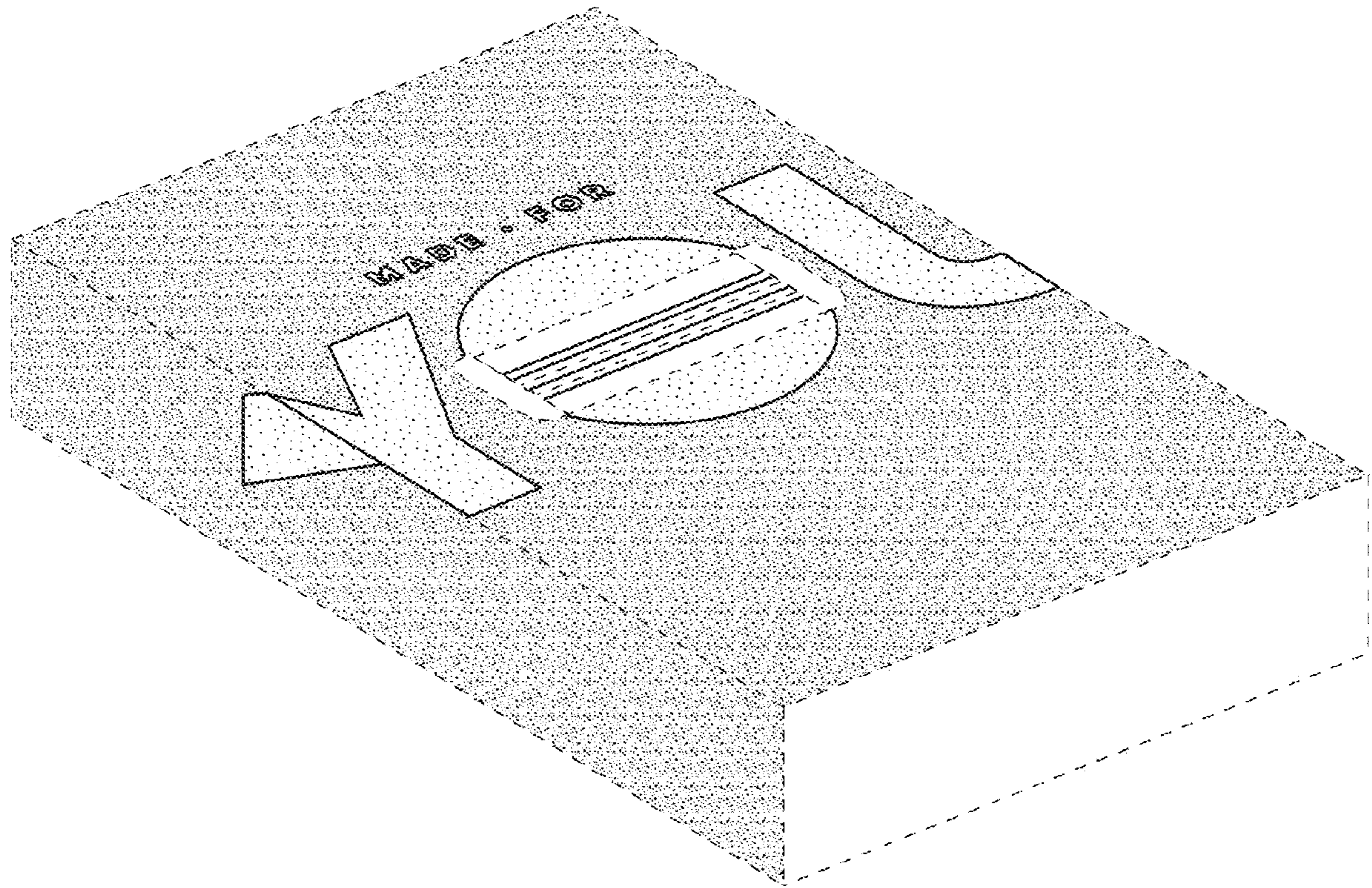

Fig. 10

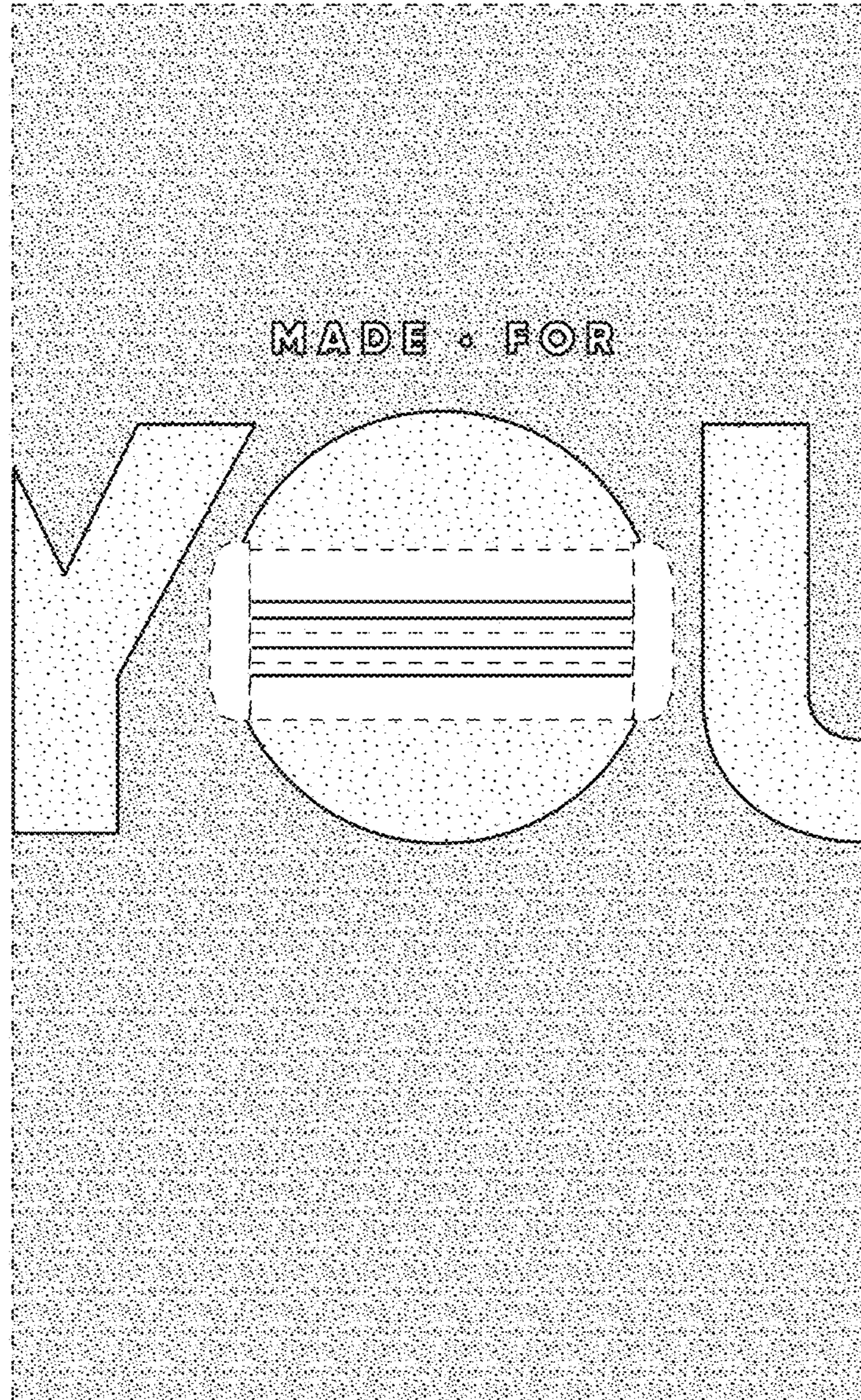

Fig. 11