



US00D902036S

(12) **United States Design Patent** (10) **Patent No.:** **US D902,036 S**
Wu (45) **Date of Patent:** **** Nov. 17, 2020**

(54) **FLIP-TOP CAP**
(71) Applicant: **Johnson & Johnson Surgical Vision, Inc.**, Santa Ana, CA (US)
(72) Inventor: **Robin Wu**, Osaka (JP)
(73) Assignee: **Johnson & Johnson Surgical Vision, Inc.**, Santa Ana, CA (US)
(**) Term: **15 Years**
(21) Appl. No.: **29/723,535**
(22) Filed: **Feb. 7, 2020**
(51) **LOC (12) Cl.** **09-07**
(52) **U.S. Cl.**
USPC **D9/449**
(58) **Field of Classification Search**
USPC D9/434, 435, 438-441, 443-454, 499, D9/503-505, 682, 685, 686; D7/300.1, D7/387, 391, 392, 392.1, 393, 394, 396.1, D7/396.2, 506, 507, 510, 511, 533, 534, D7/900; D3/202, 203.2, 294, 318; D28/91, 91.1
CPC .. A61J 1/00; A61J 1/1412; B65D 1/00; B65D 1/02; B65D 1/10; B65D 1/46; B65D 5/46; B65D 41/00; B65D 41/38; B65D 41/56; B65D 41/62; B65D 47/00; B65D 47/06; B65D 47/08; B65D 2251/00; B65D 2543/00046; B65D 2543/00092; B65D 2543/00296
See application file for complete search history.

D374,399 S * 10/1996 Neveras D9/447
D391,484 S 3/1998 Santagiuliana
5,967,384 A * 10/1999 Mengeu B65D 47/089
222/517
D438,799 S * 3/2001 Anderson D9/449
D450,585 S * 11/2001 Kamata D9/449
D451,392 S 12/2001 Kitamura
D455,077 S * 4/2002 Gaiser D9/449
(Continued)

OTHER PUBLICATIONS

Ebay Feb. 7, 2020 Lot—Bausch & Lomb ReNu Bottles: <https://www.ebay.com/i/323751929716?chn=1&mkevt=1&mkrid=711-117182-37290-0&mkcid=2&itemid=323751929716&targetid=856577>.

Primary Examiner — Wendy L Arminio

(57) **CLAIM**

The ornamental design for a flip-top cap, as shown and described.

DESCRIPTION

FIG. 1 is a front, right, top perspective view of a flip-top cap showing my new design;
FIG. 2 is a front elevational view of the flip-top cap shown in FIG. 1;
FIG. 3 is a right-side elevational view of the flip-top cap shown in FIG. 1;
FIG. 4 is a back elevational view of the flip-top cap shown in FIG. 1;
FIG. 5 is a left side elevational view of the flip-top cap shown in FIG. 1;
FIG. 6 is a top plan view of the flip-top cap shown in FIG. 1; and,
FIG. 7 is a bottom plan view of the flip-top cap shown in FIG. 1.
The dash-dot-dash broken lines depict environment and form no part of the claimed design. All other broken lines depict portions of the flip-top-cap that form no part of the claimed design.

1 Claim, 6 Drawing Sheets

(56) **References Cited**
U.S. PATENT DOCUMENTS
D298,014 S 10/1988 McGlyn
D306,265 S * 2/1990 Leebeek D9/435
D306,701 S 3/1990 Beck
D333,435 S 2/1993 Blair
D350,482 S 9/1994 Hu
D362,186 S 9/1995 Thanisch
D367,424 S 2/1996 Thanisch

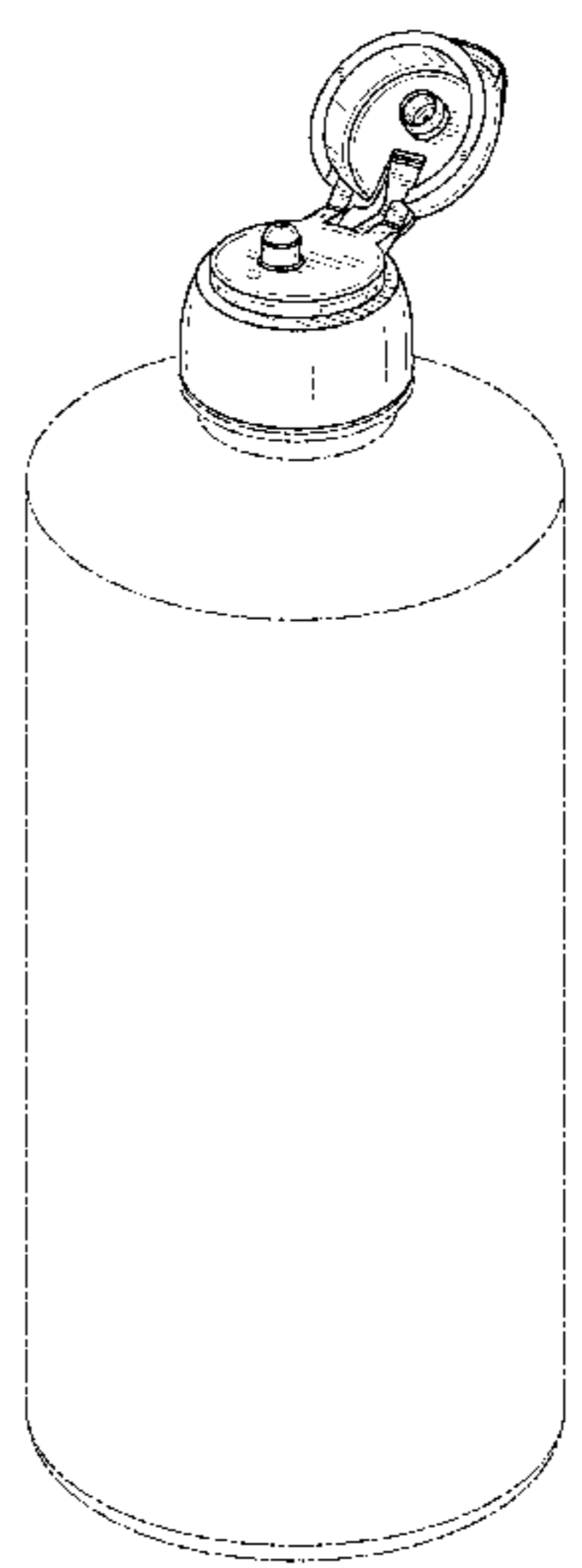

(56)

References Cited

U.S. PATENT DOCUMENTS

D504,818 S	5/2005	Bakic	
D508,853 S *	8/2005	Ziegenhorn	D9/449
D519,029 S	4/2006	Hicks	
D524,650 S	7/2006	Sitomer	
D537,342 S	2/2007	Smith	
D547,184 S	7/2007	Kim	
D608,198 S	1/2010	Lohrman	
D608,199 S	1/2010	Gross	
D610,454 S	2/2010	Lohrman	
D612,729 S	3/2010	Lohrman	
D626,411 S	11/2010	Lohrman	
D640,134 S	6/2011	Rognard	
D666,096 S *	8/2012	Cummings	D9/447
D666,098 S *	8/2012	Cummings	D9/447
D672,650 S	12/2012	Wisniewski	
D673,044 S	12/2012	Wisniewski	
D688,554 S *	8/2013	Fracasso	D9/447
D707,125 S	6/2014	Santarelli	
D709,764 S *	7/2014	Gibb	D9/449
D713,723 S *	9/2014	den Boer	D9/449
D768,490 S	10/2016	Robinson	
D780,579 S	3/2017	Kim	
D798,712 S	10/2017	Fukumoto	
D854,414 S	7/2019	Michailides	
D856,804 S	8/2019	Levy	
D857,502 S	8/2019	Fracasso	
D859,153 S	9/2019	Ramsuer	
D859,154 S	9/2019	Skillin	
D867,138 S	11/2019	Levy	
D867,139 S	11/2019	Levy	
2004/0016714 A1 *	1/2004	Wood	B65D 47/0828 215/235

* cited by examiner

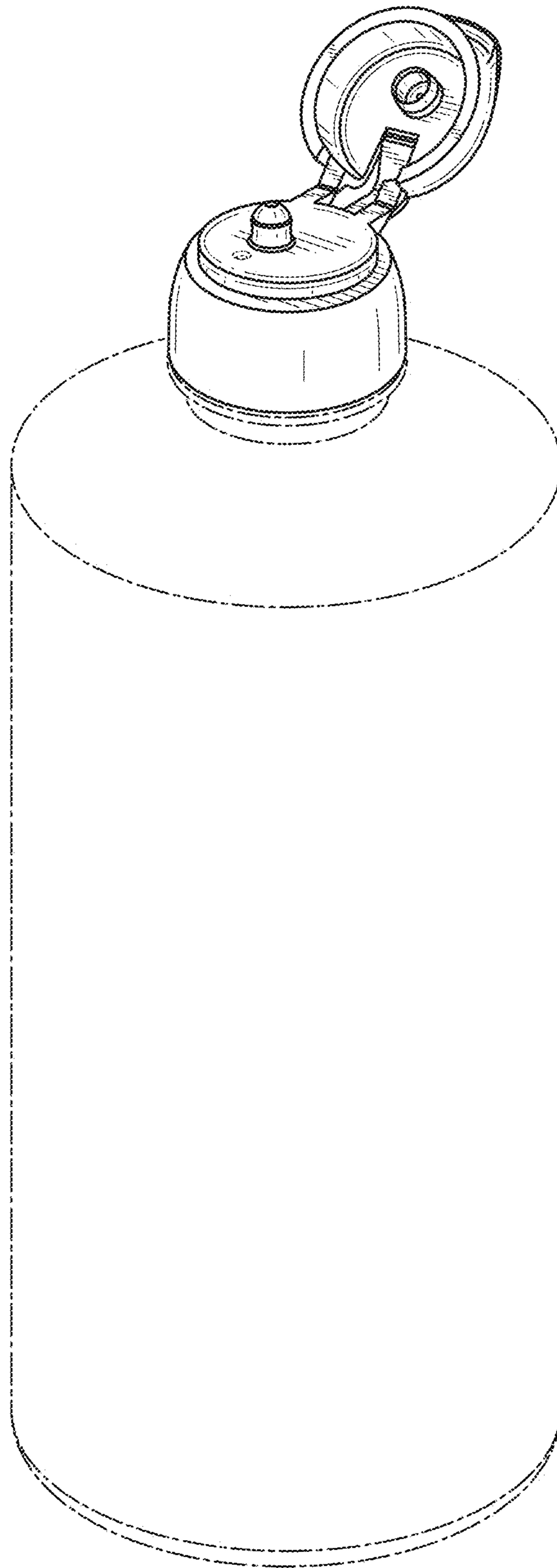

FIG. 1

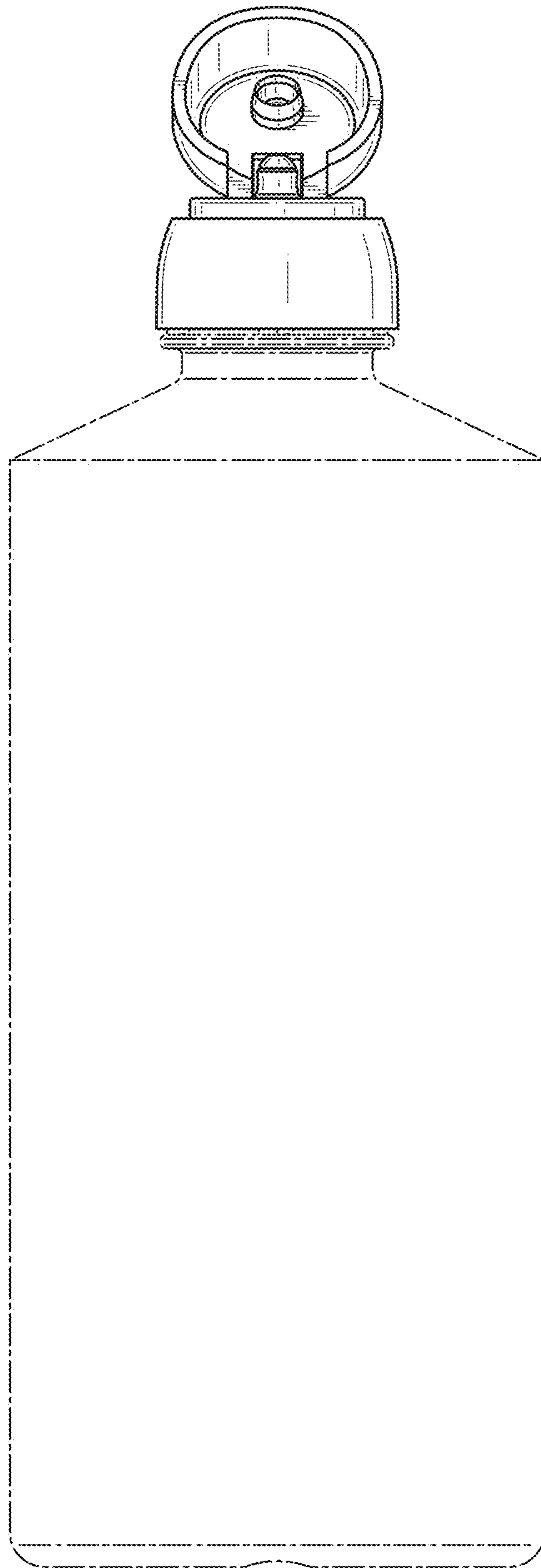

FIG. 2

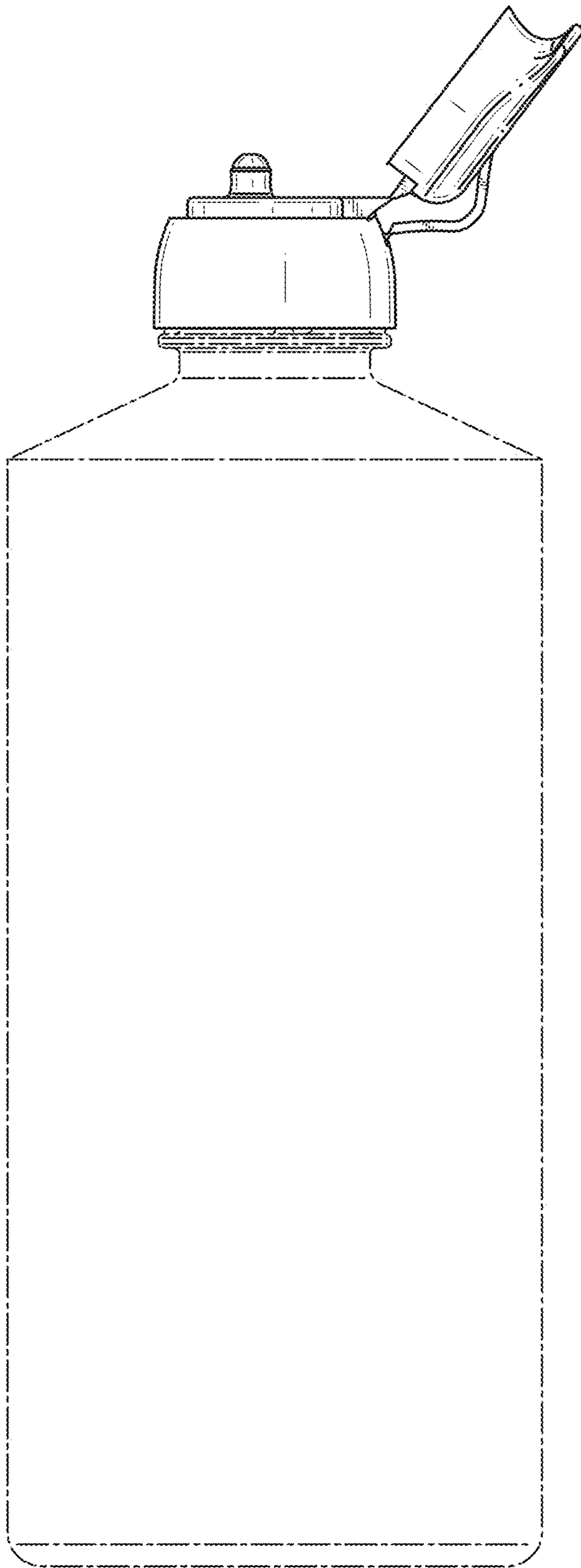

FIG. 3

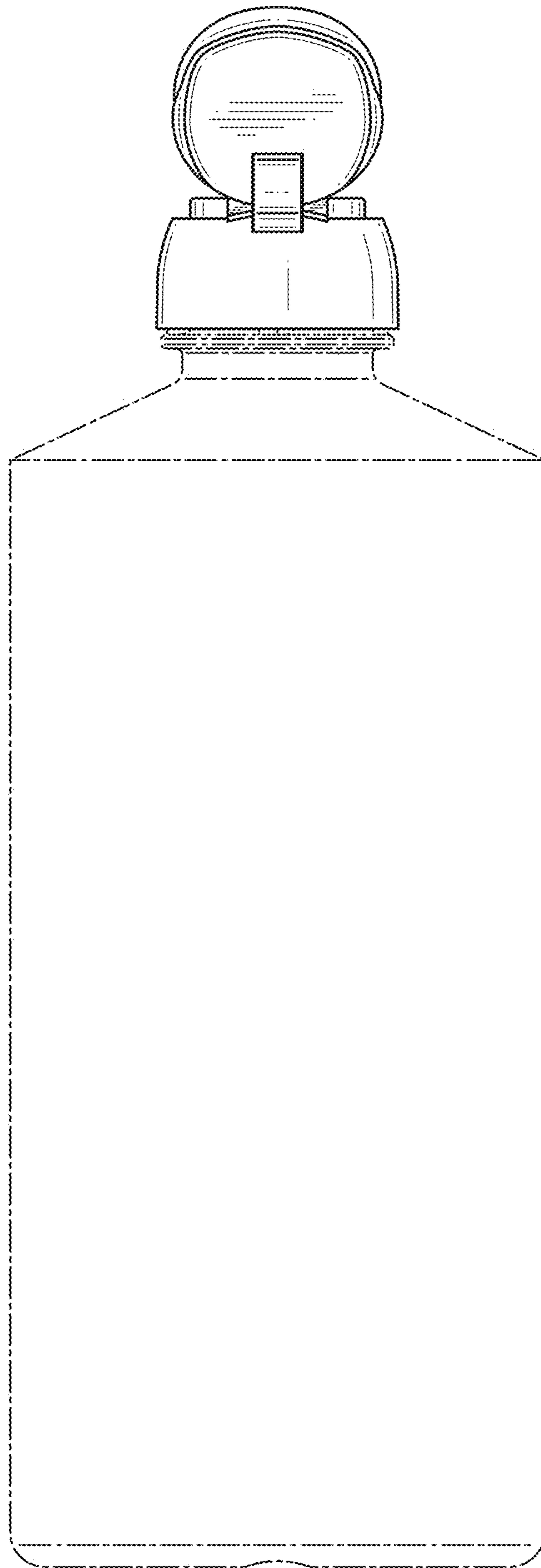

FIG. 4

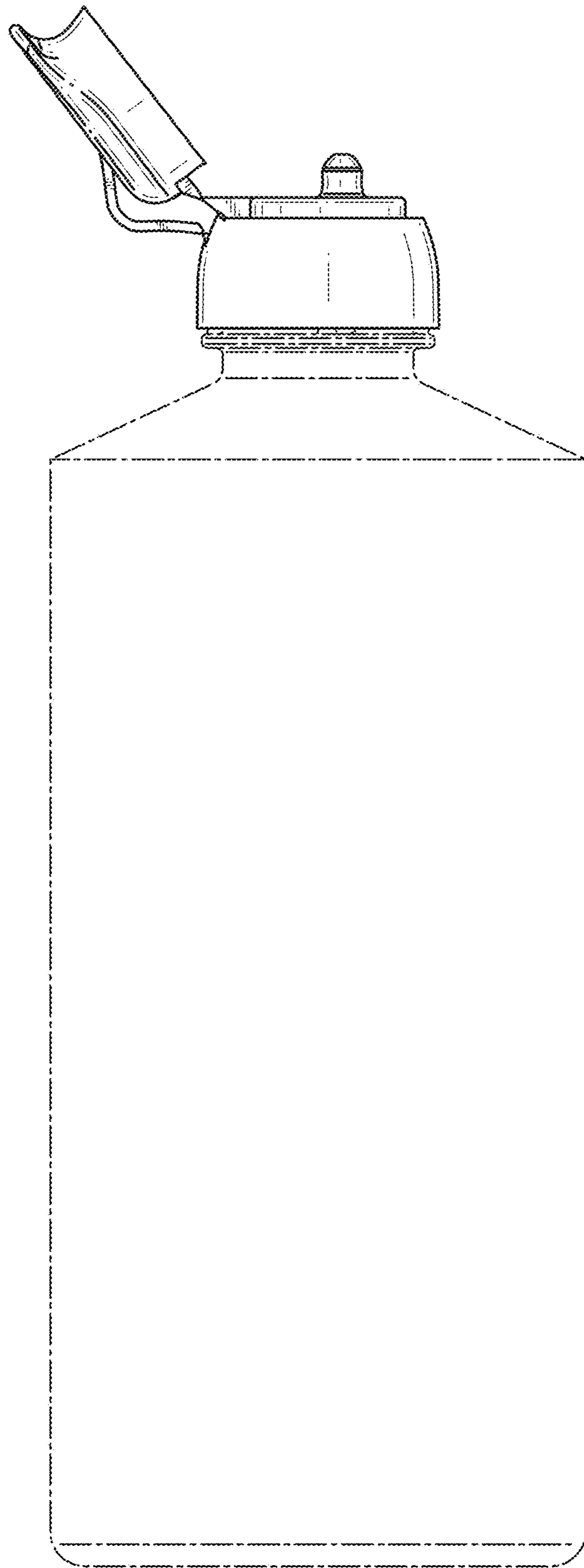

FIG. 5

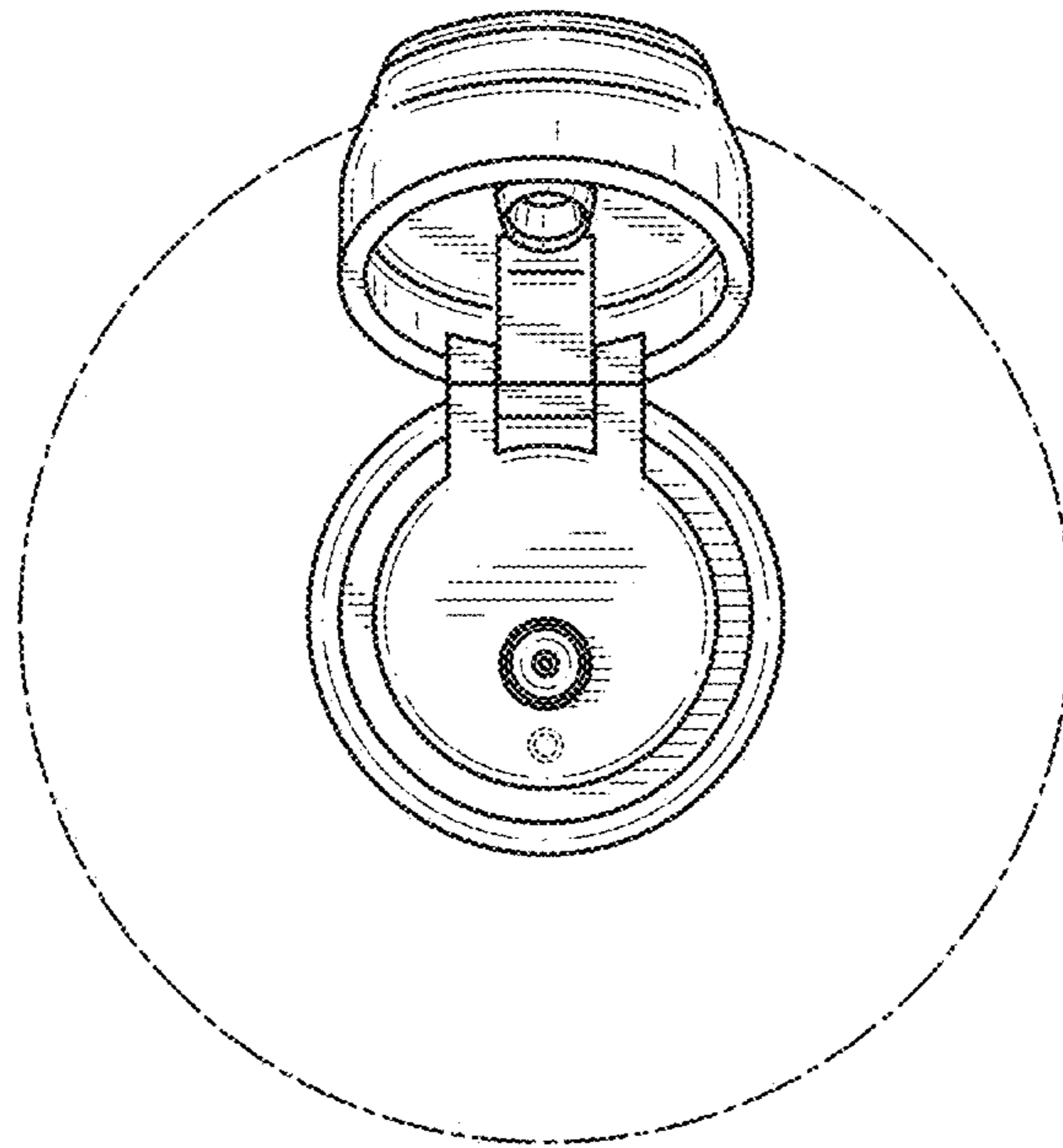

FIG. 6

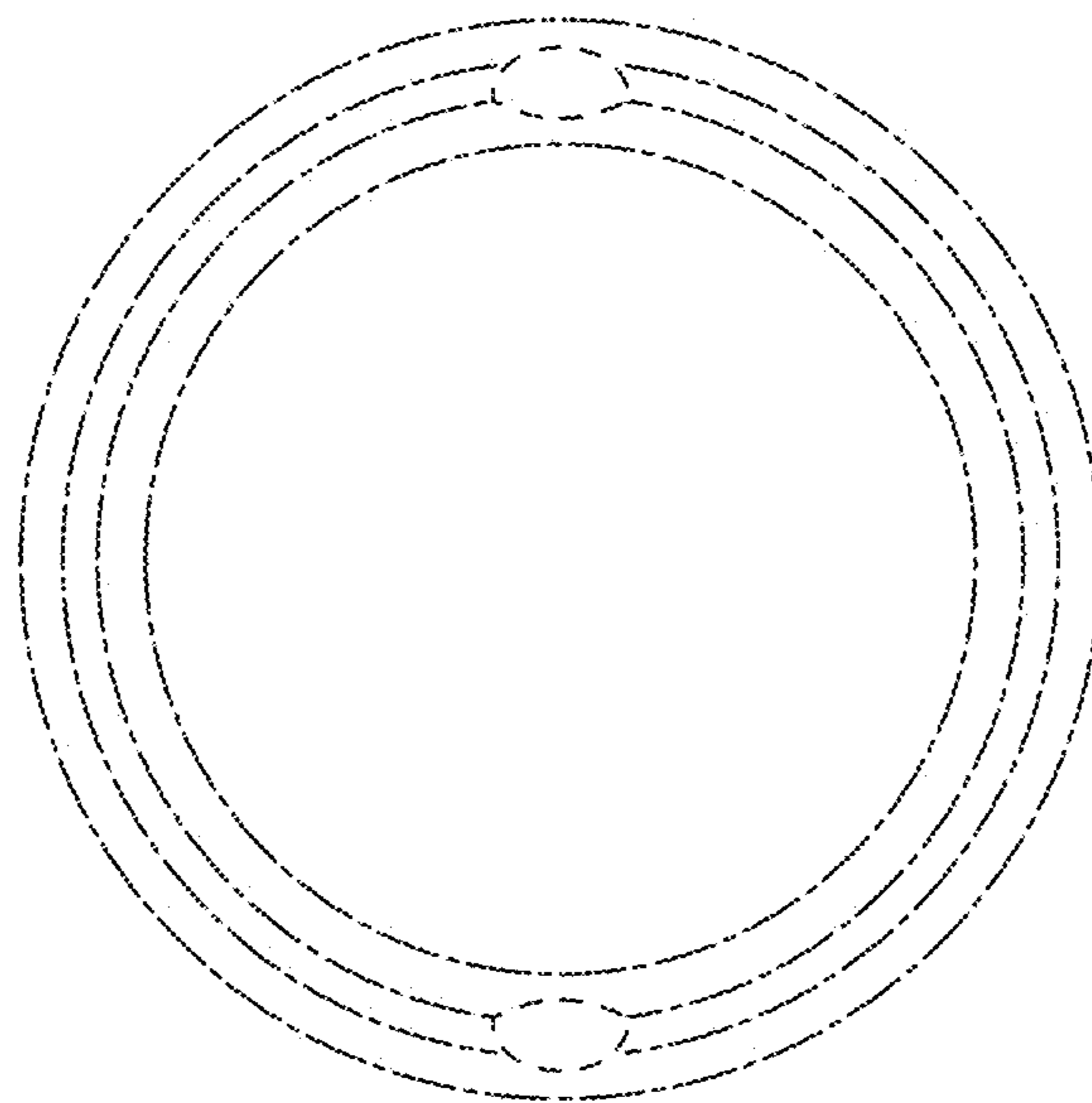

FIG. 7