



US00D902035S

(12) **United States Design Patent** (10) **Patent No.:** **US D902,035 S**
Kim (45) **Date of Patent:** **** Nov. 17, 2020**

(54) **CONTAINER FOR COSMETICS**
(71) Applicant: **YONWOO CO., LTD.**, Incheon (KR)
(72) Inventor: **Hyun Jeong Kim**, Incheon (KR)
(73) Assignee: **YONWOO CO., LTD.**, Incheon (KR)
(**) Term: **15 Years**
(21) Appl. No.: **29/702,315**
(22) Filed: **Aug. 19, 2019**
(30) **Foreign Application Priority Data**

Mar. 14, 2019 (KR) 30-2019-0011560

(51) **LOC (12) Cl.** **09-07**

(52) **U.S. Cl.**
USPC **D9/447; D9/442; D9/695; D9/723**

(58) **Field of Classification Search**
USPC D9/414, 424, 425, 428, 432, 434, 435,
D9/436, 439, 440, 443-450, 452-457,
D9/499, 503, 682, 685, 686, 695, 697,
D9/723, 724; D7/387, 391, 392, 392.1,
D7/396.2, 510, 511, 538, 900; D3/202,
D3/203.2; D28/91, 91.1, 7
CPC .. A61J 1/00; A61J 1/1412; B65D 1/00; B65D
1/02; B65D 1/10; B65D 1/46; B65D
5/46; B65D 41/00; B65D 41/38; B65D
41/56; B65D 41/62; B65D 47/00; B65D
47/06; B65D 47/08; B65D 2251/00;
B65D 2543/00046; B65D 2543/00092;
B65D 2543/00296

See application file for complete search history.

(56) **References Cited**

U.S. PATENT DOCUMENTS

D92,135 S * 5/1934 Johnson D9/697
2,021,653 A * 11/1935 Johnson B65D 35/38
401/266

D221,628 S * 8/1971 Boulanger D9/444
3,809,299 A * 5/1974 Sand B65D 47/242
D9/450
D232,421 S * 8/1974 Edwards D9/428
D233,314 S * 10/1974 Turner et al. D9/697
D236,089 S * 7/1975 Edwards D9/428
D383,672 S * 9/1997 Mangos D9/444
D414,688 S * 10/1999 Loeb D9/697
D423,355 S * 4/2000 Loeb D9/447
D447,949 S * 9/2001 Richardson D9/435
D626,428 S * 11/2010 Fallat, II D9/695
D668,963 S * 10/2012 Py D9/695
D731,322 S * 6/2015 Seo D9/697
9,681,728 B2 * 6/2017 Jung B65D 35/36
D795,066 S * 8/2017 Son D9/442
9,732,376 B2 * 8/2017 Oyler A61B 10/0051
9,848,684 B2 * 12/2017 Kim A45D 40/26
9,867,443 B2 * 1/2018 Kim A45D 40/26
D831,484 S * 10/2018 Jung D9/723

(Continued)

Primary Examiner — Wendy L Arminio
(74) *Attorney, Agent, or Firm* — Novick, Kim & Lee,
PLLC; Sang Ho Lee; Hyun Woo Shin

(57) **CLAIM**

I claim the ornamental design for a container for cosmetics,
as shown and described.

DESCRIPTION

FIG. 1 is a perspective view of a container for cosmetics,
showing my new design;
FIG. 2 is a front elevational view thereof;
FIG. 3 is a rear elevational view thereof;
FIG. 4 is a left side elevational view thereof;
FIG. 5 is a right side elevational view thereof;
FIG. 6 is a top plan view thereof; and,
FIG. 7 is a bottom plan view thereof.
The broken lines in the drawings show portions of the
container for cosmetics which form no part of the claimed
design.

1 Claim, 6 Drawing Sheets

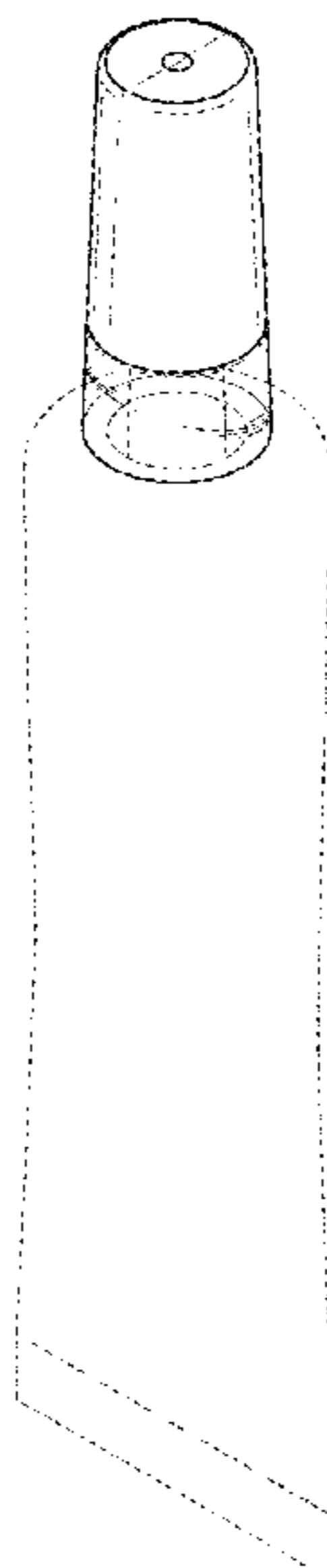

(56)

References Cited

U.S. PATENT DOCUMENTS

D834,427	S	*	11/2018	Kim	D9/724
D840,830	S	*	2/2019	Son	D9/697
D855,892	S	*	8/2019	Lee	D28/88
D888,552	S	*	6/2020	Tempfli	D9/435
2009/0133711	A1	*	5/2009	Pires	A45D 33/00
						132/293
2016/0272381	A1	*	9/2016	Kim	A45D 34/00

* cited by examiner

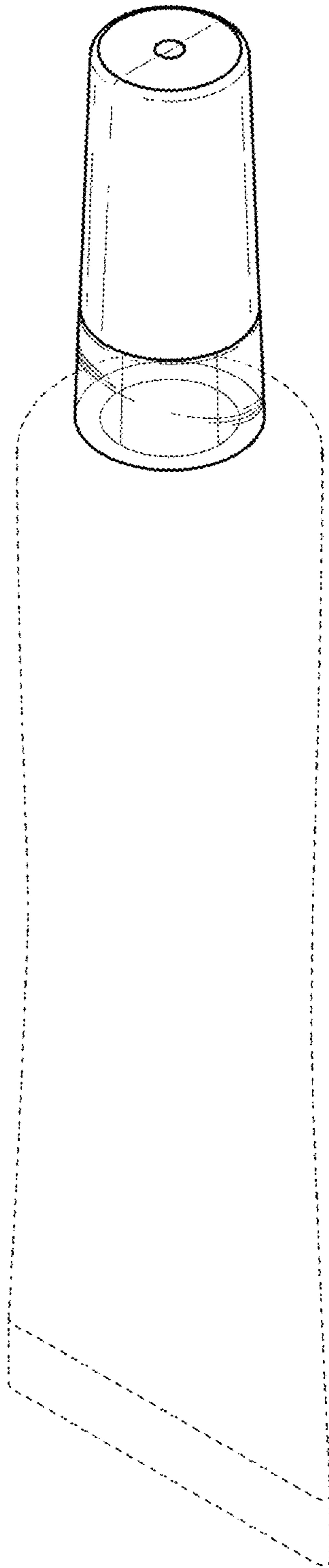

FIG. 1

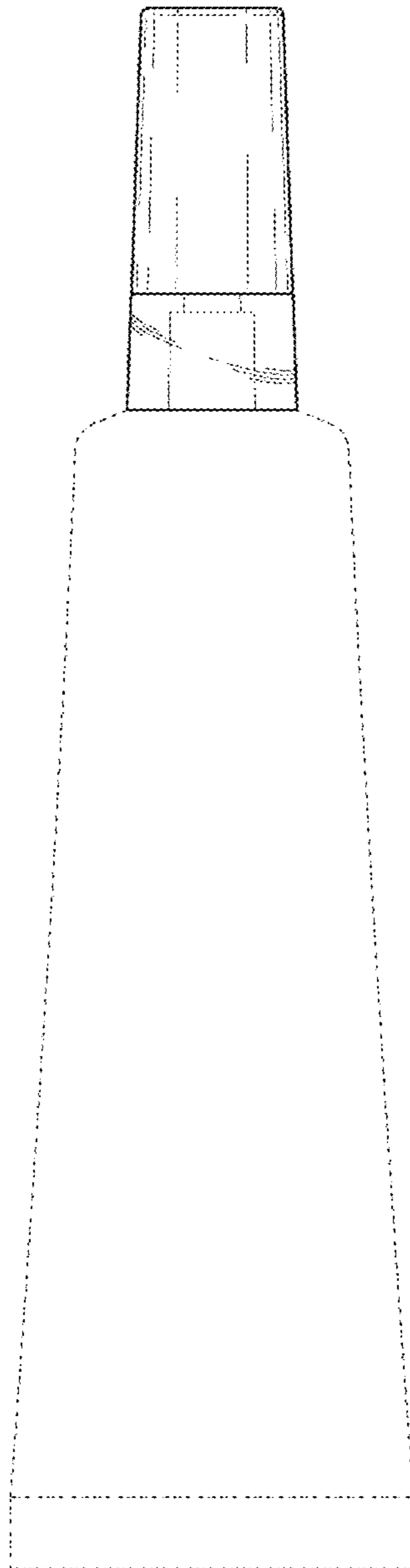

FIG. 2

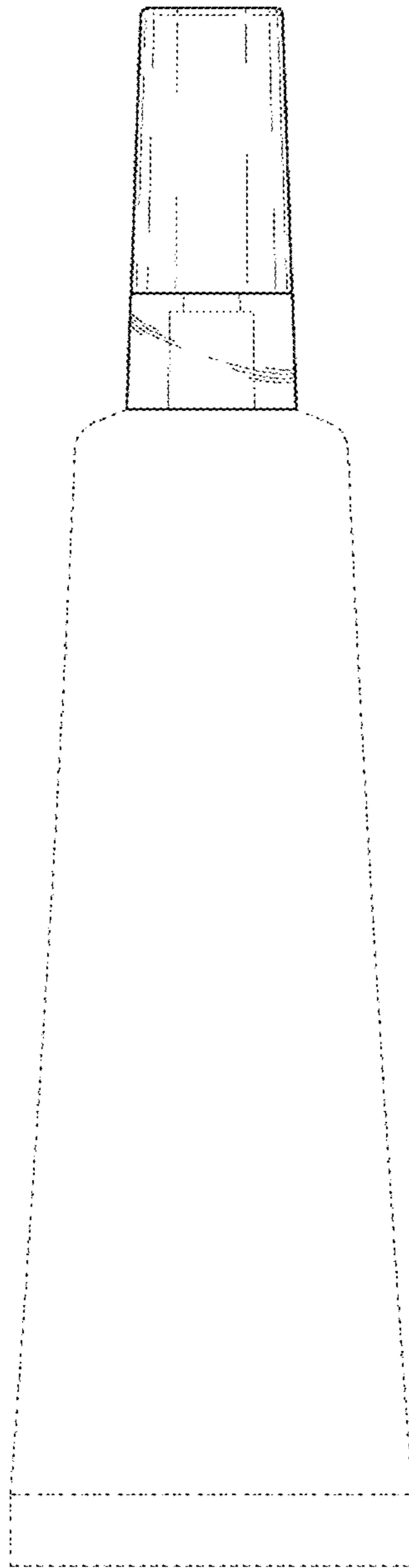

FIG. 3

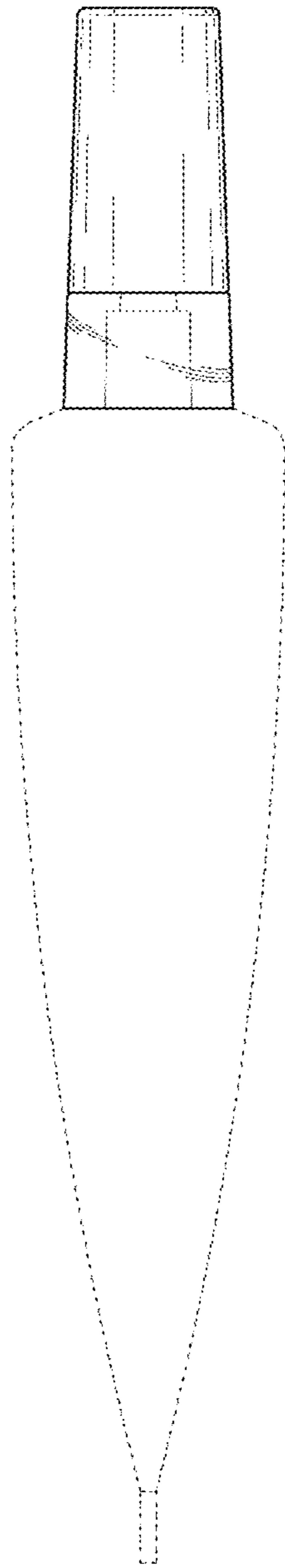

FIG. 4

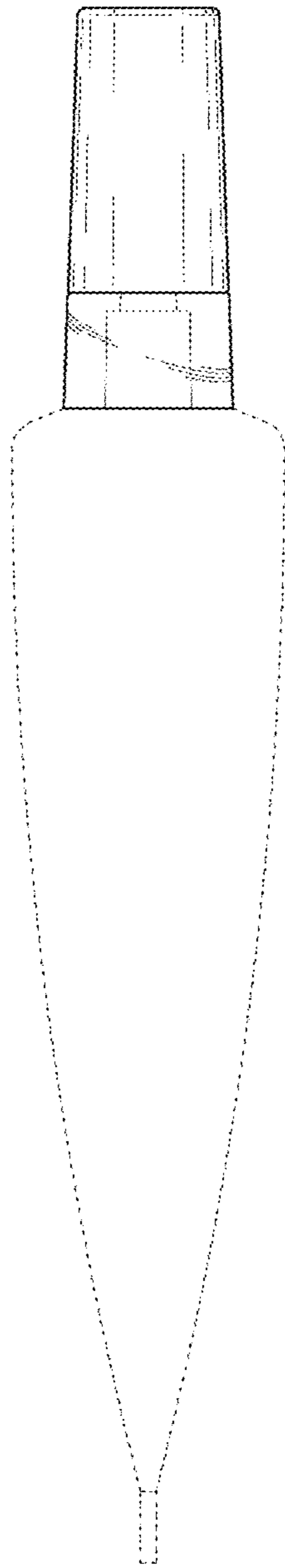

FIG. 5

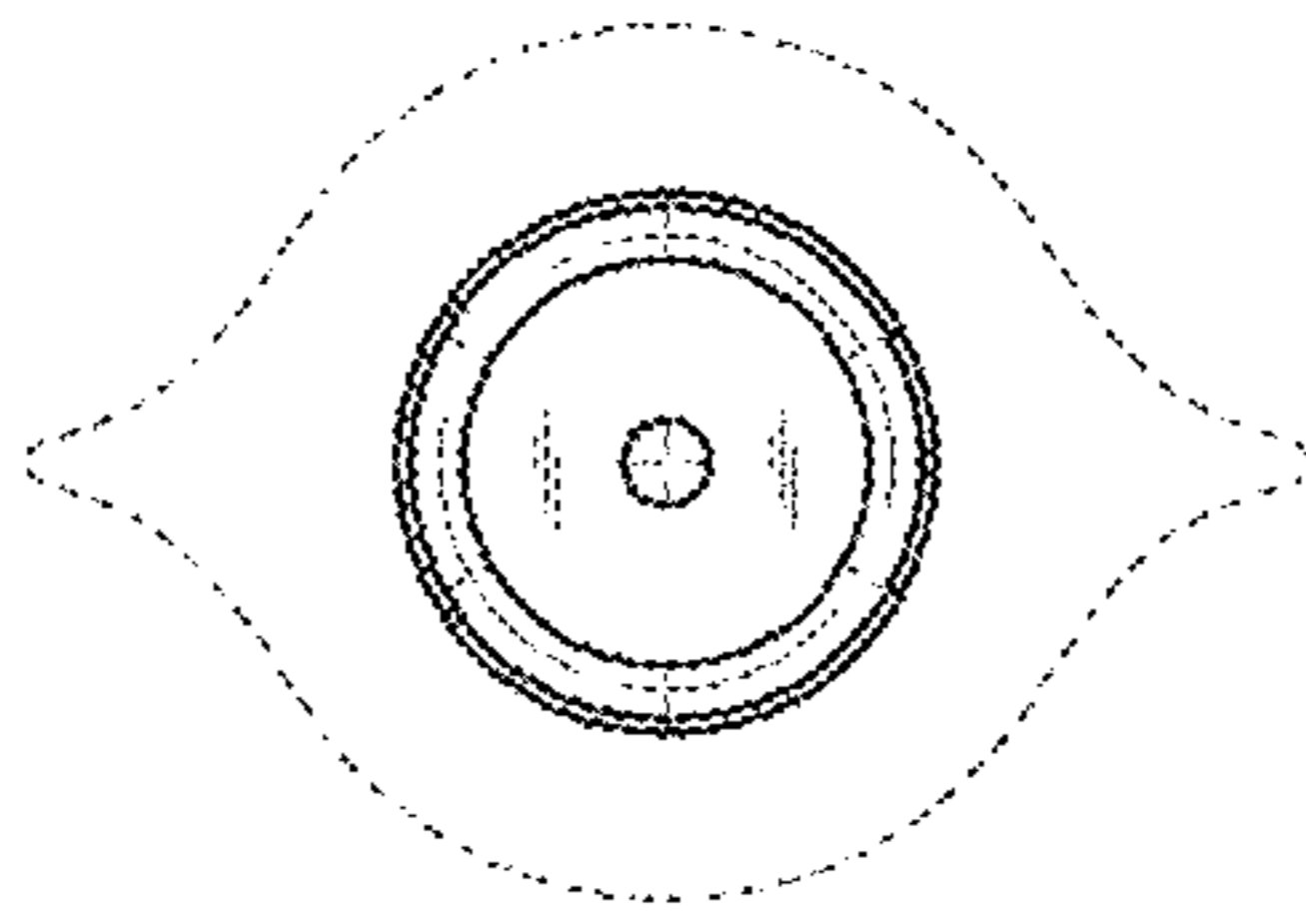

FIG. 6

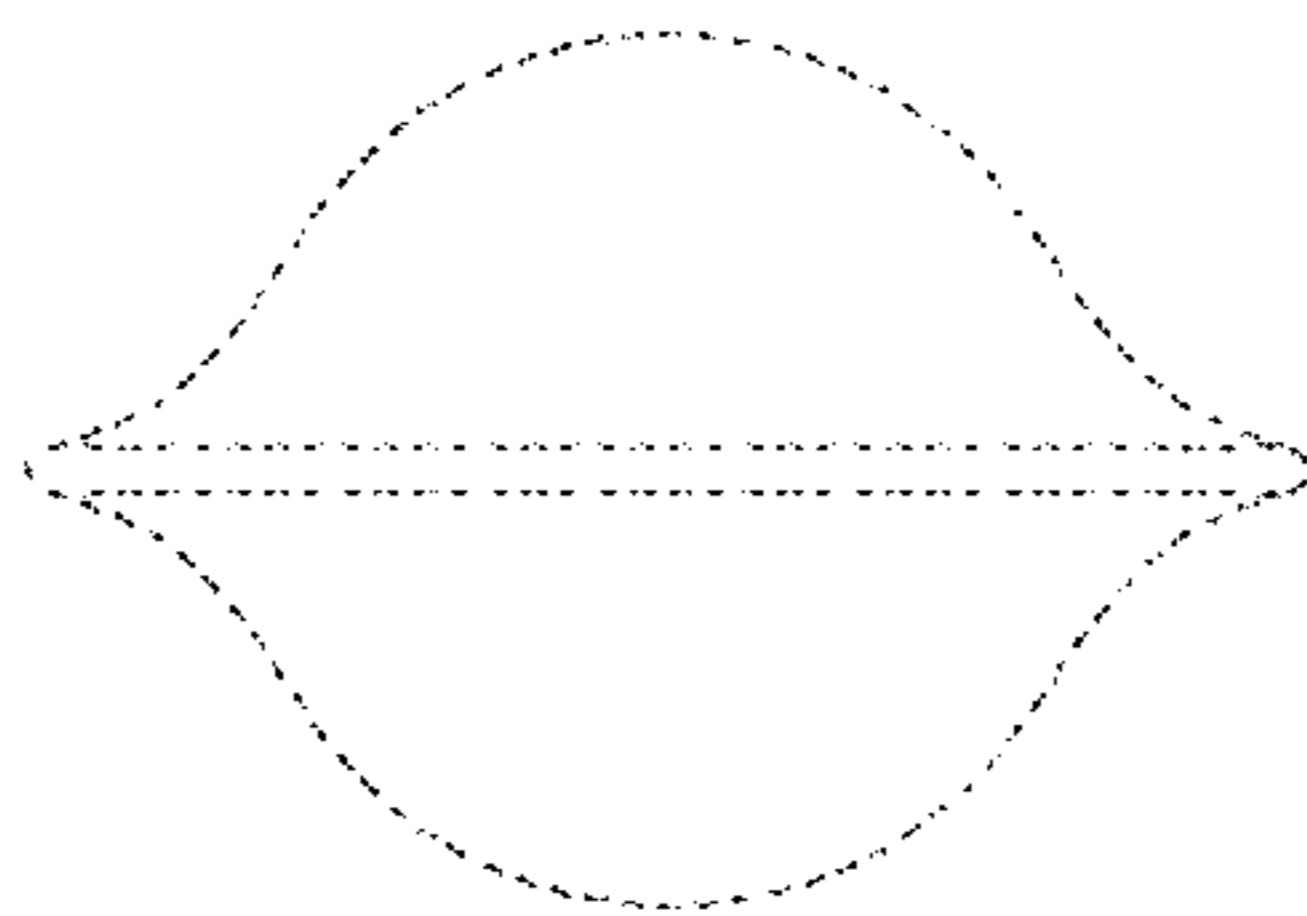

FIG. 7