



US00D901873S

(12) **United States Design Patent** (10) **Patent No.:** **US D901,873 S**
Hughes (45) **Date of Patent:** **** Nov. 17, 2020**

(54) **SHOOTING BAG**

(71) Applicant: **S/C Motorsports & Classics, Inc.,**
Mustang, OK (US)
(72) Inventor: **Mitchell Hughes,** Mustang, OK (US)
(73) Assignee: **S/C Motorsports & Classics, Inc.,**
Mustang, OK (US)
(**) Term: **15 Years**

(21) Appl. No.: **29/658,956**
(22) Filed: **Aug. 3, 2018**
(51) **LOC (12) Cl.** **03-01**
(52) **U.S. Cl.**
USPC **D3/201**
(58) **Field of Classification Search**
USPC D22/108-111, 199; D3/201, 221, 231,
D3/254, 262, 315
CPC F41A 23/02; F41A 23/10; F41A 23/18;
F41A 23/16; F41A 17/44
See application file for complete search history.

(56) **References Cited**

U.S. PATENT DOCUMENTS

3,935,657	A *	2/1976	Wade	F41A 23/00
					42/94
D312,650	S *	12/1990	Charrier	248/346.2
5,233,779	A *	8/1993	Shaw	F41A 23/02
					42/94
5,332,185	A *	7/1994	Walker, III	F41A 23/02
					248/346.2
5,333,829	A *	8/1994	Bell	F16M 13/00
					211/64
5,875,580	A *	3/1999	Hill	F41A 23/02
					42/94
D447,531	S *	9/2001	Fiscus	D22/108
6,378,235	B1 *	4/2002	Smith	F41A 23/02
					42/94
9,964,254	B1 *	5/2018	Hayes	F41A 23/16

(Continued)

OTHER PUBLICATIONS

Google search of shooting bags; Jun. 11, 2019; <http://www.google.com/shooting+bags>.*

(Continued)

Primary Examiner — Mitchell I. Siegel
(74) *Attorney, Agent, or Firm* — Hall Estill Attorneys at Law; Mitchell K. McCarthy

(57) **CLAIM**

The ornamental design for a shooting bag, as shown and described.

DESCRIPTION

FIG. 1 is an isometric view of my ornamental design for a shooting bag.
FIG. 2 is a front elevational view thereof.
FIG. 3 is a side elevational view thereof.
FIG. 4 is a rear elevational view thereof.
FIG. 5 is a side elevational view thereof.
FIG. 6 is a top plan view thereof.
FIG. 7 is a bottom plan view thereof.
FIG. 8 is a front elevational view shown with the straps in an alternate position.
FIG. 9 is a top plan view of FIG. 8.
FIG. 10 is a side elevational view of FIG. 8.
FIG. 11 is a reduced front elevational view shown with the straps in another alternate position; the unclaimed rifle shown as environmental structure.
FIG. 12 is a reduced side elevational view shown with the straps in another alternate position; and,
FIG. 13 is a reduced side elevational view shown with the straps in another alternate position.
The broken lines in these drawings serve to illustrate the environment in which the claimed design is associated or serve to define the bounds of the claimed design. The broken lines form no part of the claimed design.

1 Claim, 13 Drawing Sheets

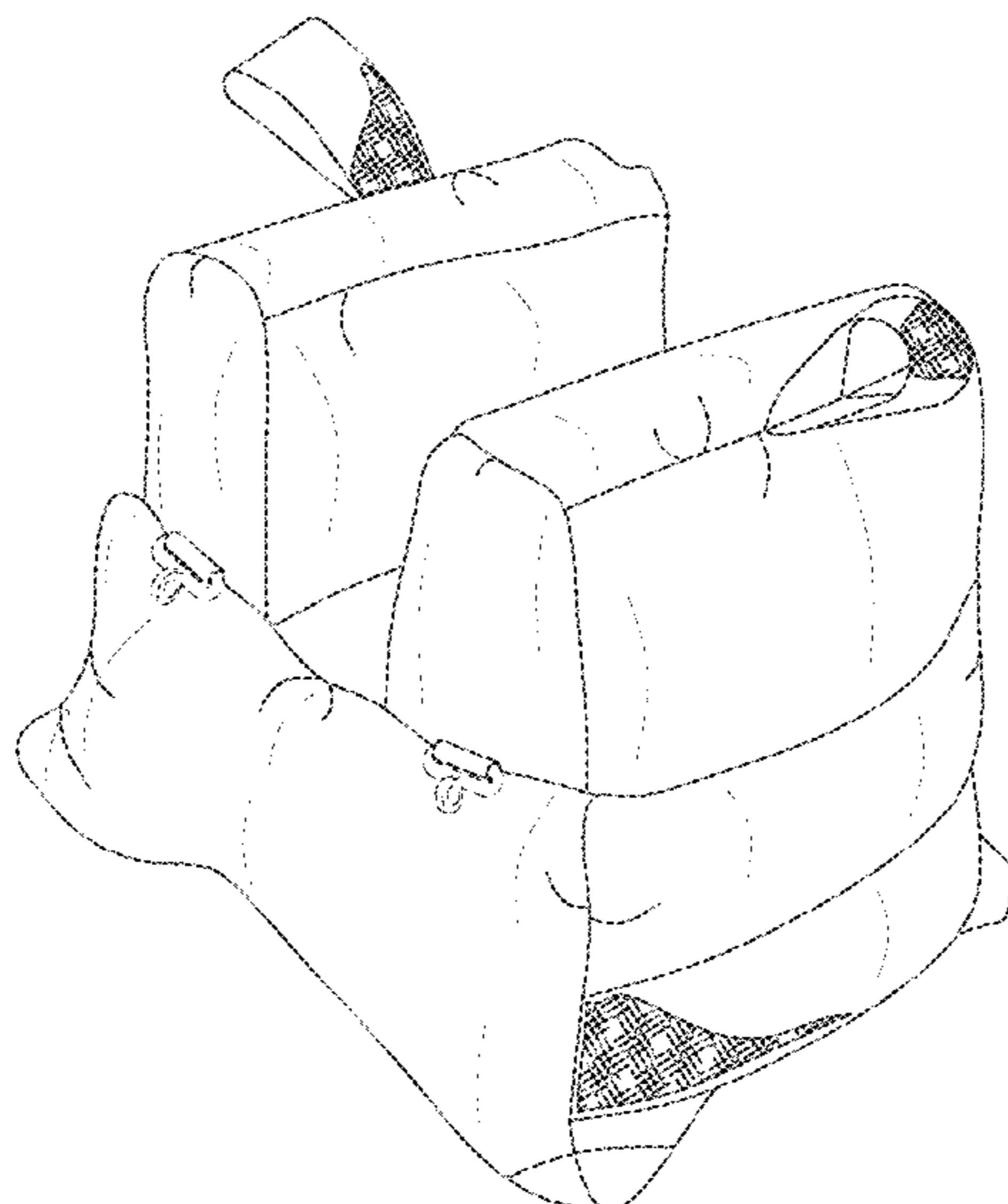

(56)

References Cited

U.S. PATENT DOCUMENTS

10,048,034 B1 * 8/2018 Reasor F41A 23/16
D837,923 S * 1/2019 Gleick D22/108
2008/0034636 A1 * 2/2008 Potterfield F41A 23/04
42/94
2015/0292830 A1 * 10/2015 Treadaway F41A 23/04
42/94

OTHER PUBLICATIONS

Amazon search of shooting bags; Jun. 11, 2019; https://www.amazon.com/s?k=shooting+bag&i=sporting&crd=3RFB5YZNYNGK5&sprefix=shoot%2Csporting%2C124&ref=nb_sb_ss_i_8_5.*

* cited by examiner

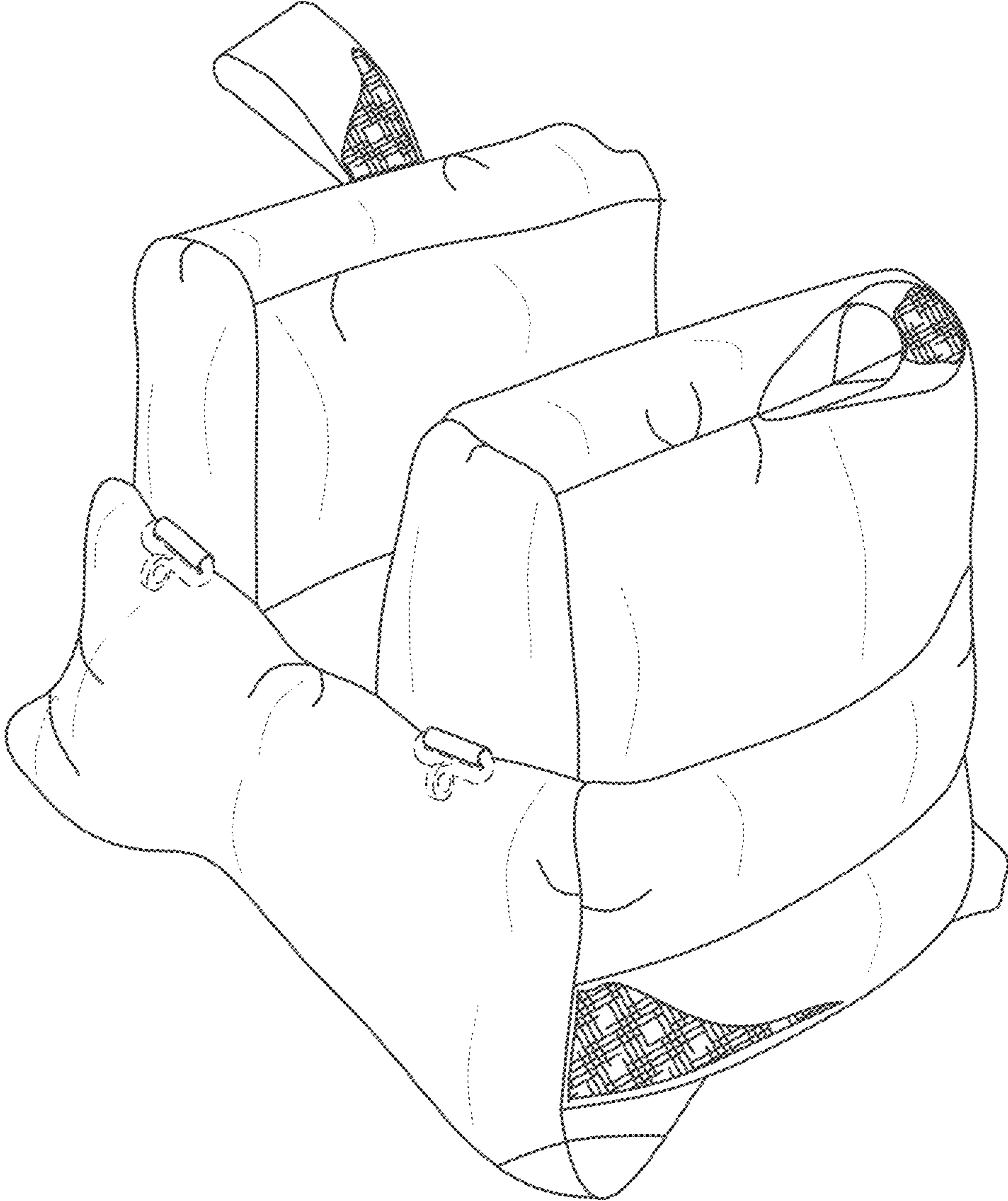

FIG. 1

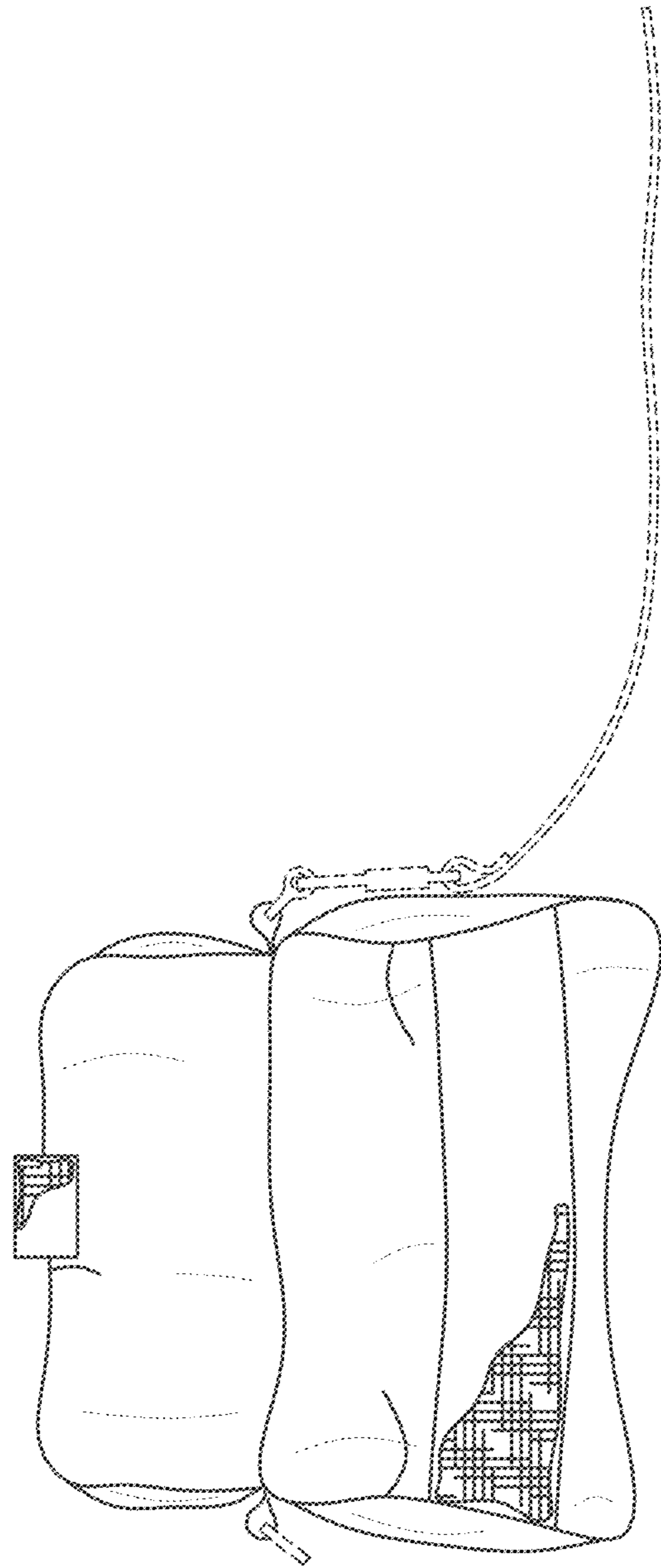

FIG. 2

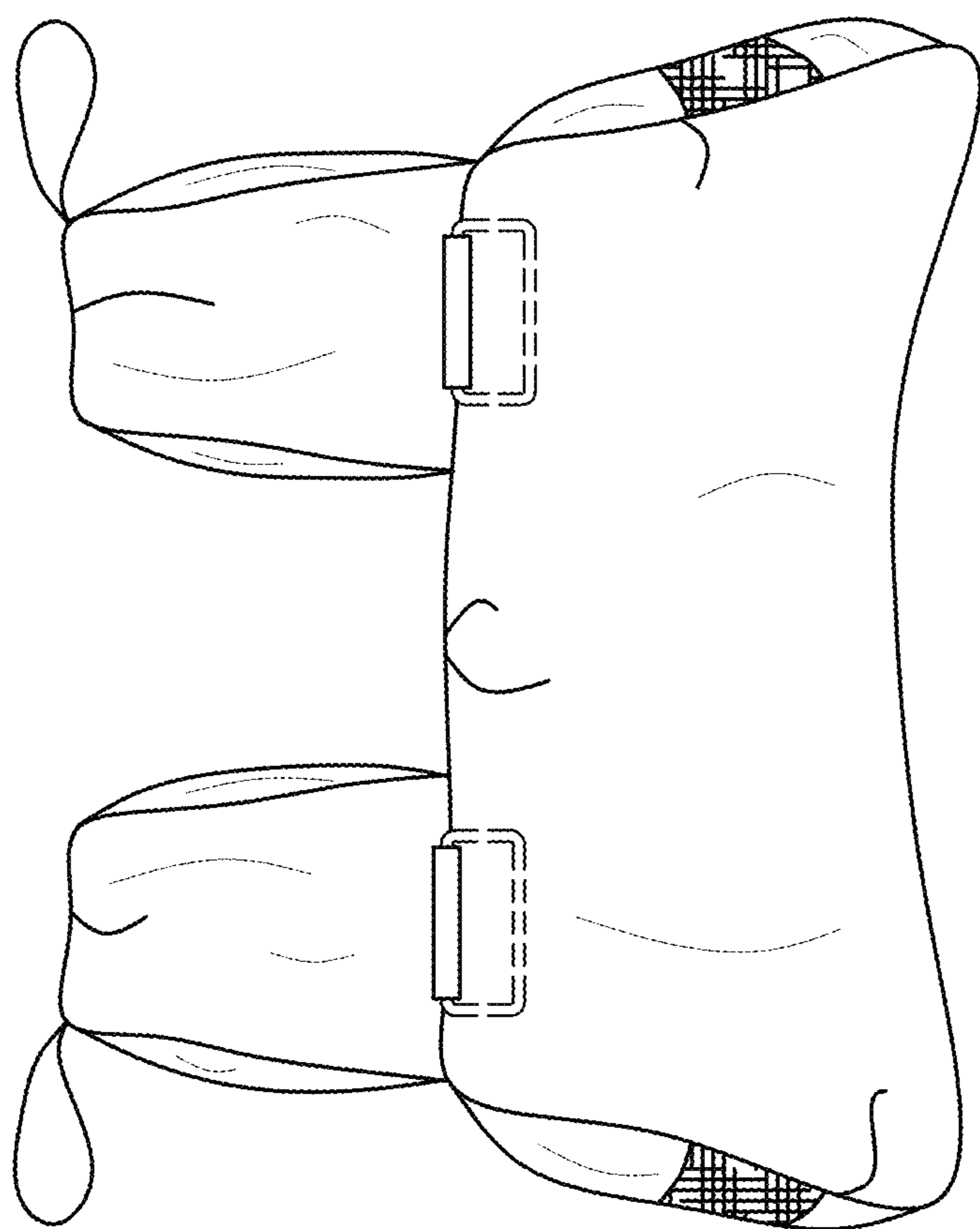

FIG. 3

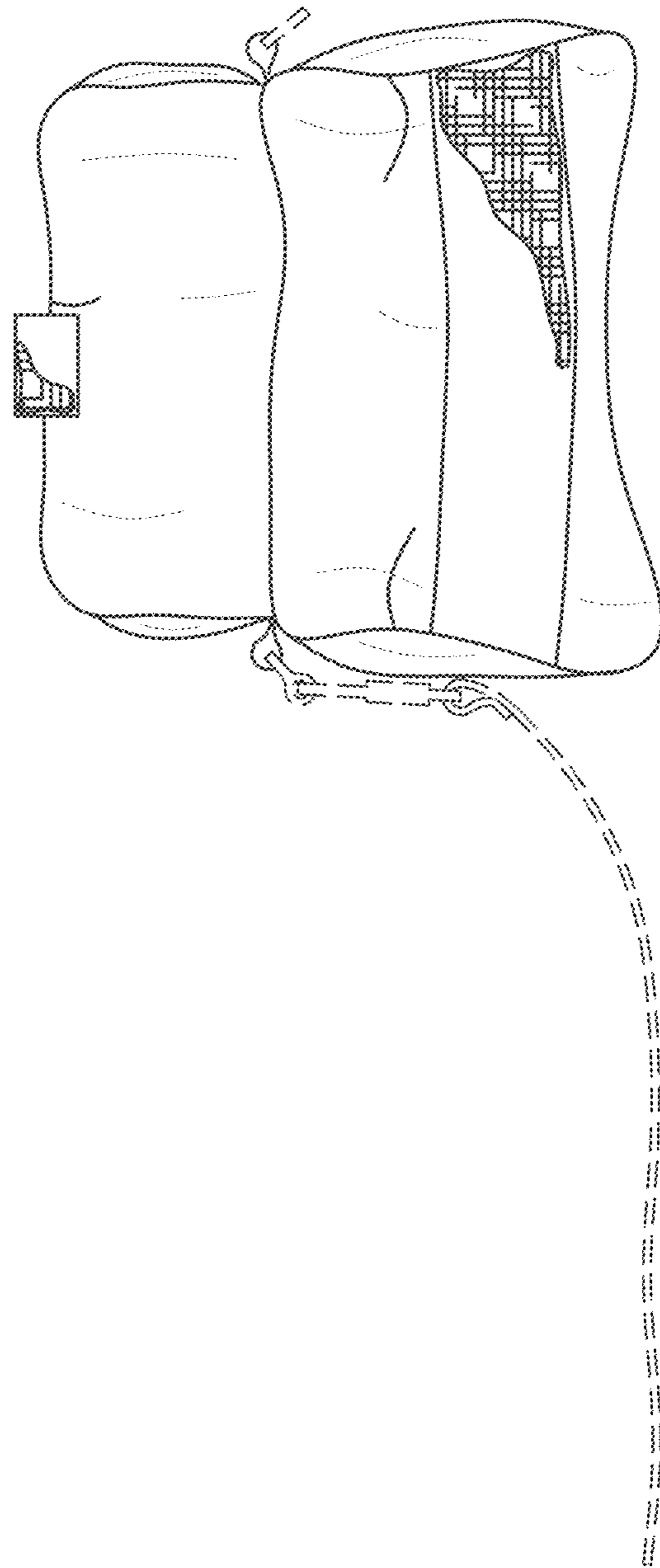

FIG. 4

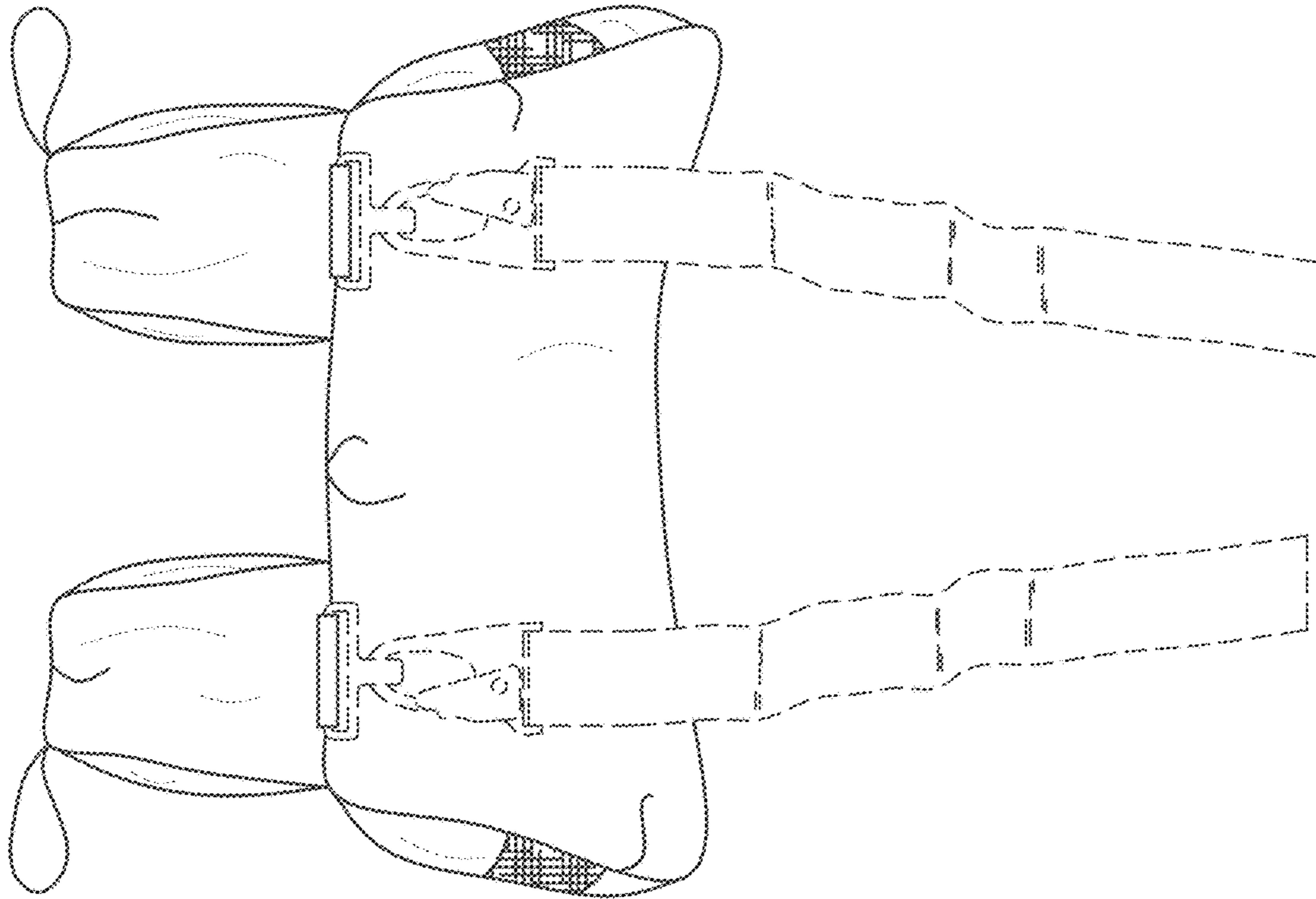

FIG. 5

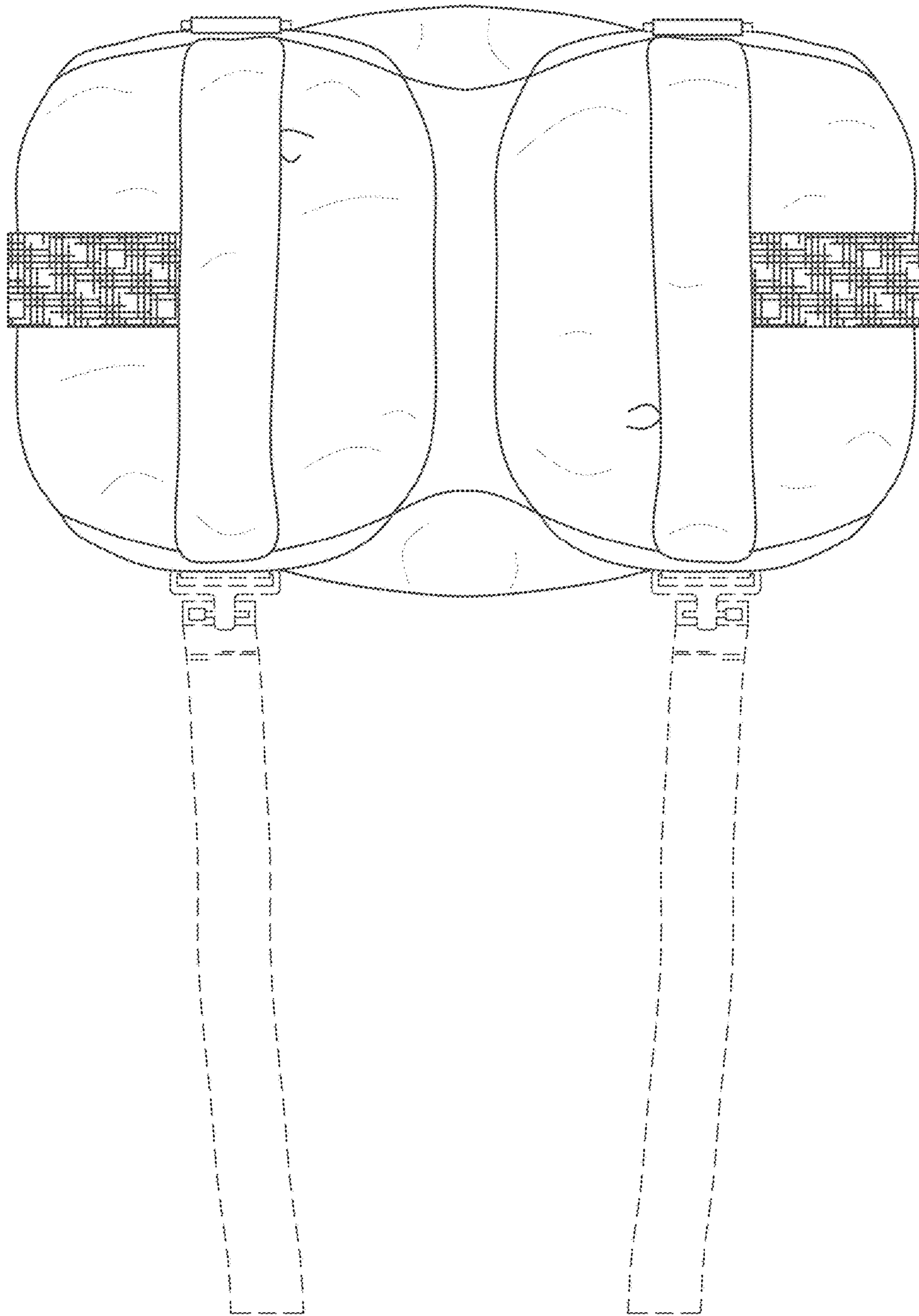

FIG. 6

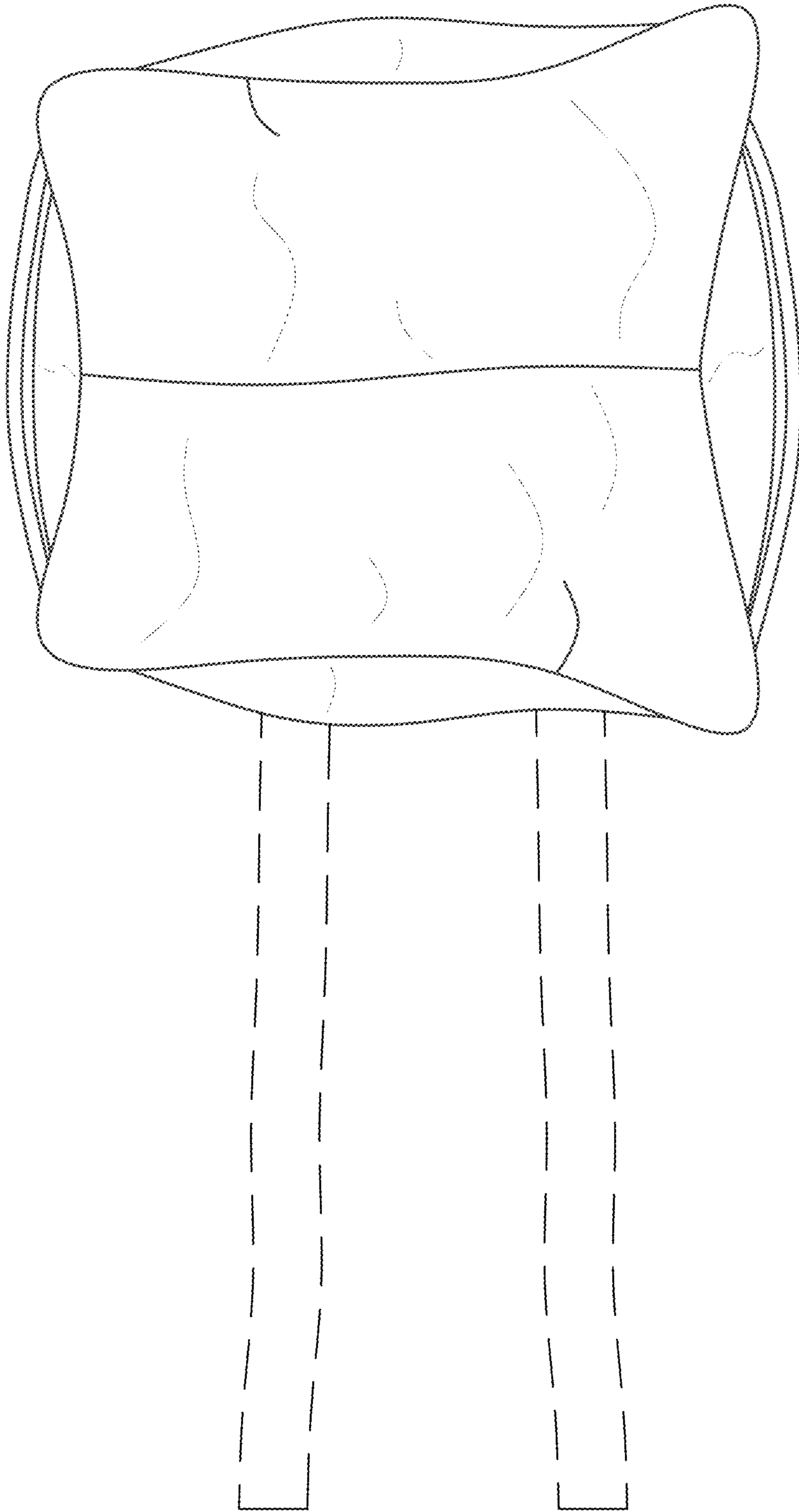

FIG. 7

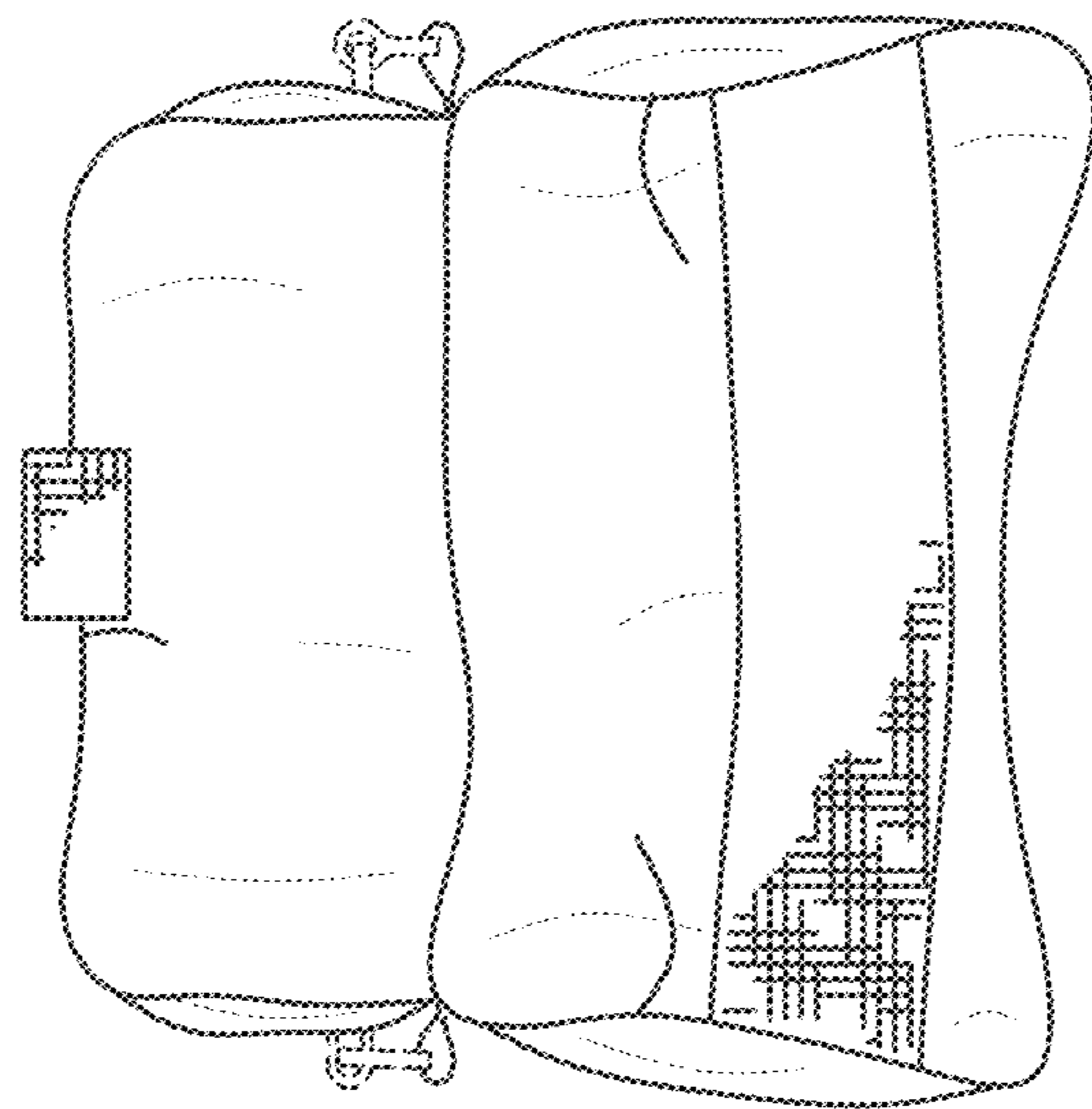

FIG. 8

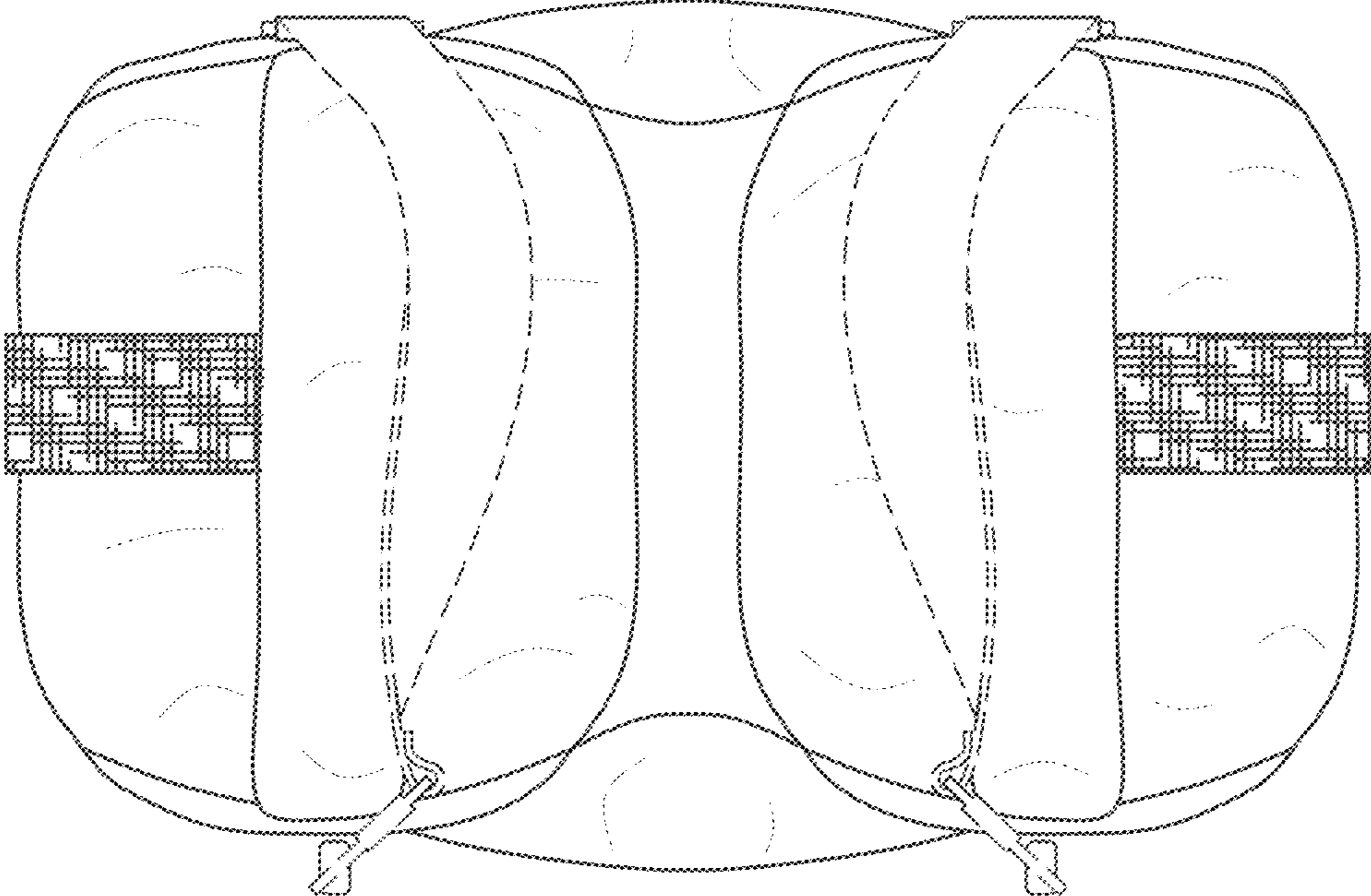

FIG. 9

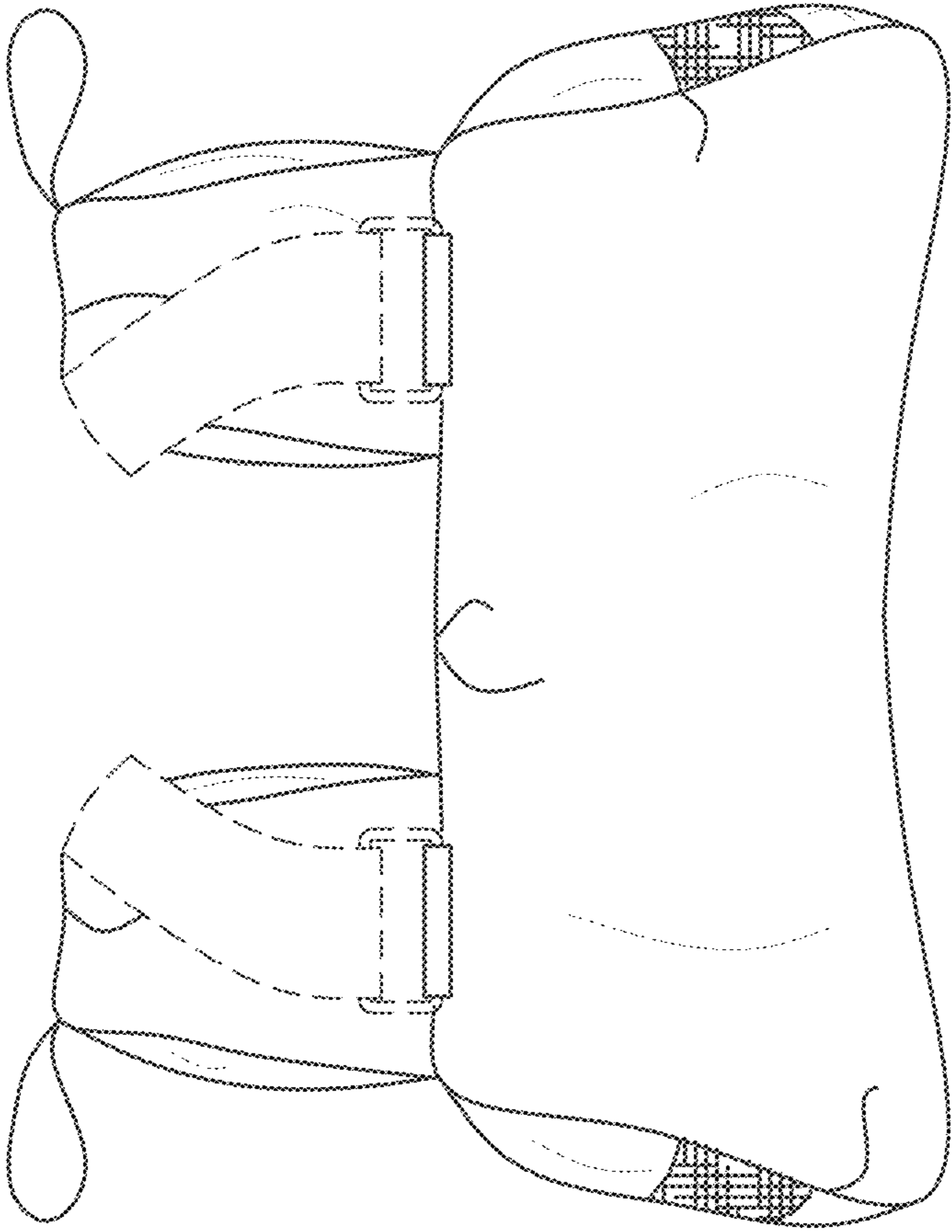

FIG. 10

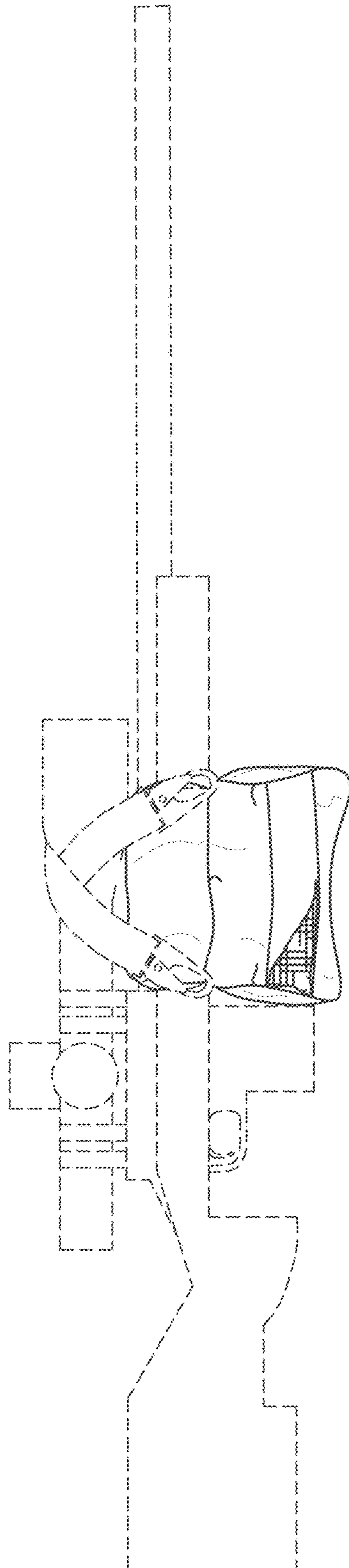

FIG. 11

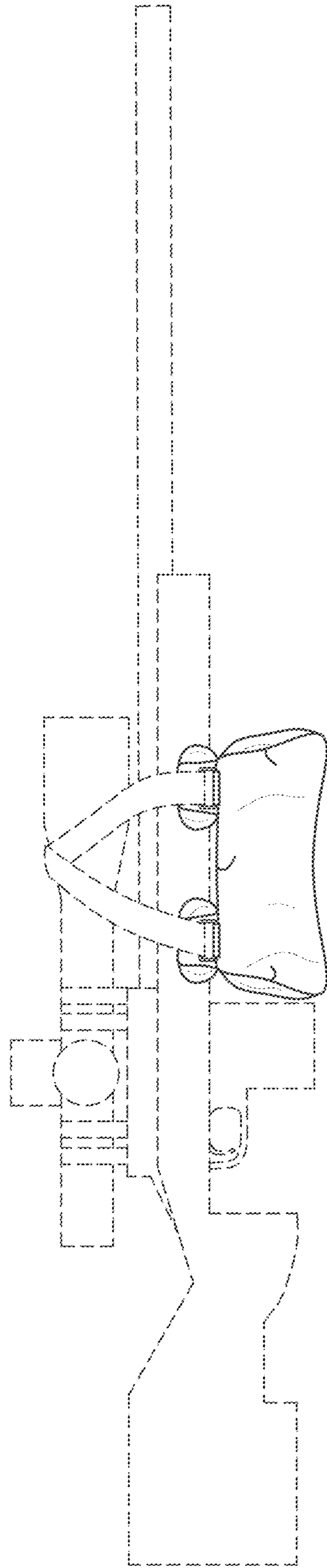

FIG. 12

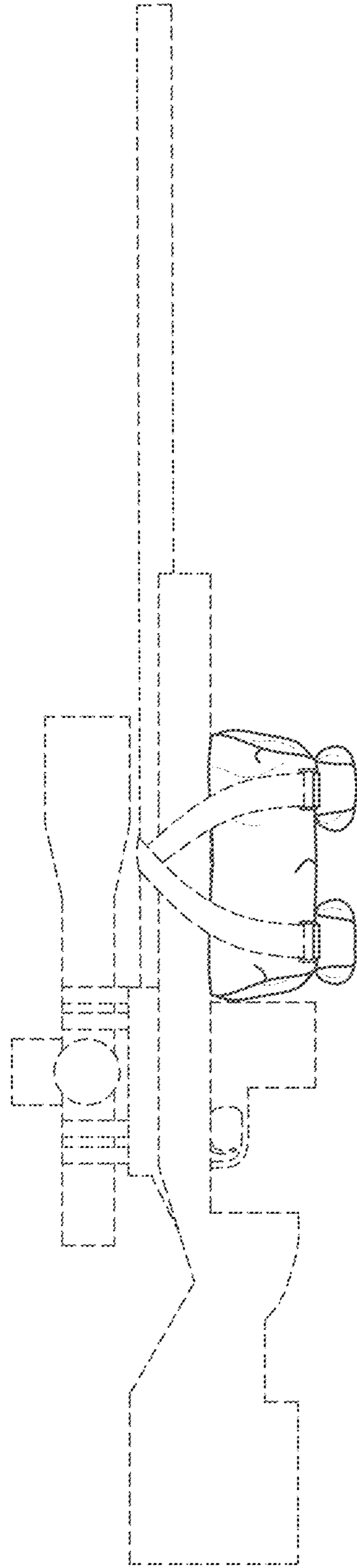

FIG. 13