



US00D901702S

(12) **United States Design Patent**
Weinstein

(10) **Patent No.:** **US D901,702 S**

(45) **Date of Patent:** **** Nov. 10, 2020**

(54) **HOT AND COLD PACK FOR THE FACE**

(71) Applicant: **Randy H. Weinstein**, Windsor, CA
(US)

(72) Inventor: **Randy H. Weinstein**, Windsor, CA
(US)

(**) Term: **15 Years**

(21) Appl. No.: **29/689,466**

(22) Filed: **Apr. 30, 2019**

Related U.S. Application Data

(62) Division of application No. 35/001,426, filed on Sep. 11, 2017 (U.S. filing date under 35 U.S.C. 384), and having an international filing date of Sep. 11, 2017, now Pat. No. Des. 868,275.

(51) **LOC (12) Cl.** **24-04**

(52) **U.S. Cl.**
USPC **D24/206**

(58) **Field of Classification Search**
USPC D24/206-270
CPC A61F 2007/108; A61F 2007/0228; A61F 2007/0036; A61F 2007/0024; A61F 2007/0042; A61F 2007/0231; A61F 2007/0003; A61F 2007/0011; A61F 2007/0029

See application file for complete search history.

(56) **References Cited**

U.S. PATENT DOCUMENTS

D668,344 S * 10/2012 Baumwald D24/206
D715,453 S * 10/2014 In D24/206
D715,454 S * 10/2014 Riggons D24/206
D767,777 S * 9/2016 Qin D24/207

D767,779 S * 9/2016 Qin D24/207
D828,569 S * 9/2018 Mercurio D24/191
D870,906 S * 12/2019 Bruder D24/206
D871,598 S * 12/2019 Bruder D24/206
D876,656 S * 2/2020 Campbell D24/207
D877,350 S * 3/2020 Biser D24/206

* cited by examiner

Primary Examiner — Michael A. Pratt

(74) *Attorney, Agent, or Firm* — Benjamin D. Rotman;
Rosenbaum IP, P.C.

(57) **CLAIM**

The ornamental design for a hot and cold pack for the face, as shown and described.

DESCRIPTION

FIG. 1 is a front perspective view of a hot and cold pack for the face in accordance with the invention with attachment straps shown in broken lines;

FIG. 2 is a front view of FIG. 1 with attachment straps shown in broken lines;

FIG. 3 is a back view of FIG. 1 with attachment straps shown in broken lines;

FIG. 4 is a left view of FIG. 1 with attachment straps shown in broken lines;

FIG. 5 is a right view of FIG. 1 with attachment straps shown in broken lines;

FIG. 6 is a top view of FIG. 1 with attachment straps shown in broken lines; and,

FIG. 7 is a bottom view of FIG. 1 with attachment straps shown in broken lines.

The broken lines are for environmental purposes only and form no part of the claimed design.

1 Claim, 5 Drawing Sheets

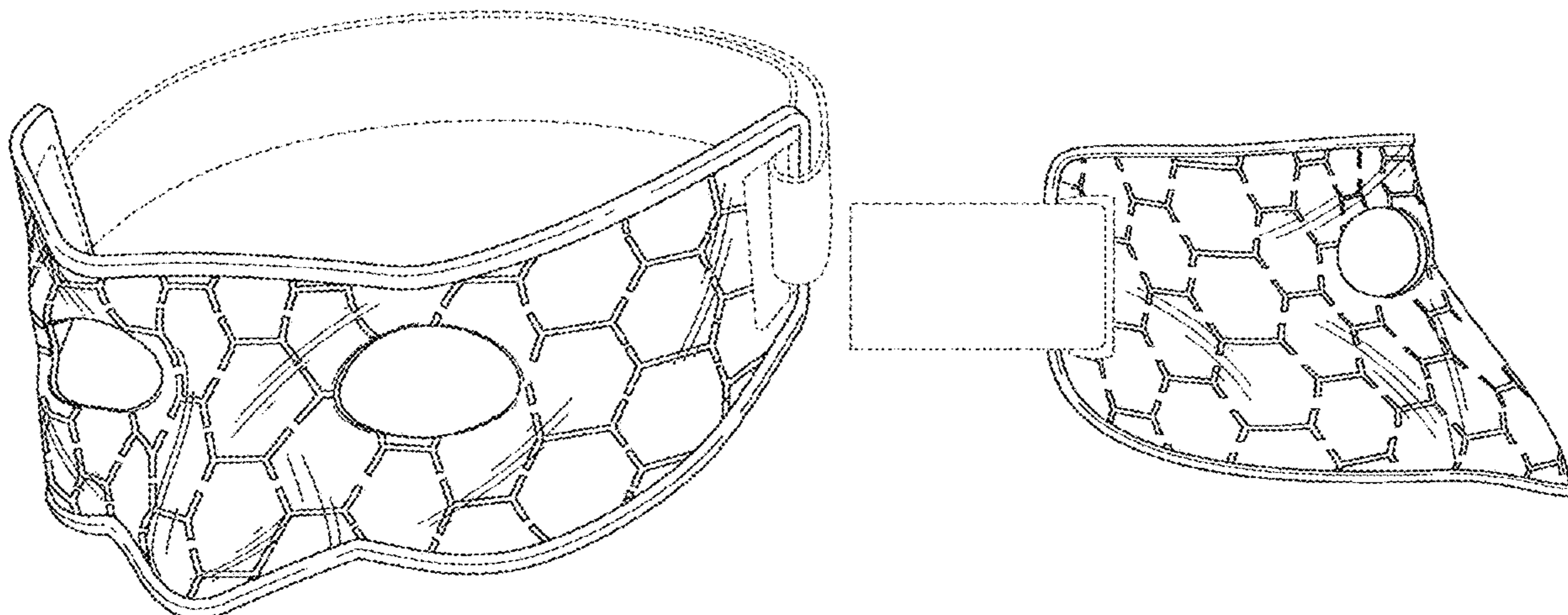

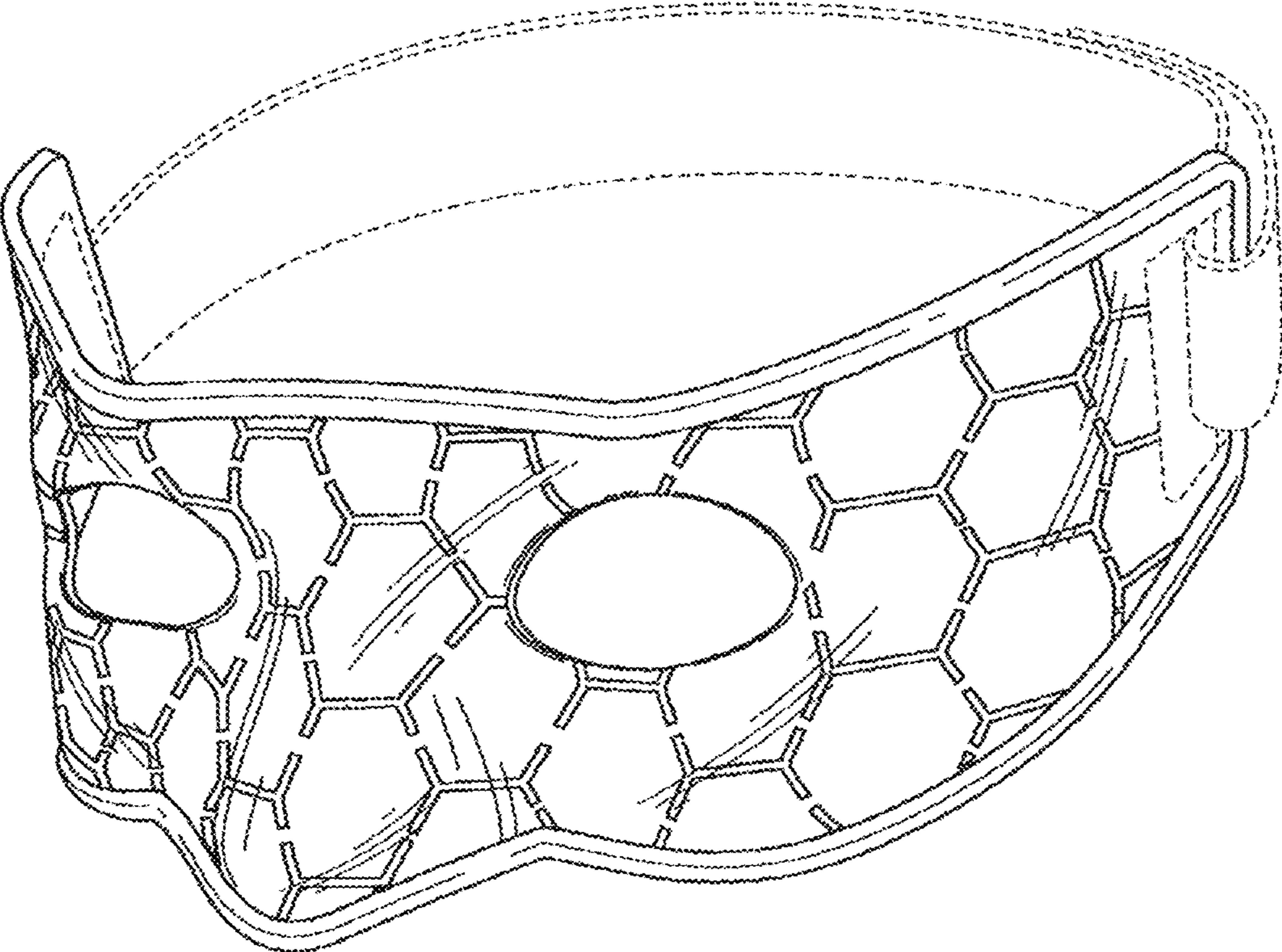

FIG. 1

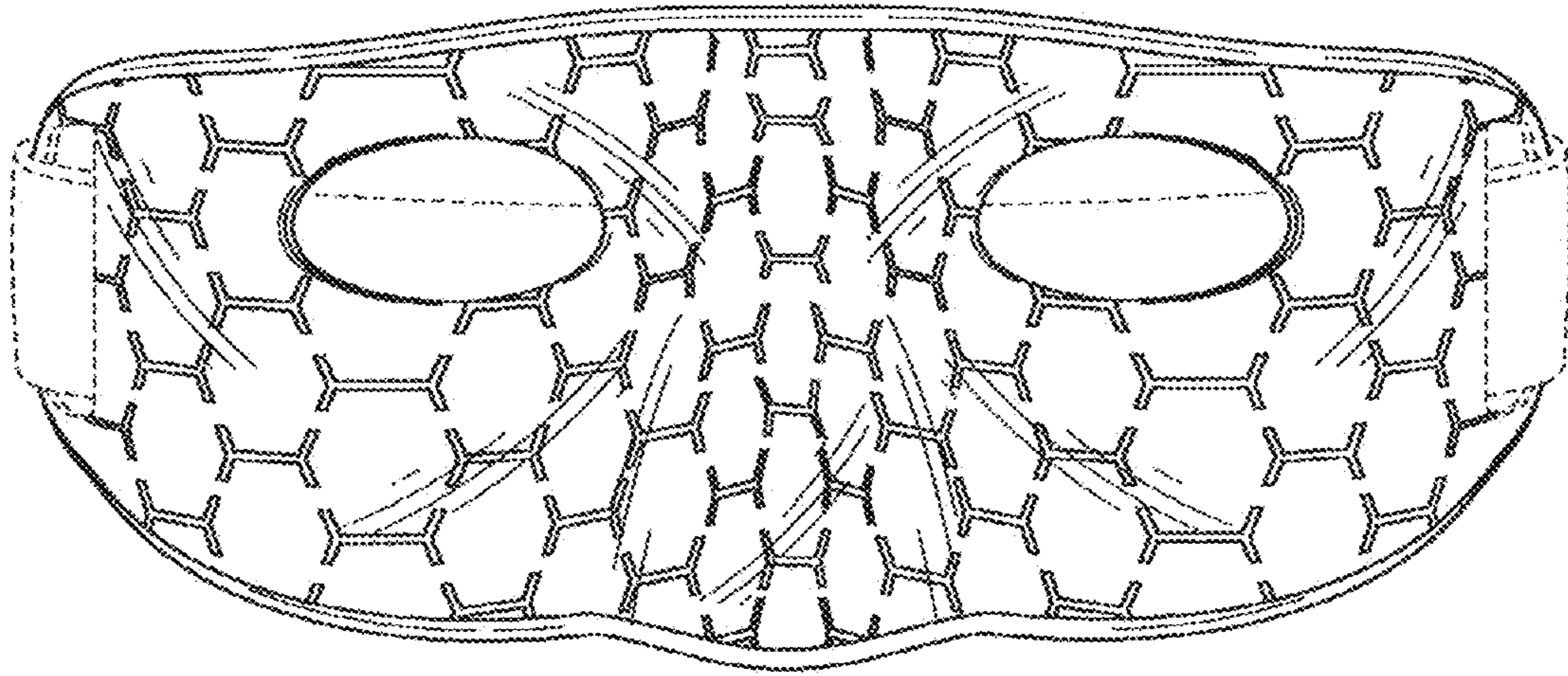

FIG. 2

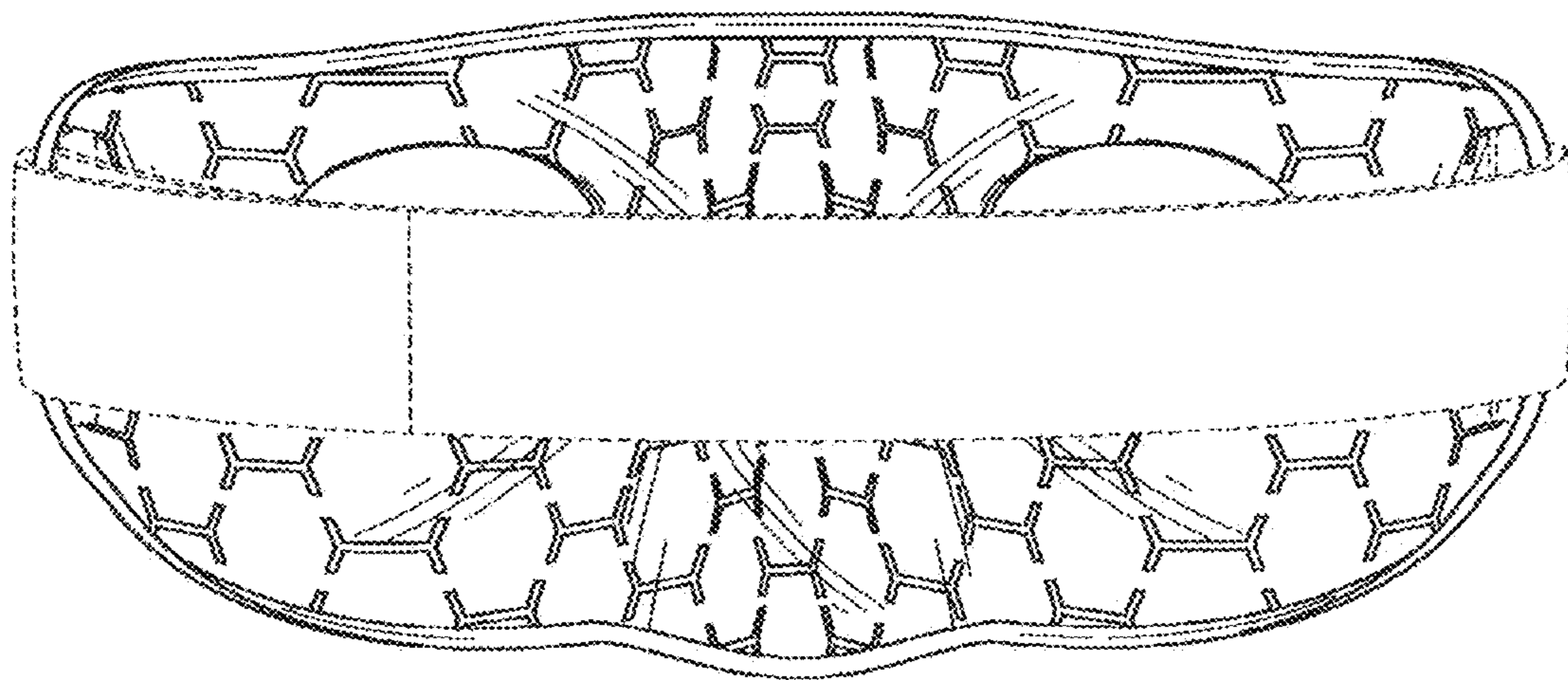

FIG. 3

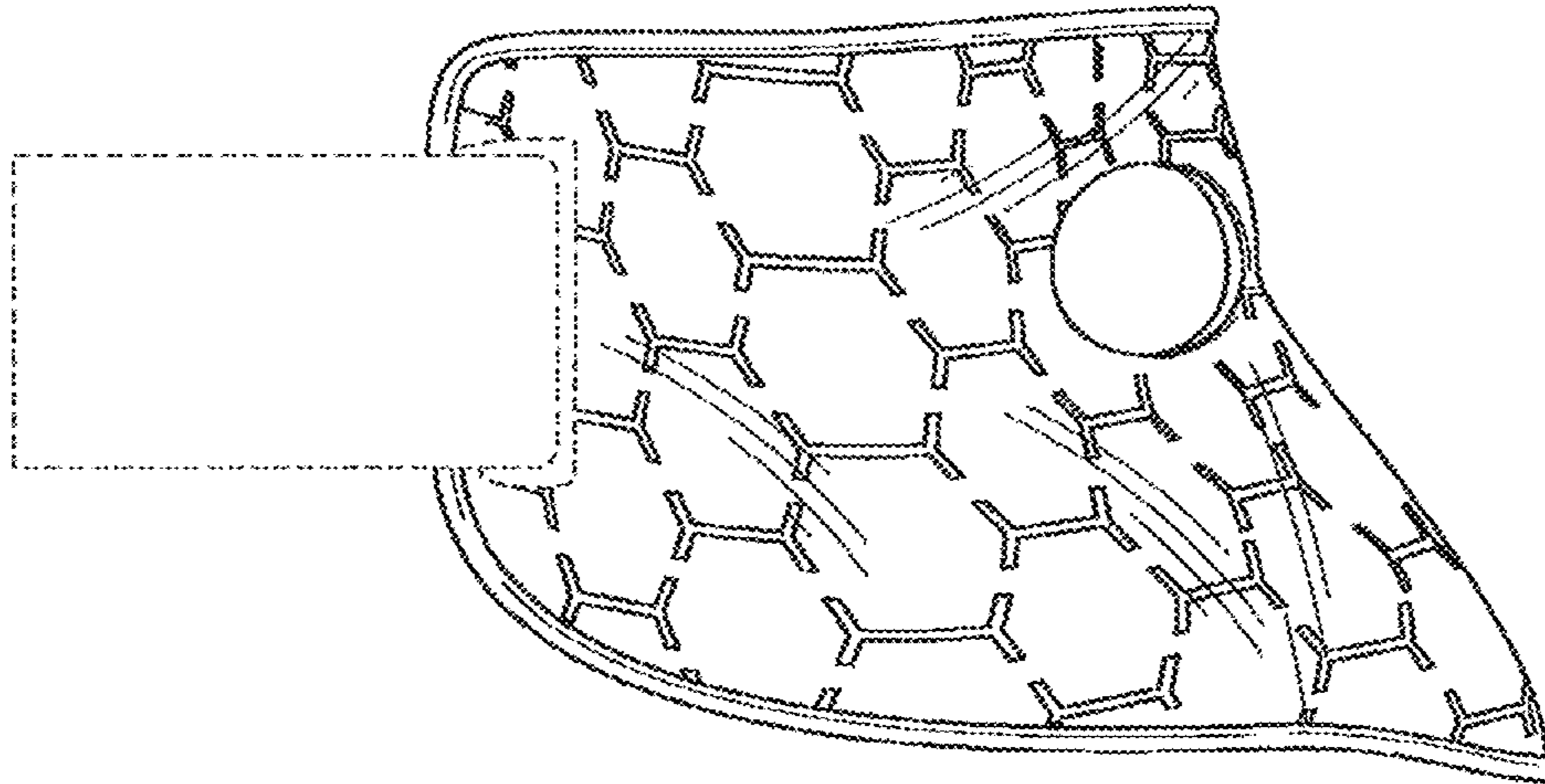

FIG. 4

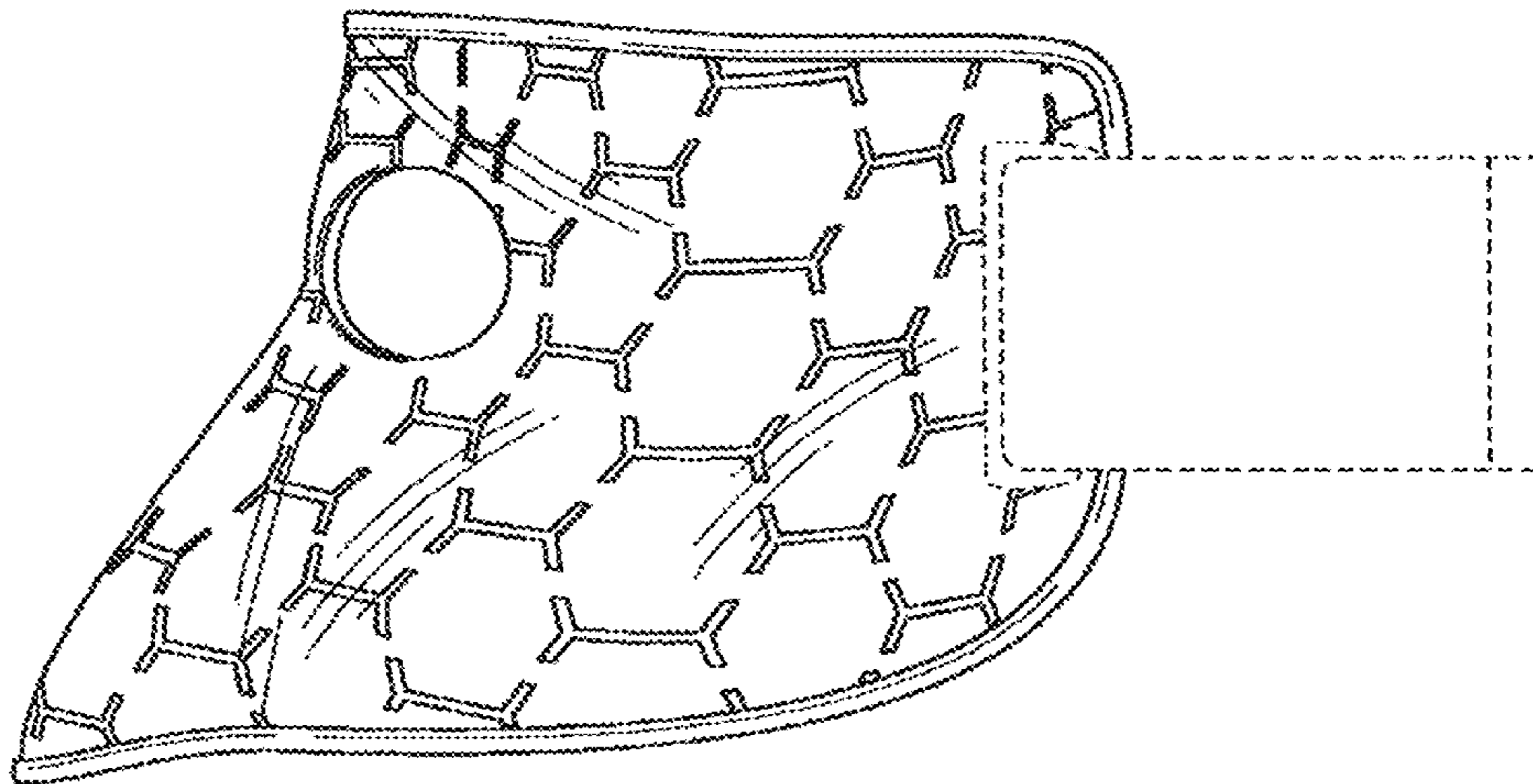

FIG. 5



FIG. 6

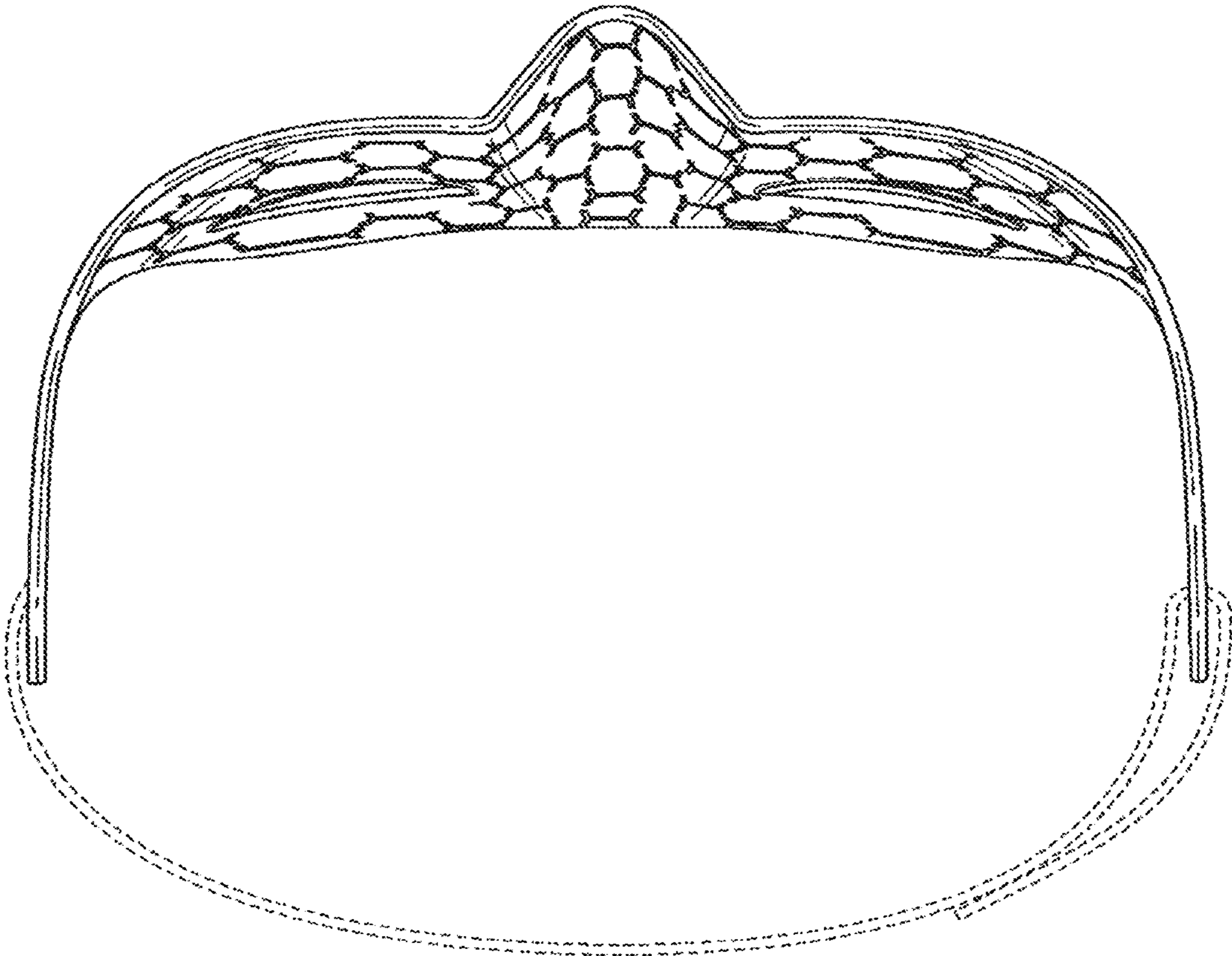

FIG. 7