



US00D901691S

(12) **United States Design Patent** (10) **Patent No.:** **US D901,691 S**
Iida (45) **Date of Patent:** **** Nov. 10, 2020**

(54) **INCUBATOR**

(71) Applicant: **PHC CORPORATION**, Toon (JP)

(72) Inventor: **Yoshiaki Iida**, Osaka (JP)

(73) Assignee: **PHC CORPORATION**, Toon (JP)

(**) Term: **15 Years**

(21) Appl. No.: **29/688,744**

(22) Filed: **Apr. 24, 2019**

(30) **Foreign Application Priority Data**

Nov. 12, 2018 (JP) 2018-024730

(51) **LOC (12) Cl.** **24-01**

(52) **U.S. Cl.**
USPC **D24/163**

(58) **Field of Classification Search**
USPC D24/163, 164, 185, 202, 209, 231, 217;
D30/108, 117, 199; D10/50
CPC A61G 11/00; A61G 11/002; A61G 11/005;
A61G 11/009; A61M 21/0094; A47C
29/003
See application file for complete search history.

(56) **References Cited**

U.S. PATENT DOCUMENTS

5,690,055 A * 11/1997 Wenstrand A01K 41/00
119/309
7,966,973 B1 * 6/2011 Adragna, Jr. A01K 41/00
119/311
D655,870 S * 3/2012 Carlin, Jr. D30/117
D710,503 S * 8/2014 Hudson D24/163
RE46,016 E * 5/2016 Scherbing D24/163

D819,821 S 6/2018 Yamanaka
D845,180 S * 4/2019 Lait D24/163
D876,021 S * 2/2020 Gevaert D30/108
D879,316 S * 3/2020 Ullman D24/163

FOREIGN PATENT DOCUMENTS

EM D004684603-0001 1/2018

* cited by examiner

Primary Examiner — Anhdao Doan

(74) *Attorney, Agent, or Firm* — Brinks Gilson & Lione

(57) **CLAIM**

I claim the ornamental design for an incubator, as shown and described.

DESCRIPTION

FIG. 1 is a front perspective view showing an incubator of the present invention;
FIG. 2 is a rear perspective view thereof;
FIG. 3 is a front view thereof;
FIG. 4 is a rear view thereof;
FIG. 5 is a left side view thereof;
FIG. 6 is a right side view thereof;
FIG. 7 is a top plan view thereof;
FIG. 8 is a bottom view thereof;
FIG. 9 is a front perspective view with a cover being opened; and,
FIG. 10 is another front perspective view with the cover being opened and a cartridge shown inside by broken lines. The broken lines depicting a cartridge in FIG. 10 represent an environment, and the remaining broken lines depict portions of the incubator that form no part of the claimed design. The broken lines and the unshaded surfaces form no part of the claimed design.

1 Claim, 10 Drawing Sheets

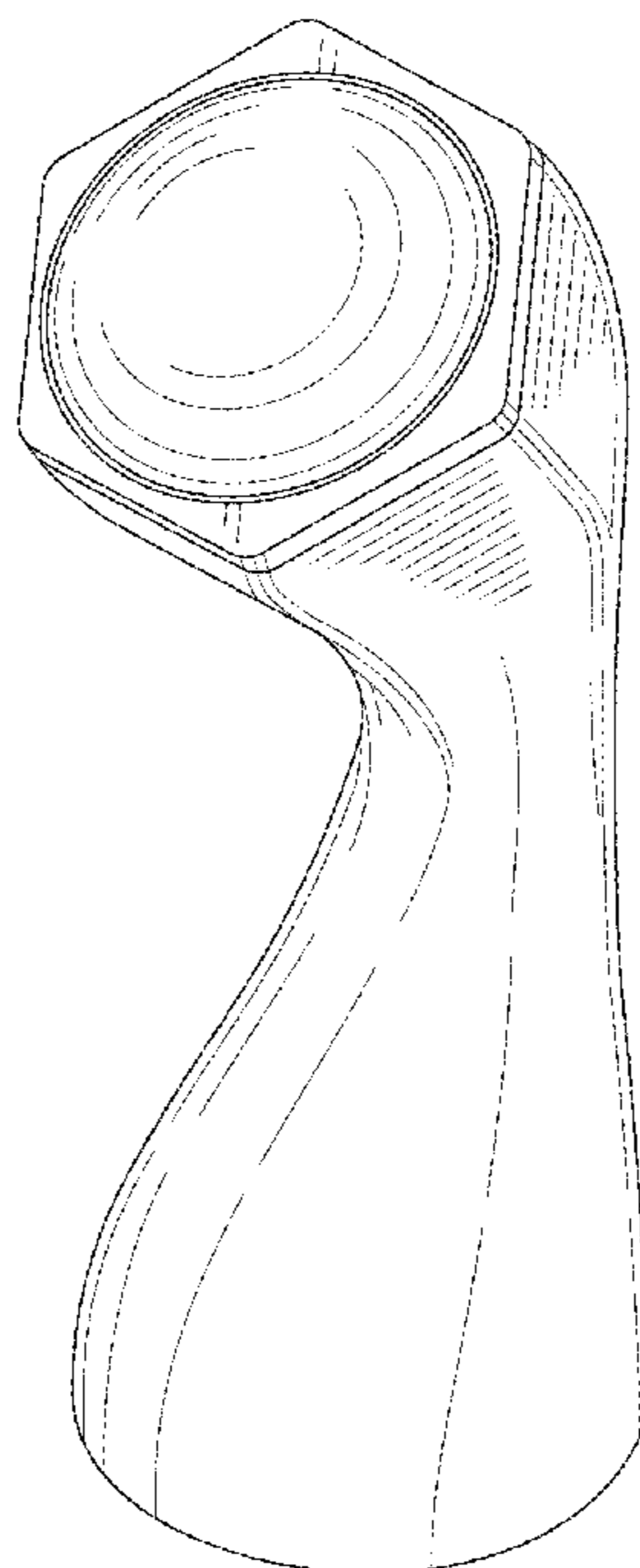

FIG. 1

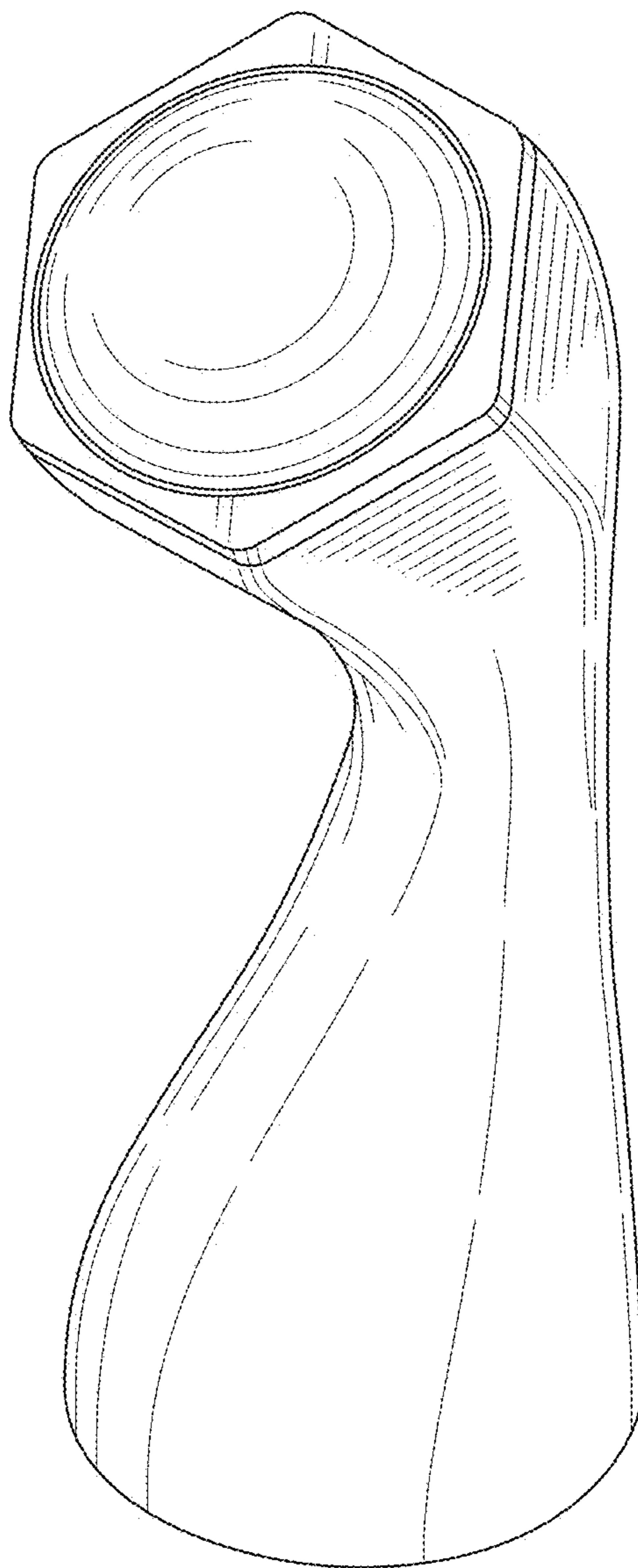

FIG. 2

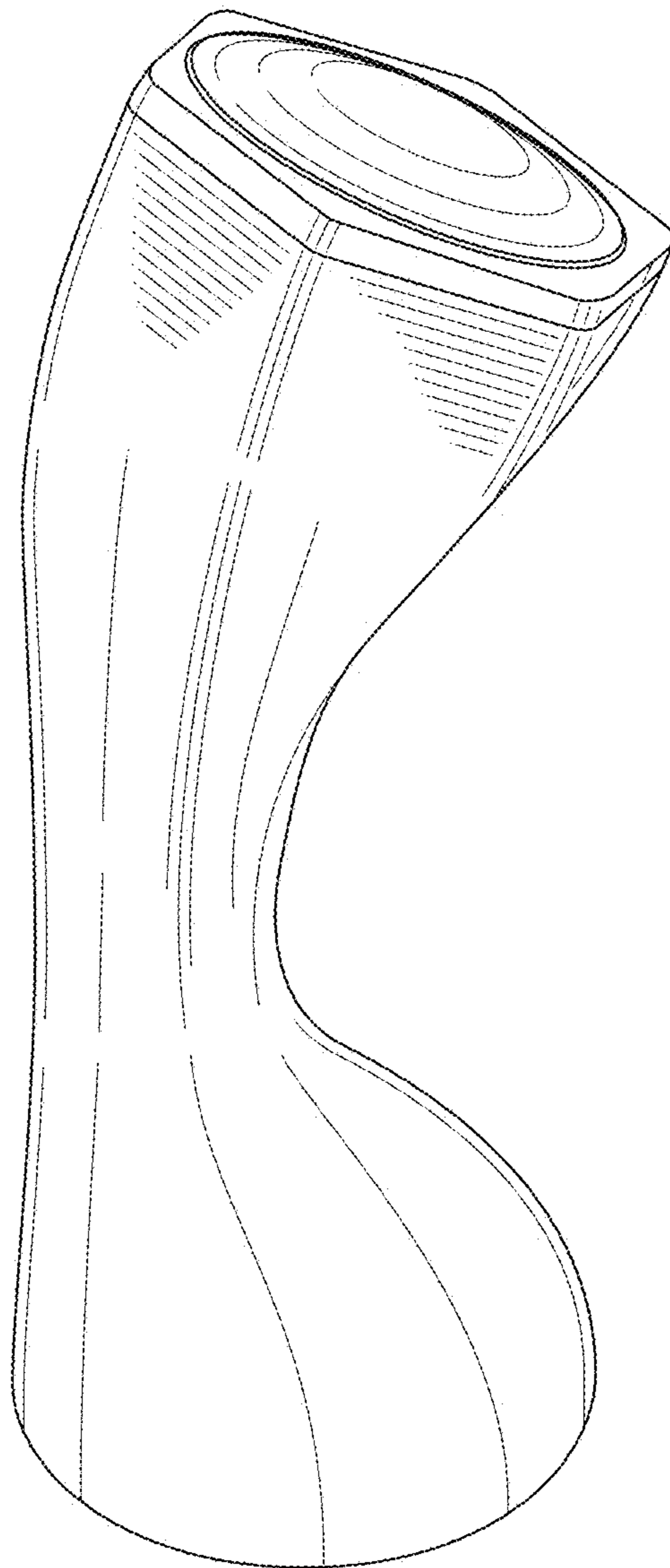

FIG. 3

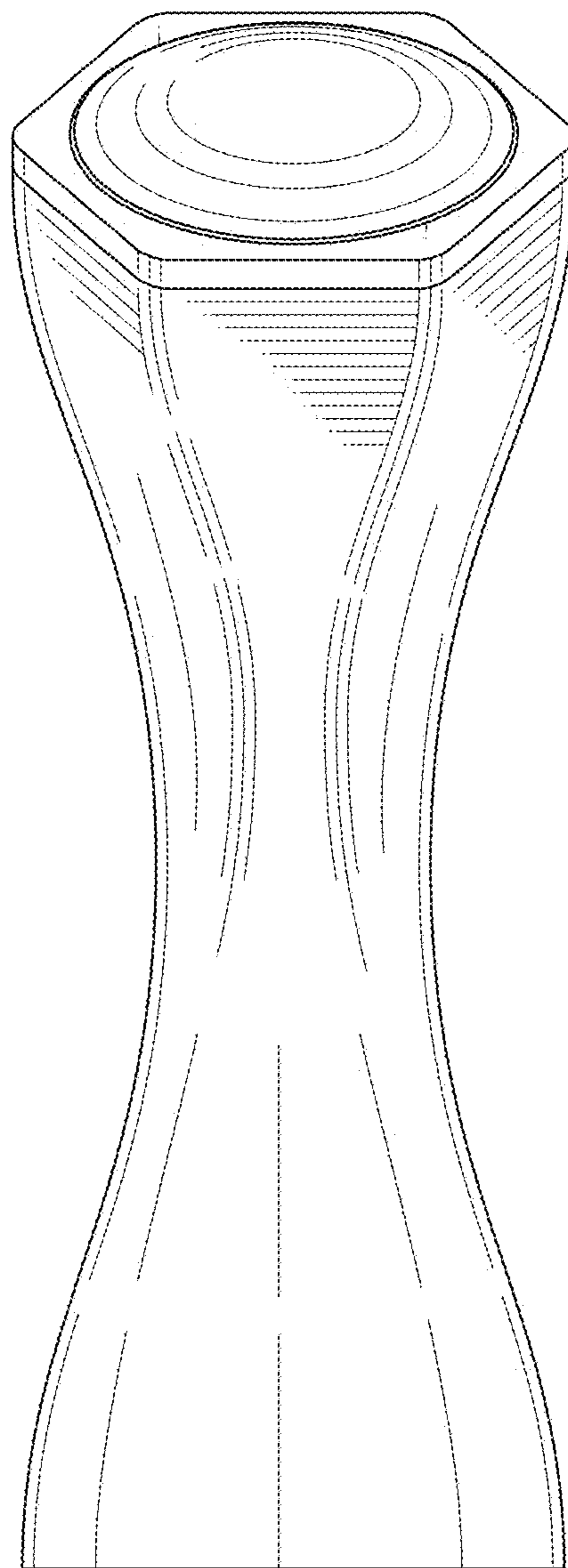

FIG. 4

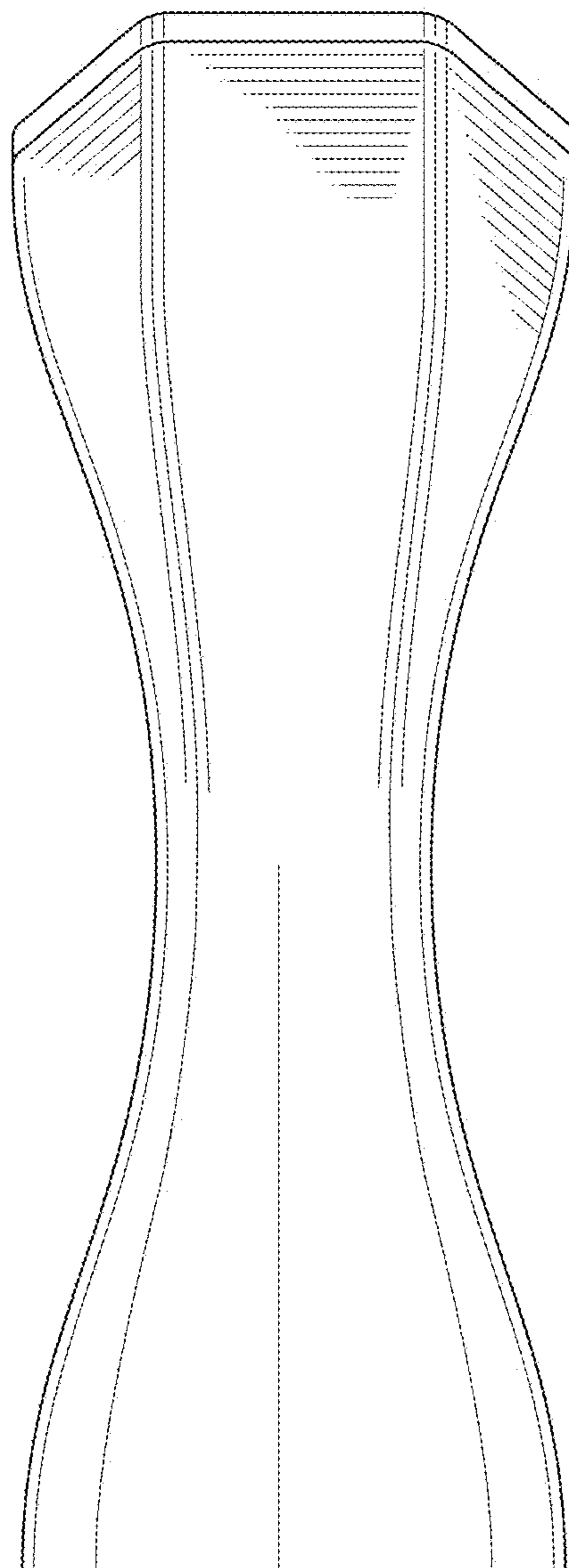

FIG. 5

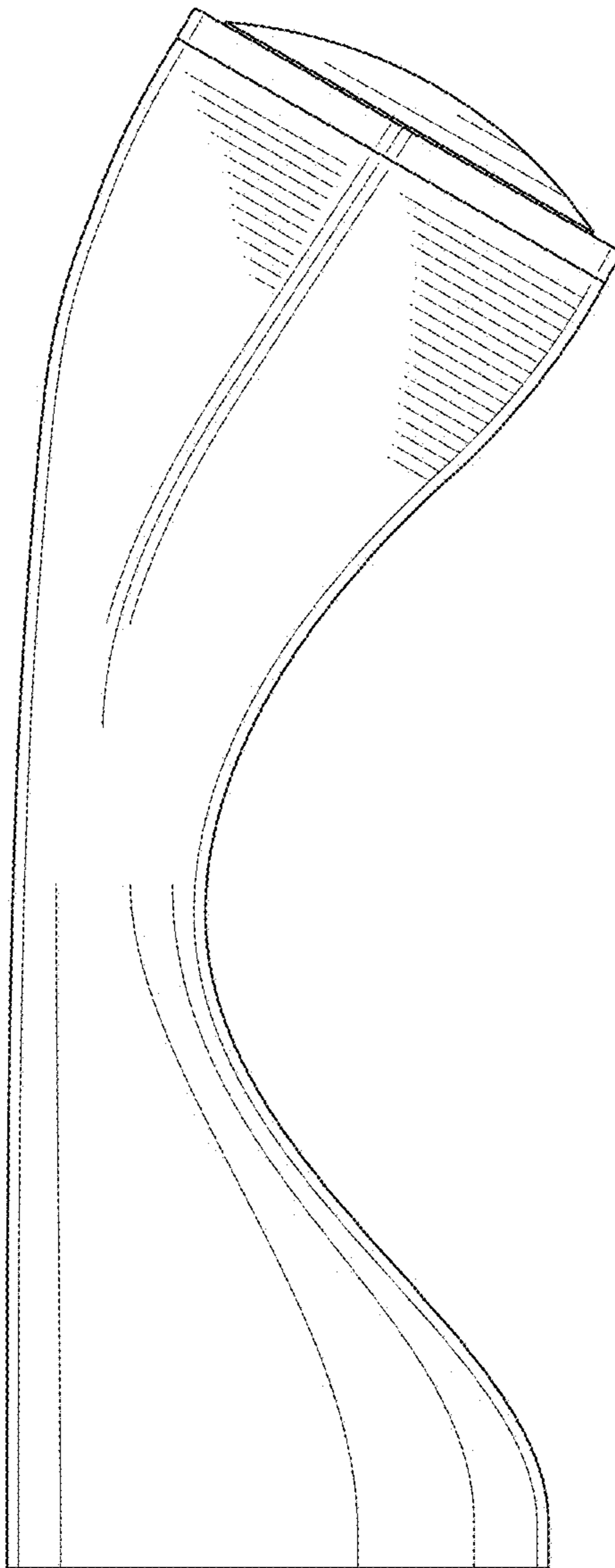

FIG. 6

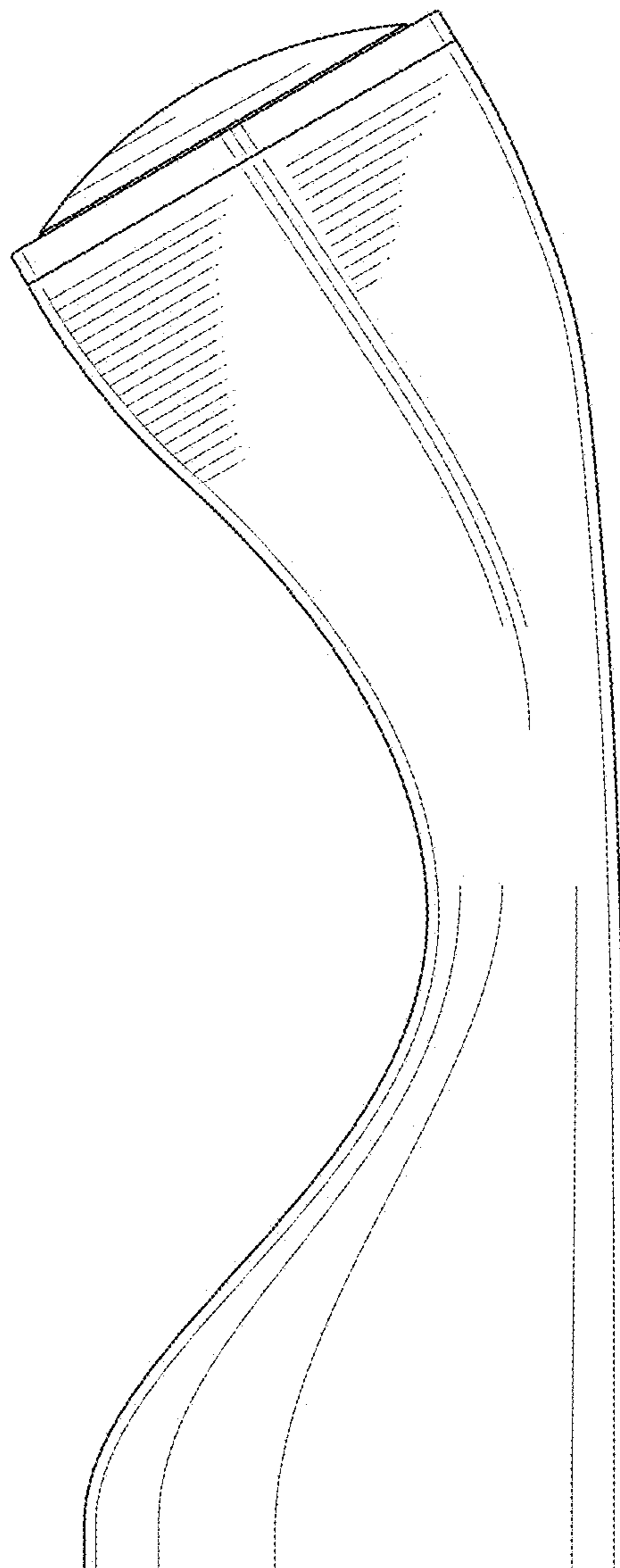

FIG. 7

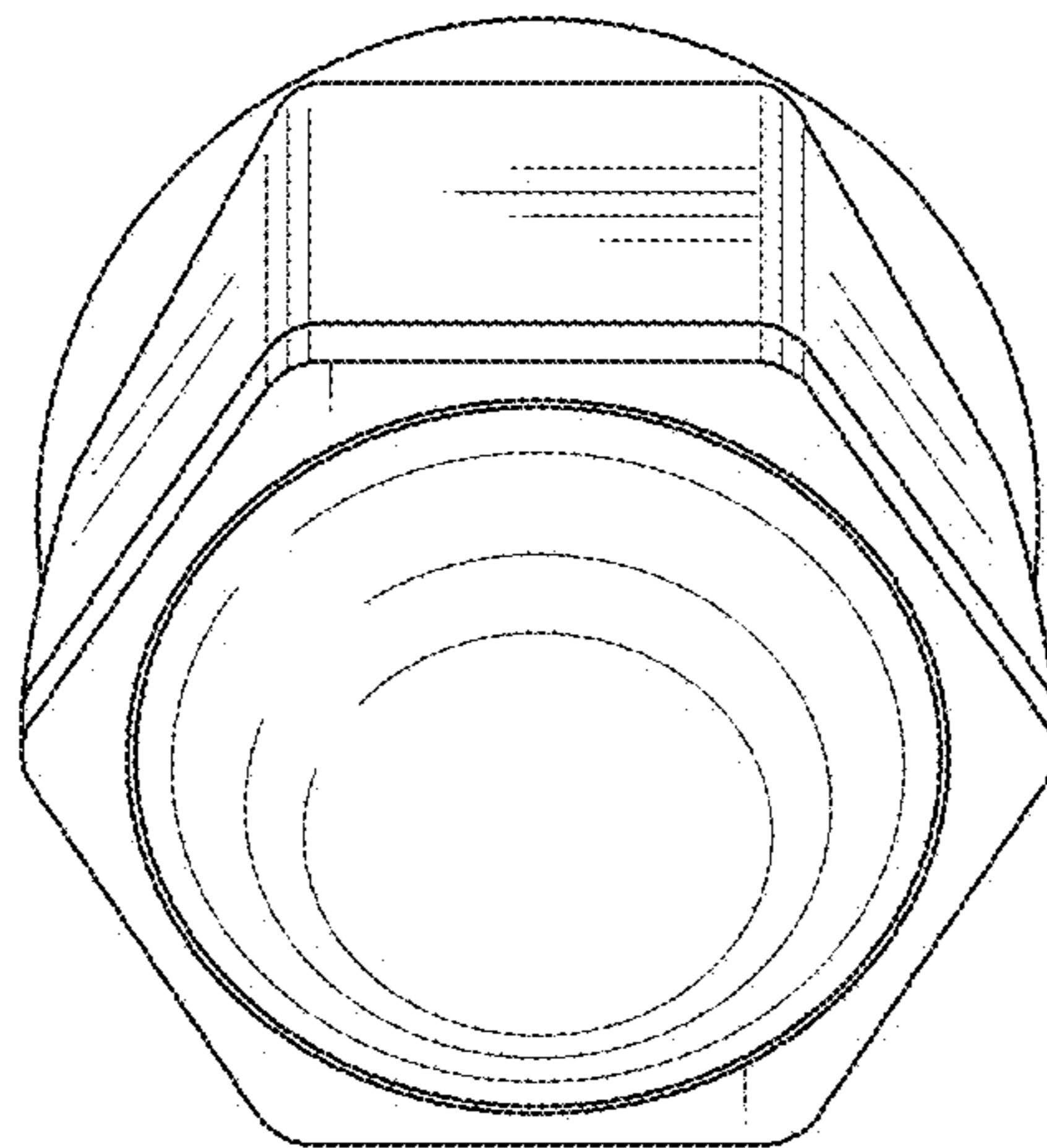

FIG. 8

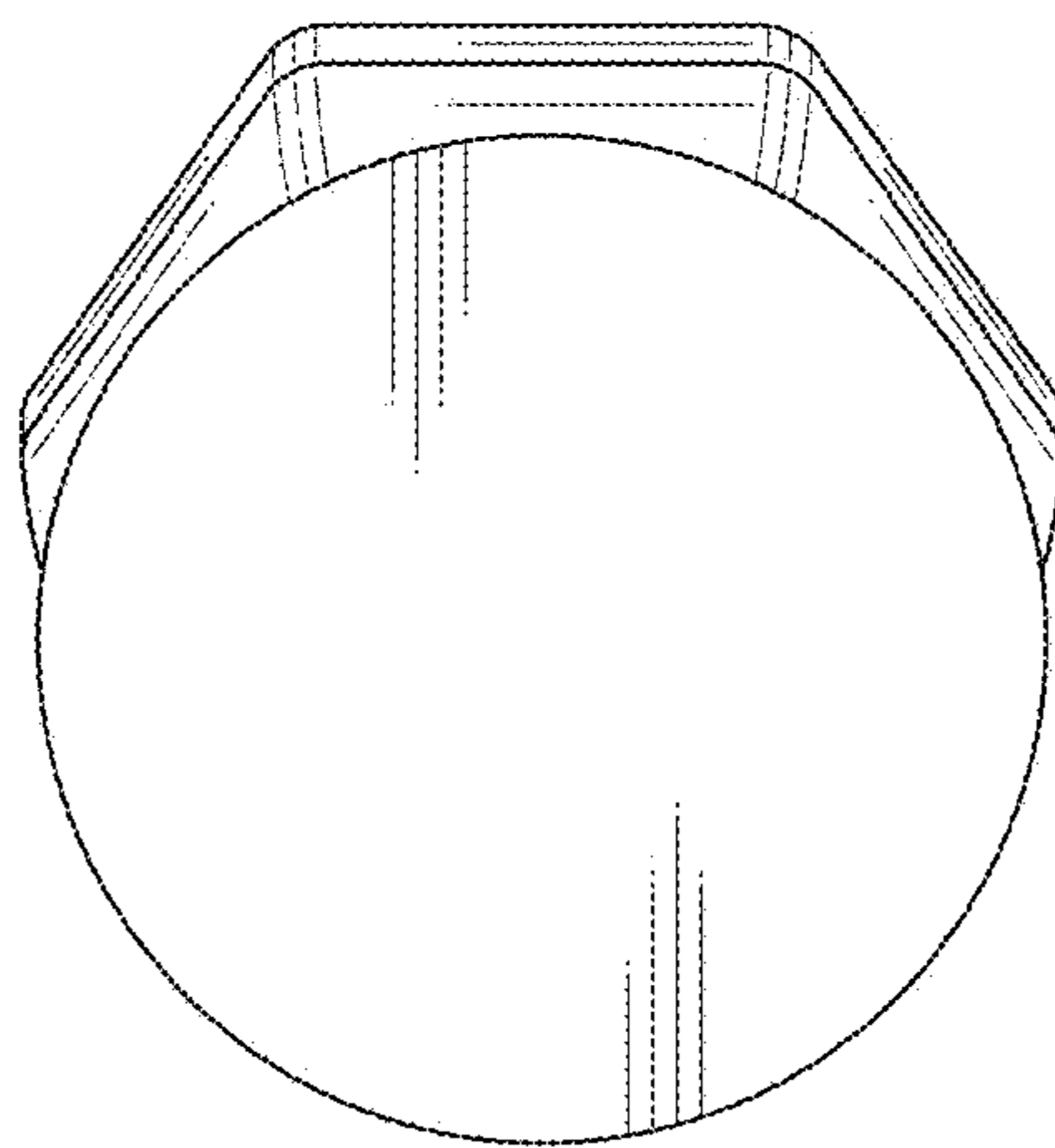

FIG. 9

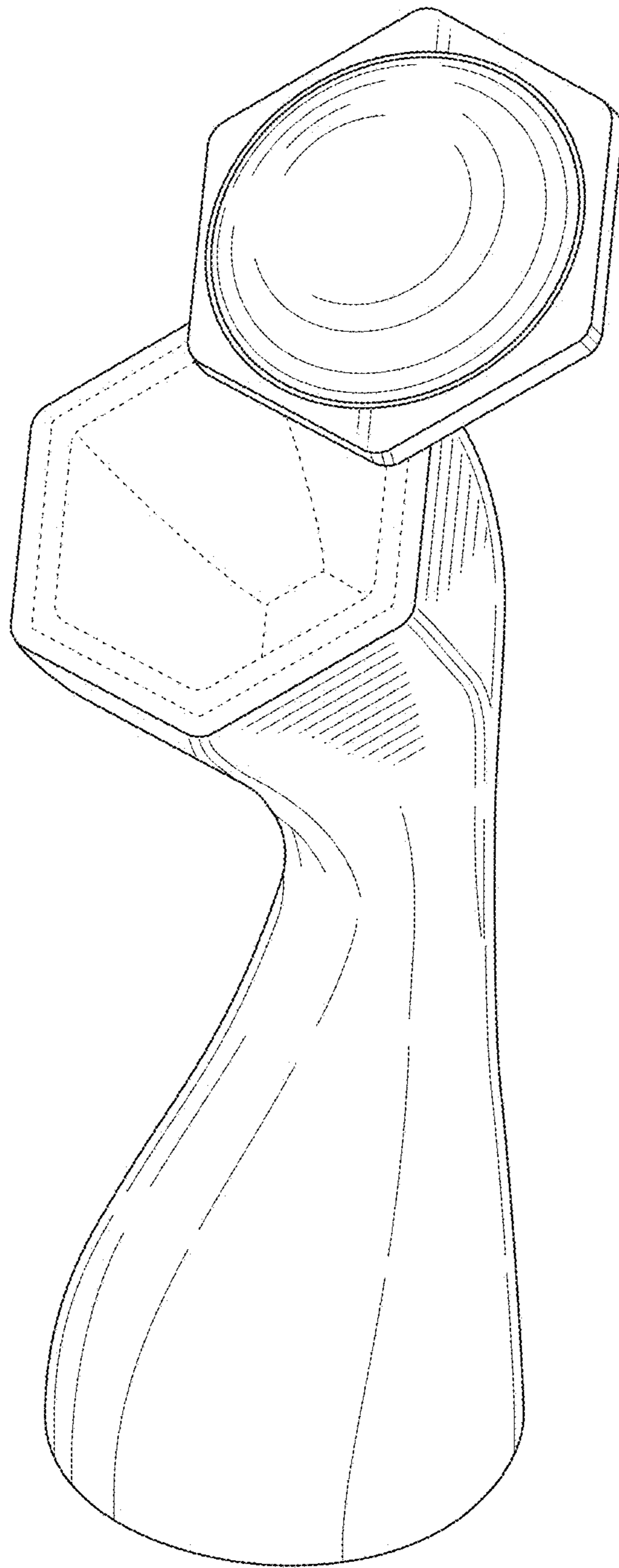

FIG. 10

