



US00D901656S

(12) **United States Design Patent**
Wardrop et al.

(10) **Patent No.:** **US D901,656 S**

(45) **Date of Patent:** **** Nov. 10, 2020**

(54) **FIREPLACE**

(71) Applicant: **Flexchanger Technologies Inc.**, West Vancouver (CA)

(72) Inventors: **Walter Wardrop**, West Vancouver (CA); **Nicholas Barber**, Mission (CA); **Robert Walter**, Burnaby (CA)

(73) Assignee: **Flexchanger Technologies Inc.**

(**) Term: **15 Years**

(21) Appl. No.: **29/701,681**

(22) Filed: **Aug. 13, 2019**

(51) **LOC (12) Cl.** **23-03**

(52) **U.S. Cl.**
USPC **D23/347**

(58) **Field of Classification Search**
USPC D23/314, 318, 320, 322, 329, 342, 343, D23/344, 347
CPC .. F24B 1/192; F24B 1/19; F24B 1/181; F24B 1/195; F24B 1/191
See application file for complete search history.

(56) **References Cited**

U.S. PATENT DOCUMENTS

D299,856 S * 2/1989 Mowrey D23/347
D489,807 S * 5/2004 Rumens D23/404
6,910,477 B1 * 6/2005 Barber F24C 3/006
126/503
D519,203 S * 4/2006 Haas D23/405

D664,638 S * 7/2012 Benedetti D23/404
RE45,934 E * 3/2016 Kent D23/343
2008/0216818 A1 * 9/2008 Rumens F24B 1/198
126/500

FOREIGN PATENT DOCUMENTS

WO WO-2005100862 A2 * 10/2005 F24B 1/08

* cited by examiner

Primary Examiner — Ania Aman

(74) *Attorney, Agent, or Firm* — Baumgartner Patent Law; Marc Baumgartner

(57) **CLAIM**

The ornamental design for a fireplace, as shown and described.

DESCRIPTION

FIG. 1 is a front-perspective view of a fireplace embodying our new design;
FIG. 2 is a front-side view of the fireplace of FIG. 1;
FIG. 3 is a back-side view of the fireplace of FIG. 1;
FIG. 4 is a left-side view of the fireplace of FIG. 1;
FIG. 5 is a right-side view of the fireplace of FIG. 1;
FIG. 6 is a top-side view of the fireplace of FIG. 1; and,
FIG. 7 is a bottom-side view of the fireplace of FIG. 1.
The broken lines show portions of the article not claimed and form no part of the claimed design.

1 Claim, 5 Drawing Sheets

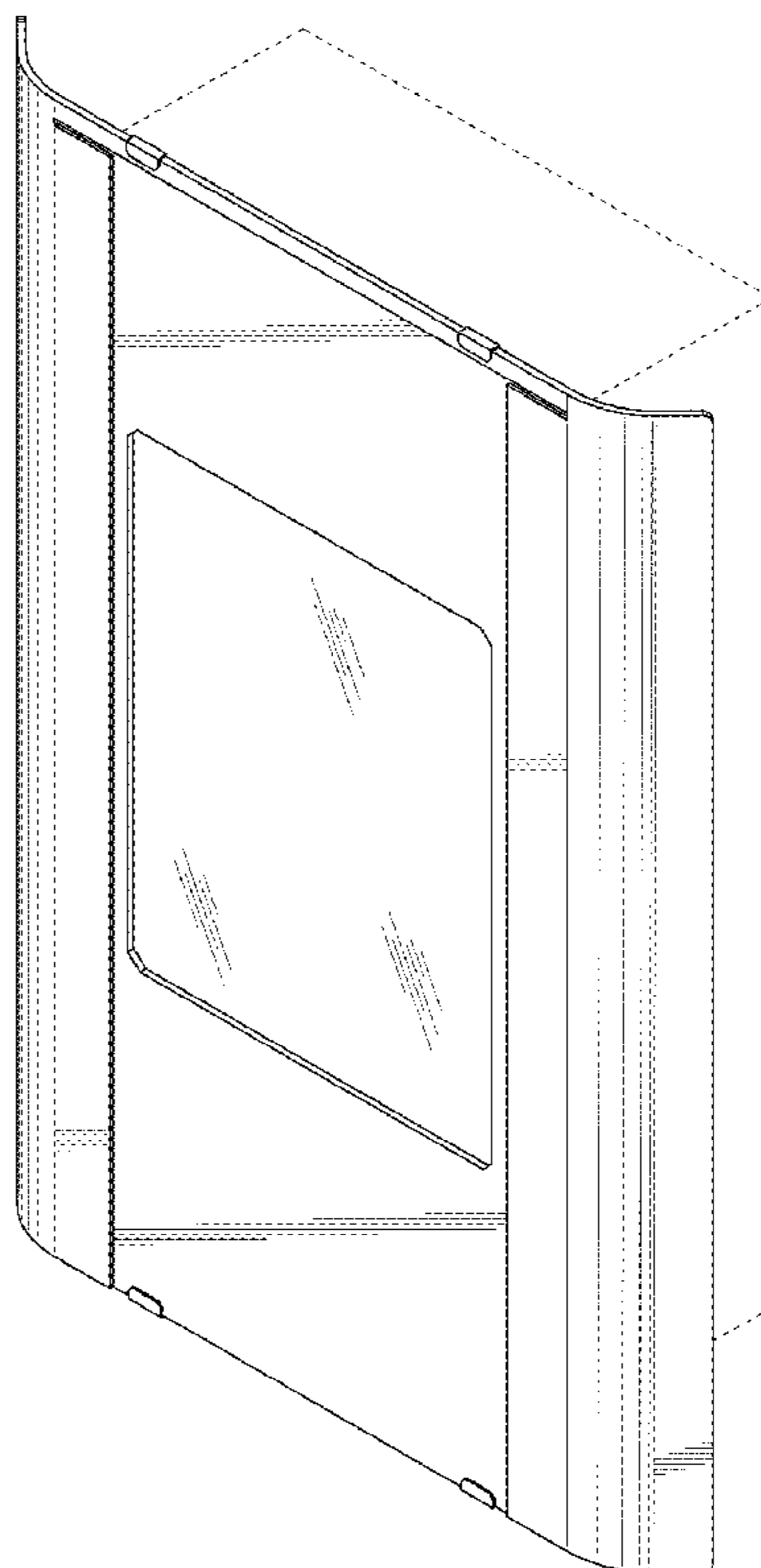

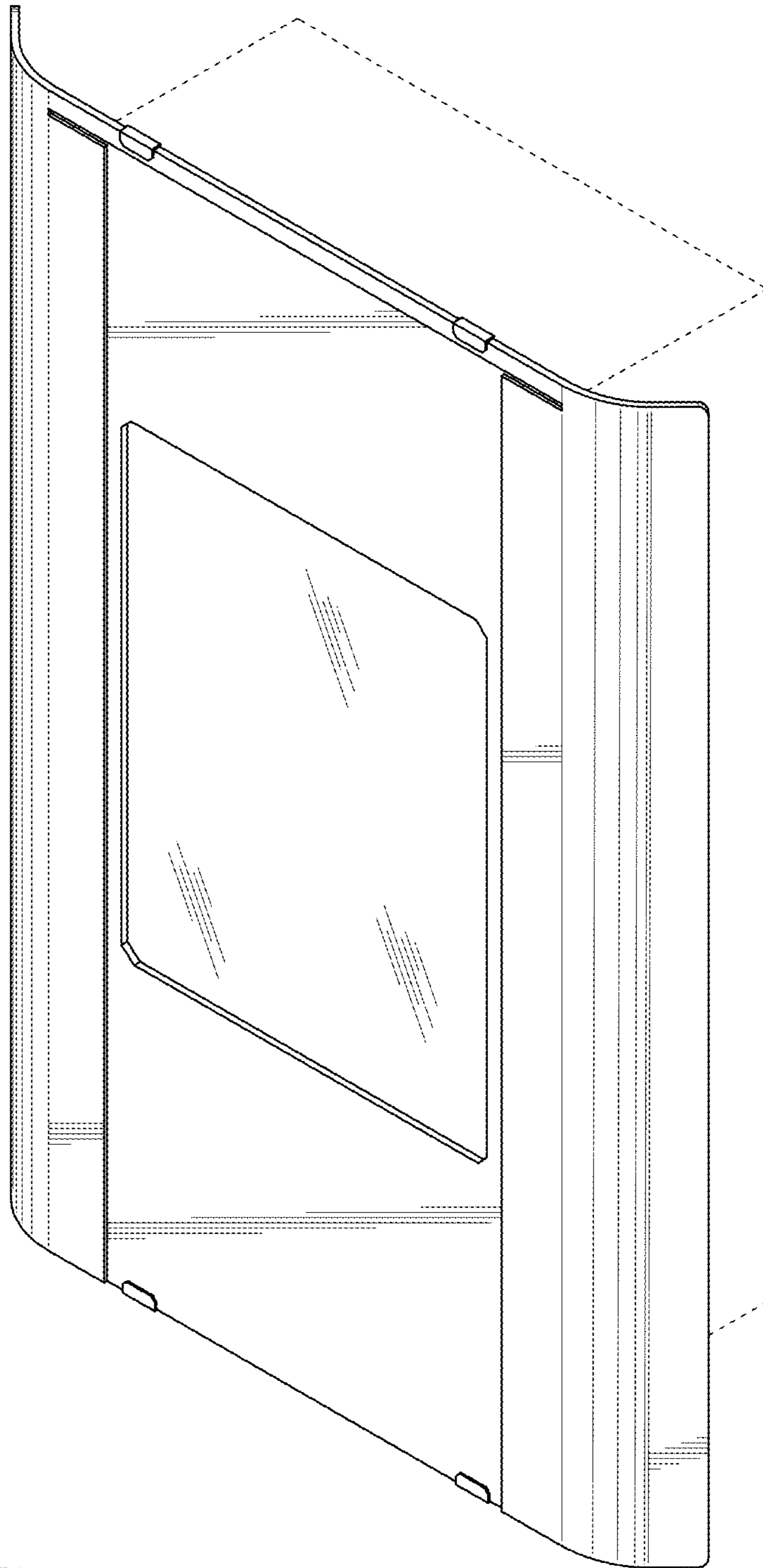

FIG. 1

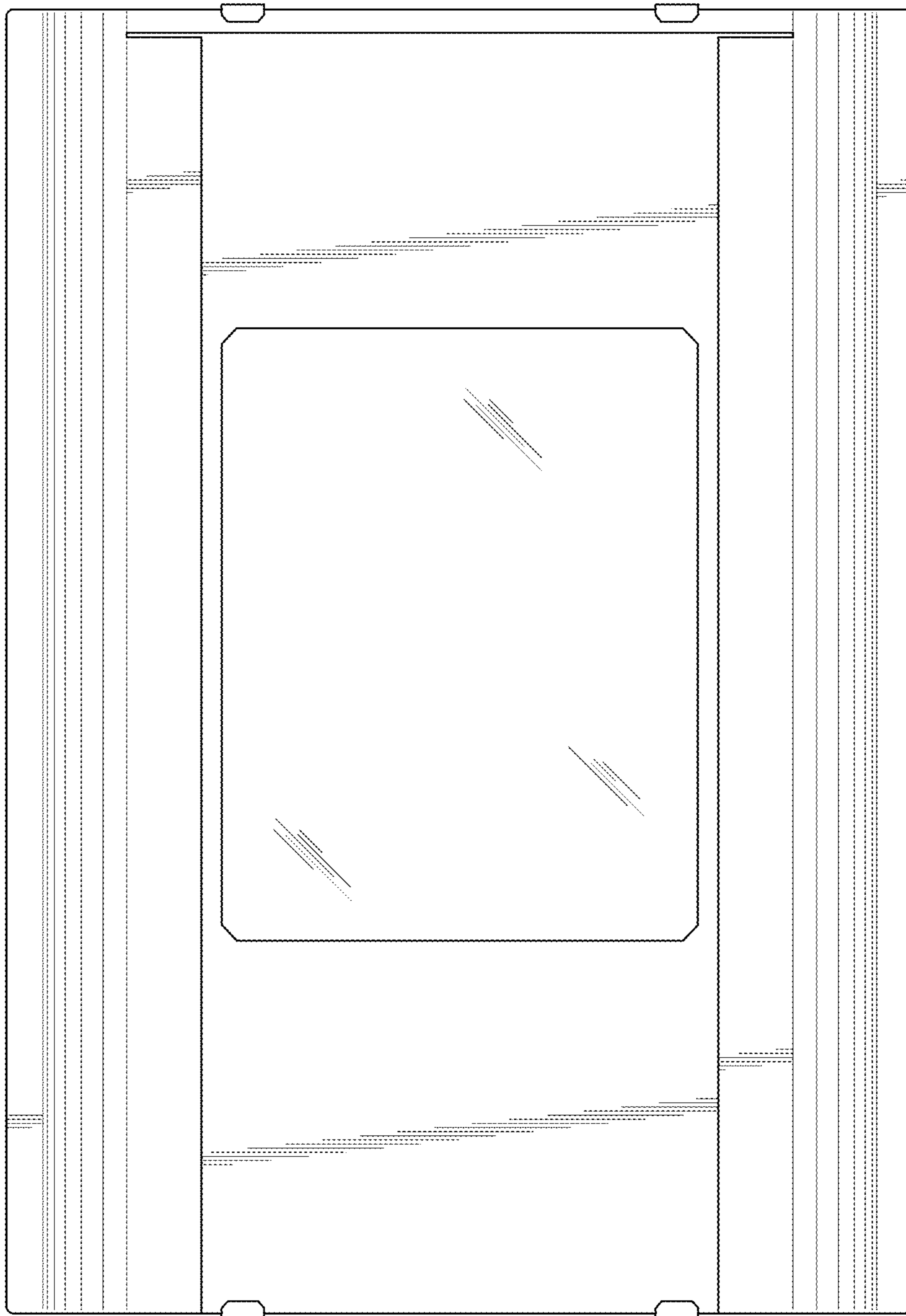

FIG. 2

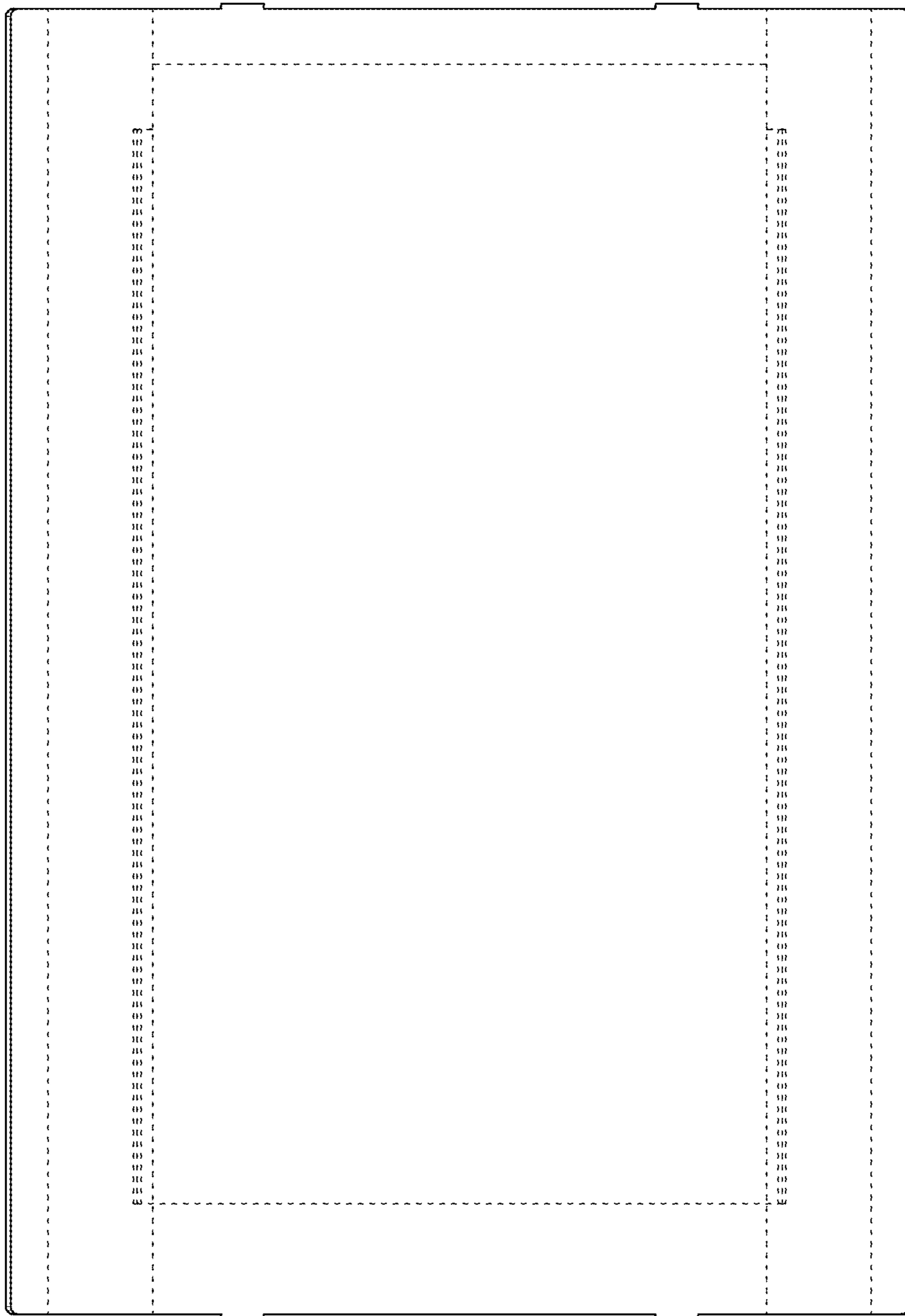

FIG. 3

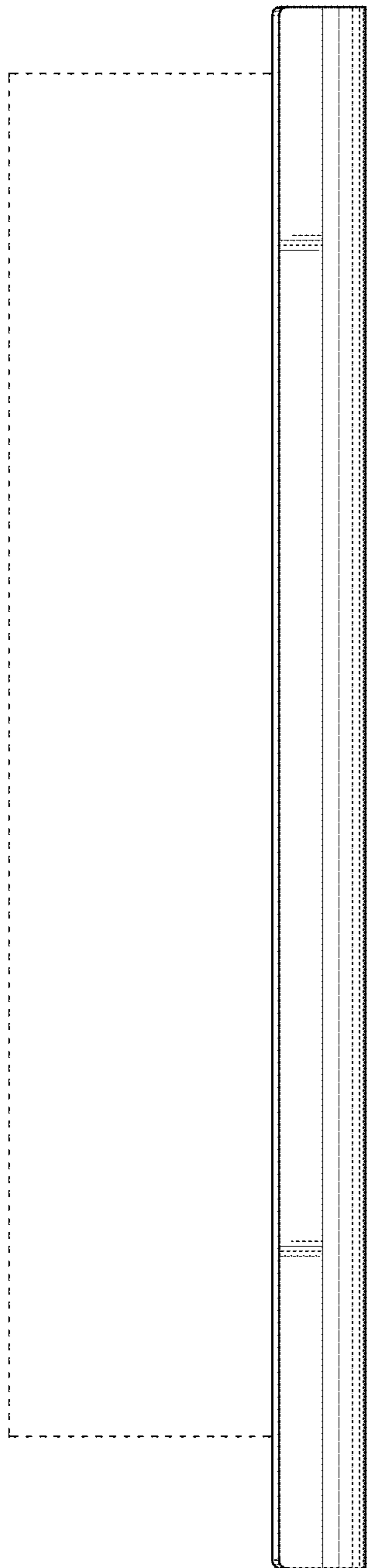

FIG. 4

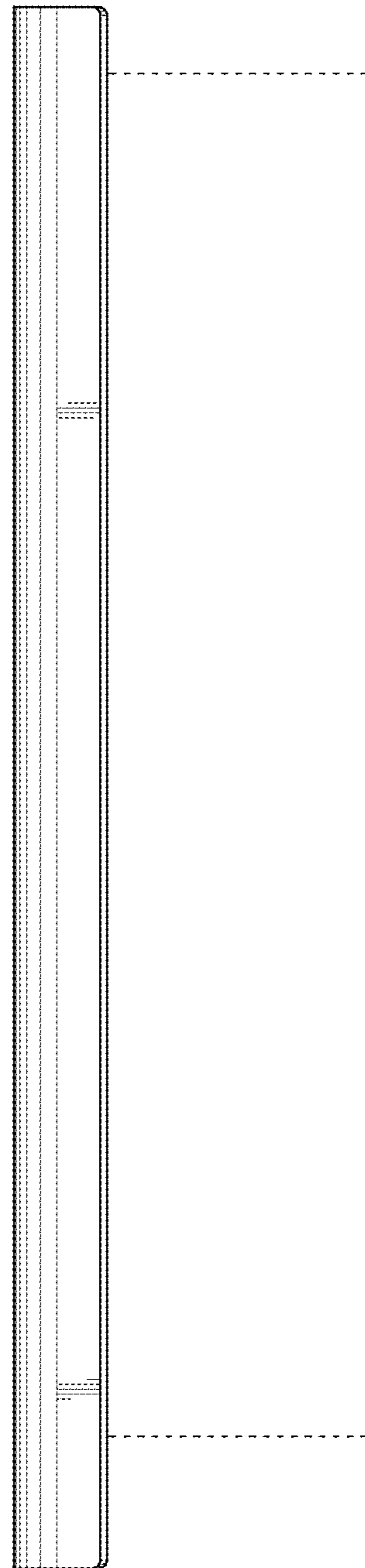

FIG. 5

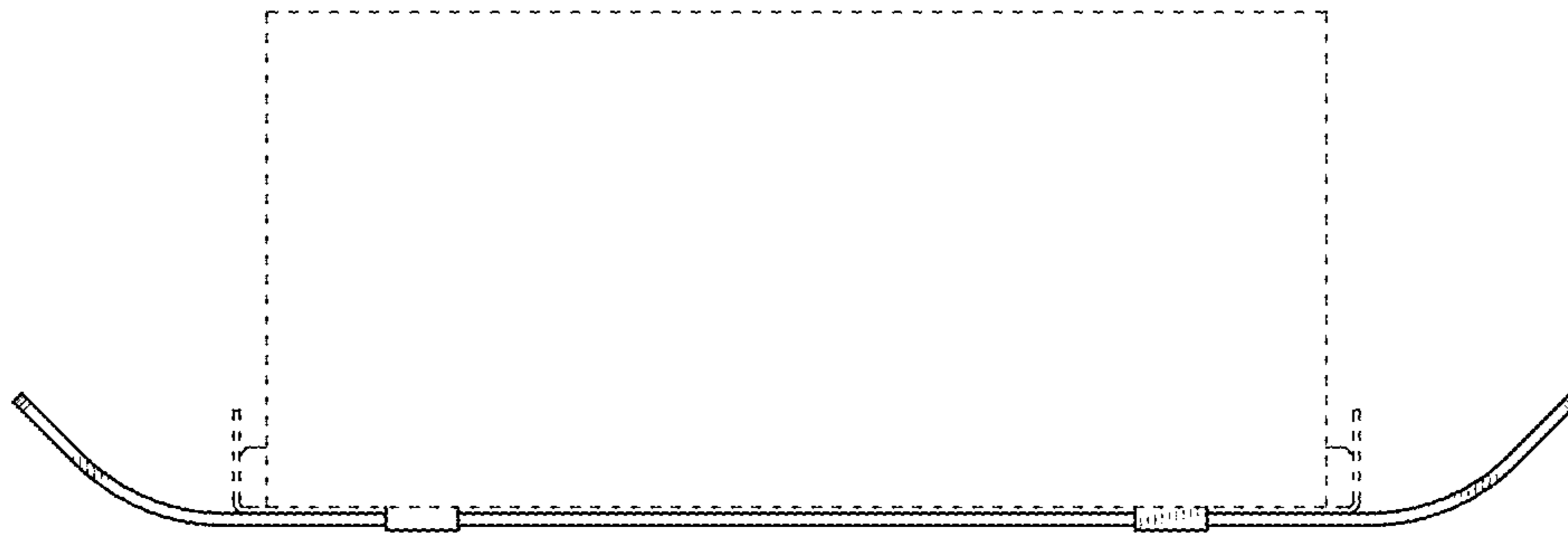

FIG. 6

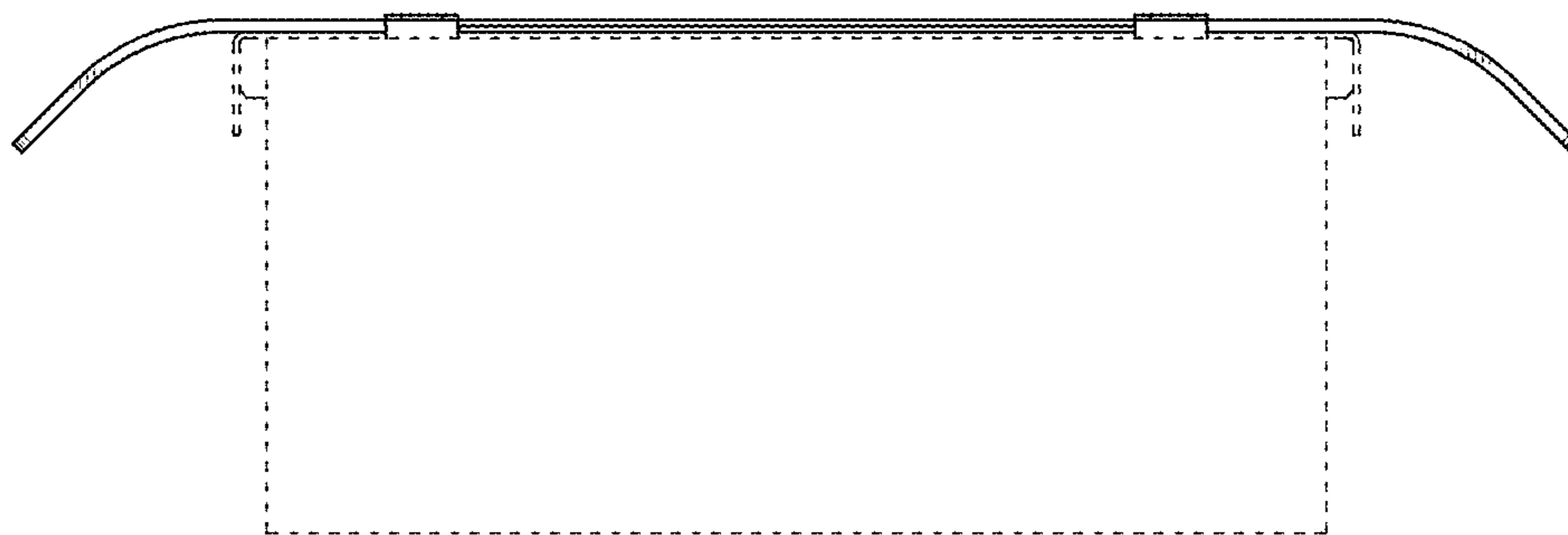

FIG. 7