



US00D901627S

(12) **United States Design Patent**  
**Wu et al.**

(10) **Patent No.:** **US D901,627 S**

(45) **Date of Patent:** **\*\* Nov. 10, 2020**

(54) **SHOWER HEAD**

(71) Applicant: **Purity (Xiamen) Sanitary Ware Co., Ltd.**, Xiamen (CN)

(72) Inventors: **James Wu**, Taichung (TW); **Alex Wu**, Taichung (TW); **Ce-Wen Yang**, Xiamen (CN)

(73) Assignee: **PURITY (XIAMEN) SANITARY WARE CO., LTD.**, Xiamen (CN)

(\*\*) Term: **15 Years**

(21) Appl. No.: **29/673,337**

(22) Filed: **Dec. 13, 2018**

(51) **LOC (12) Cl.** ..... **23-01**

(52) **U.S. Cl.**  
USPC ..... **D23/213; D23/223**

(58) **Field of Classification Search**  
USPC ..... D23/213, 214, 215, 223, 224, 226, 229, D23/230  
CPC ..... A61H 9/0021; A61H 33/00; B05B 1/00; B05B 1/14; B05B 1/185; B05B 1/08; B05B 1/02; B05B 1/26; B05B 12/002; B05B 1/18; B05B 9/01  
See application file for complete search history.

(56) **References Cited**

**U.S. PATENT DOCUMENTS**

6,537,455	B2 *	3/2003	Farley	.....	C02F 1/003 210/251
D559,945	S *	1/2008	Patterson	.....	D23/213
D564,621	S *	3/2008	Lammel	.....	D23/223
D578,604	S *	10/2008	Wu	.....	D23/223
D581,014	S *	11/2008	Quinn	.....	D23/223
D610,651	S *	2/2010	Wu	.....	D23/223
7,866,576	B1 *	1/2011	Farley	.....	E03C 1/0409 239/553
D634,810	S *	3/2011	Yoo	.....	D23/213
D659,796	S *	5/2012	Farley	.....	D23/223

D659,797	S *	5/2012	Farley	.....	D23/223
D666,010	S *	8/2012	Farley	.....	D6/309
D680,619	S *	4/2013	Zhadanov	.....	D23/223
D681,776	S *	5/2013	Cutler	.....	D23/223
D744,065	S *	11/2015	Peterson	.....	D23/223
D744,611	S *	12/2015	Quinn	.....	D23/223
D755,346	S *	5/2016	Yan	.....	D23/223
9,404,243	B2 *	8/2016	Cacka	.....	B05B 1/1654
D779,039	S *	2/2017	Hanna	.....	D23/223
9,764,339	B2 *	9/2017	Yu	.....	B05B 1/18
D810,861	S *	2/2018	Weaver	.....	D23/213
D820,949	S *	6/2018	Reinecker	.....	D23/213
D842,967	S *	3/2019	Farley	.....	D23/213
10,234,054	B1 *	3/2019	Yang	.....	F16K 31/52408

(Continued)

**OTHER PUBLICATIONS**

<https://www.amazon.co.uk/Chrome-Shower-Head-Oval-Shape/dp/B01EJHCSGS> (Year: 2016).\*

*Primary Examiner* — Manpreet S Matharu

*Assistant Examiner* — Keith J Wilson

(74) *Attorney, Agent, or Firm* — Birch, Stewart, Kolasch & Birch, LLP

(57) **CLAIM**

The ornamental design for a shower head, as shown and described.

**DESCRIPTION**

FIG. 1 is a first perspective view of a shower head showing our new design;

FIG. 2 is a front view of FIG. 1;

FIG. 3 is a rear view of FIG. 1;

FIG. 4 is a left side view of FIG. 1;

FIG. 5 is a right side view of FIG. 1;

FIG. 6 is a top view of FIG. 1; and,

FIG. 7 is a bottom view of FIG. 1.

The broken lines shown represent portions of the shower head and form no part of the claimed design.

**1 Claim, 7 Drawing Sheets**

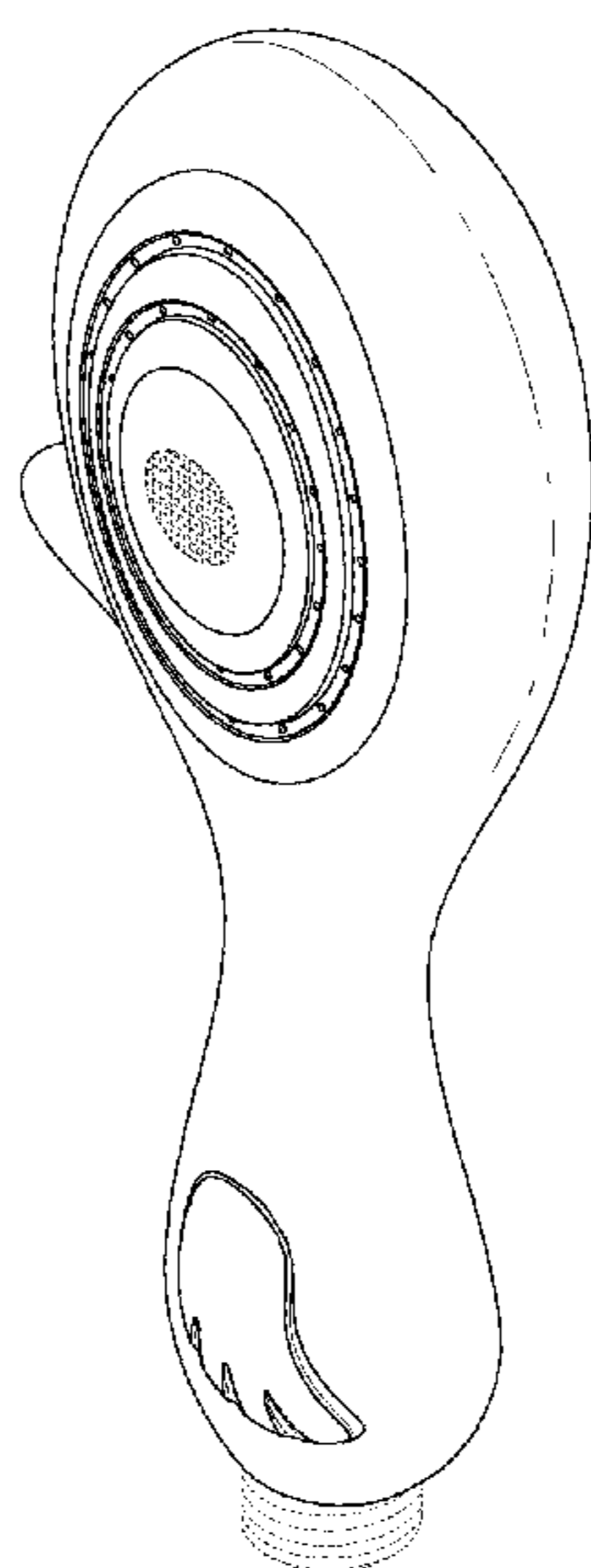

(56)

**References Cited**

U.S. PATENT DOCUMENTS

D857,842 S \* 8/2019 Yu ..... D23/213  
2012/0031511 A1\* 2/2012 Farley ..... E03C 1/0408  
137/544  
2019/0091715 A1\* 3/2019 Mercado ..... B05B 1/185

\* cited by examiner

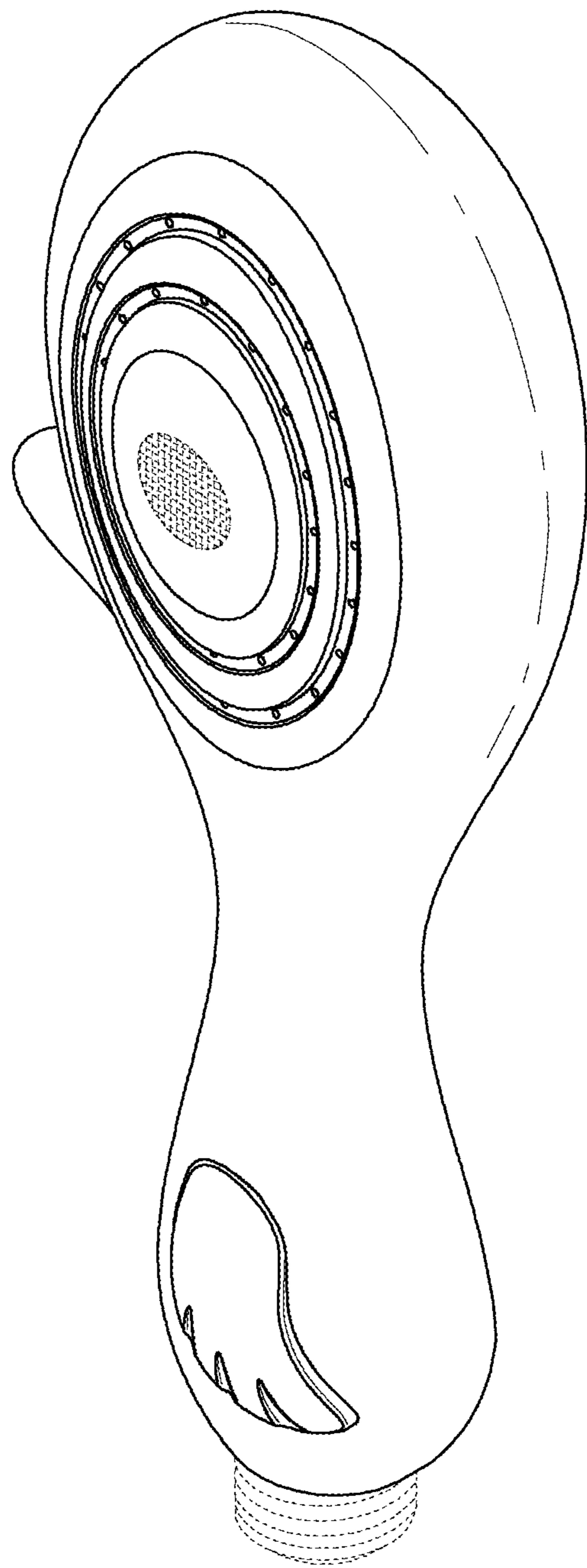

FIG.1

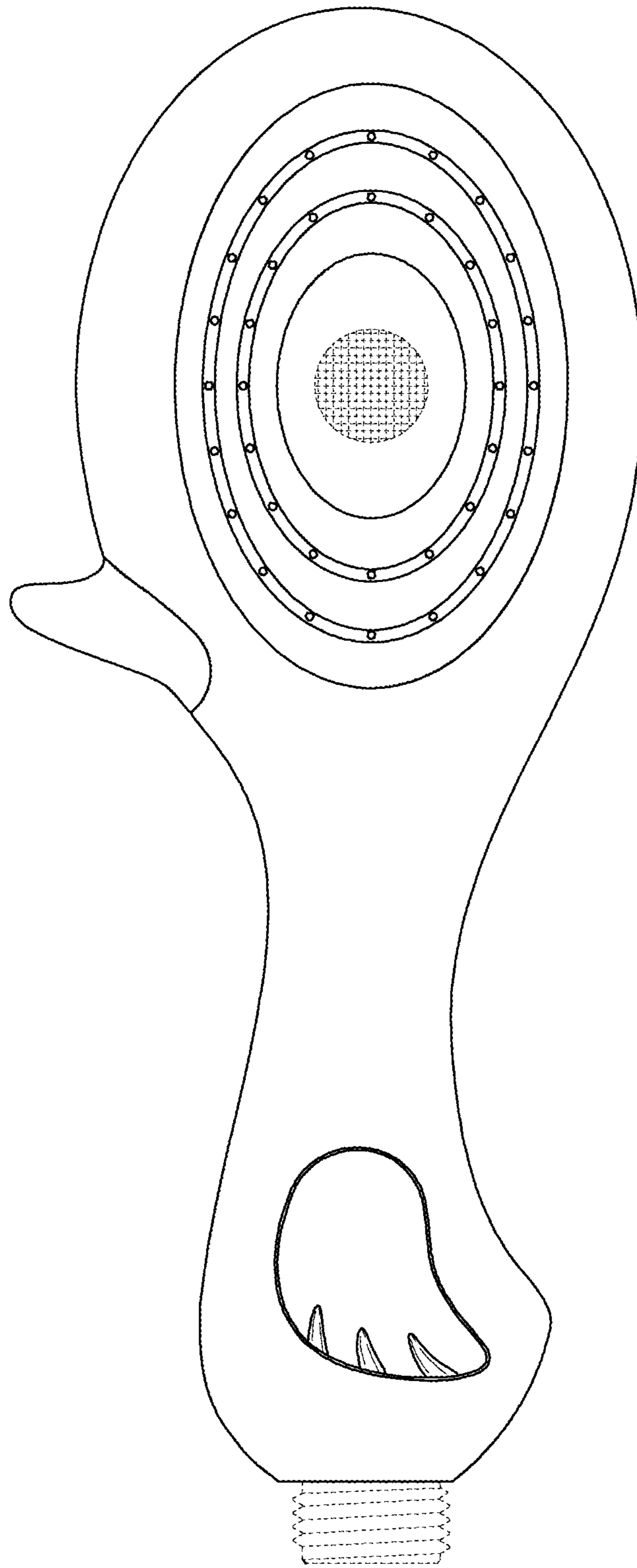

FIG.2

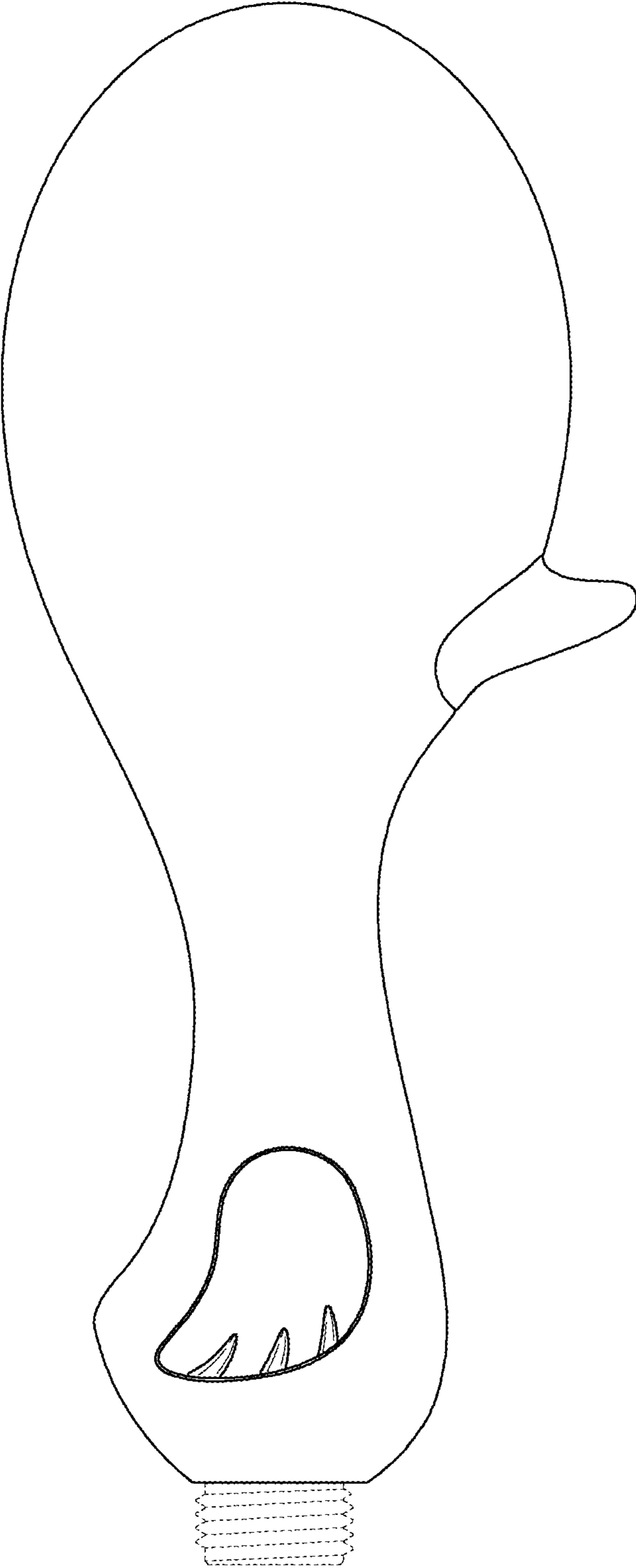

FIG.3

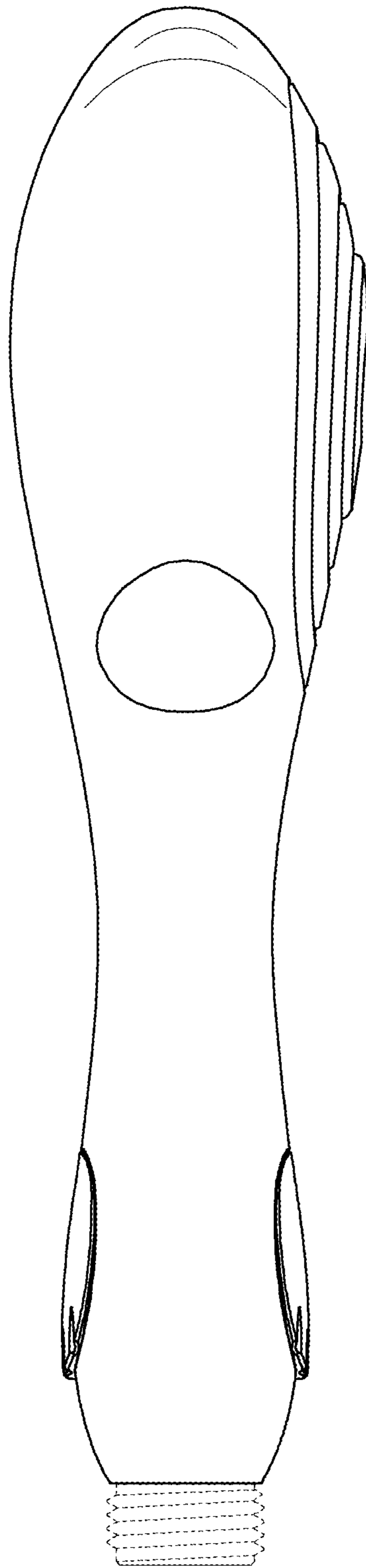

FIG.4

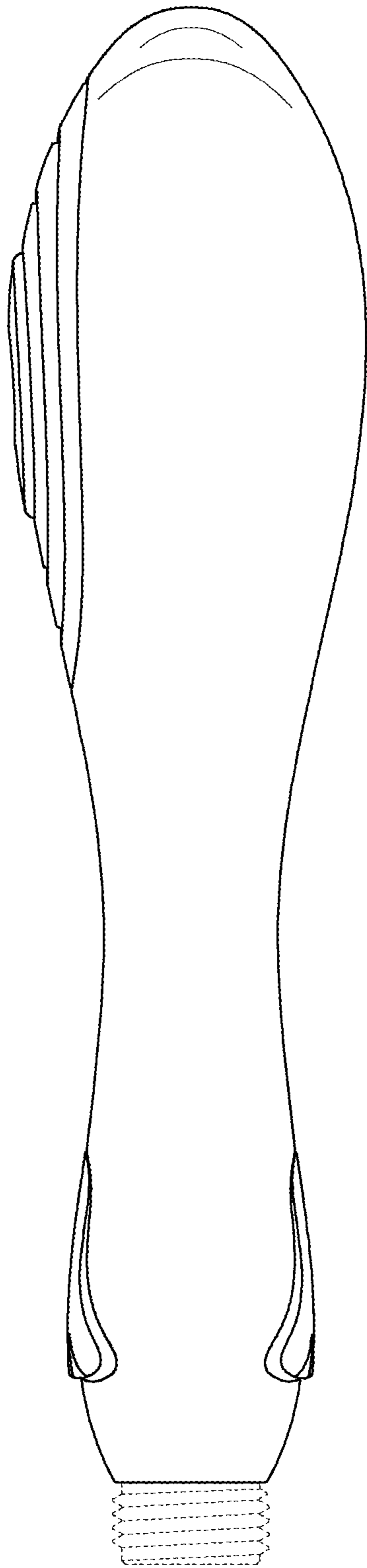

FIG.5

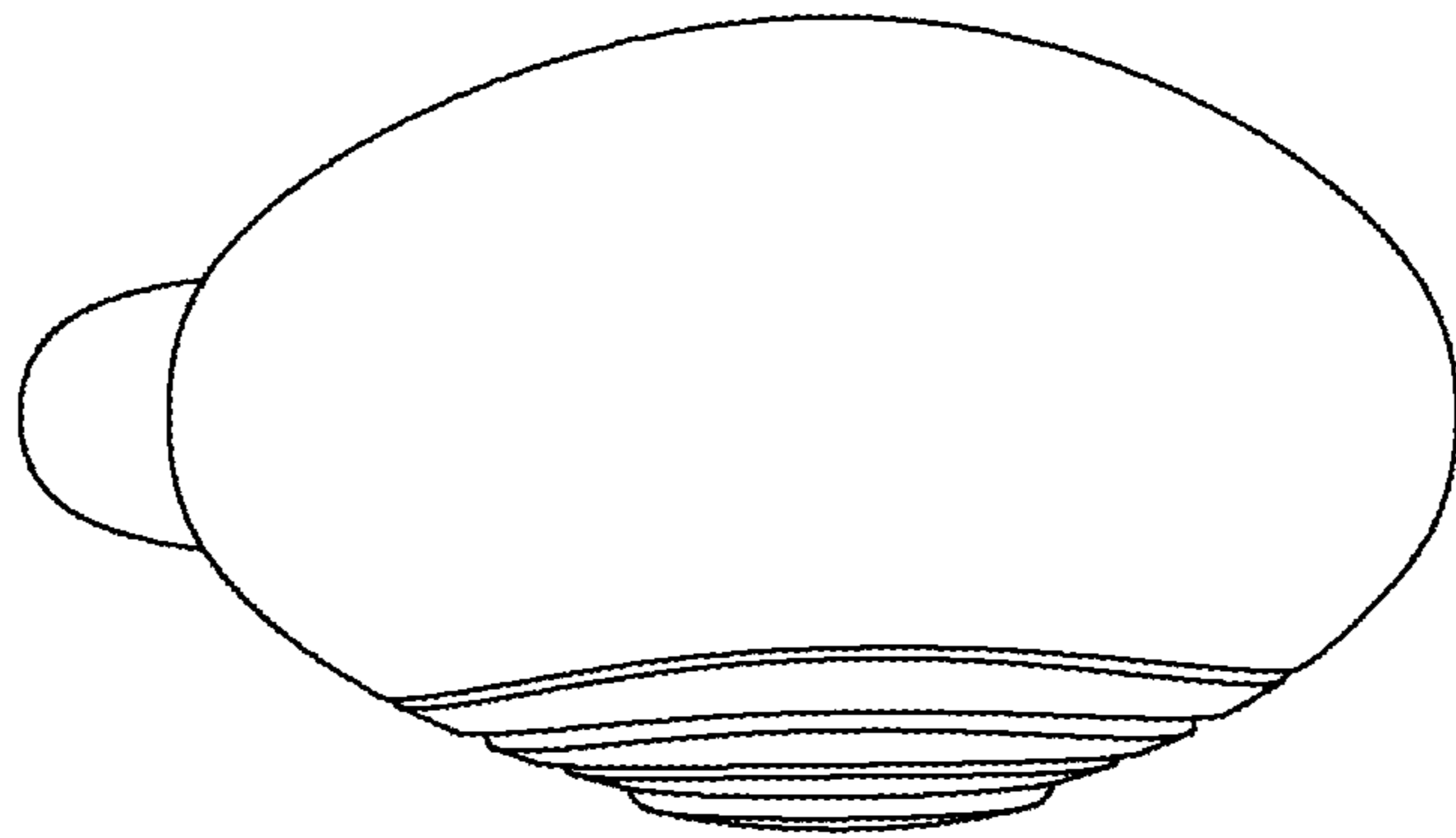
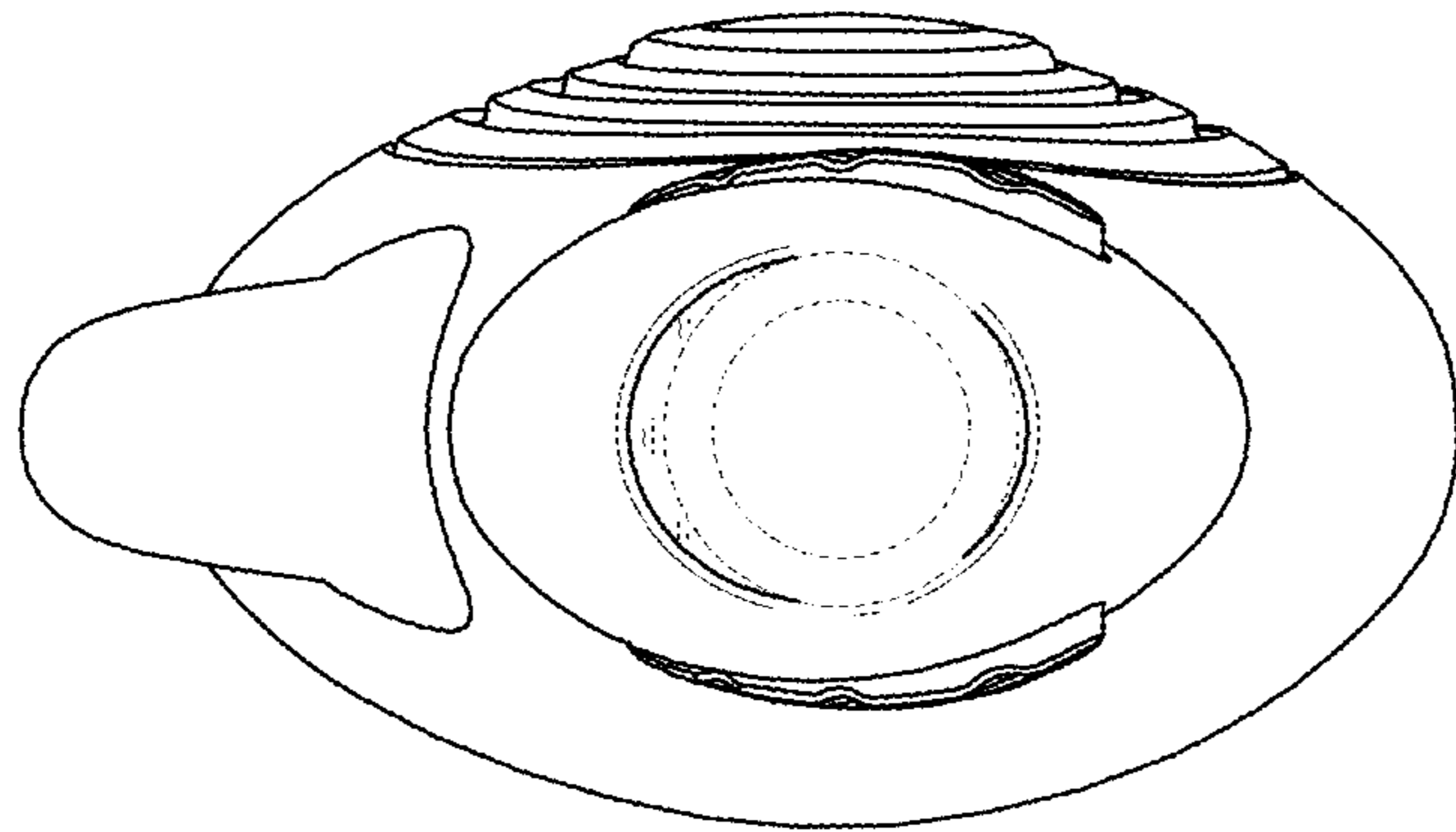

FIG.6





**FIG.7**