



US00D901569S

(12) **United States Design Patent**
Sugimoto et al.

(10) **Patent No.:** **US D901,569 S**
(45) **Date of Patent:** **** Nov. 10, 2020**

(54) **MIRROR FOR OPTICAL INSTRUMENTS**

(71) Applicant: **HAMAMATSU PHOTONICS K.K.**,
Hamamatsu-shi (JP)

(72) Inventors: **Tatsuya Sugimoto**, Hamamatsu (JP);
Tomofumi Suzuki, Hamamatsu (JP);
Kyosuke Kotani, Hamamatsu (JP)

(73) Assignee: **HAMAMATSU PHOTONICS K.K.**,
Hamamatsu-shi (JP)

(**) Term: **15 Years**

(21) Appl. No.: **29/667,090**

(22) Filed: **Oct. 18, 2018**

(30) **Foreign Application Priority Data**

Apr. 27, 2018 (JP) 2018-009456

(51) **LOC (12) Cl.** **16-06**

(52) **U.S. Cl.**
USPC **D16/136**

(58) **Field of Classification Search**
USPC D16/130-136, 222, 216; D24/216
(Continued)

(56) **References Cited**

U.S. PATENT DOCUMENTS

7,470,893 B2 * 12/2008 Suzuki H01L 27/14634
250/208.1
7,522,643 B2 * 4/2009 Miyajima H01S 5/02423
372/34

(Continued)

Primary Examiner — Mark A Goodwin

Assistant Examiner — Benjamin M Weeks

(74) *Attorney, Agent, or Firm* — Faegre Drinker Biddle &
Reath LLP

(57) **CLAIM**

The ornamental design for a mirror for optical instruments,
as shown and described.

DESCRIPTION

FIG. 1 is a perspective view of a first embodiment of a mirror for optical instruments showing our new design; FIG. 2 is a front view thereof; FIG. 3 is a rear view thereof; FIG. 4 is a top plan view thereof; FIG. 5 is a bottom view thereof; FIG. 6 is a right side view thereof; FIG. 7 is a left side view thereof; FIG. 8 is a sectional view taken along the line 8-8 in FIG. 4;

FIG. 9 is an enlarged view showing portion of FIG. 4 defined by the lines 901-901 and 902-902;

FIG. 10 is an enlarged view showing portion of FIG. 1 defined by the lines 1001-1001 and 1002-1002;

FIG. 11 is an enlarged view showing portion of FIG. 8 defined by the lines 11-11;

FIG. 12 is a perspective view of a second embodiment of a mirror for optical instruments showing our new design;

FIG. 13 is a front view thereof; FIG. 14 is a rear view thereof;

FIG. 15 is a top plan view thereof; FIG. 16 is a bottom view thereof;

FIG. 17 is a right side view thereof; FIG. 18 is a left side view thereof;

FIG. 19 is a sectional view taken along the line 19-19 in FIG. 15;

FIG. 20 is an enlarged view showing portion of FIG. 15 defined by the lines 2001-2001 and 2002-2002;

FIG. 21 is an enlarged view showing portion of FIG. 12 defined by the lines 2101-2101 and 2102-2102;

FIG. 22 is an enlarged view showing portion of FIG. 19 defined by the lines 22-22;

FIG. 23 is a perspective view of a third embodiment of a mirror for optical instruments showing our new design;

FIG. 24 is a front view thereof; FIG. 25 is a rear view thereof;

FIG. 26 is a top plan view thereof; FIG. 27 is a bottom view thereof;

(Continued)

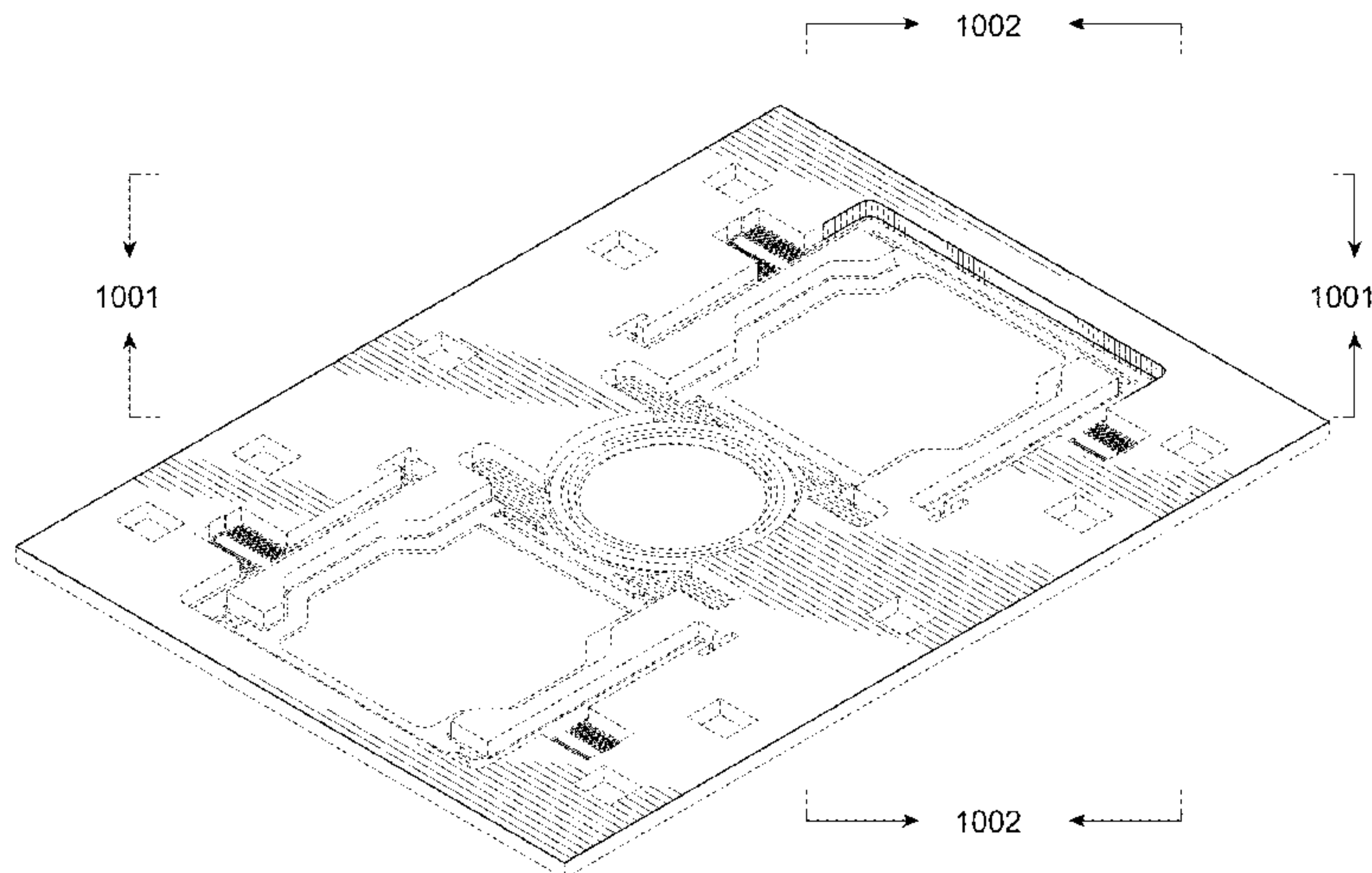

FIG. 28 is a right side view thereof;
 FIG. 29 is a left side view thereof;
 FIG. 30 is a sectional view taken along the line 30-30 in FIG. 26;
 FIG. 31 is an enlarged view showing portion of FIG. 26 defined by the lines 3101-3101 and 3102-3102;
 FIG. 32 is an enlarged view showing portion of FIG. 23 defined by the lines 3201-3201 and 3202-3202; and,
 FIG. 33 is an enlarged view showing portion of FIG. 30 defined by the lines 33-33.
 The features shown in broken lines depict environmental subject matter only and form no part of the claimed design. The alternate long and short dash lines are merely the boundary lines between the claimed parts and the non-claimed parts.

1 Claim, 33 Drawing Sheets

(58) Field of Classification Search

CPC G01J 3/18; G01J 3/0256-0259; G01J 3/02;
 G01J 3/0262; G02B 6/12007; G02B
 6/29325; G02B 6/292328

See application file for complete search history.

(56)

References Cited

U.S. PATENT DOCUMENTS

8,035,814	B2 *	10/2011	Shibayama	G01J 3/02 356/328
8,045,157	B2 *	10/2011	Shibayama	G01J 3/02 356/328
8,068,223	B2 *	11/2011	Suzuki	G01J 3/02 356/326
8,071,945	B2 *	12/2011	Krishna	G01J 3/02 250/338.4
8,957,358	B2 *	2/2015	Wan	H01L 27/14609 250/208.1
9,075,193	B2 *	7/2015	Shibayama	G01J 3/02
9,766,448	B2 *	9/2017	Takimoto	G02B 26/085
D825,360	S *	8/2018	Ito	D10/81
D825,500	S *	8/2018	Nishio	D13/180
10,090,349	B2 *	10/2018	Wan	H01L 27/14634
D835,800	S *	12/2018	Ito	D24/225
D835,801	S *	12/2018	Ito	D24/225
D851,150	S *	6/2019	Spuhler	D16/131
D866,642	S *	11/2019	Lo	D16/219
D875,151	S *	2/2020	Matthews	D16/130

* cited by examiner

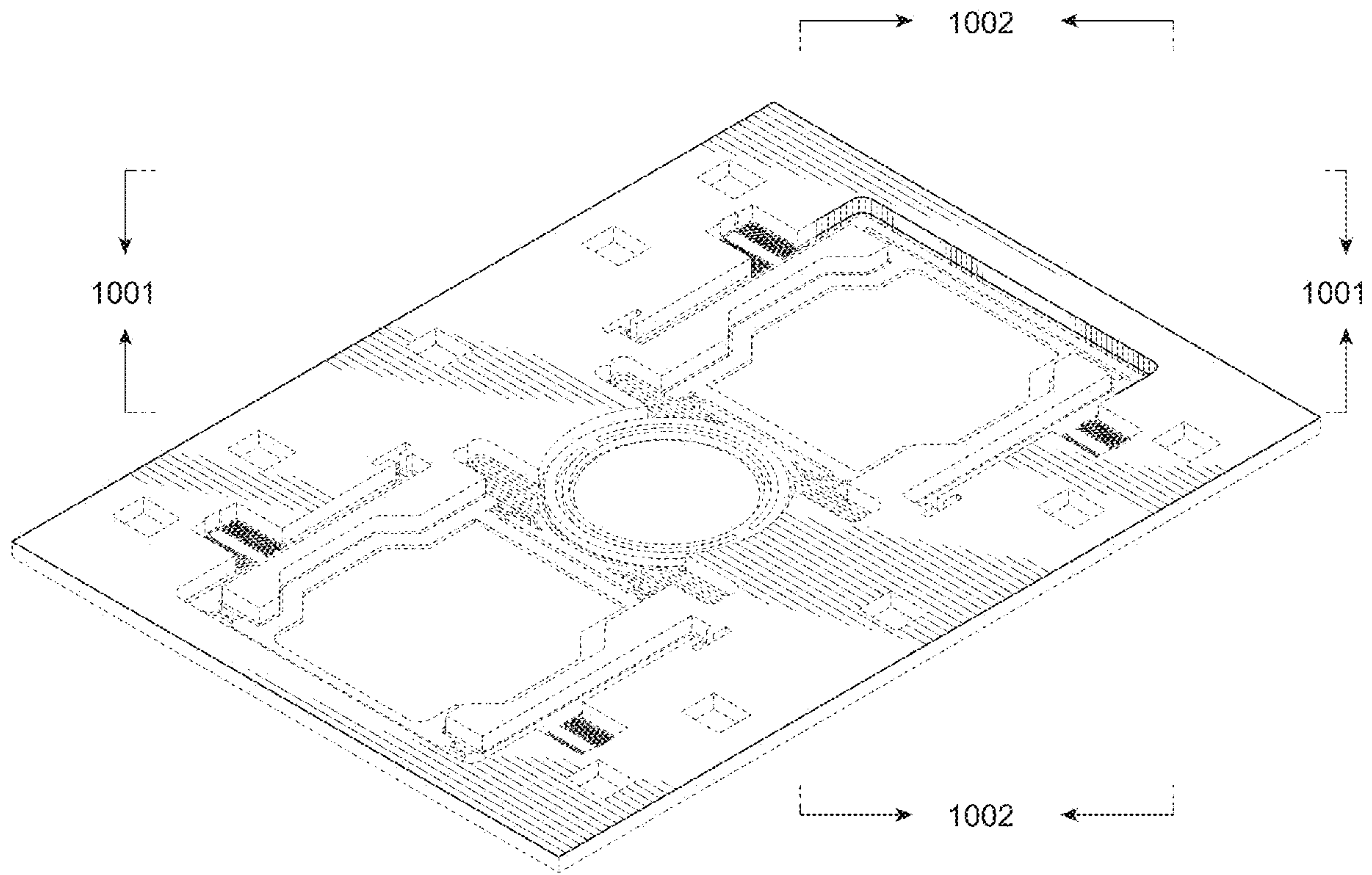

FIG. 1

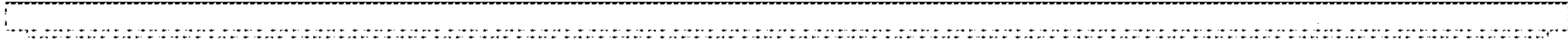

FIG. 2

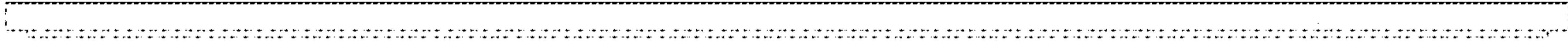

FIG. 3

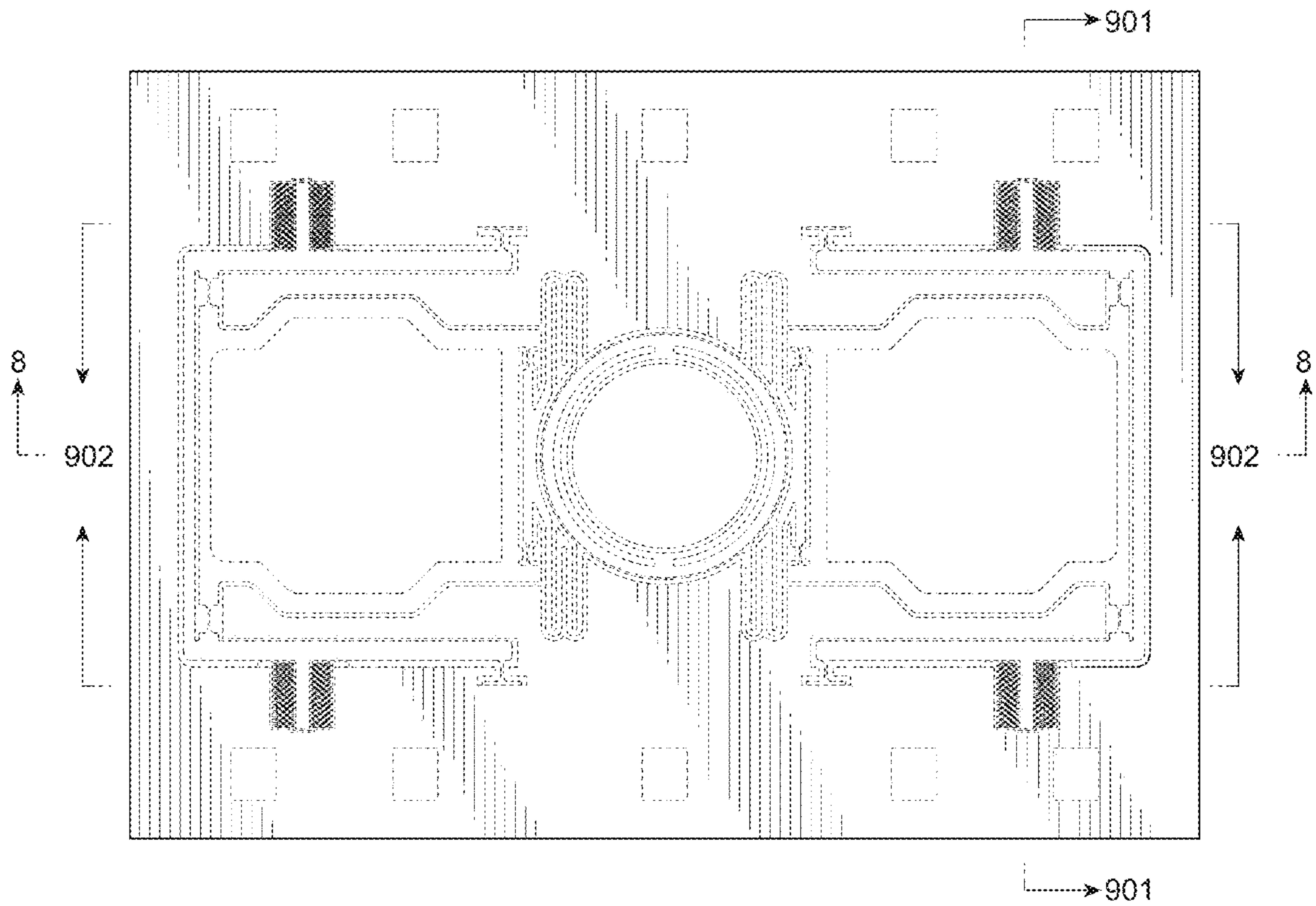

FIG. 4

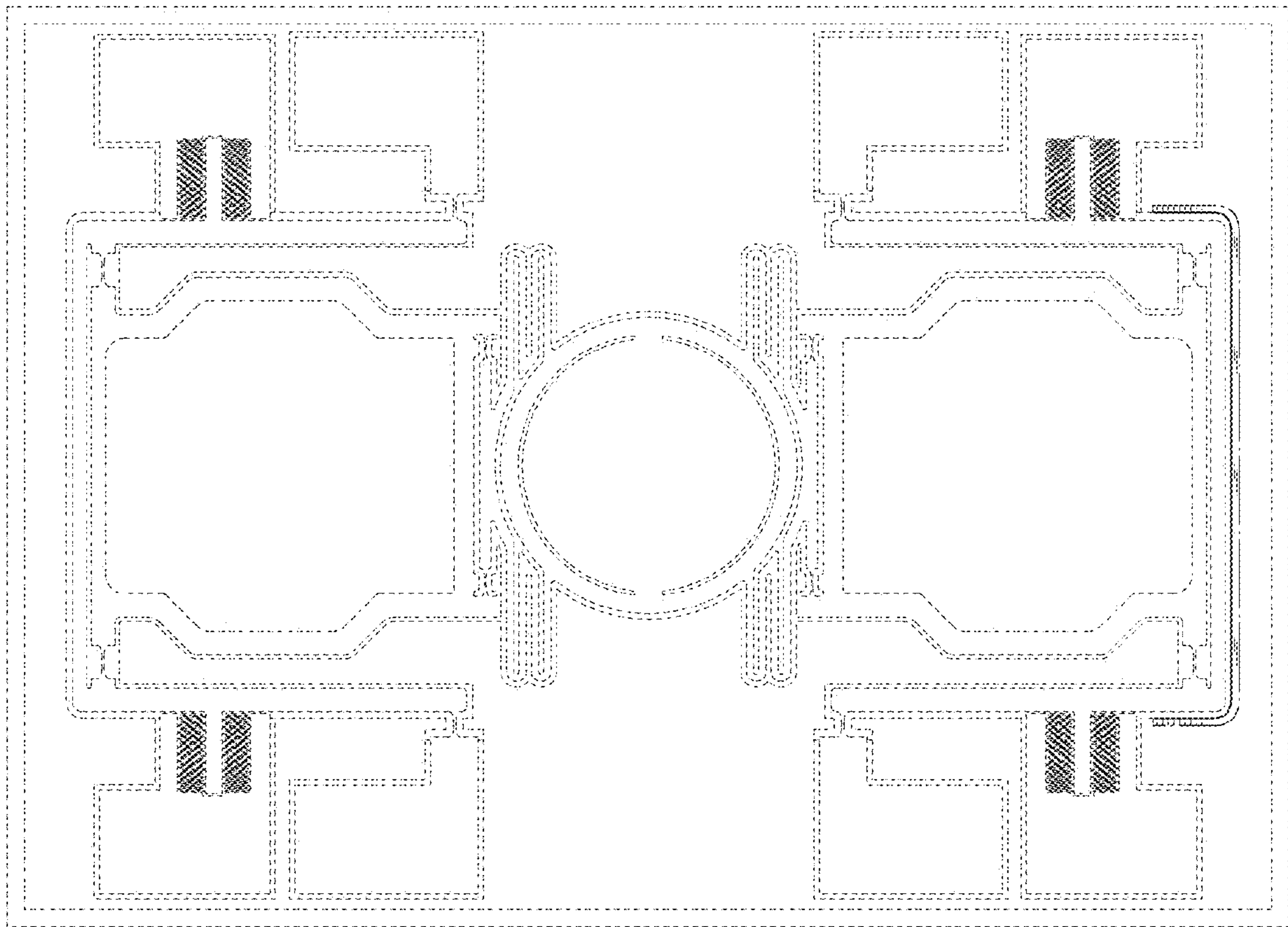

FIG. 5

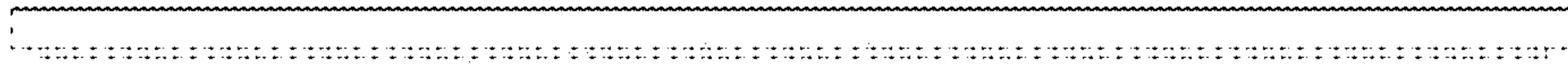

FIG. 6

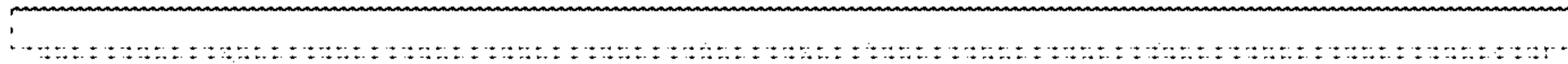

FIG. 7

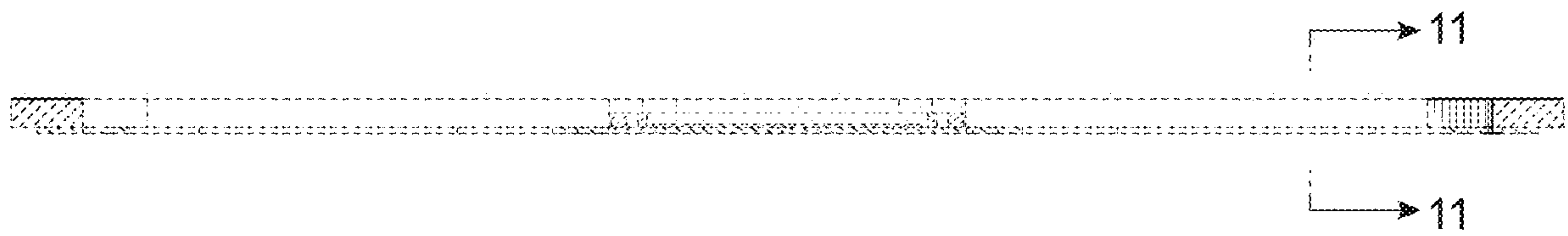

FIG. 8

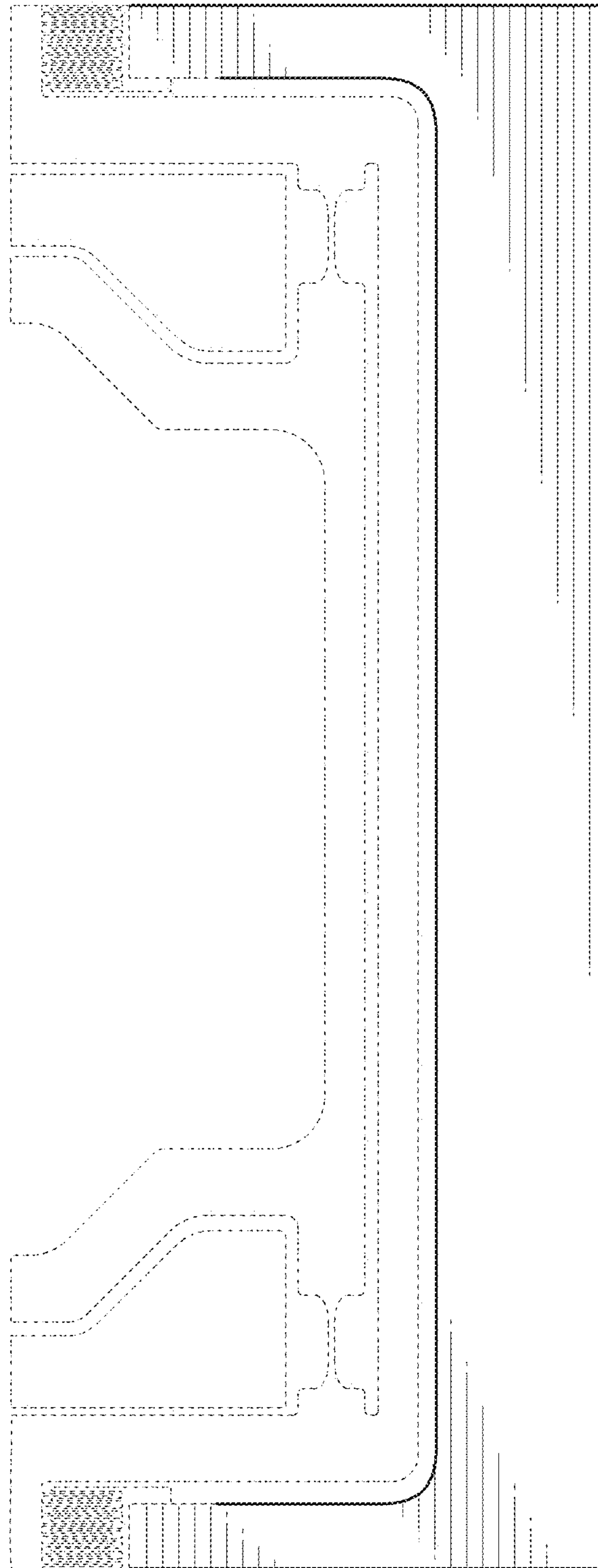

FIG. 9

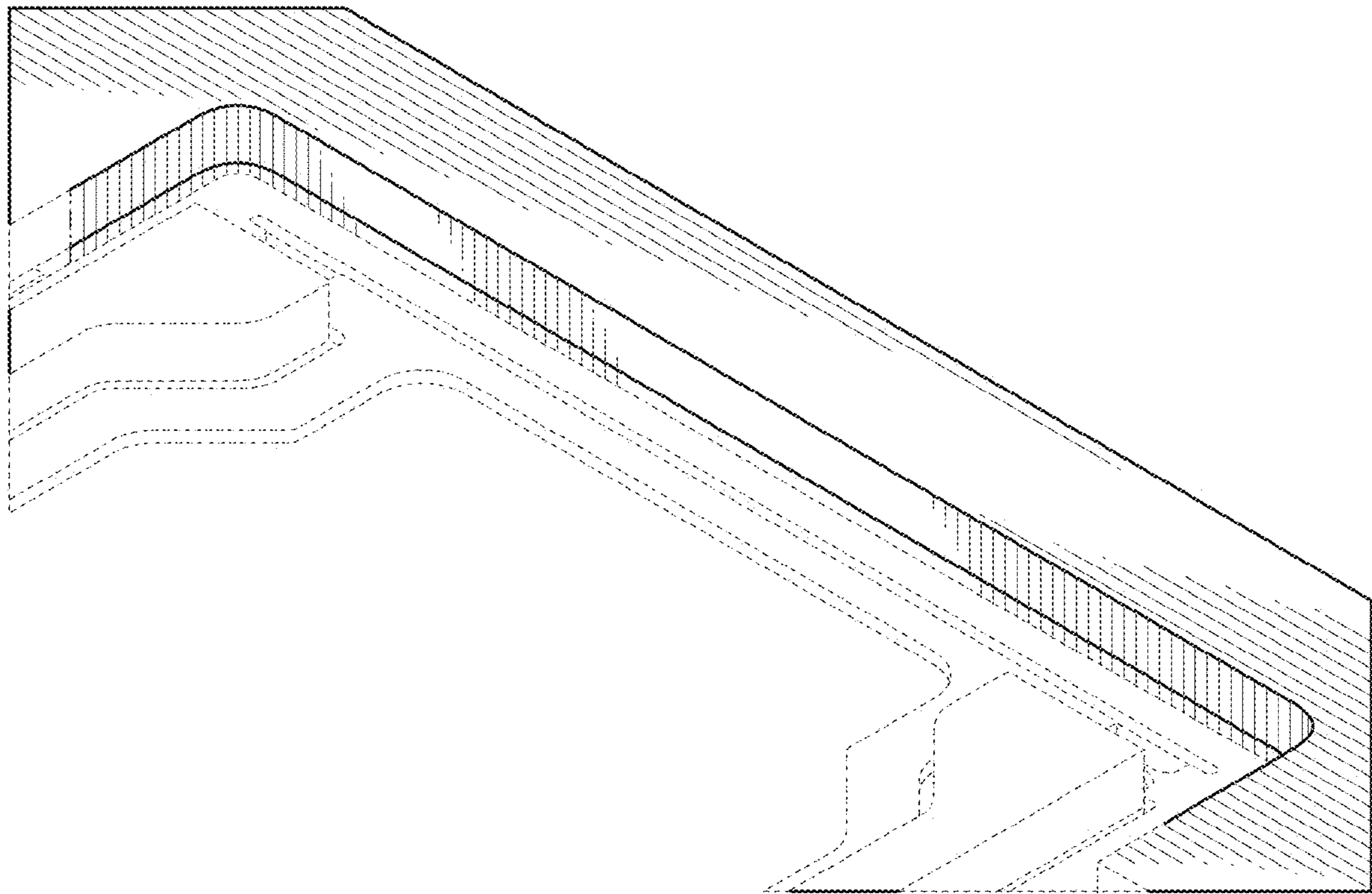

FIG. 10

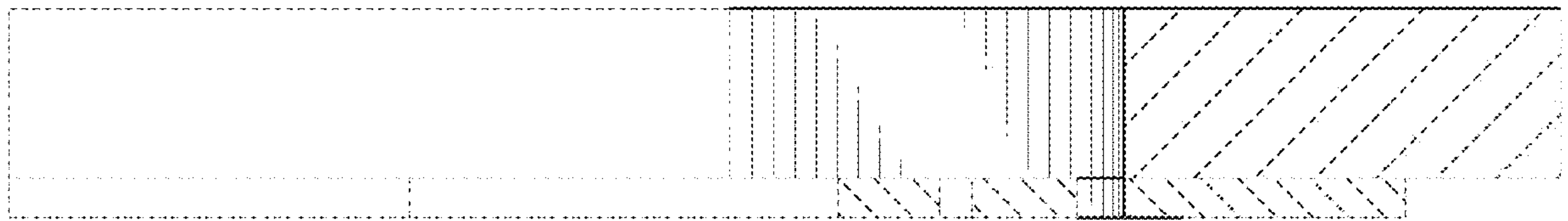

FIG. 11

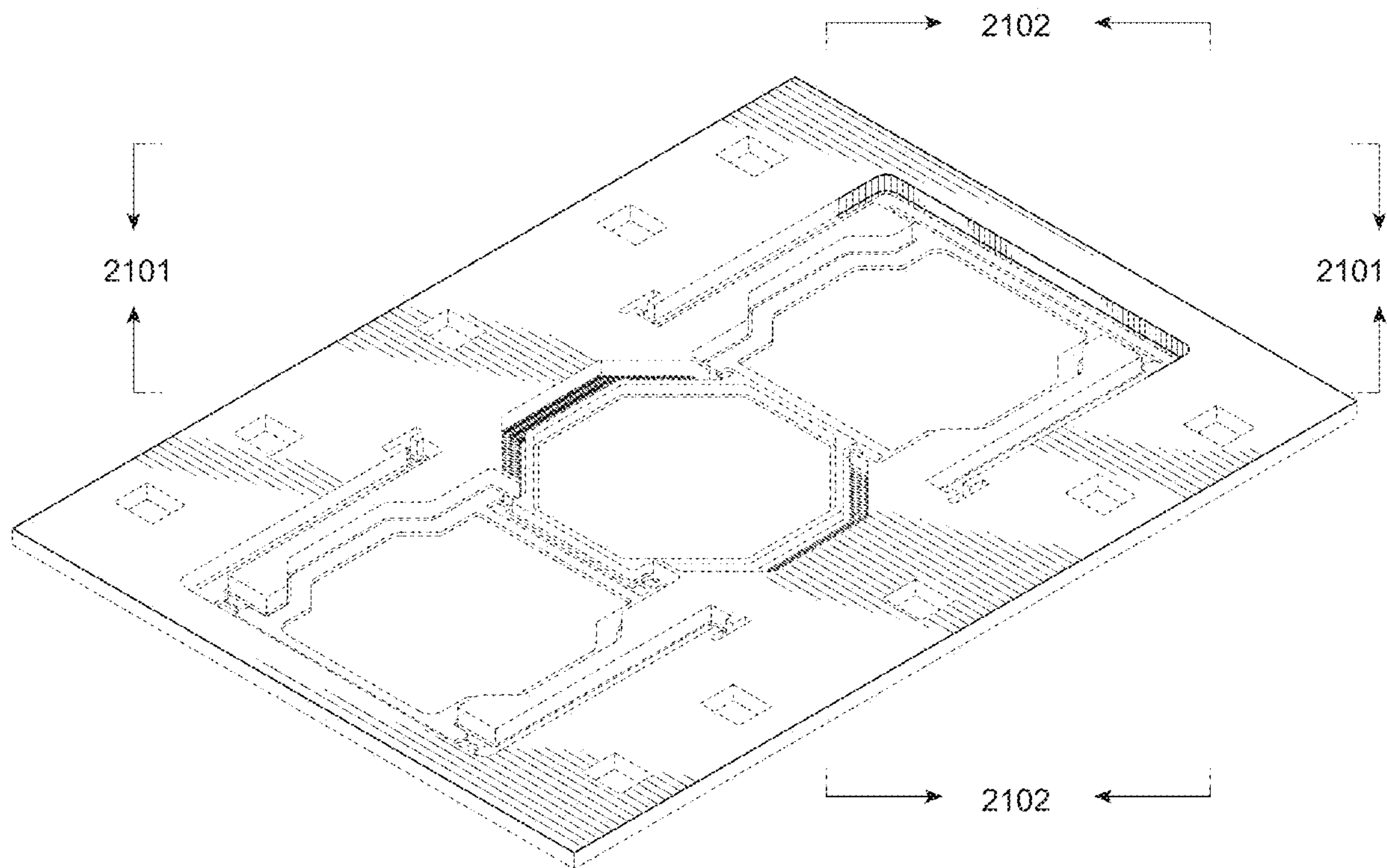

FIG. 12

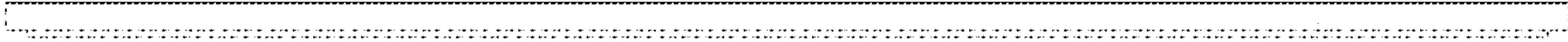

FIG. 13

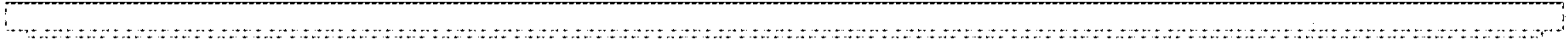

FIG. 14

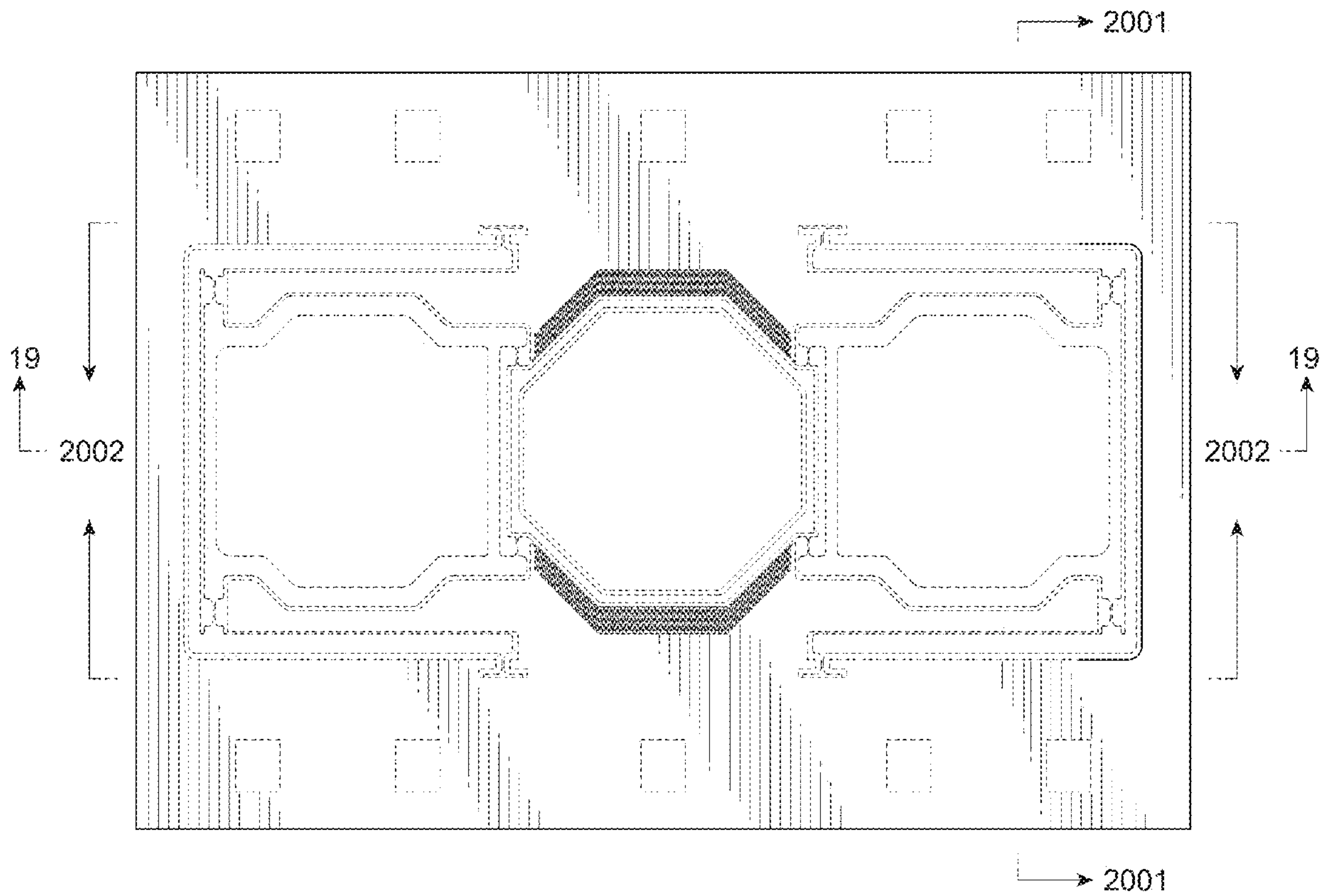

FIG. 15

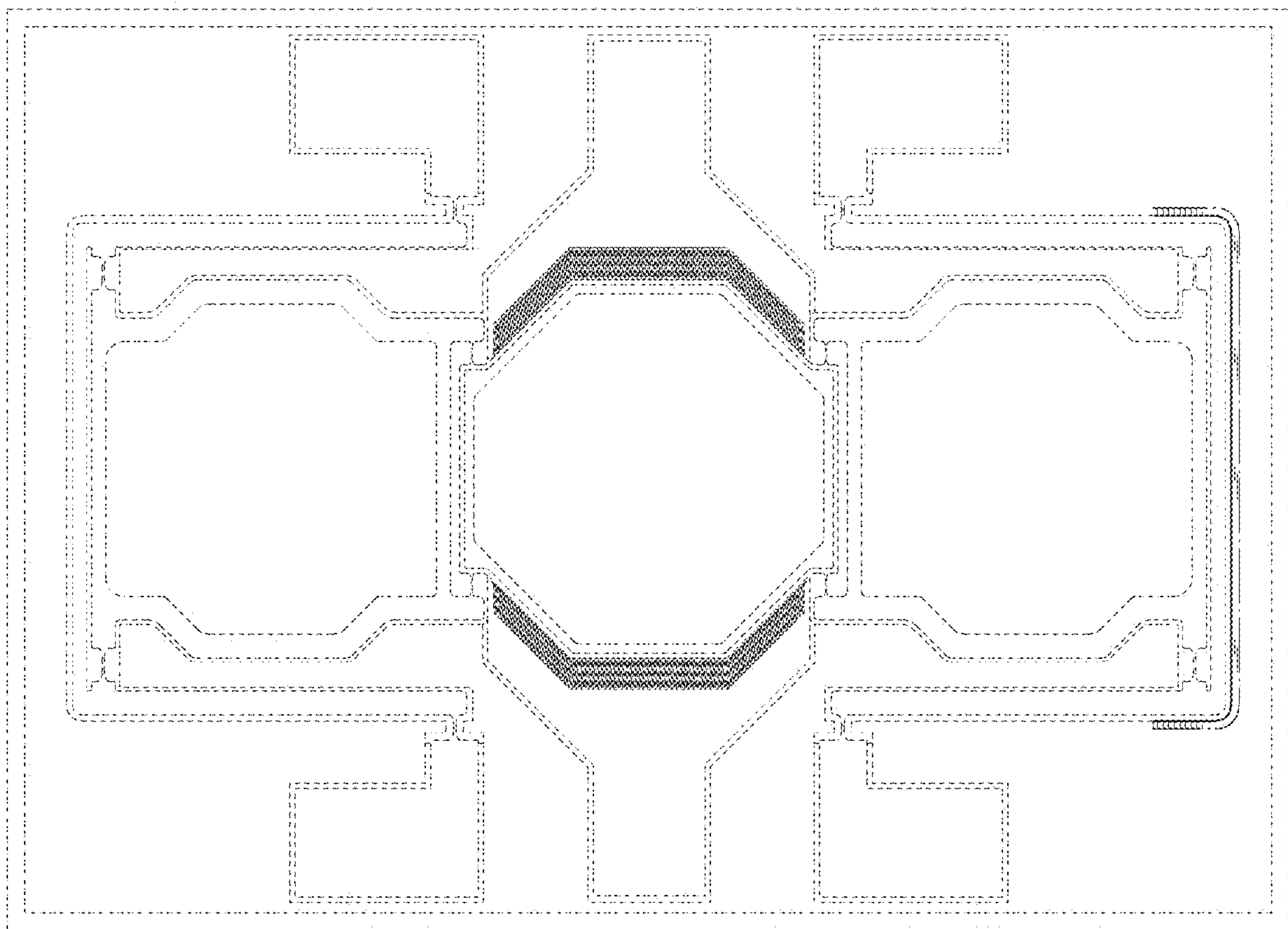

FIG. 16

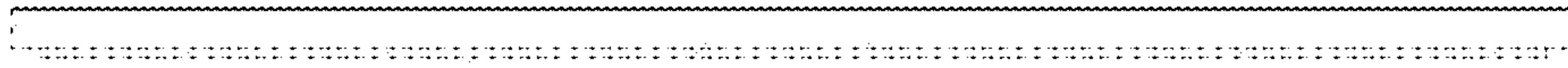

FIG. 17

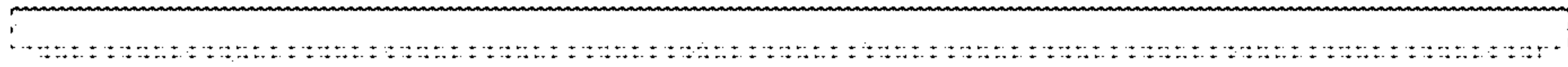

FIG. 18

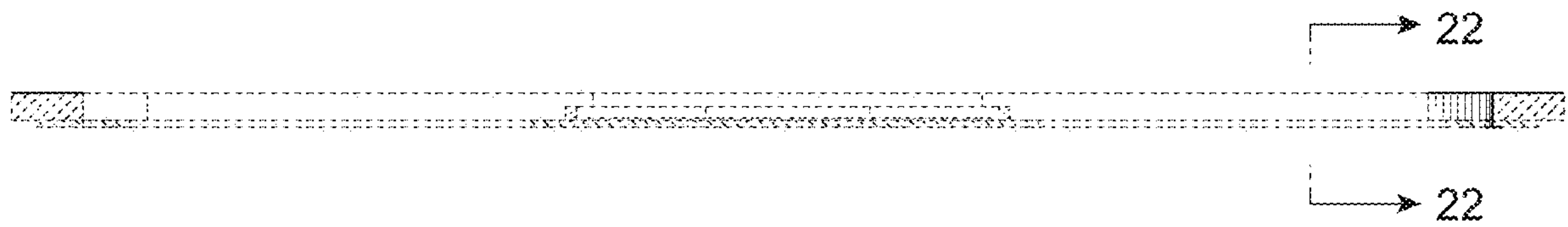

FIG. 19

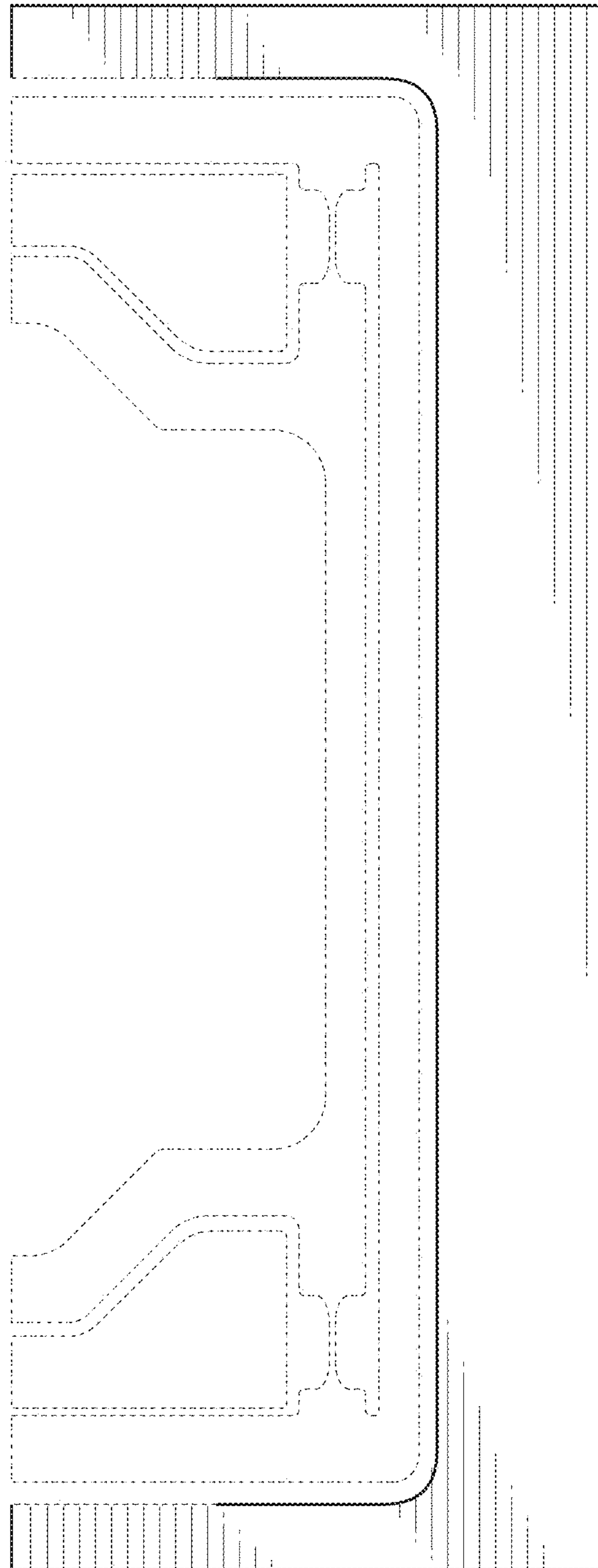

FIG. 20

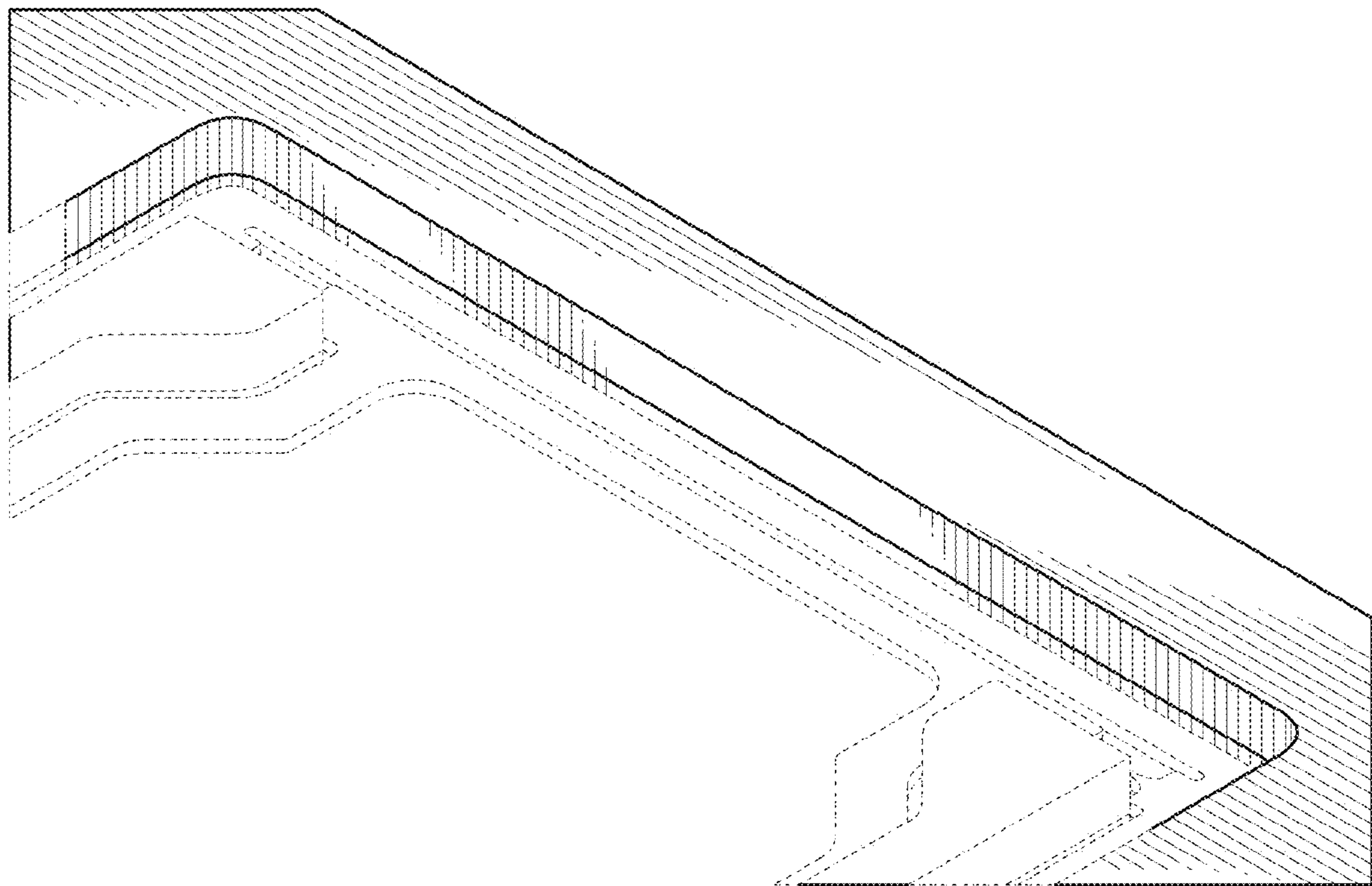

FIG. 21

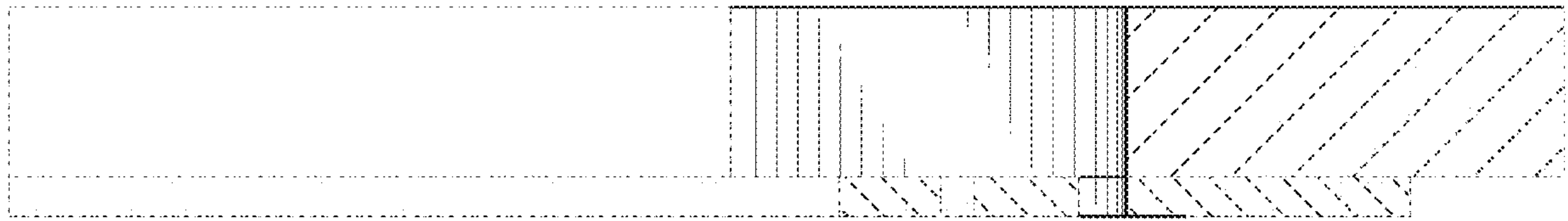

FIG. 22

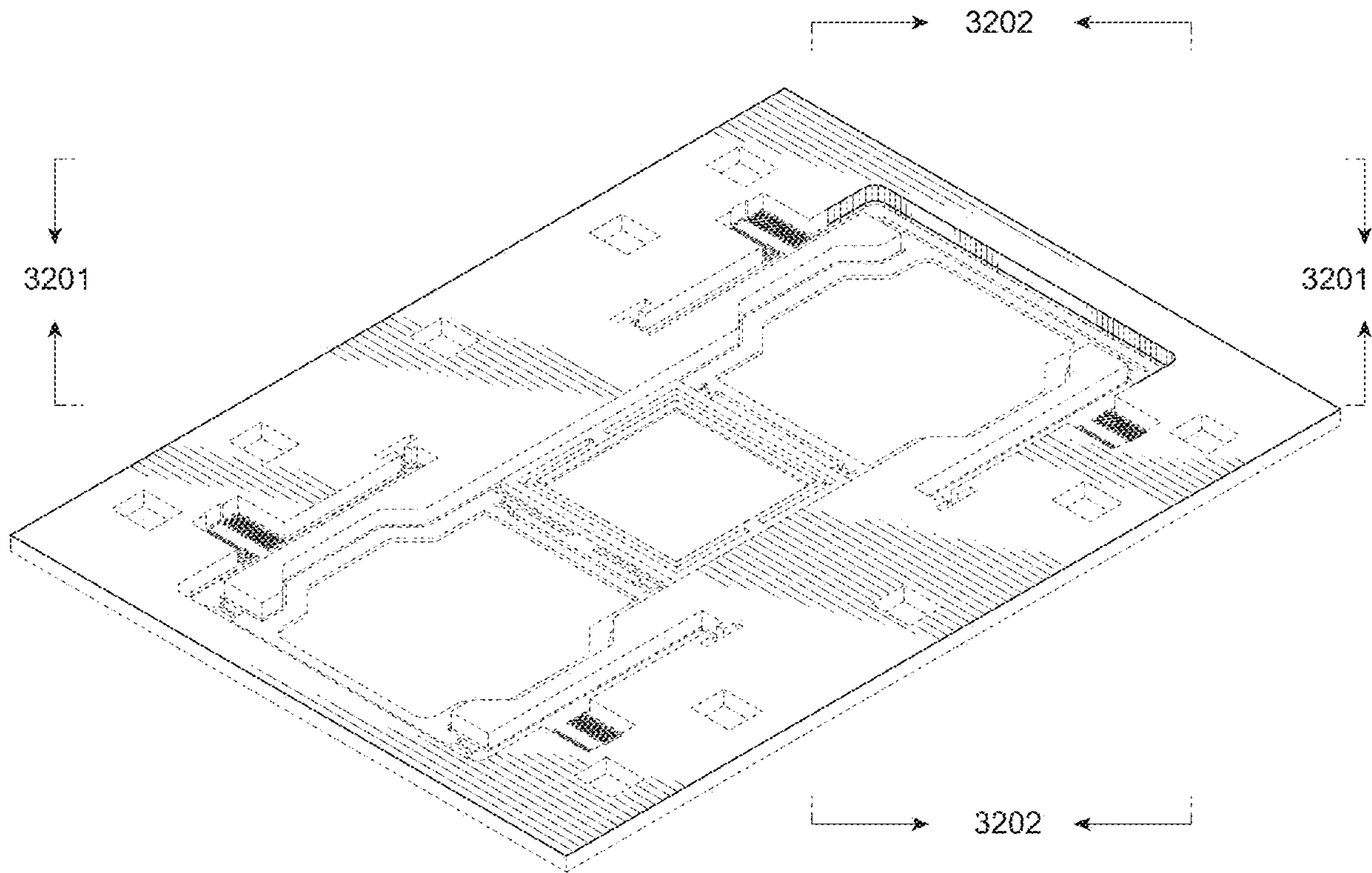

FIG. 23



FIG. 24

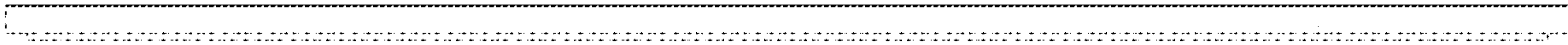

FIG. 25

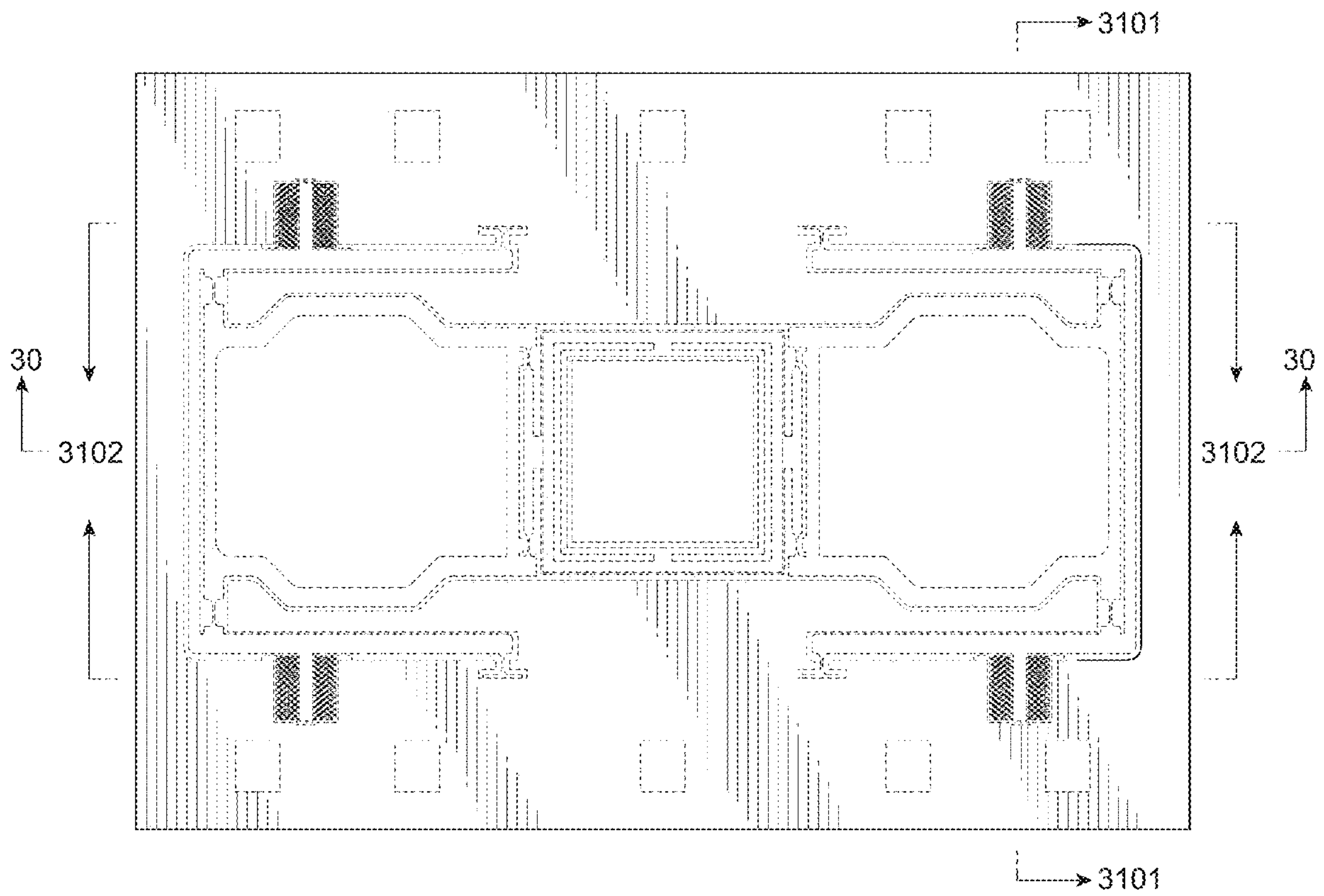

FIG. 26

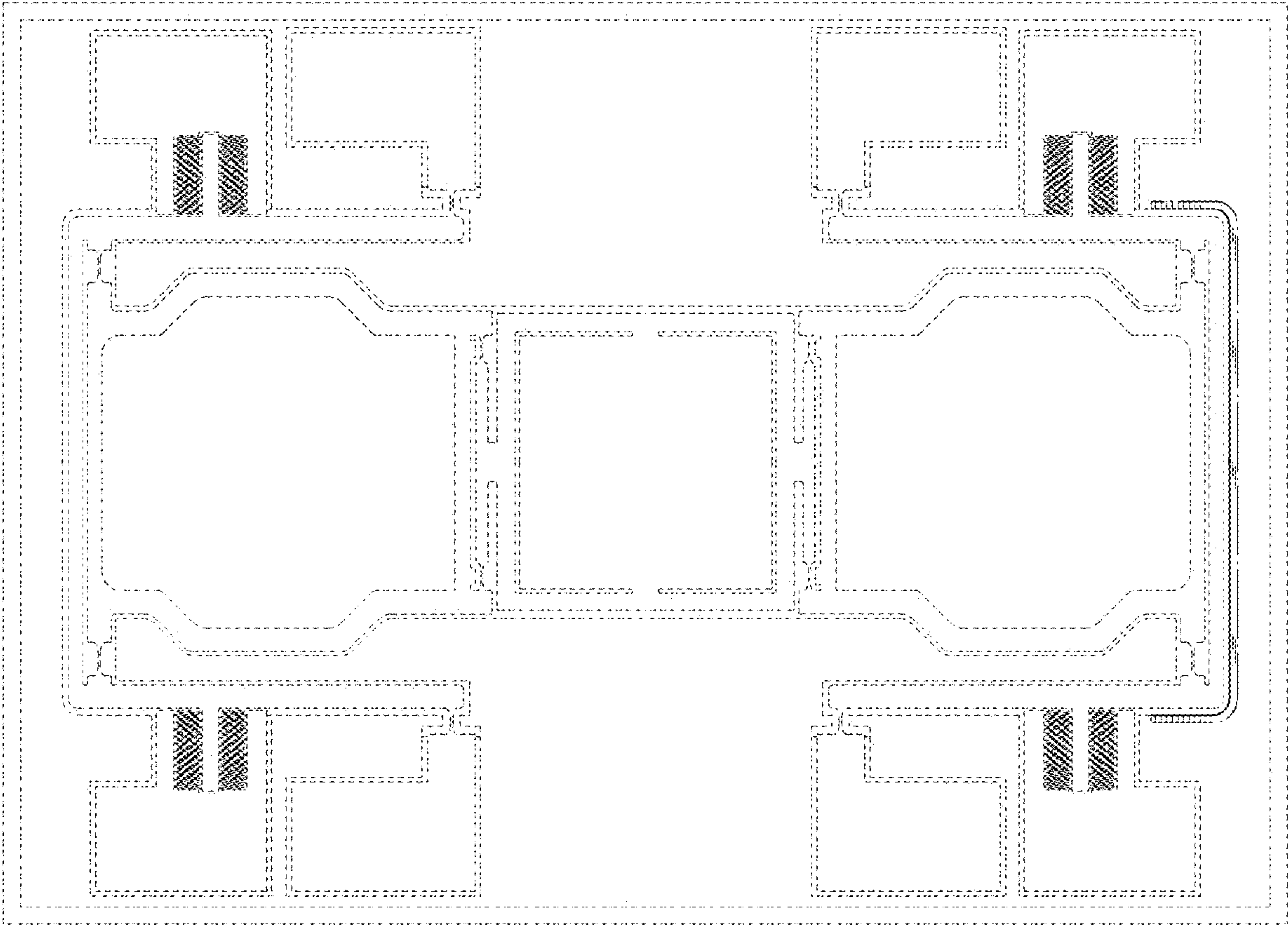

FIG. 27

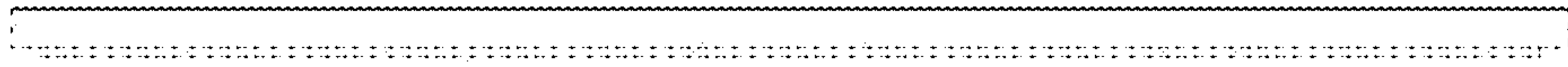

FIG. 28

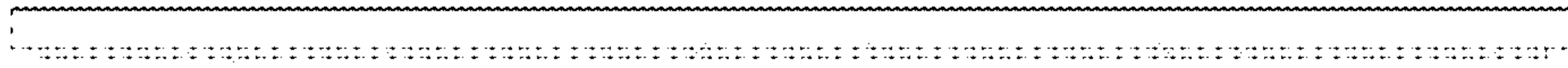

FIG. 29

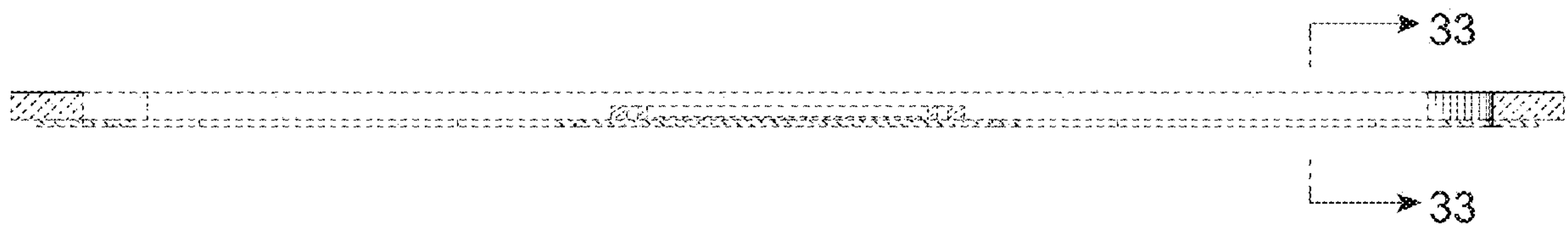

FIG. 30

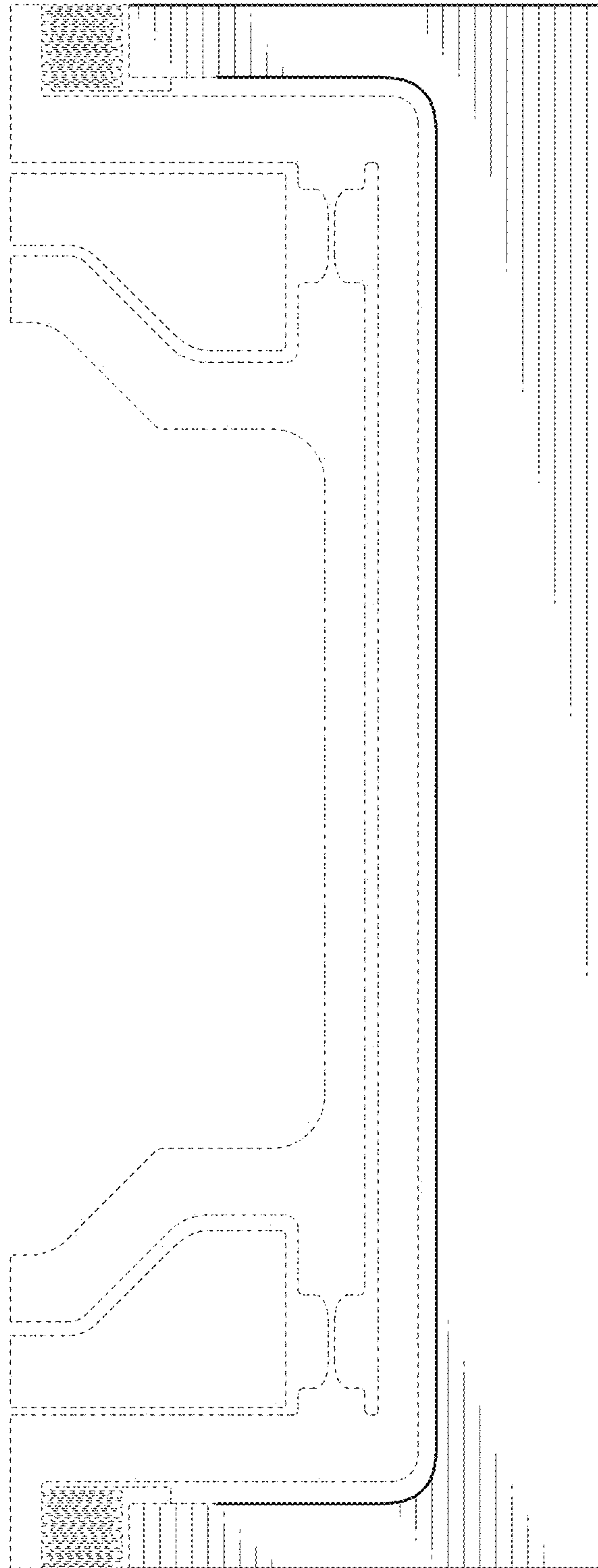

FIG. 31

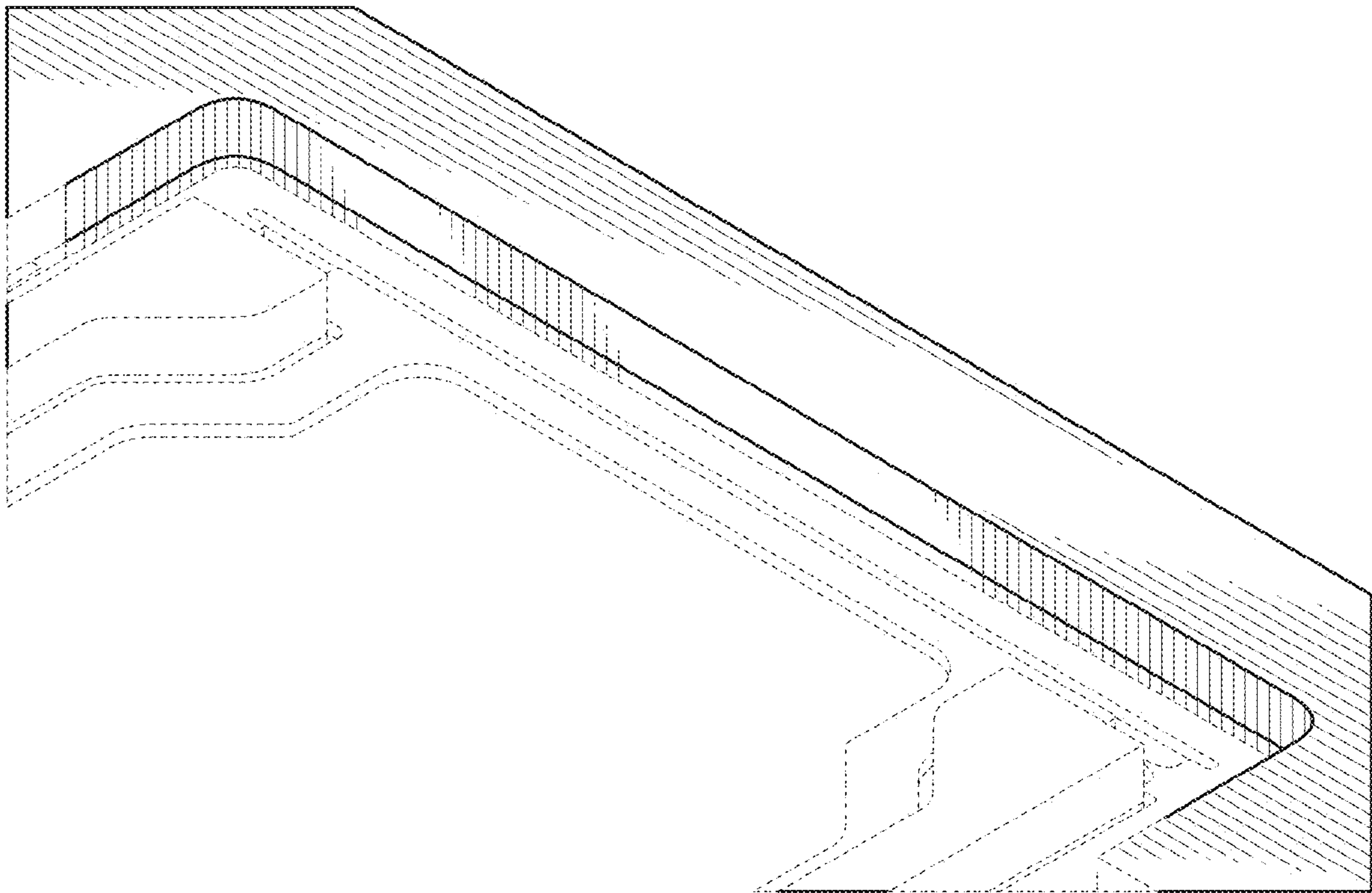

FIG. 32

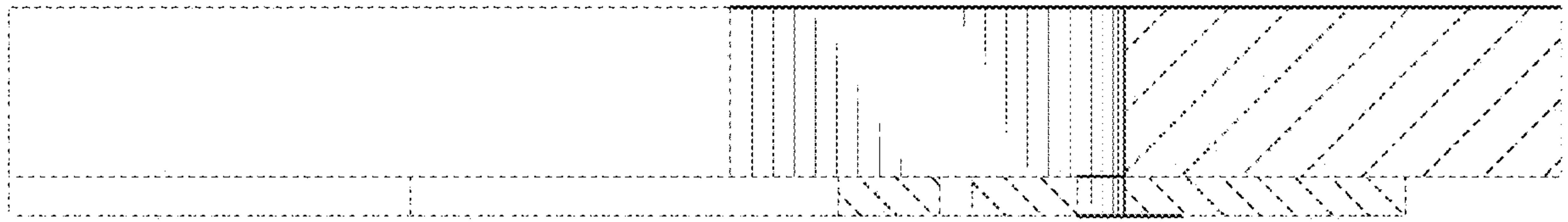

FIG. 33