



US00D901507S

(12) **United States Design Patent**
Klinkman et al.

(10) **Patent No.:** **US D901,507 S**

(45) **Date of Patent:** **** Nov. 10, 2020**

(54) **ELECTRONIC DOCK**

FOREIGN PATENT DOCUMENTS

(71) Applicant: **ACCO Brands Corporation**, Lake Zurich, IL (US)

EP 2866120 A1 4/2015
GB 2286630 A 8/1995

(Continued)

(72) Inventors: **Alex James Klinkman**, Hayward, CA (US); **Yu-Chia Huang**, New Taipei (TW)

OTHER PUBLICATIONS

Extended European Search Report and Search Opinion for Application No. 19183871.3 dated Jan. 24, 2020 (11 pages).

(73) Assignee: **ACCO BRANDS CORPORATION**, Lake Zurich, IL (US)

Primary Examiner — Marie D. Fast Horse

(74) *Attorney, Agent, or Firm* — Michael Best & Friedrich LLP

(**) Term: **15 Years**

(57) **CLAIM**

(21) Appl. No.: **29/662,398**

We claim the ornamental design for an electronic dock, as shown and described.

(22) Filed: **Sep. 5, 2018**

DESCRIPTION

(51) **LOC (12) Cl.** **14-02**

(52) **U.S. Cl.**
USPC **D14/434**

(58) **Field of Classification Search**
USPC ... D14/434, 433, 435, 435.1, 356, 357, 358, D14/440, 447, 251–253, 432, 451, 452, D14/454, 217, 240, 299, 496, 171; D13/103, 107, 108, 184, 110, 123, 133, D13/135; D21/333

CPC G06F 1/1632
See application file for complete search history.

FIG. 1 is a perspective view of an electronic dock embodying the present invention.

FIG. 2 is a top view of the electronic dock of FIG. 1.

FIG. 3 is a bottom view of the electronic dock of FIG. 1.

FIG. 4 is a front view of the electronic dock of FIG. 1.

FIG. 5 is a rear view of the electronic dock of FIG. 1.

FIG. 6 is a first side view of the electronic dock of FIG. 1.

FIG. 7 is a second side view of the electronic dock of FIG. 1.

FIG. 8 is a perspective view of another electronic dock for a portable electronic device embodying the invention.

FIG. 9 is a first side view of the electronic dock of FIG. 8.

FIG. 10 is a second side view of the electronic dock of FIG. 8.

FIG. 11 is a front view of the electronic dock of FIG. 8.

FIG. 12 is a rear view of the electronic dock of FIG. 8.

FIG. 13 is a top view of the electronic dock of FIG. 8; and,

FIG. 14 is a bottom view of the electronic dock of FIG. 8.

The broken lines in the drawings depict portions of the electronic dock that form no part of the claimed design.

(56) **References Cited**

U.S. PATENT DOCUMENTS

4,453,692	A	6/1984	LeDoux et al.	
D332,091	S *	12/1992	Iino	D14/434
5,305,381	A	4/1994	Wang et al.	
D354,280	S *	1/1995	Fenton	D14/137
D355,173	S *	2/1995	Fenton	D14/137
D355,412	S *	2/1995	Rak	D14/137

(Continued)

1 Claim, 10 Drawing Sheets

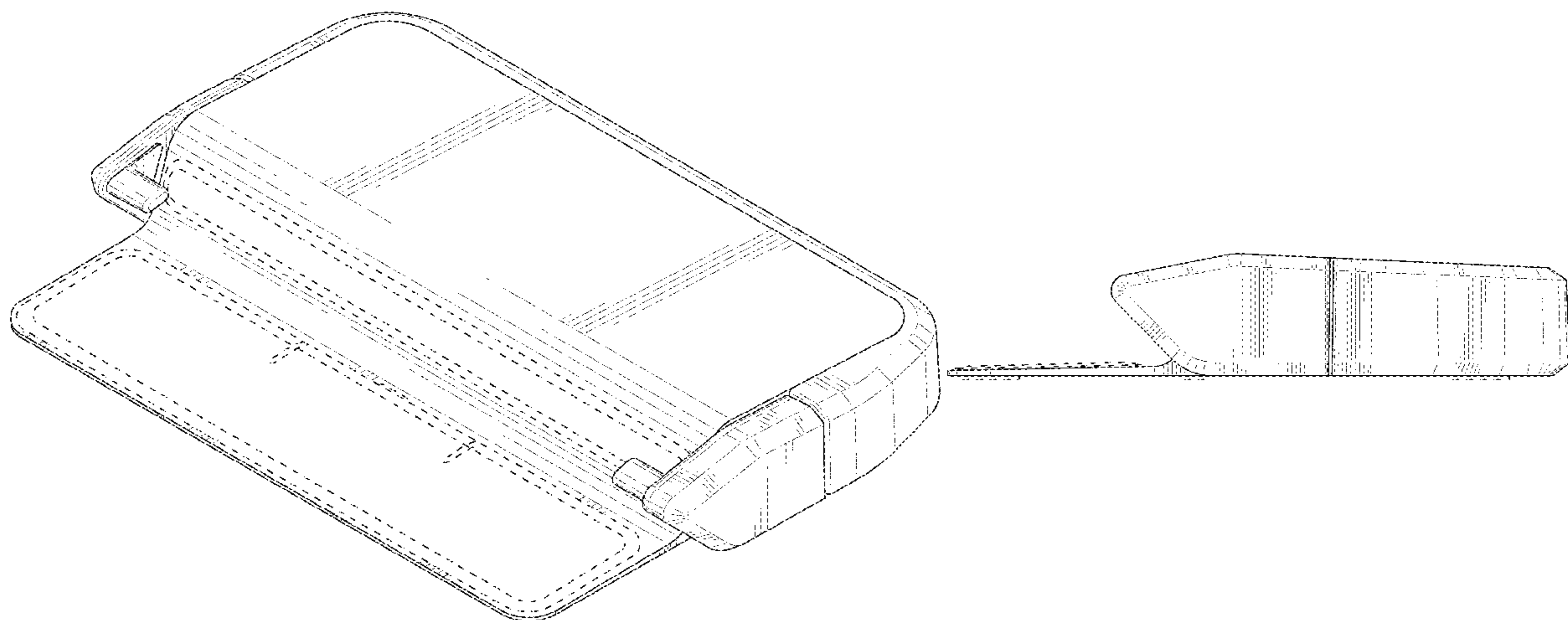

(56)

References Cited

U.S. PATENT DOCUMENTS

D358,834 S * 5/1995 Cox D18/34.2
 D359,065 S * 6/1995 Cox 412/37
 5,457,745 A 10/1995 Wang et al.
 5,461,546 A * 10/1995 Kobayashi G06F 1/1632
 361/679.44
 5,553,824 A 9/1996 Dutra, Jr.
 5,595,074 A 1/1997 Munro
 5,788,202 A 8/1998 Richter
 5,816,076 A 10/1998 Biedermann et al.
 5,903,645 A 5/1999 Tsay
 D415,740 S * 10/1999 Lee D14/434
 D415,741 S * 10/1999 Lee D14/434
 6,006,557 A 12/1999 Carl et al.
 D423,039 S * 4/2000 Cox D18/34.2
 6,069,790 A * 5/2000 Howell G06F 1/1632
 292/122
 6,072,695 A * 6/2000 Steiger G06F 1/1632
 361/679.41
 6,102,284 A 8/2000 Myers et al.
 6,115,247 A 9/2000 Helot
 D434,417 S * 11/2000 Lin D14/432
 6,185,095 B1 * 2/2001 Helot G06F 1/1632
 312/223.1
 6,212,921 B1 4/2001 Knighton
 6,256,387 B1 7/2001 Wang
 D448,385 S * 9/2001 Oross D14/432
 D450,708 S * 11/2001 Hsu D14/435
 6,320,962 B1 11/2001 Eisenbraun
 6,490,154 B2 12/2002 Thompson
 6,533,599 B1 * 3/2003 Singleton, Jr. G06F 1/1632
 361/679.43
 6,560,101 B1 * 5/2003 Oross G06F 1/1632
 361/679.43
 6,560,710 B1 5/2003 Leyden et al.
 D478,087 S * 8/2003 Aldridge D14/433
 6,667,881 B2 * 12/2003 Oross G06F 1/1632
 361/679.4
 6,711,921 B1 3/2004 Yang
 6,796,536 B1 9/2004 Sevier, IV
 D504,148 S * 4/2005 Smith D18/34.2
 6,883,694 B2 4/2005 Abelow
 D507,808 S * 7/2005 Smith D18/34.2
 6,913,238 B2 7/2005 Bakker et al.
 D512,066 S * 11/2005 Solomon D14/434
 7,007,912 B1 3/2006 Giuliani et al.
 7,032,872 B2 4/2006 Sullivan
 D532,368 S * 11/2006 Yamada D13/108
 7,174,752 B2 2/2007 Galant
 D554,582 S * 11/2007 Iseki D13/108
 7,315,443 B2 1/2008 Allen
 7,324,333 B2 1/2008 Allen
 7,407,143 B1 8/2008 Chen
 7,443,665 B2 10/2008 Allen
 7,506,592 B2 3/2009 Rossini
 7,633,750 B2 * 12/2009 Fan G06F 1/1632
 361/679.41
 7,724,520 B2 5/2010 Allen
 D638,010 S * 5/2011 de Wilde D14/300

8,139,356 B2 3/2012 Allen
 8,144,462 B2 3/2012 Chen
 8,223,488 B2 7/2012 Peter
 8,567,737 B2 10/2013 Chen
 D701,213 S * 3/2014 Pajic D14/447
 8,708,296 B2 4/2014 Nemoto
 8,717,758 B2 5/2014 Allen
 8,727,192 B2 5/2014 Lai
 8,777,173 B2 7/2014 Nemoto
 8,837,144 B1 9/2014 Allen
 8,882,069 B2 11/2014 Mahaffey et al.
 9,004,434 B2 4/2015 Kang et al.
 D732,036 S * 6/2015 Lee D14/434
 9,047,051 B2 6/2015 Yu et al.
 9,115,843 B2 8/2015 Huang
 9,194,532 B2 11/2015 Bisesti et al.
 9,206,626 B2 12/2015 Allen
 9,334,679 B2 5/2016 Lin
 9,388,939 B2 7/2016 Girault
 D768,069 S * 10/2016 Hoshikawa D13/103
 9,486,897 B2 11/2016 Trotsky
 9,562,375 B2 2/2017 Allen
 9,573,532 B2 2/2017 Riddiford et al.
 9,650,810 B2 5/2017 Grziwok et al.
 D795,876 S * 8/2017 Fletcher D14/434
 9,797,543 B2 10/2017 Lin
 10,125,523 B2 11/2018 Allen
 D851,646 S * 6/2019 Huebner D14/434
 2003/0128506 A1 7/2003 Won et al.
 2004/0007651 A1 1/2004 Williams et al.
 2004/0065126 A1 4/2004 Yang
 2004/0177658 A1 9/2004 Mitchell
 2005/0077448 A1 4/2005 Rossini
 2006/0215836 A1 9/2006 Wang
 2006/0250767 A1 * 11/2006 Brophy G06F 1/1632
 361/679.45
 2007/0262223 A1 11/2007 Wang et al.
 2009/0294617 A1 12/2009 Stacey et al.
 2010/0044534 A1 2/2010 He et al.
 2010/0079285 A1 4/2010 Fawcett et al.
 2010/0264182 A1 10/2010 Perlman et al.
 2011/0062299 A1 3/2011 Tsai
 2011/0134601 A1 6/2011 Sa
 2011/0185776 A1 8/2011 Mahaffey et al.
 2012/0312936 A1 12/2012 Huang
 2013/0148289 A1 6/2013 Kwon
 2014/0069195 A1 3/2014 Ledbetter
 2015/0083885 A1 3/2015 Mahaffey et al.
 2015/0185709 A1 7/2015 Vroom et al.
 2018/0058107 A1 3/2018 Lucas et al.
 2018/0132364 A1 5/2018 Apter
 2018/0252003 A1 * 9/2018 Klinkman E05B 73/0082
 2019/0078355 A1 3/2019 Allen
 2019/0284843 A1 9/2019 Weng
 2020/0073438 A1 * 3/2020 Huang G06F 1/1624

FOREIGN PATENT DOCUMENTS

GB 2300879 A 11/1996
 WO 2002035037 A1 5/2002

* cited by examiner

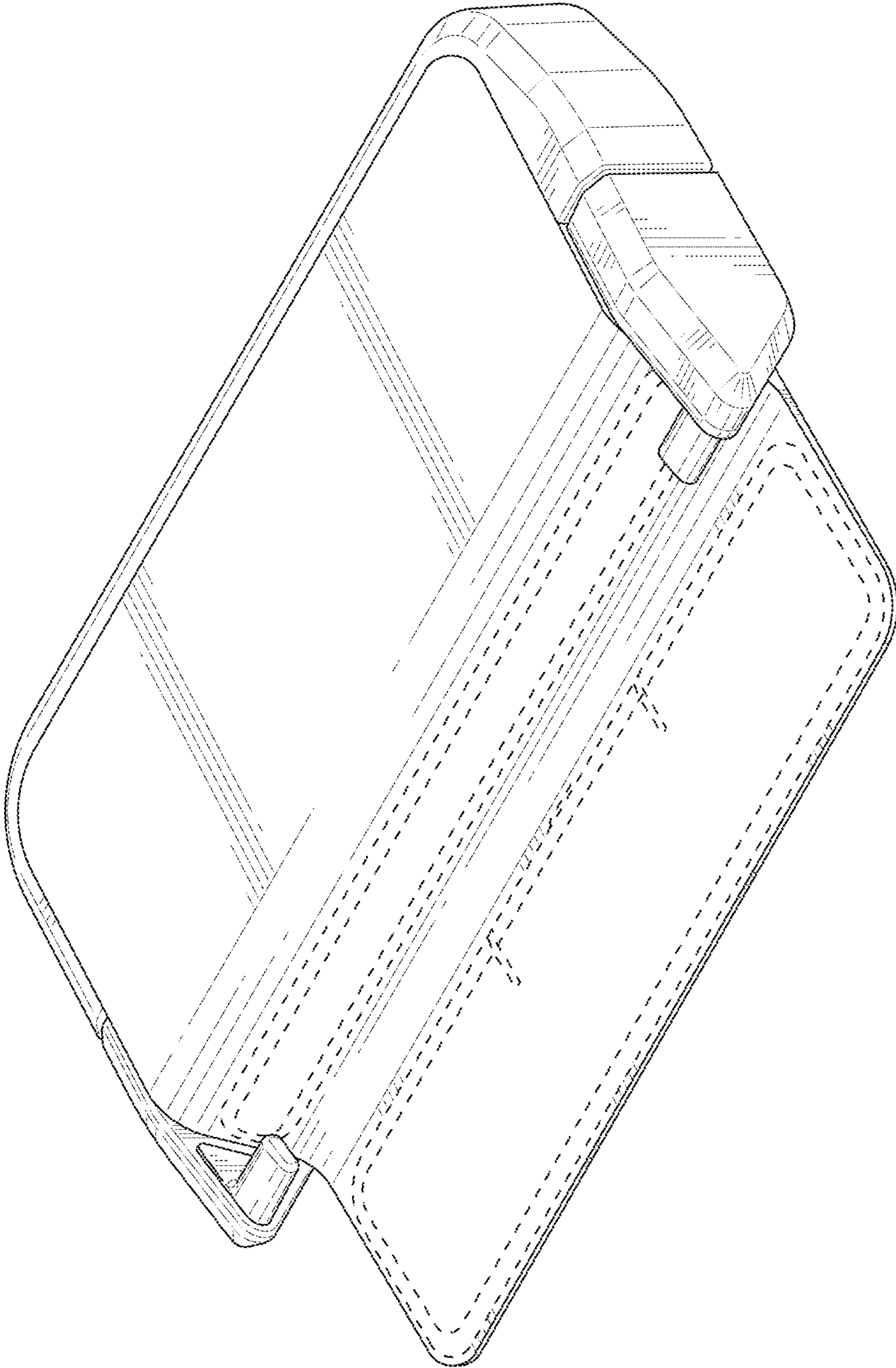

FIG. 1

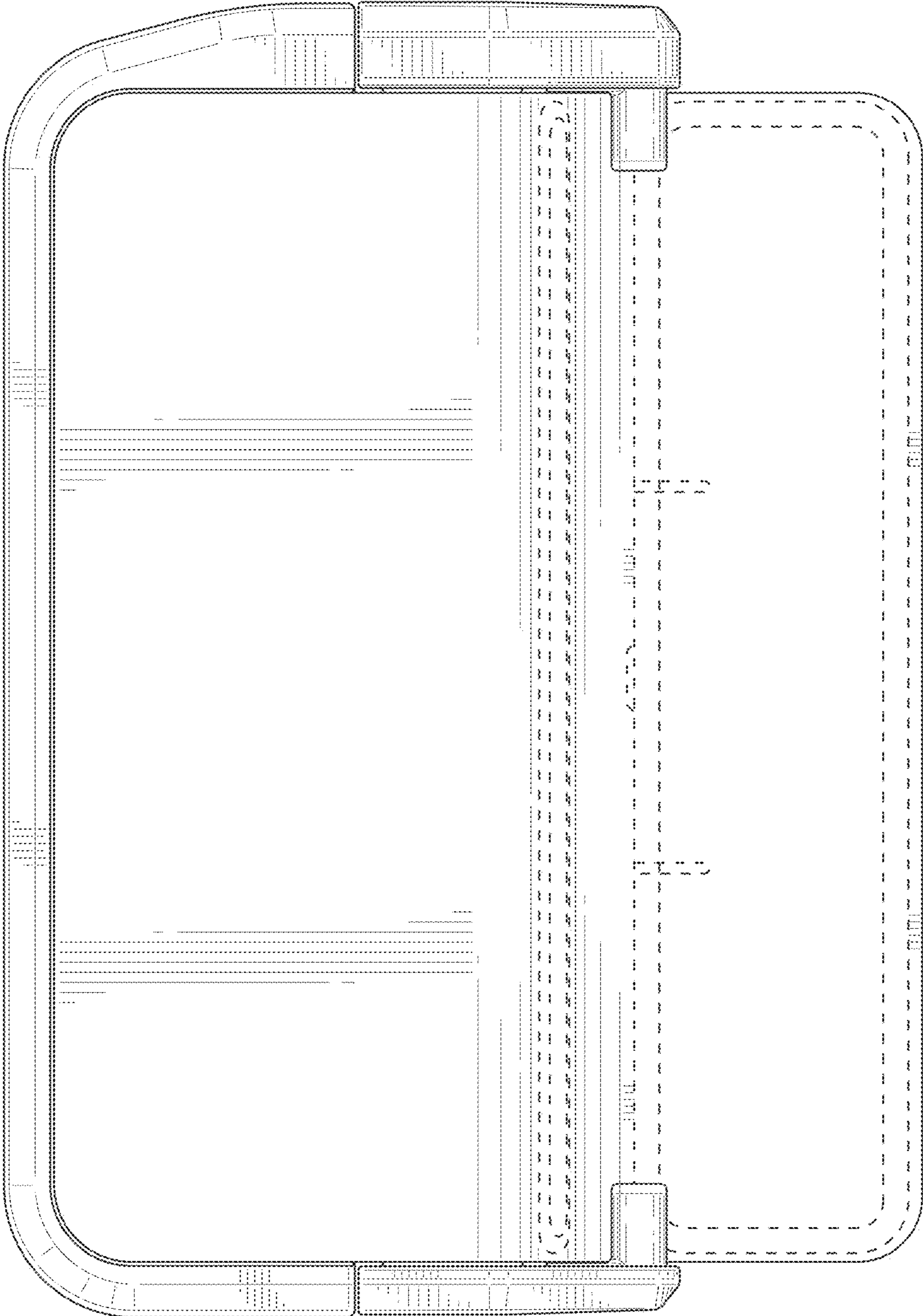

FIG. 2

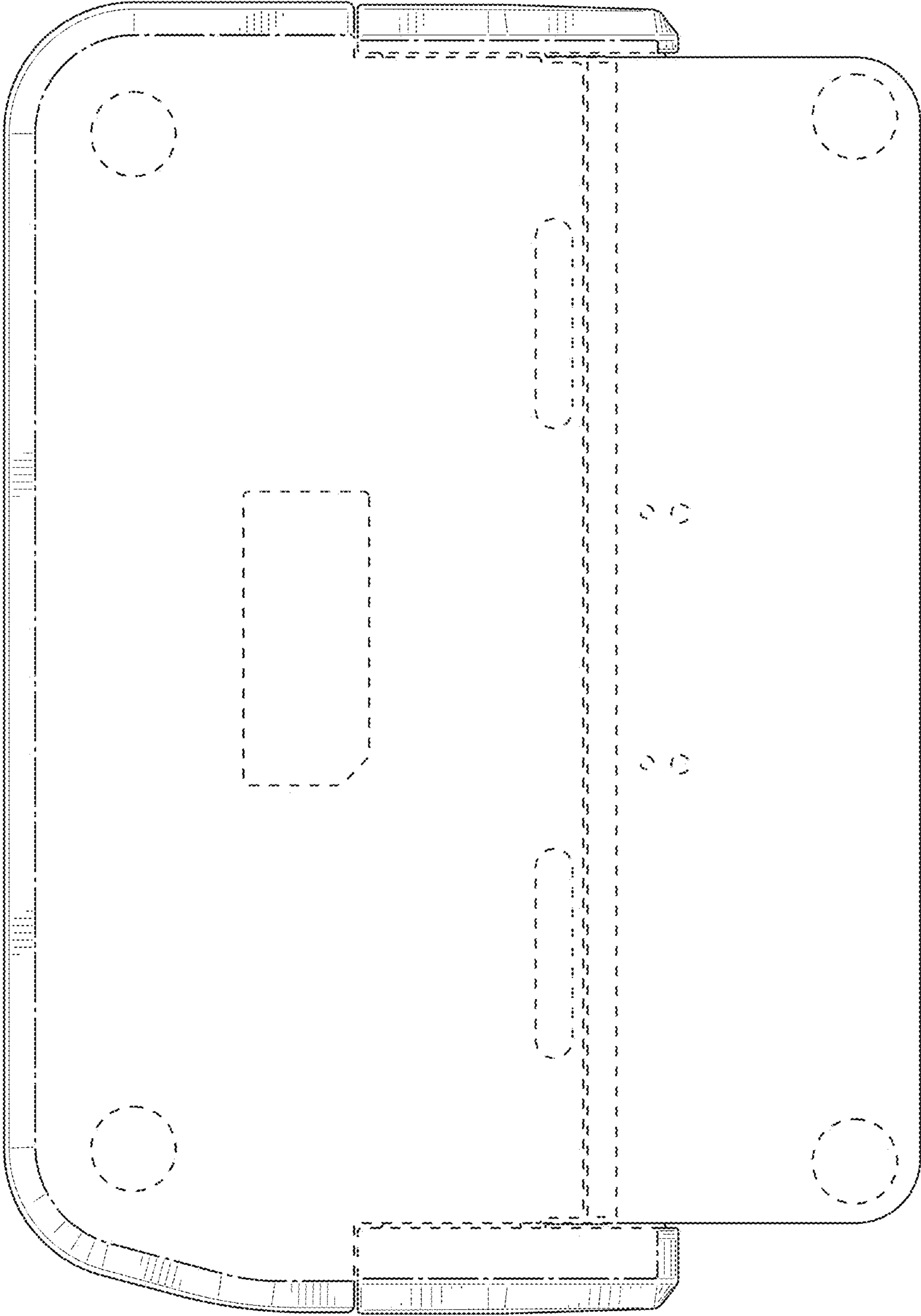

FIG. 3

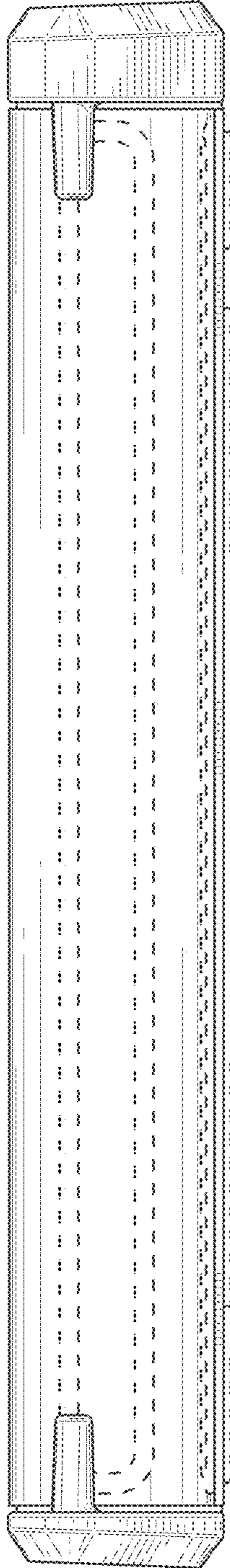

FIG. 4

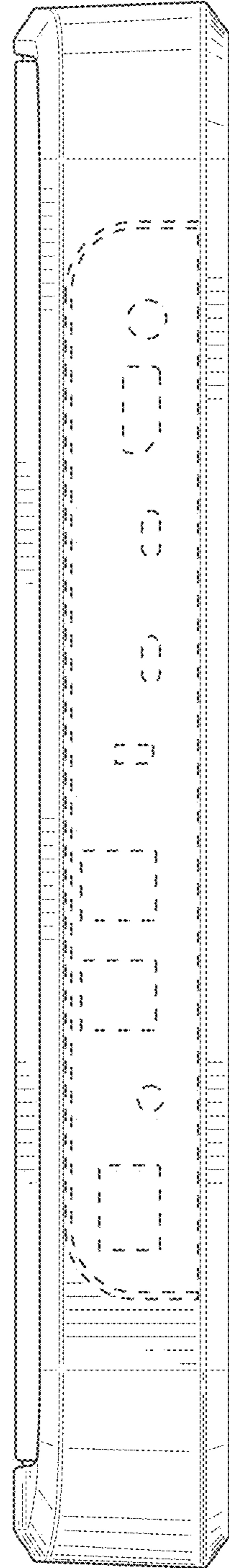

FIG. 5

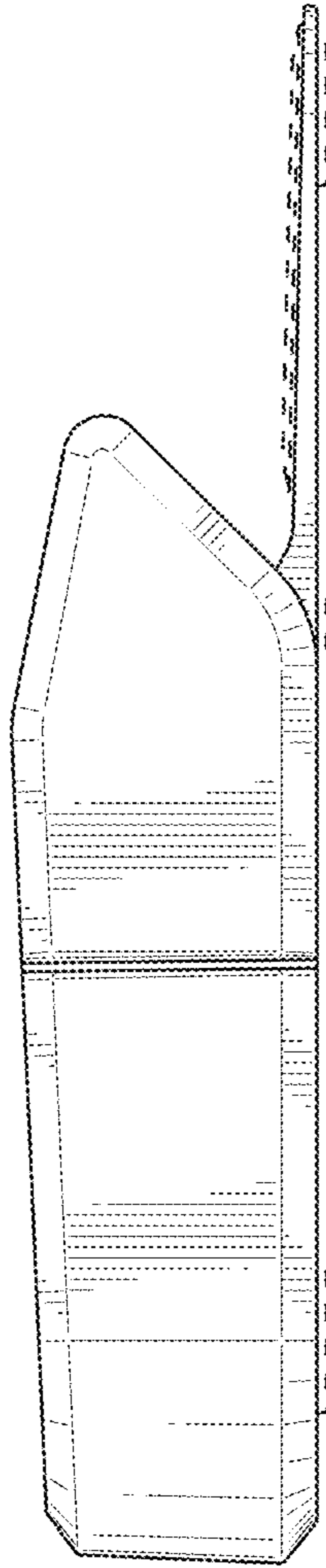

FIG. 6

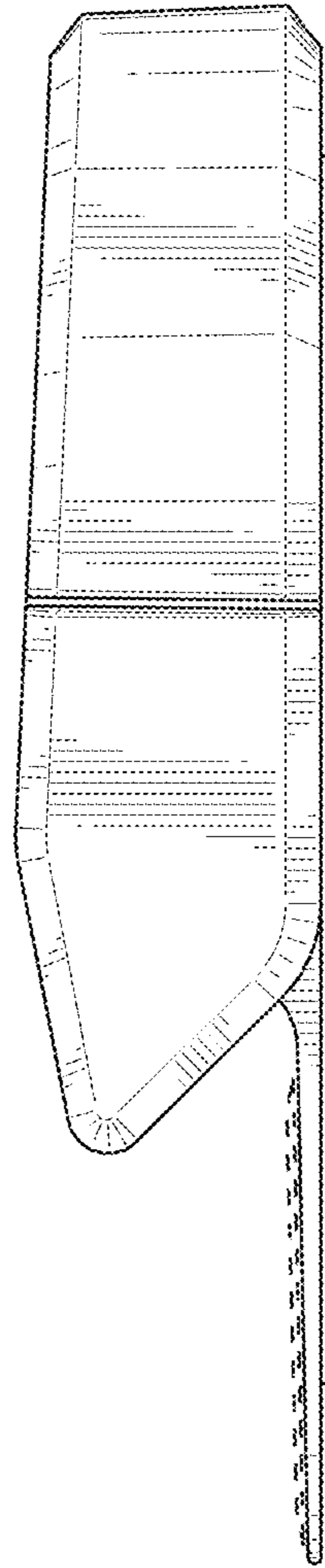

FIG. 7

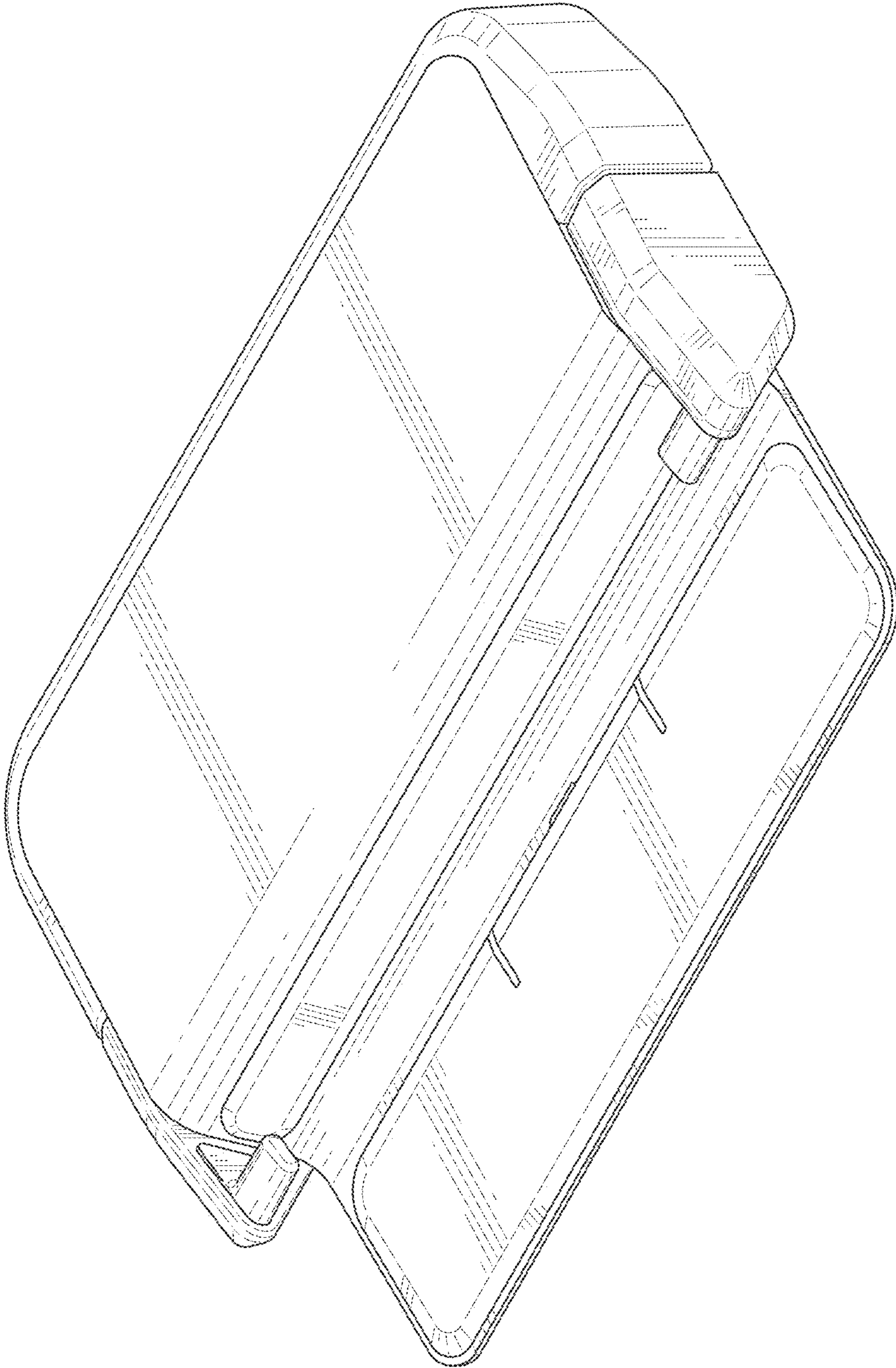

FIG. 8

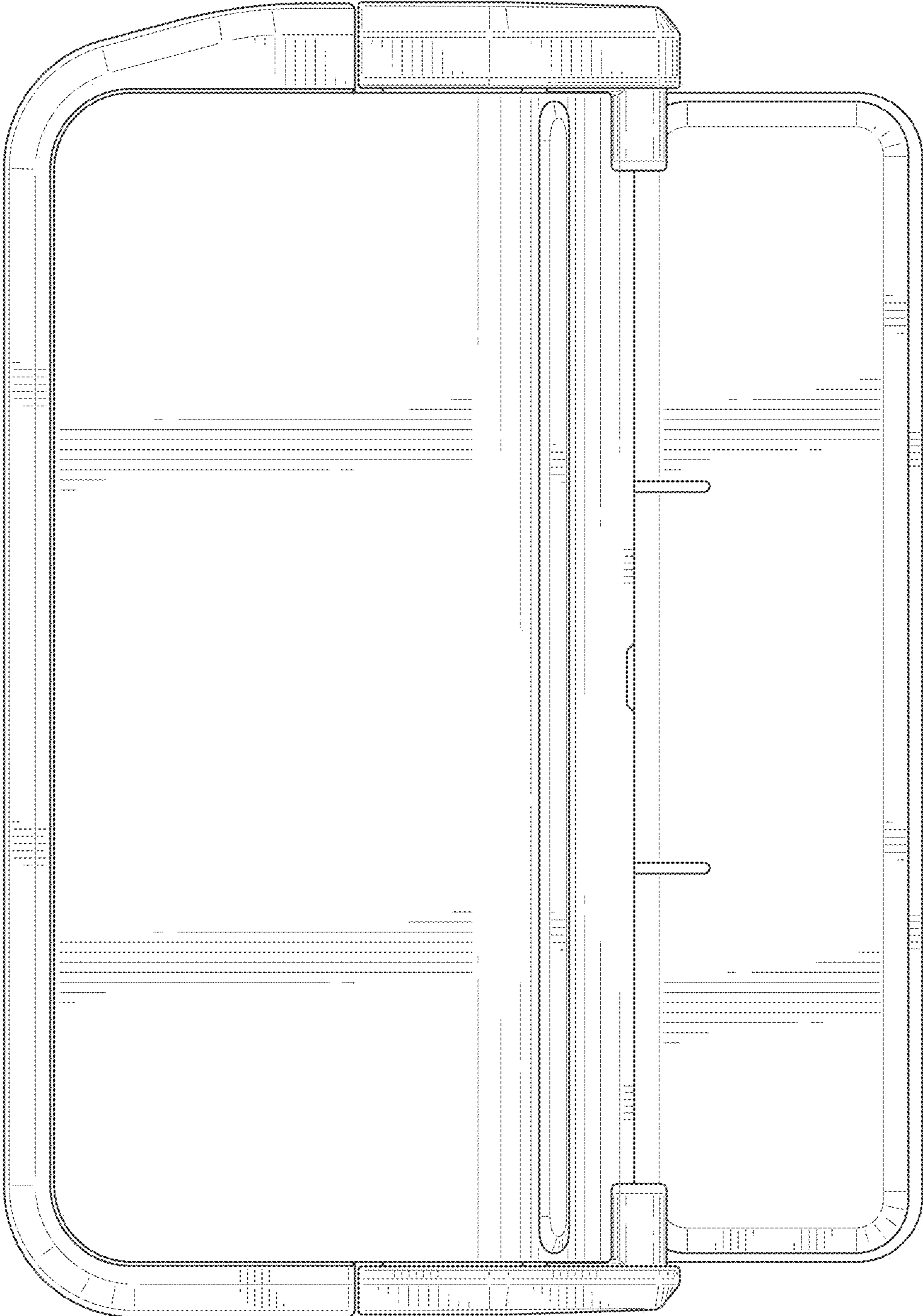

FIG. 9

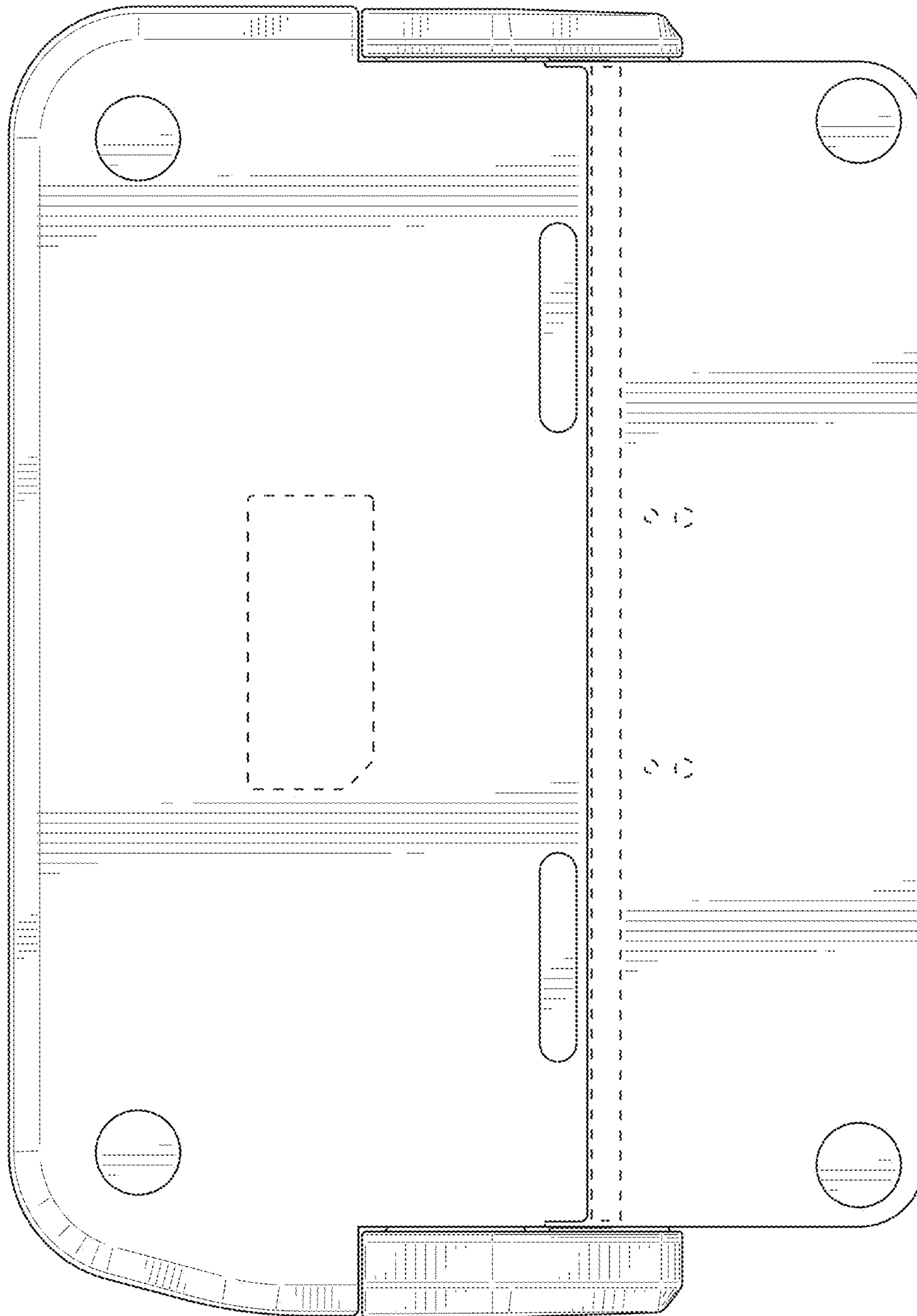

FIG. 10

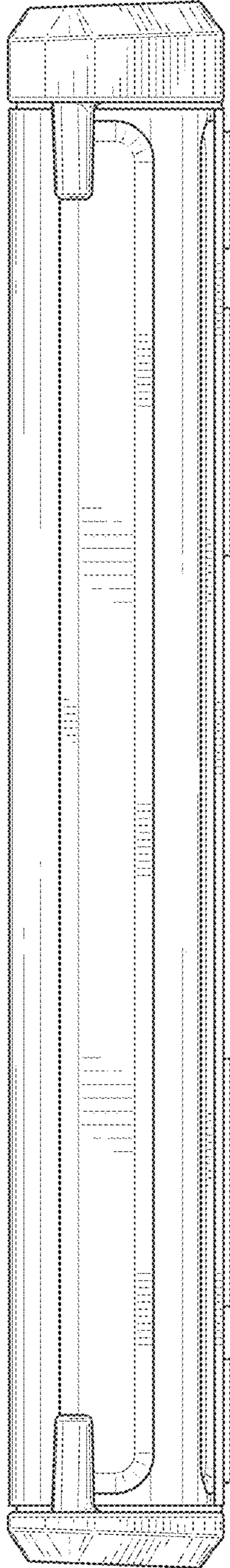

FIG. 11

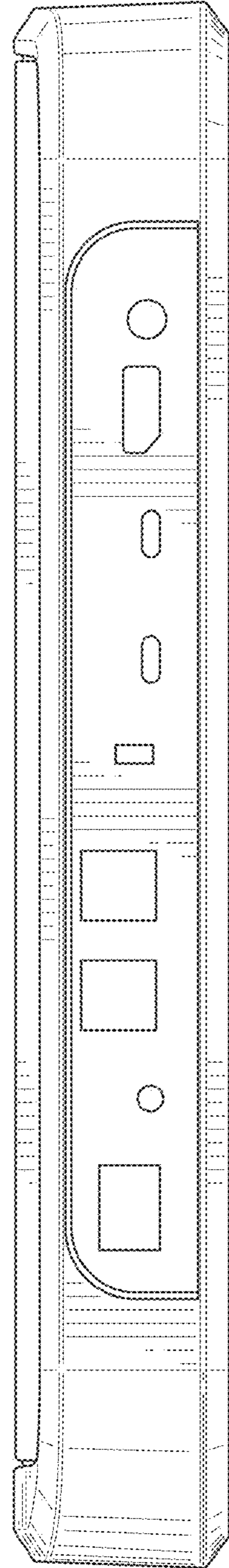

FIG. 12

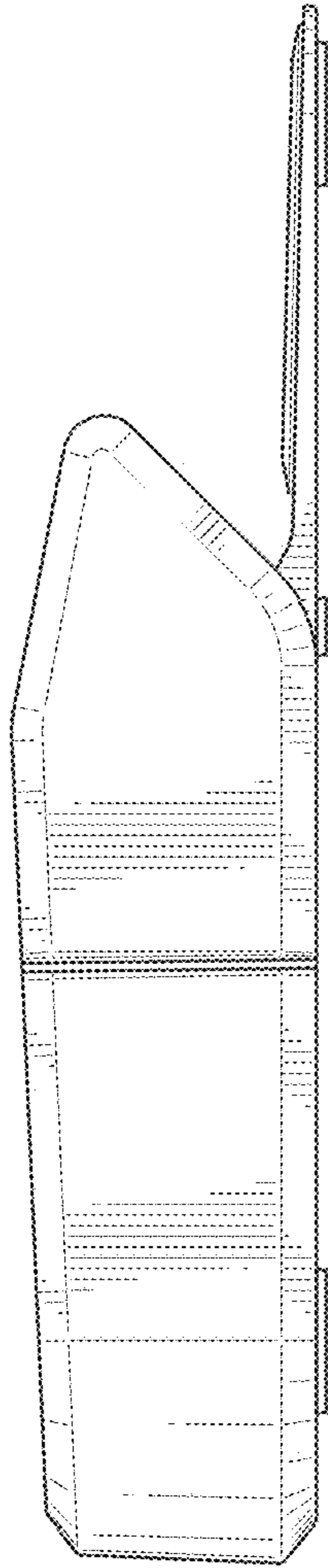

FIG. 13

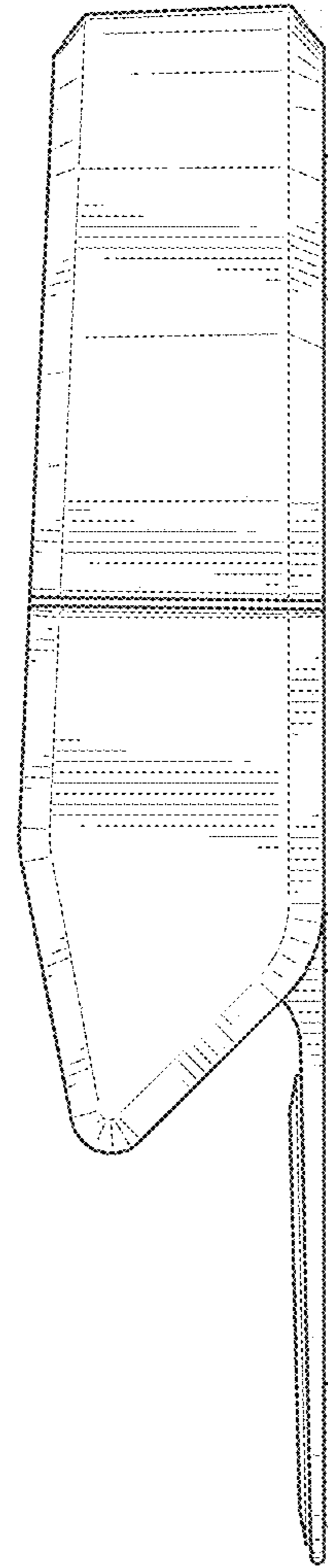

FIG. 14