



US00D901452S

(12) **United States Design Patent** (10) **Patent No.:** **US D901,452 S**
Maier (45) **Date of Patent:** **** Nov. 10, 2020**

(54) **REMOTE CONTROL WIRELESS**
(71) Applicant: **Fm marketing gmbh**, Neumarkt am Wallersee (AT)
(72) Inventor: **Ferdinand Maier**, Neumarkt am Wallersee (AT)
(**) Term: **15 Years**
(21) Appl. No.: **35/507,602**
(22) Filed: **Apr. 2, 2019**
(80) **Hague Agreement Data**

Primary Examiner — Khawaja Anwar

(57) **CLAIM**

The ornamental design for remote control wireless, as shown and described.

(80) **Hague Agreement Data**
Int. Filing Date: **Apr. 2, 2019**
Int. Reg. No.: **DM/203595**
Int. Reg. Date: **Apr. 2, 2019**
Int. Reg. Pub. Date: **Nov. 1, 2019**
(51) **LOC (12) Cl.** **14-03**
(52) **U.S. Cl.**
USPC **D14/218**
(58) **Field of Classification Search**
USPC D14/324-333, 217, 218; D13/158, 162, D13/168
CPC H04B 3/52; H04B 17/373; H04B 2203/5441; H04B 3/28; H04B 3/54; H04B 3/58; H04B 10/116; H04B 10/27; H04B 10/5563; H04B 10/807; H04B 17/27; H04B 17/309; H04B 17/345; H04B 17/382; H04B 1/74; H04B 2203/5483; H04B 3/46; H04B 3/56; H04B 5/0031; H04B 7/026; H04B 7/04; H04B 7/0456; H04B 7/0469; H04B 7/0491; H04B 7/06; H04B 7/0606; H04B 7/0689; H04B 7/15535; H04B 7/2606; H04B 7/265; G08B 21/0236; G08B 21/0261; G08B 21/0269; G08B 21/0272; G08B 13/19656; G08B 13/19665
See application file for complete search history.

DESCRIPTION

- 1.-4. Remote control
- 1.1 : Top
- 1.2 : Left
- 1.3 : Right
- 1.4 : Back
- 1.5 : Bottom
- 1.6 : Perspective
- 1.7 : Front
- 2.1 : Top
- 2.2 : Left
- 2.3 : Right
- 2.4 : Back
- 2.5 : Perspective
- 2.6 : Front
- 2.7 : Bottom
- 3.1 : Perspective
- 3.2 : Front
- 3.3 : Back
- 3.4 : Right
- 3.5 : Left
- 3.6 : Top
- 3.7 : Bottom
- 4.1 : Back
- 4.2 : Bottom
- 4.3 : Top
- 4.4 : Left
- 4.5 : Front
- 4.6 : Right
- 4.7 : Perspective

(56) **References Cited**
U.S. PATENT DOCUMENTS

D597,082 S * 7/2009 Bang D14/218
D648,327 S * 11/2011 Maier D14/218
D658,636 S * 5/2012 Maier D14/218
D664,945 S * 8/2012 Morris D14/218

(Continued)

1 Claim, 28 Drawing Sheets

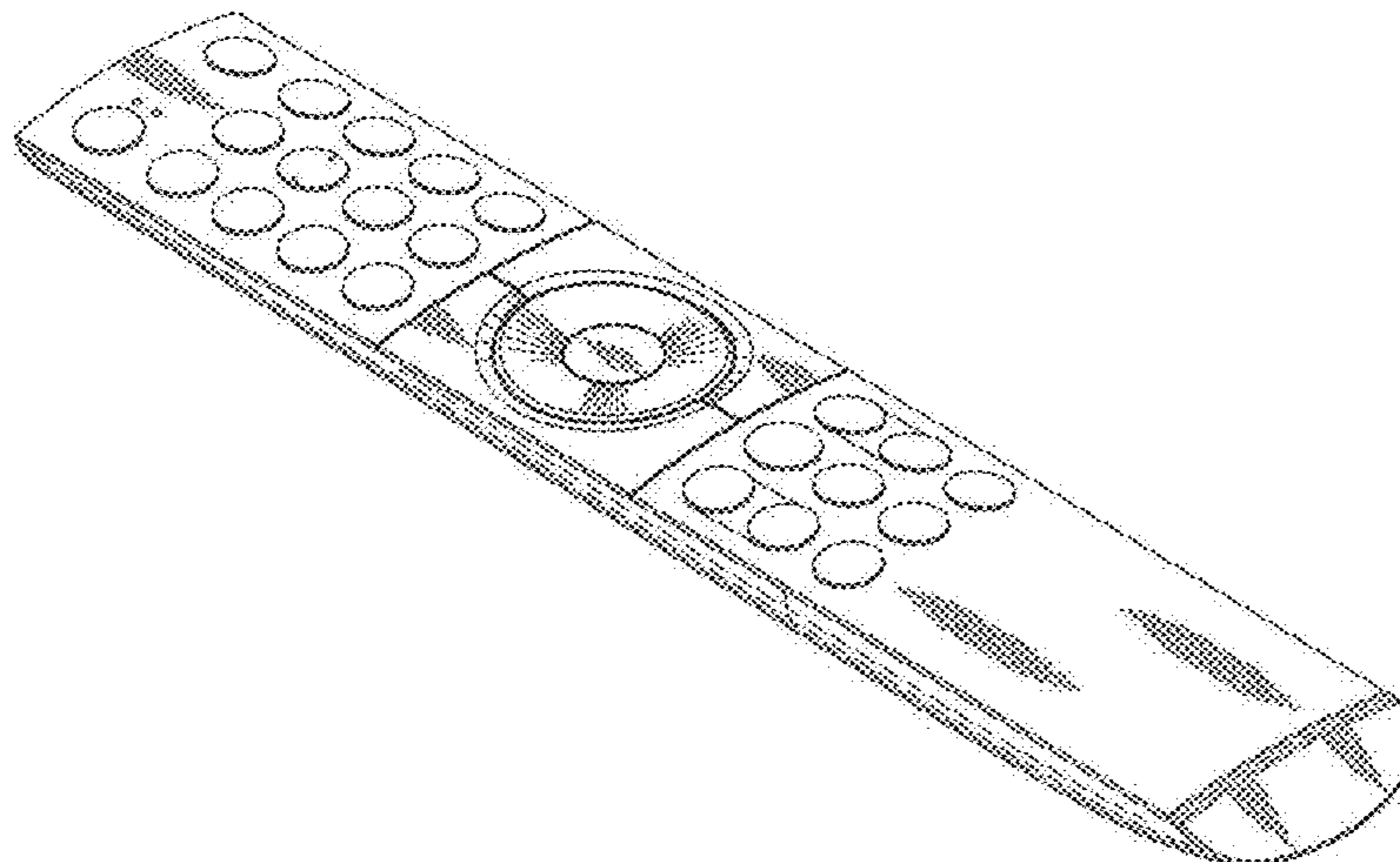

(56)

References Cited

U.S. PATENT DOCUMENTS

D703,188	S	*	4/2014	Maier	D14/218
D803,815	S	*	11/2017	Maier	D14/218
D808,931	S	*	1/2018	Maier	D14/218
D828,336	S	*	9/2018	Matvienko	D14/218
D835,075	S	*	12/2018	Maier	D14/218
D848,977	S	*	5/2019	Pang	D14/218
D850,413	S	*	6/2019	Tu	D14/218
D851,631	S	*	6/2019	Einaudi	D14/218
D856,308	S	*	8/2019	Pang	D14/218
D856,978	S	*	8/2019	Lu	D14/218
D866,527	S	*	11/2019	Maier	D14/218
D868,040	S	*	11/2019	Desagre	D14/218
D872,710	S	*	1/2020	Tu	D14/218
D887,393	S	*	6/2020	Maier	D14/218

* cited by examiner

1.1

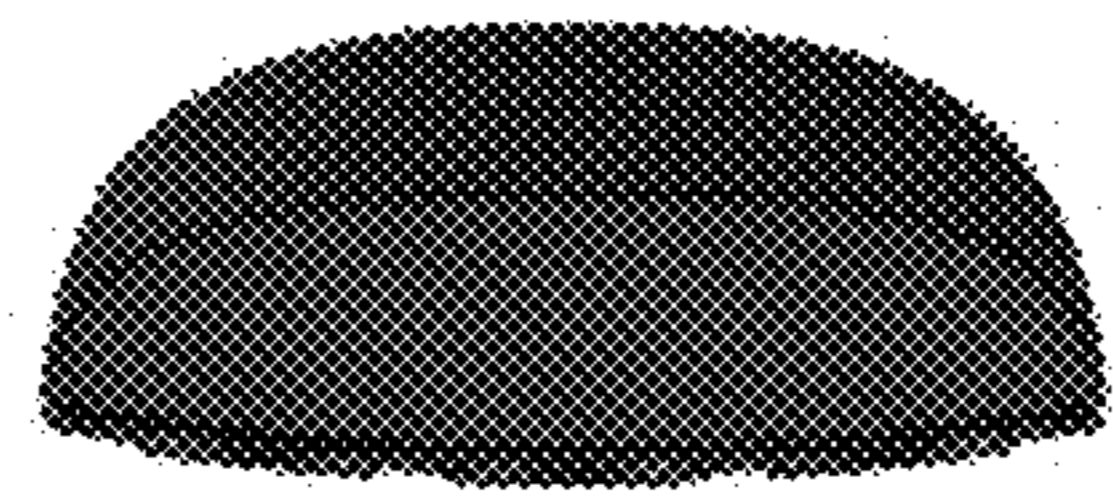

1.2

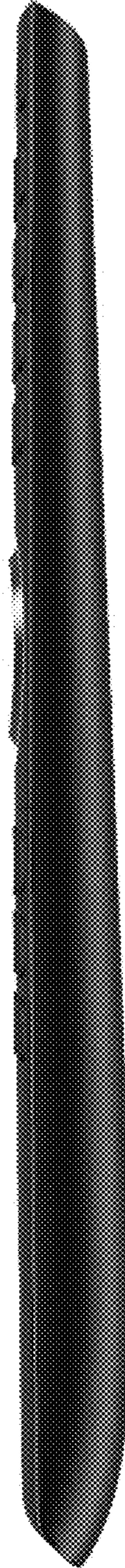

1.3

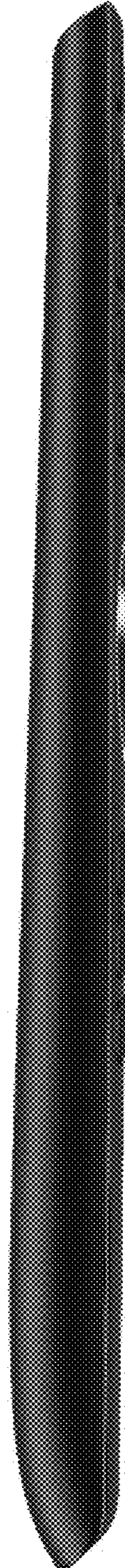

1.4

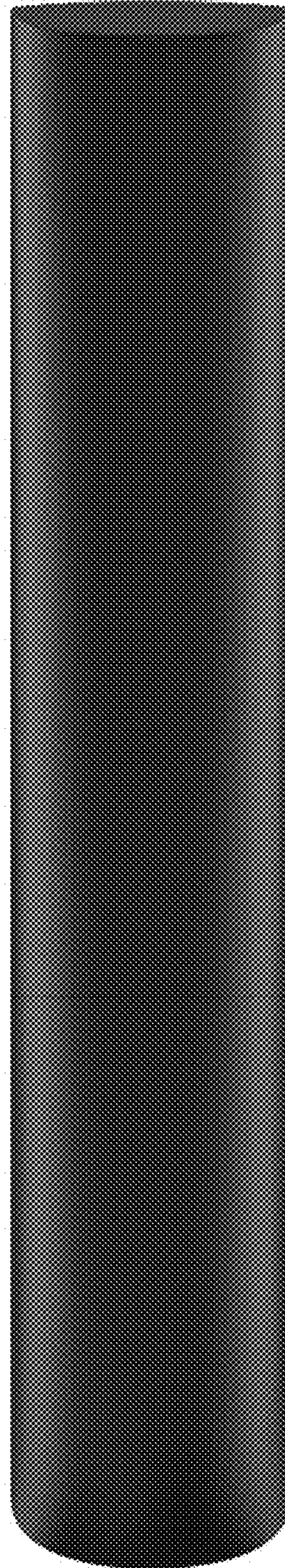

1.5

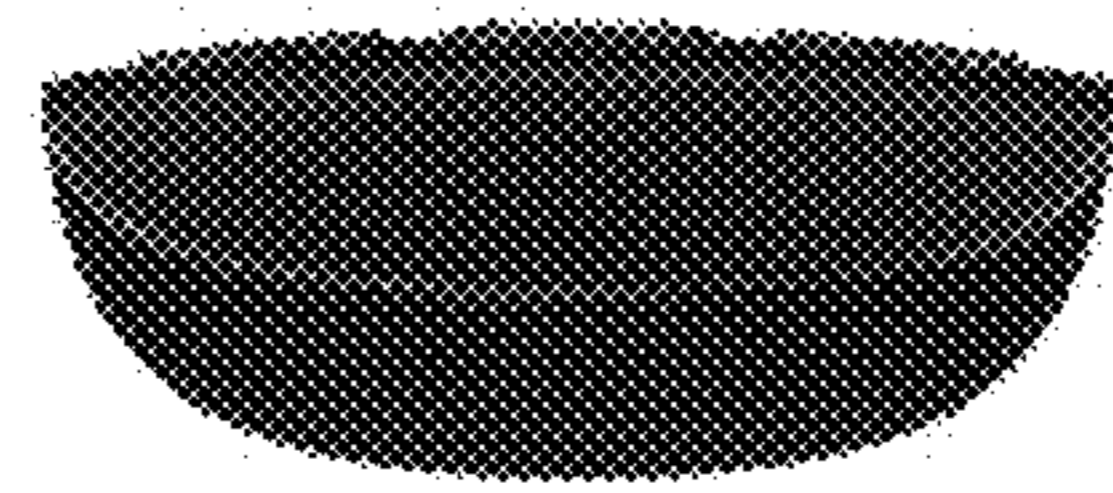

1.6

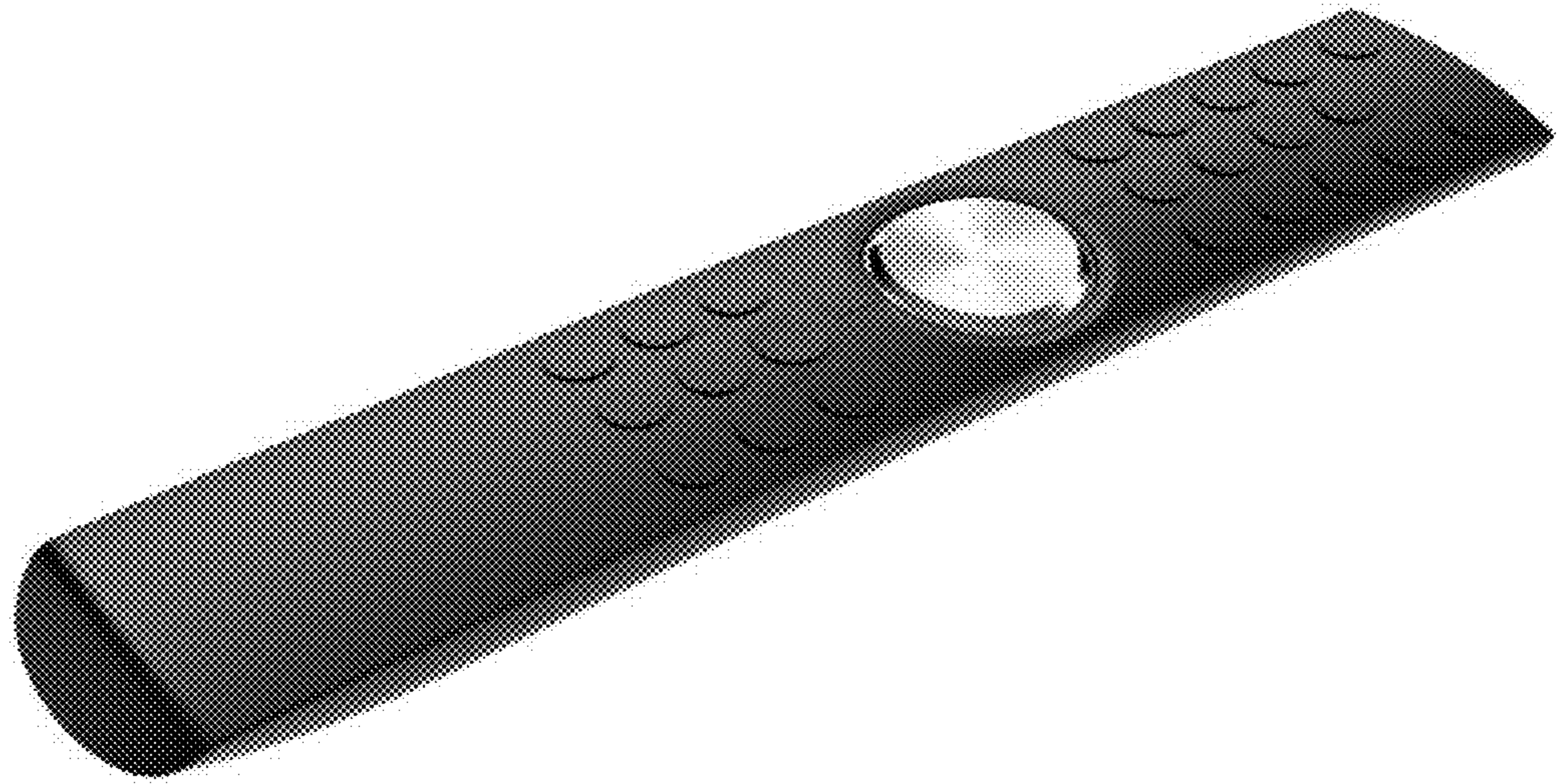

1.7

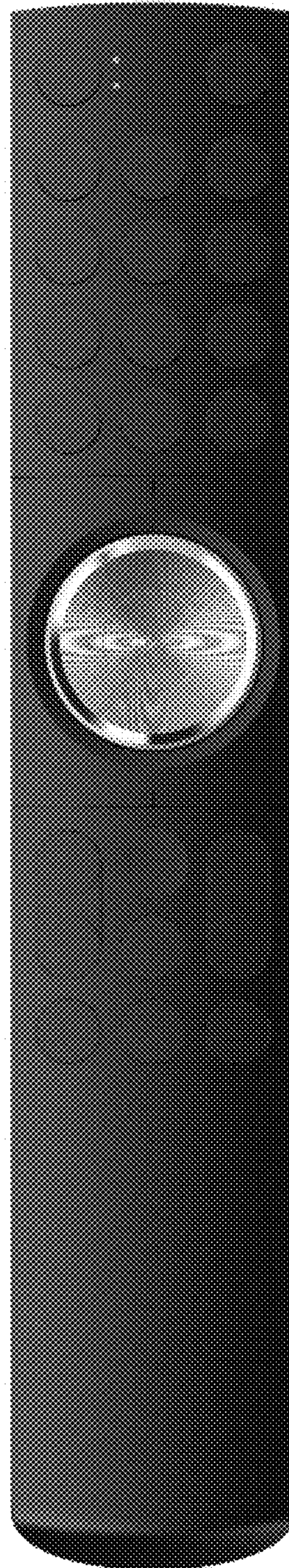

2.1

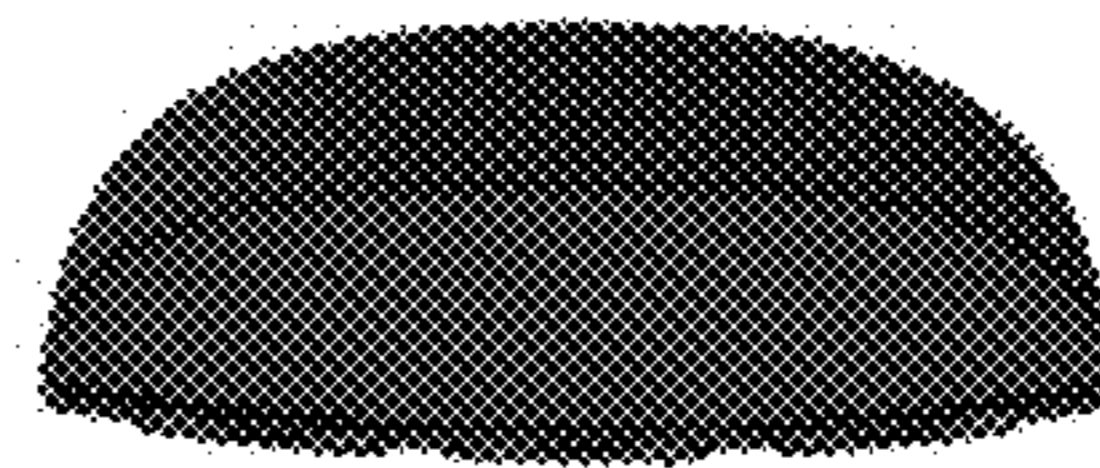

2.2

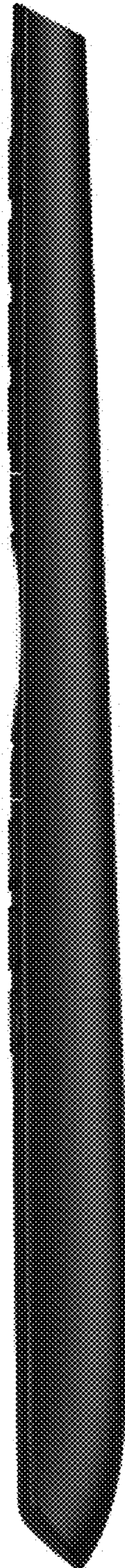

2.3

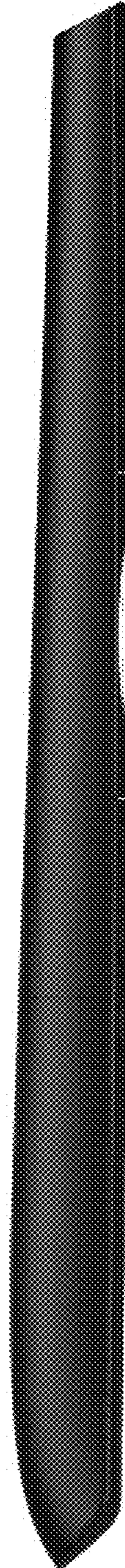

2.4

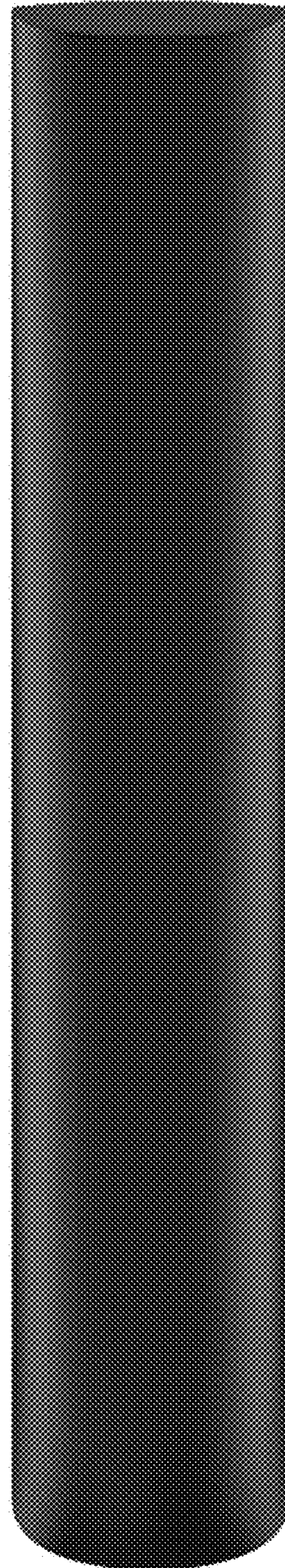

2.5

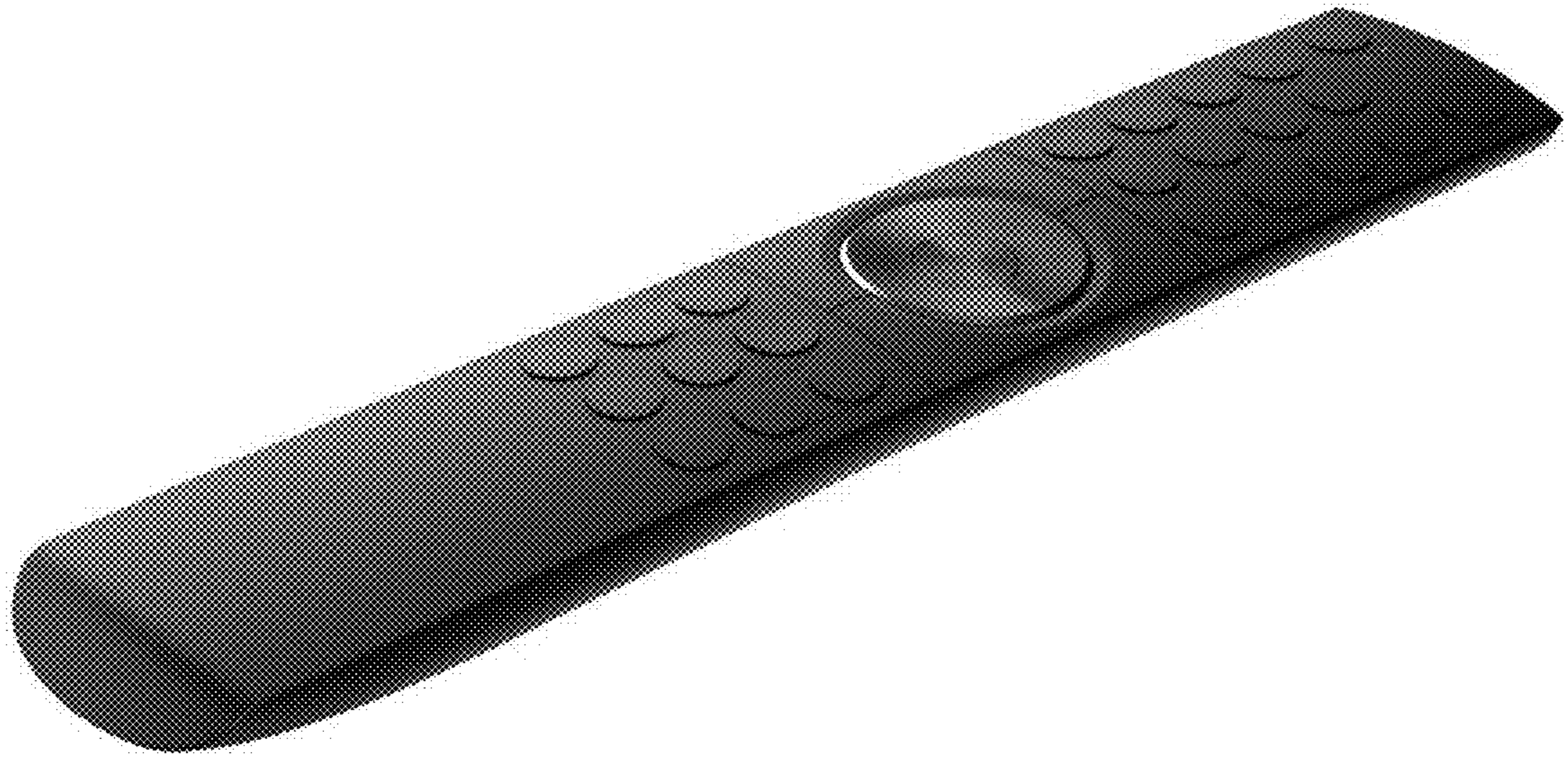

2.6

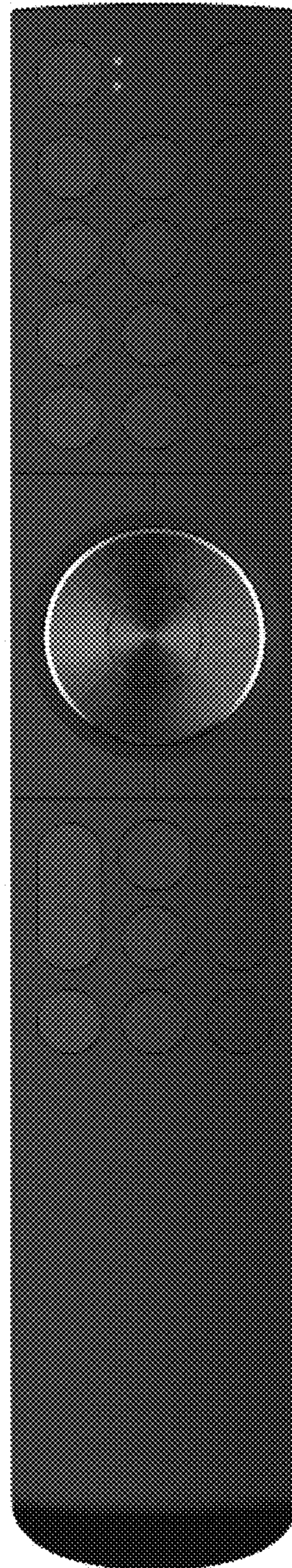

2.7

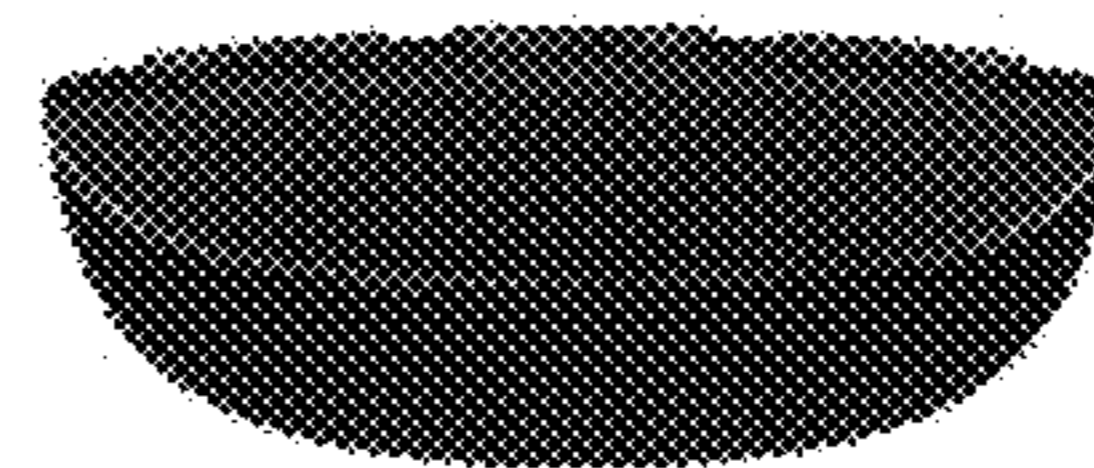

3.1

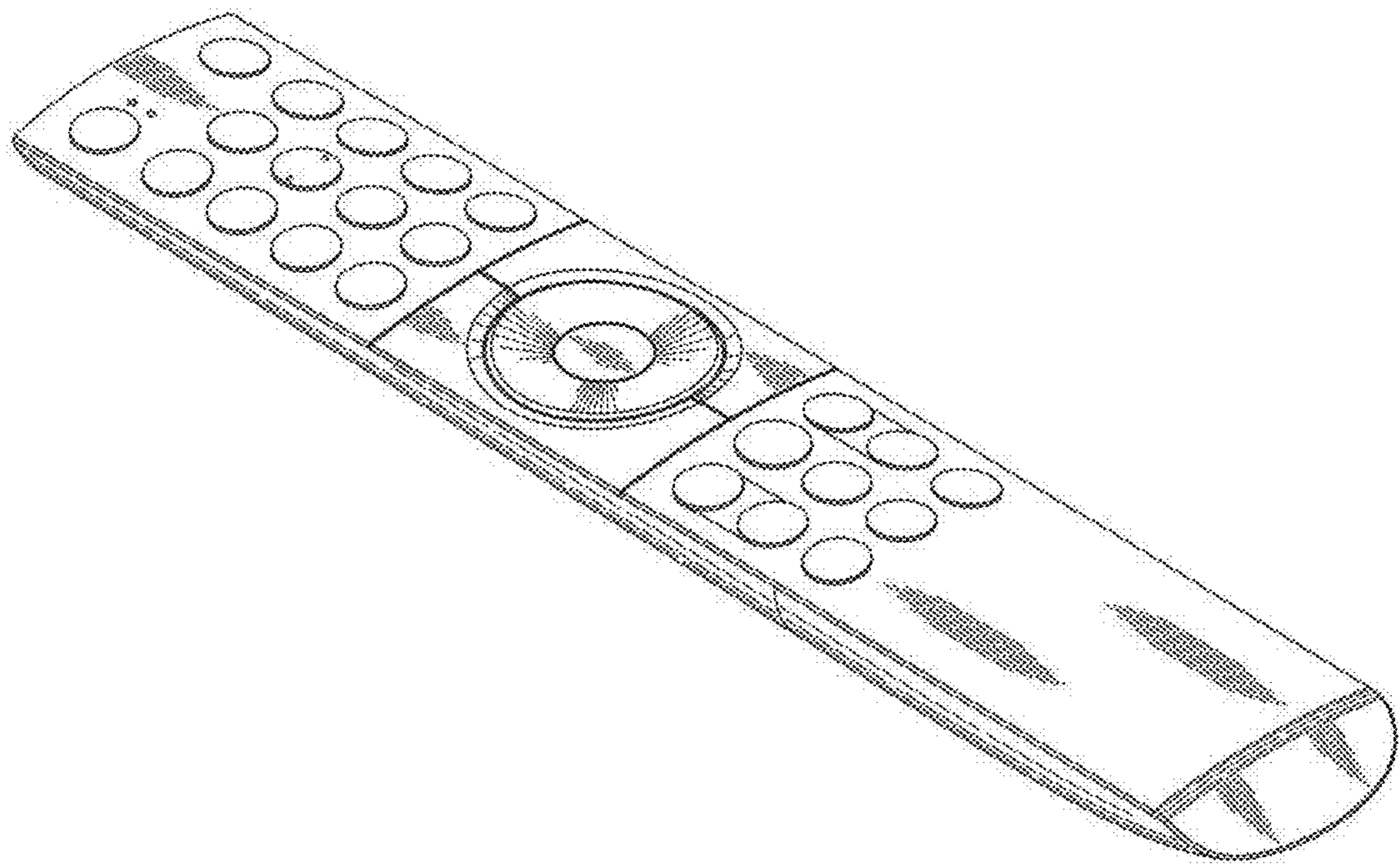

3.2

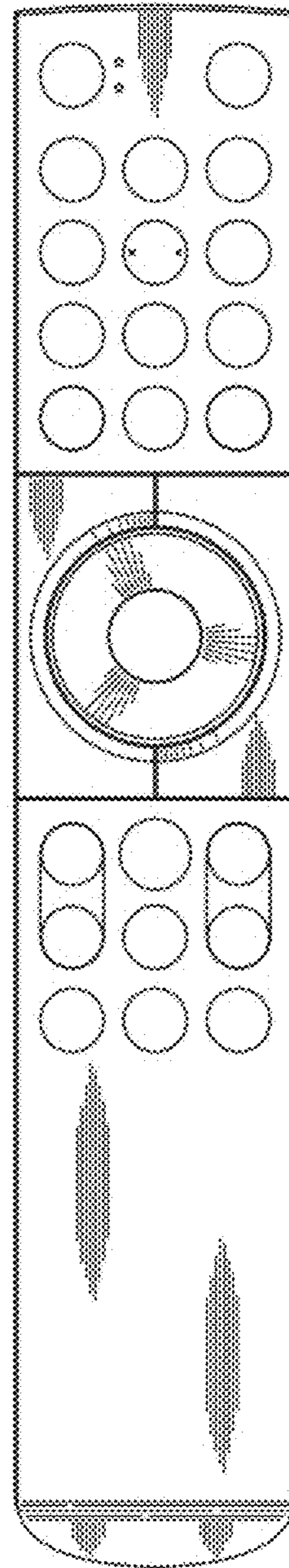

3.3

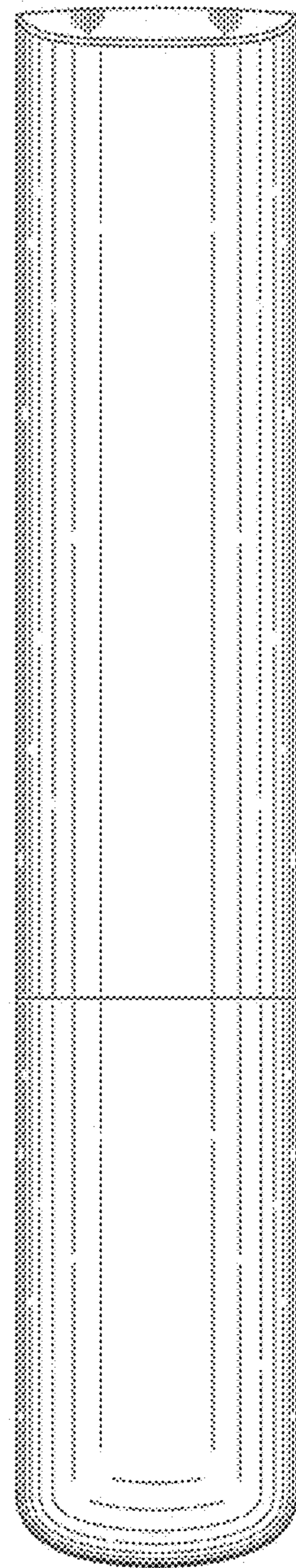

3.4

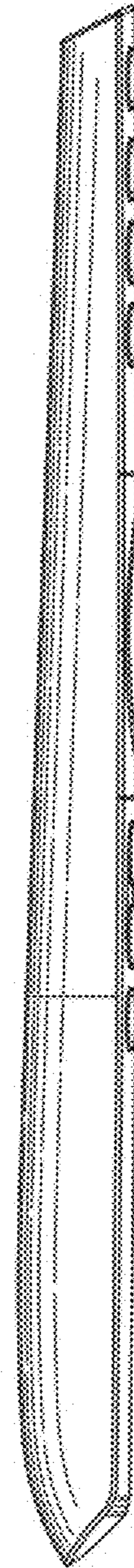

3.5

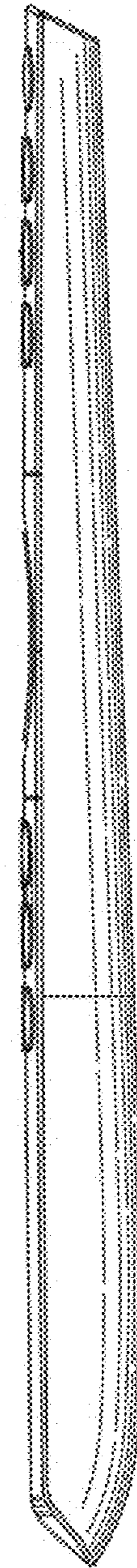

3.6

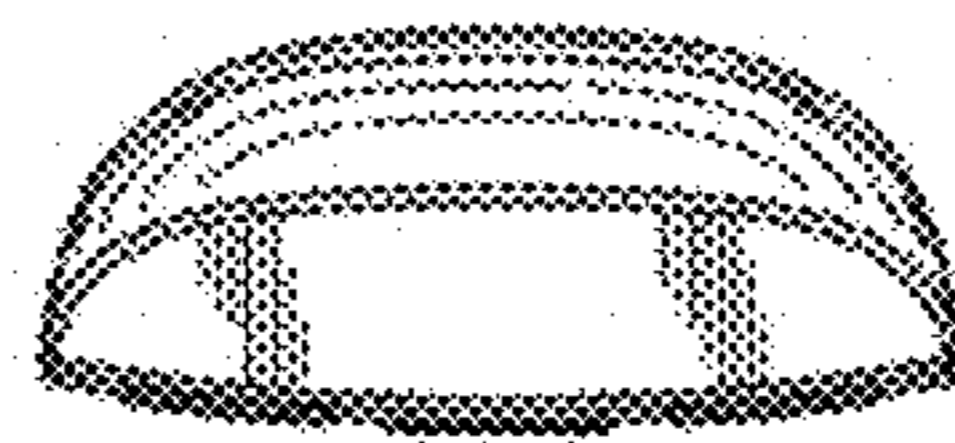

3.7

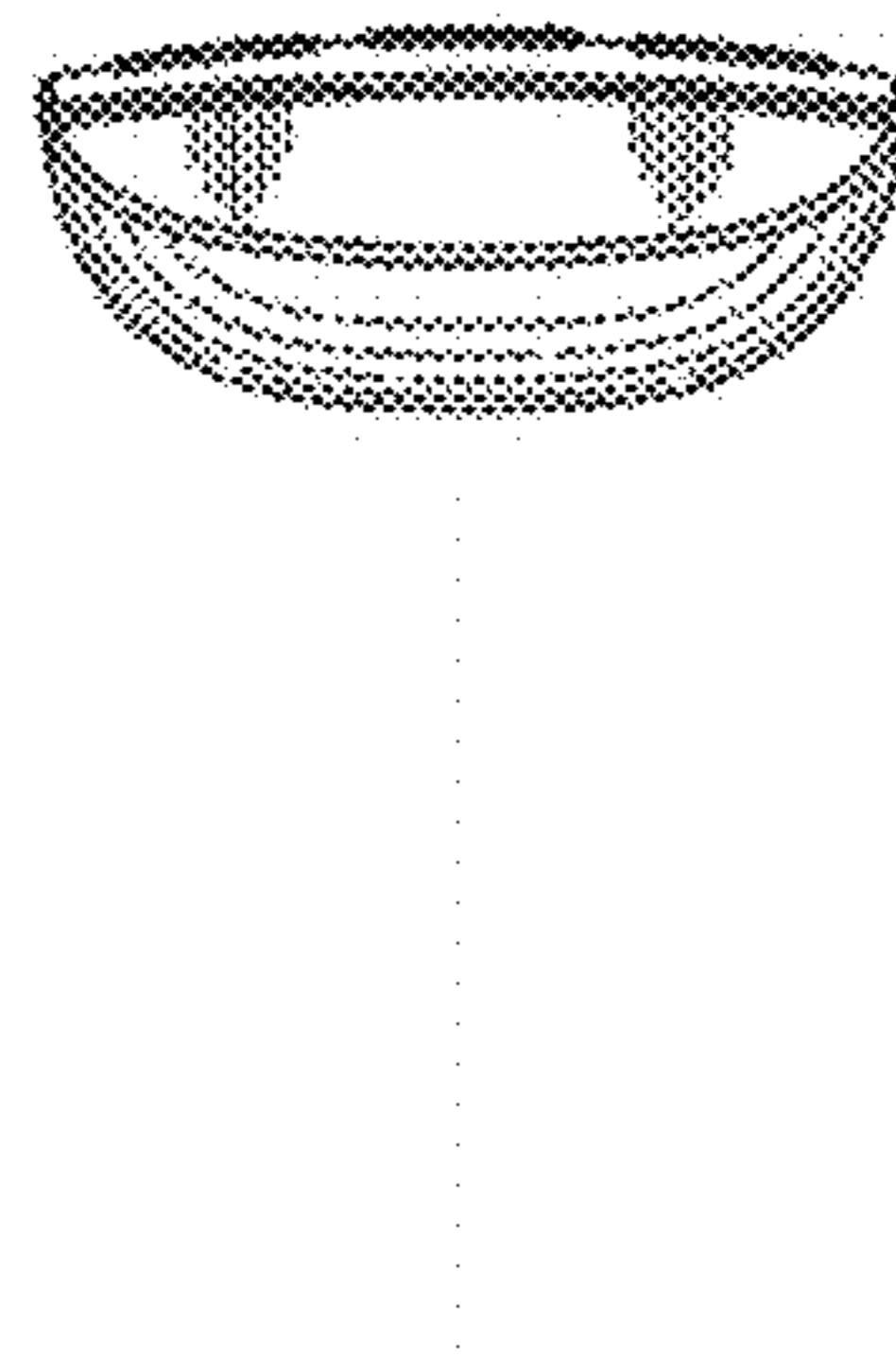

4.1

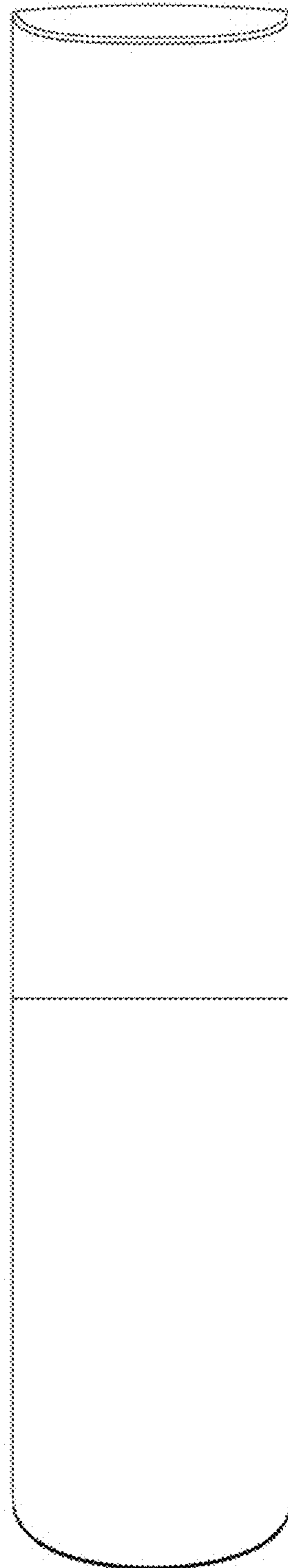

4.2

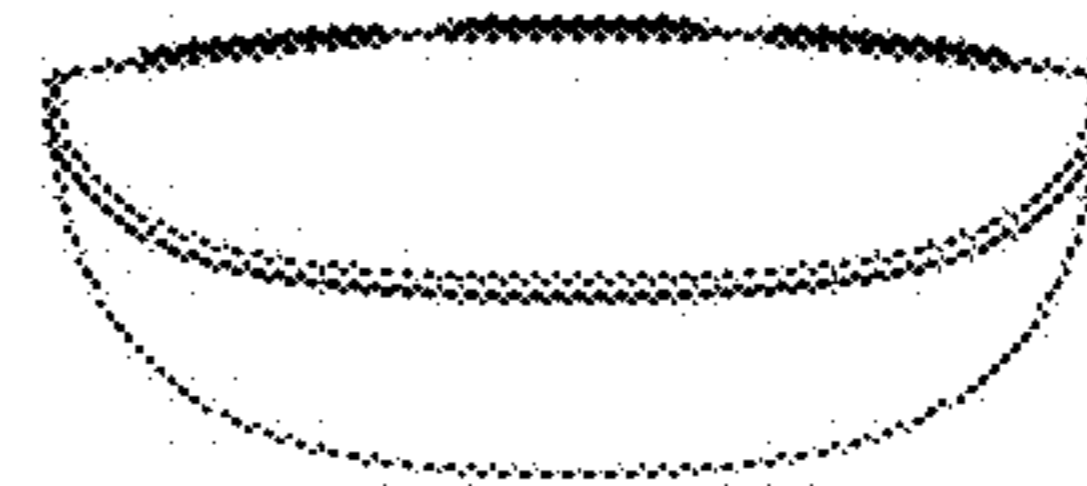

4.3

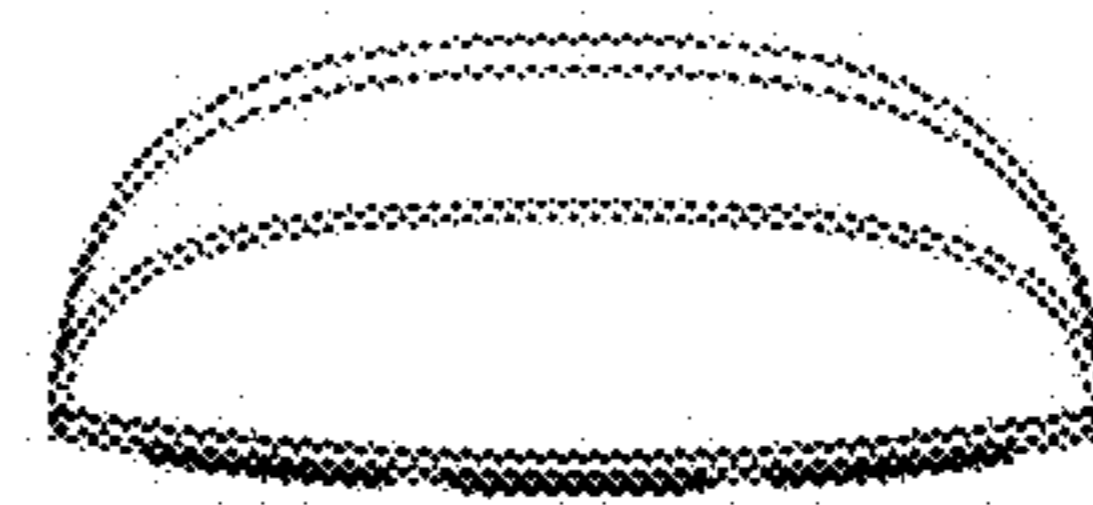

4.4

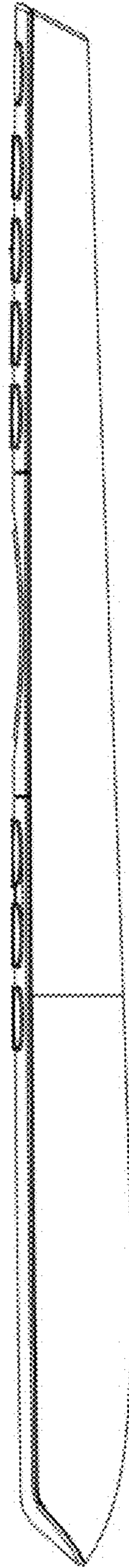

4.5

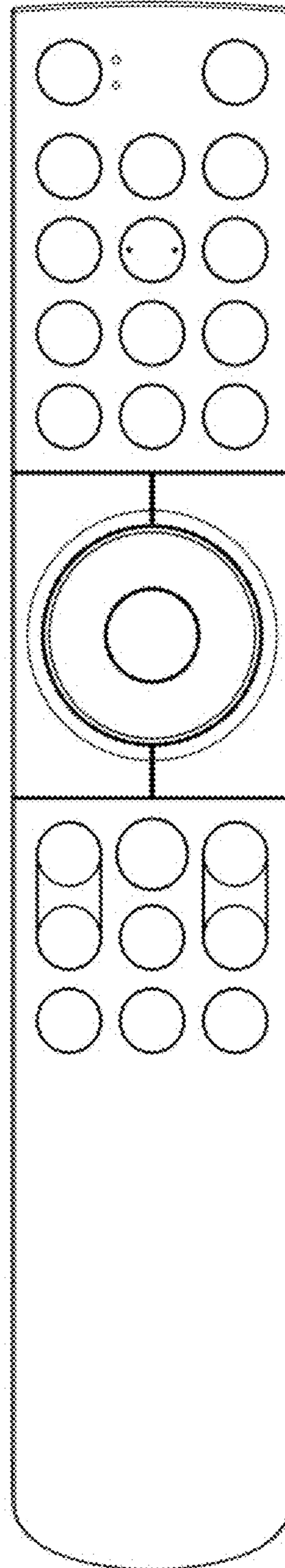

4.6

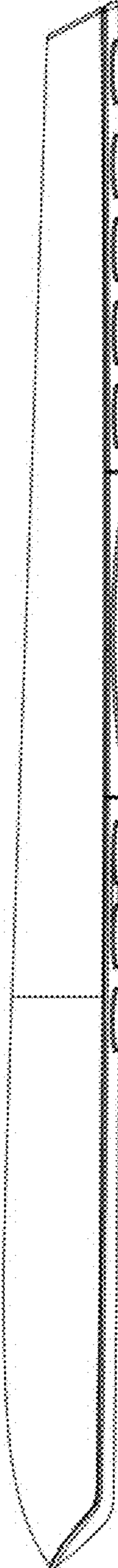

4.7

