



US00D901441S

(12) **United States Design Patent** (10) **Patent No.:** **US D901,441 S**
Huang et al. (45) **Date of Patent:** **** Nov. 10, 2020**

(54) **SPEAKER BOX**
(71) Applicant: **BEIJING XIAOMI MOBILE SOFTWARE CO., LTD.**, Beijing (CN)
(72) Inventors: **Siyu Huang**, Beijing (CN); **Hao Jiang**, Beijing (CN)
(73) Assignee: **BEIJING XIAOMI MOBILE SOFTWARE CO., LTD.**, Beijing (CN)

D576,486 S * 9/2008 Koza D9/432
D618,232 S * 6/2010 O'Neil D14/314
D646,665 S * 10/2011 Iijima D14/214
D647,866 S * 11/2011 Chen D14/125
D650,377 S * 12/2011 Akana D14/314
D692,849 S * 11/2013 Choi D14/188
D695,711 S * 12/2013 Szymanski D14/214
D707,202 S * 6/2014 McManigal D14/214

(Continued)

(**) Term: **15 Years**

FOREIGN PATENT DOCUMENTS

(21) Appl. No.: **35/505,786**

KR 301000377.0000 * 3/2019
WO D102963-001 * 2/2018

(22) Filed: **May 17, 2018**

(80) **Hague Agreement Data**

Int. Filing Date: **May 17, 2018**
Int. Reg. No.: **DM/102963**
Int. Reg. Date: **May 17, 2018**
Int. Reg. Pub. Date: **Oct. 5, 2018**

OTHER PUBLICATIONS

Xiaomi Mi AI Speaker Mini Review, announced Mar. 29, 2018 [online], [retrieved Jul. 16, 2019]. Available from Internet, URL: <<https://www.youtube.com/watch?v=iy6NhiNbLPs>> (Year: 2018).*

(Continued)

(30) **Foreign Application Priority Data**

Nov. 17, 2017 (CN) 2017 3 0570085

Primary Examiner — Dana K Weiland

(74) *Attorney, Agent, or Firm* — Dickinson Wright PLLC

(51) **LOC (12) Cl.** **14-01**

(52) **U.S. Cl.**
USPC **D14/214**

(57) **CLAIM**

The ornamental design for a speaker box, as shown and described.

(58) **Field of Classification Search**

USPC D14/204, 205, 206, 210–216, 221, 239, D14/249, 265, 209.1, 203.8, 253, 447, D14/192, 223, 224, 199, 372, 225, 226; D21/513, 516; D26/93; D29/112
CPC . B60R 11/0217; B60R 11/0223; H04R 1/023; H04R 1/025; H04R 1/323; H04R 5/02; H04R 19/02; H04R 2400/00; H04R 2400/07; H04R 2400/11; G06F 1/16

DESCRIPTION

See application file for complete search history.

1.1 is a front elevation view of a speaker box showing our new design;
1.2 is a back elevation view thereof;
1.3 is a left side elevation view thereof;
1.4 is a right side elevation view thereof;
1.5 is a top plan view thereof;
1.6 is a bottom plan view thereof; and,
1.7 is a perspective view thereof.

The broken lines shown in the drawings depict portions of the speaker box that form no part of the claimed design.

(56) **References Cited**

U.S. PATENT DOCUMENTS

D526,640 S * 8/2006 Chin D14/188
D576,053 S * 9/2008 Lulic D10/24

1 Claim, 7 Drawing Sheets

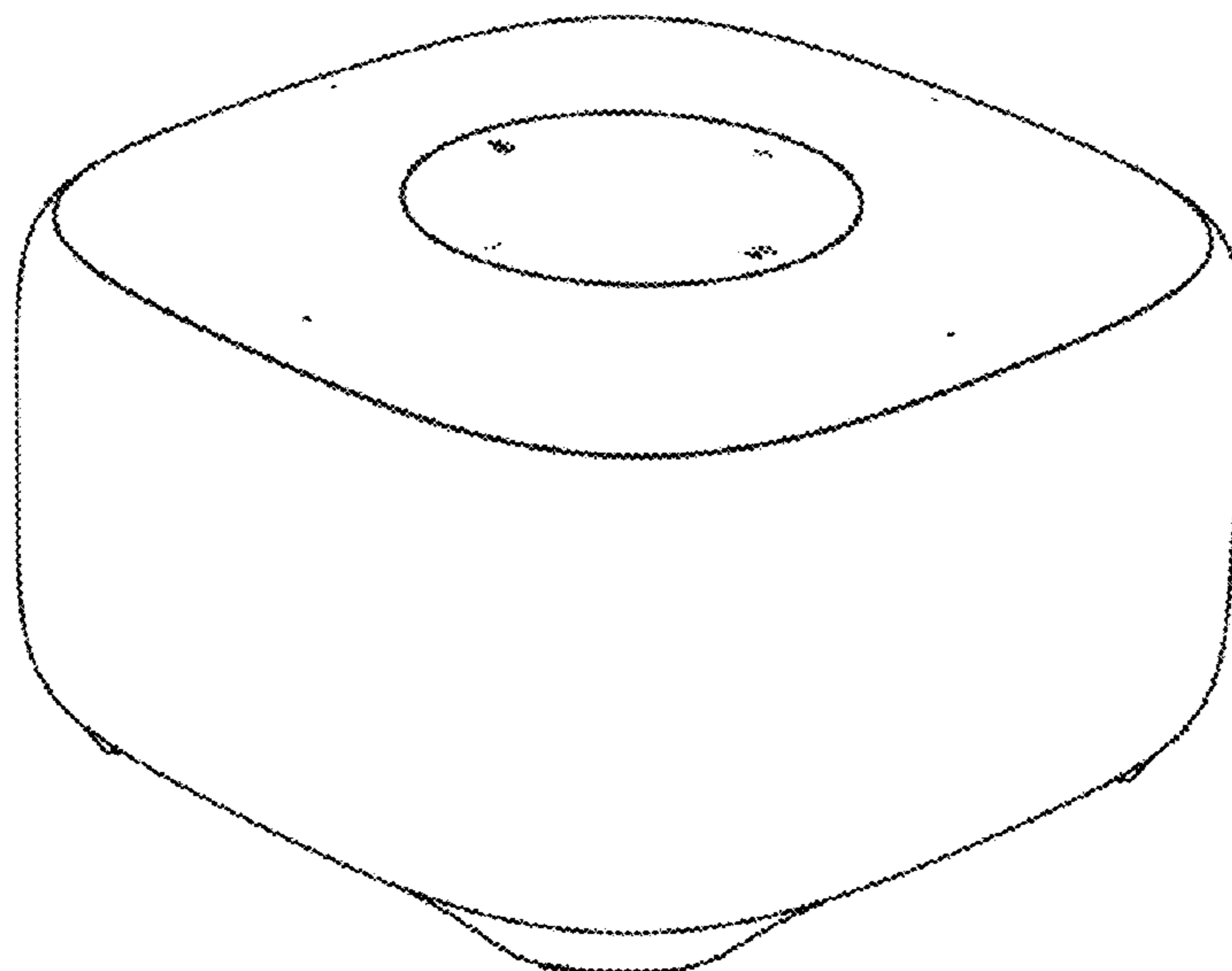

(56)

References Cited

U.S. PATENT DOCUMENTS

D714,249 S * 9/2014 Carney D14/140
 D718,739 S * 12/2014 DiTullo D14/214
 D724,563 S * 3/2015 Kim D14/214
 D725,624 S * 3/2015 Carney D14/140
 D726,682 S * 4/2015 Kim D14/170
 D736,186 S * 8/2015 Kauppila D14/225
 D740,262 S * 10/2015 Hasegawa D14/240
 D754,109 S * 4/2016 Kelly D14/240
 D758,345 S * 6/2016 Fujioka D14/214
 D768,607 S * 10/2016 Altonen D14/240
 D771,593 S * 11/2016 Koo D14/214
 D782,429 S * 3/2017 Xianda D14/125
 D786,218 S * 5/2017 Tan D14/215
 D799,588 S * 10/2017 Nanno D18/19
 D800,697 S * 10/2017 Fischer D14/214
 D813,192 S * 3/2018 Zeng D14/204
 D824,349 S * 7/2018 Kim D14/125
 D826,206 S * 8/2018 Elmieh D14/204

D830,343 S * 10/2018 Fustino D14/214
 D835,068 S * 12/2018 Chen D14/214
 D836,610 S * 12/2018 Yoon D14/216
 D842,265 S * 3/2019 Becker D14/204
 D844,587 S * 4/2019 Lu D14/214
 D851,621 S * 6/2019 Demin D14/204
 D859,415 S * 9/2019 Liao D14/434
 D865,716 S * 11/2019 Kuang D14/216

OTHER PUBLICATIONS

Xiaomi Mi AI Mini Speaker, announced Mar. 30, 2018 [online], [retrieved Jul. 16, 2019]. Available from Internet, URL: <https://www.gearbest.com/speakers/pp_1699226.html> (Year: 2018).*
 Philips Hue White LED Smart Light Bulb Starter Kit, announced Jul. 1, 2019 [online], [retrieved Jul. 16, 2019]. Available from Internet, URL: <https://www.amazon.com/Philips-Hue-Starter-HomeKit-Assistant/dp/B07QZHMM4P?ref=Oct_DLandingS_PC_29b0a6ff_5&smid=ATVPDKIKX0DER&pldnSite=1> (Year: 2019).*

* cited by examiner

1.1

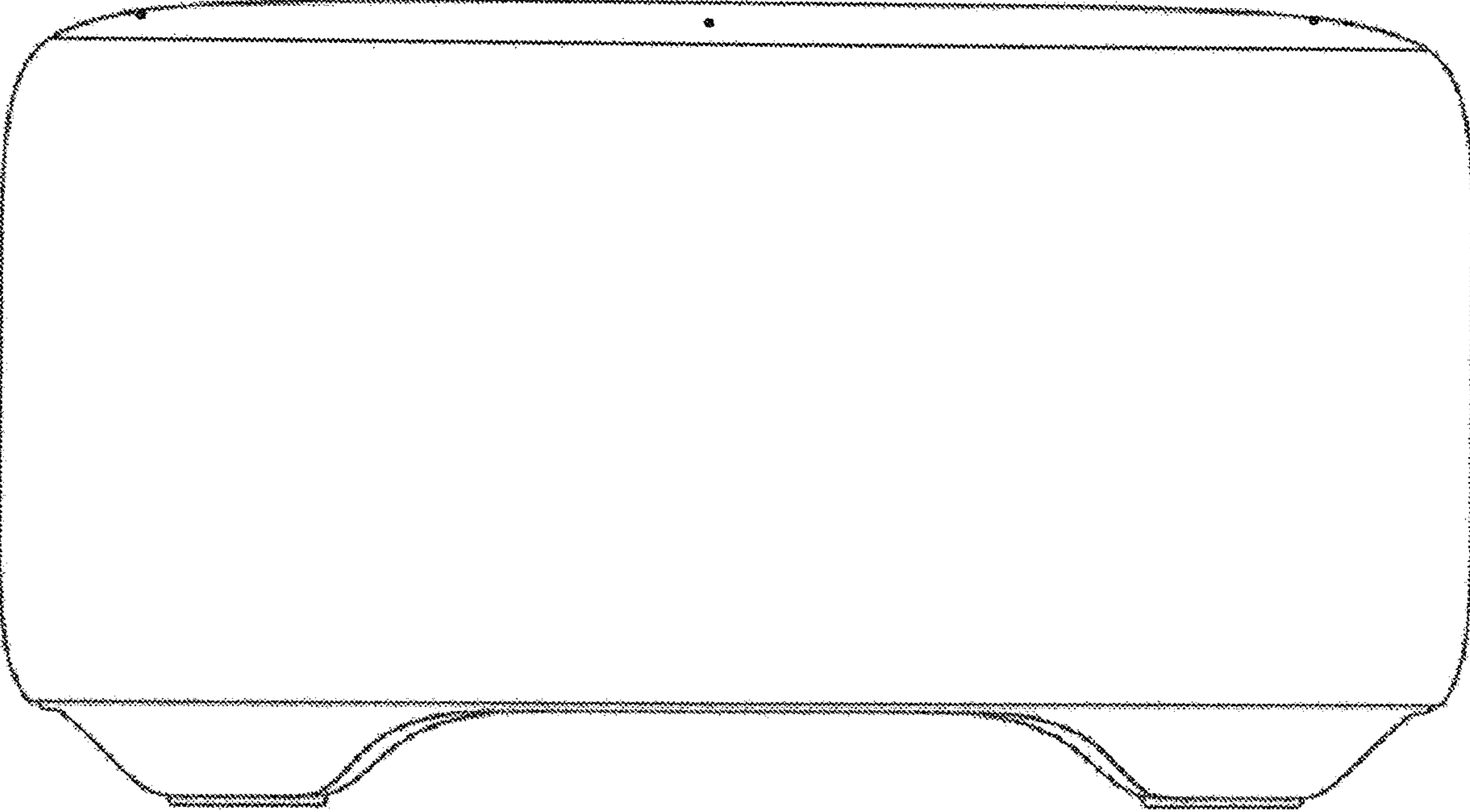

1.2

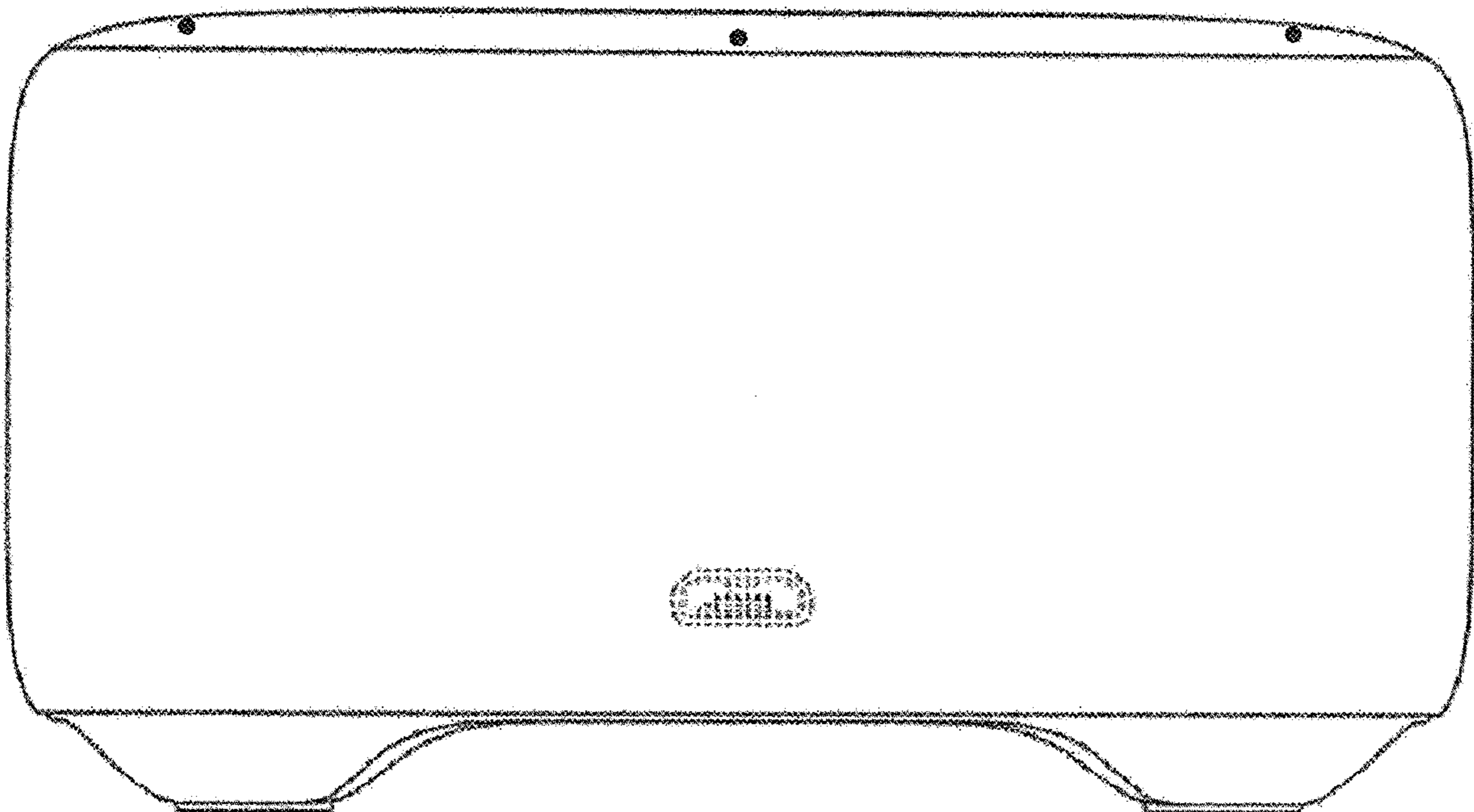

1.3

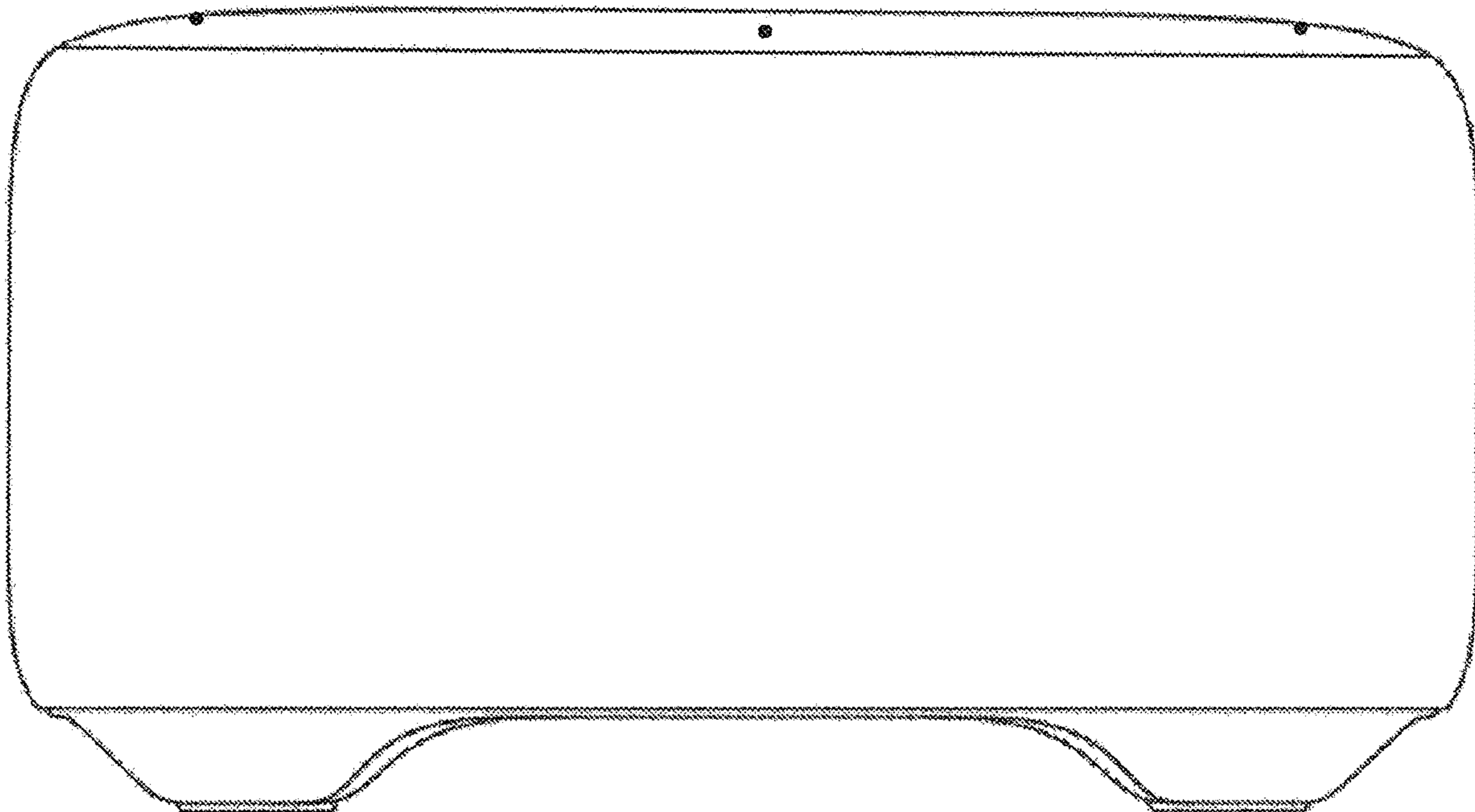

1.4

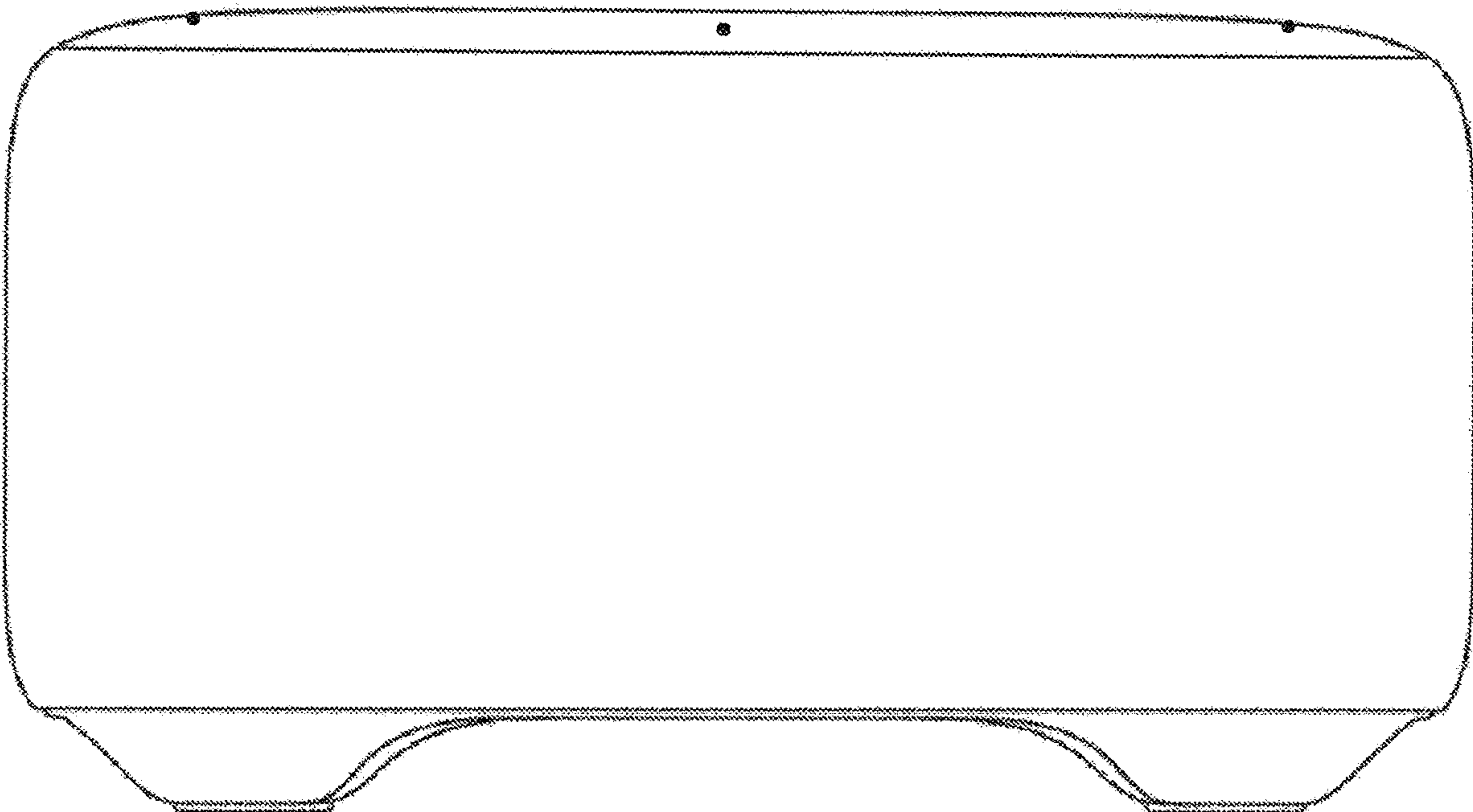

1.5

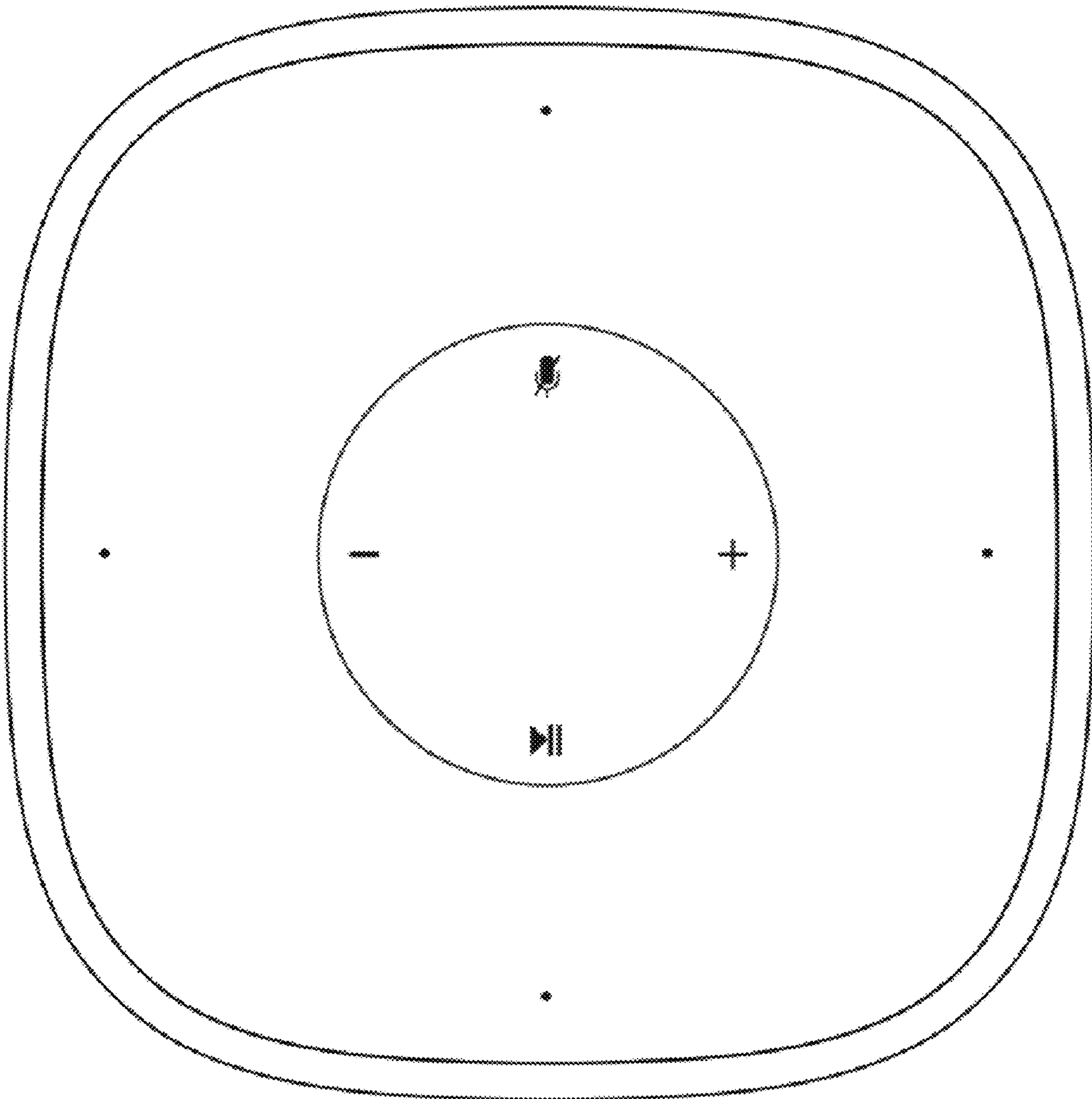

1.6

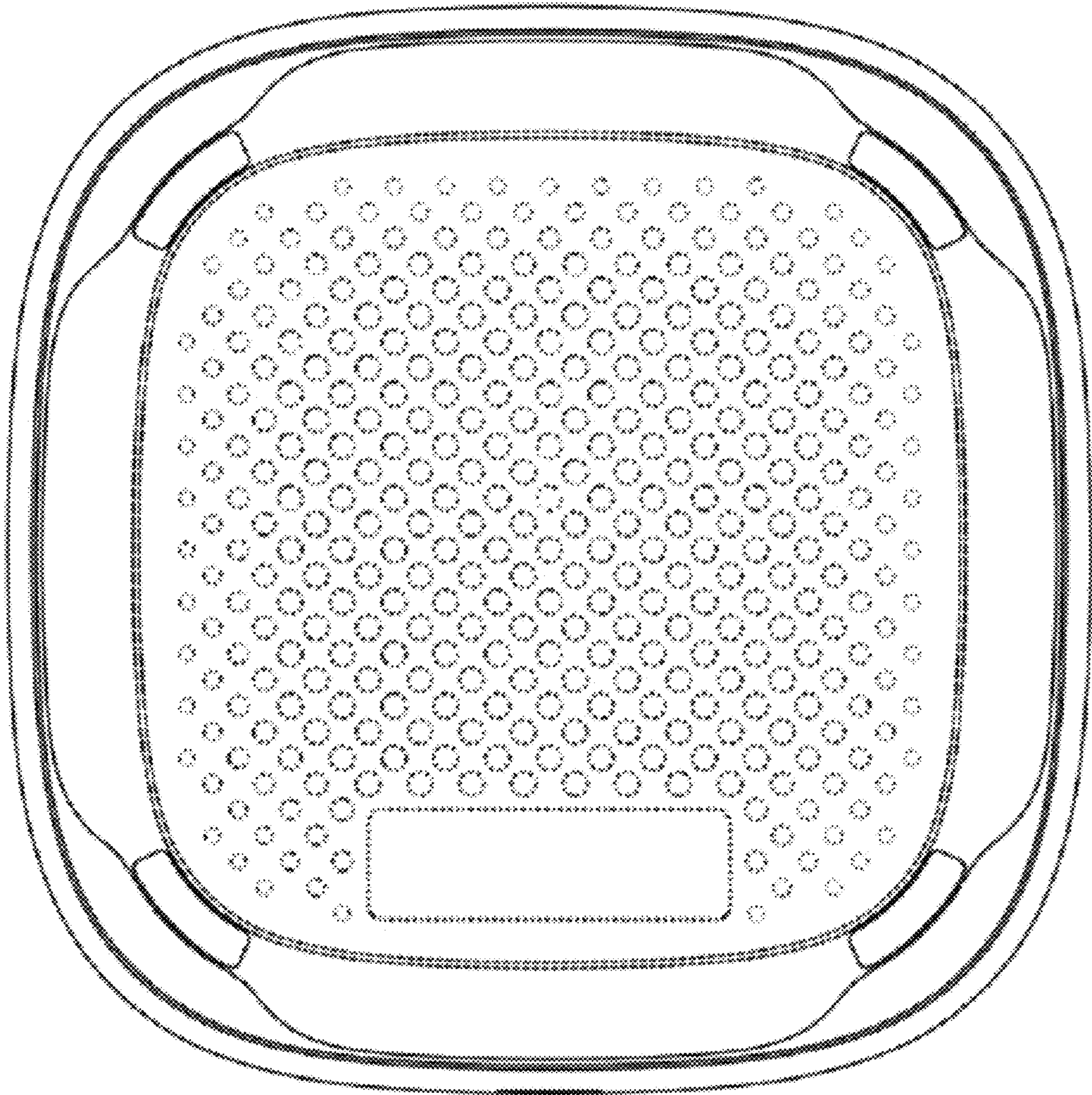

1.7

