



US00D901381S

(12) **United States Design Patent** (10) **Patent No.:** **US D901,381 S**
Choo et al. (45) **Date of Patent:** **** Nov. 10, 2020**

(54) **CHARGER FOR MOBILE DEVICE**
(71) Applicant: **SPIGEN KOREA CO., LTD.**, Seoul (KR)
(72) Inventors: **Eugene Kim Choo**, Seoul (KR); **Namheui Jung**, Seoul (KR)
(73) Assignee: **Spigen Korea CO., LTD.**, Seoul (KR)
(**) Term: **15 Years**

D713,786 S * 9/2014 Wen D13/103
D733,043 S 6/2015 Hasbrook et al.
D740,223 S 10/2015 Yoneta
D760,647 S * 7/2016 Chen D13/103
D762,170 S * 7/2016 Lei D13/108
D763,185 S * 8/2016 Wen D13/103
D769,185 S 10/2016 Lee et al.
D780,116 S 2/2017 Bing
D787,443 S * 5/2017 Chiang D13/110
D788,037 S * 5/2017 Hung D13/110
(Continued)

(21) Appl. No.: **29/715,631**
(22) Filed: **Dec. 3, 2019**
(51) **LOC (12) Cl.** **13-02**
(52) **U.S. Cl.**
USPC **D13/108**; D13/103
(58) **Field of Classification Search**
USPC D13/103, 107-108, 110, 184, 199
CPC H02J 7/0044; H02J 7/0045; H02J 7/0042;
H02J 7/342; H02J 7/345; H02J 7/025;
H02J 7/0007; H02J 7/0027
See application file for complete search history.

OTHER PUBLICATIONS

“Yoobao 20000mAh Power Bank Portable Phone Charger External Battery Pack Backup Charger (3- Input, Dual-Output, Digital Display) Compatible iPhone Xs/X/8/7, iPad, Samsung Galaxy Cell-phone & More -Black”, <https://www.amazon.com/Yoobao-20000mAh-Power-Bank-Portable/dp/B07J3BN855>, Earliest review date of Sep. 26, 2017, downloaded Jun. 25, 2020.

(Continued)

Primary Examiner — Rosemary K Tarcza
(74) *Attorney, Agent, or Firm* — Heedong Chae; Lucem, PC

(56) **References Cited**
U.S. PATENT DOCUMENTS

5,179,501 A * 1/1993 Ocken H05K 1/0278
174/254
D471,514 S 3/2003 Jacober et al.
D490,412 S 5/2004 Sheu
D520,502 S 5/2006 Xu et al.
D565,571 S * 4/2008 Trifilio D14/356
D601,961 S * 10/2009 Mahaffey D13/110
D609,226 S 2/2010 Hofer et al.
D617,268 S 6/2010 Yen
D622,716 S 8/2010 Andre et al.
D643,807 S 8/2011 Jiang
D656,093 S 3/2012 Nomi et al.
D661,248 S 6/2012 Fahrendorff et al.
D676,380 S * 2/2013 Sun D13/108
D705,782 S 5/2014 McParland et al.

(57) **CLAIM**

The ornamental design for a charger for mobile device, as shown and described.

DESCRIPTION

FIG. 1 is a front perspective view of a charger for mobile device showing my new design;
FIG. 2 is a rear perspective view thereof;
FIG. 3 is a front elevational view thereof;
FIG. 4 is a rear elevational view thereof;
FIG. 5 is a left side elevational view thereof;
FIG. 6 is a right side elevational view thereof;
FIG. 7 is a top plan view thereof; and,
FIG. 8 is a bottom plan view thereof.

1 Claim, 8 Drawing Sheets

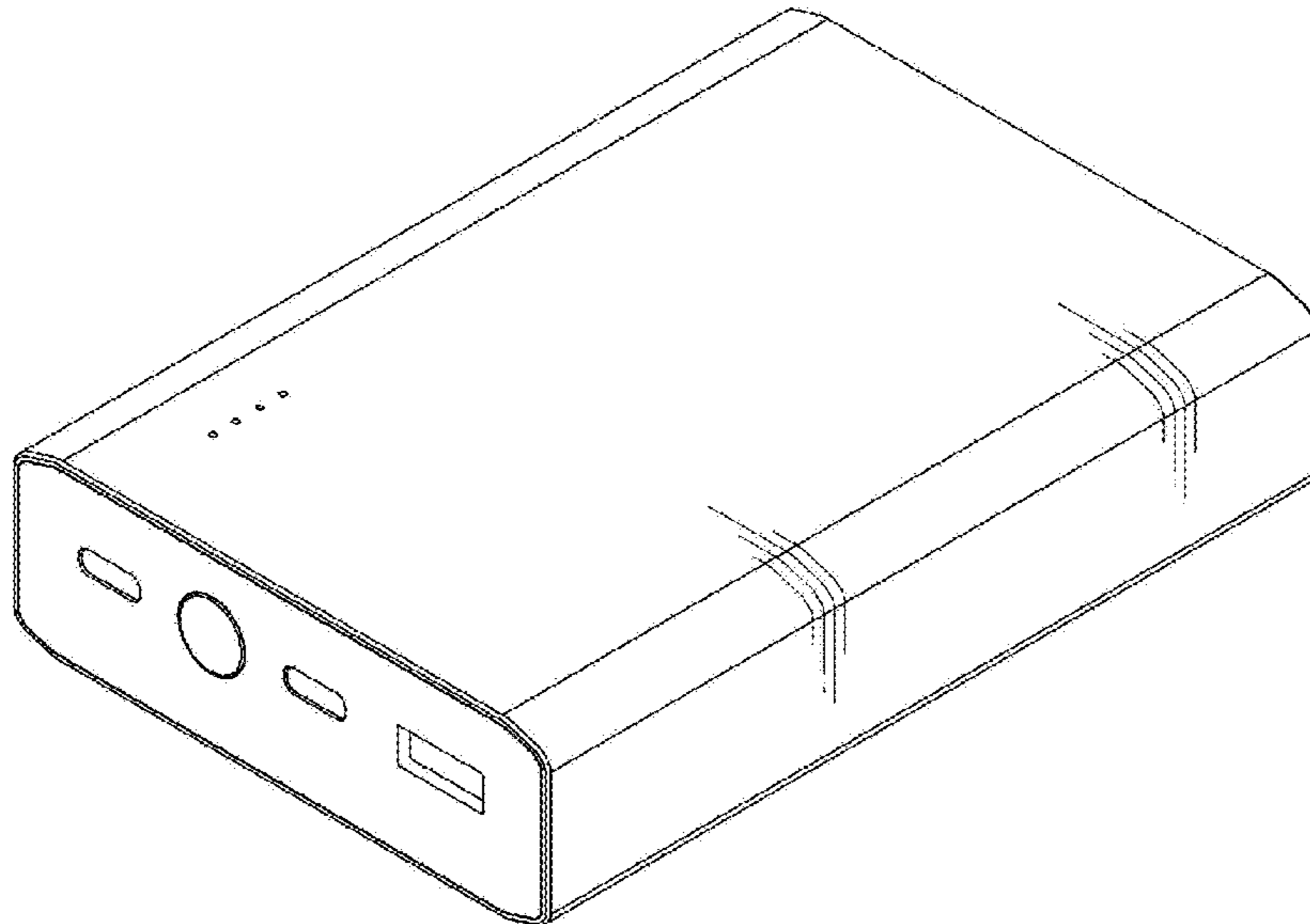

(56)

References Cited

U.S. PATENT DOCUMENTS

D791,070 S	*	7/2017	Son	D13/103
D793,958 S		8/2017	Rautiainen		
D795,874 S		8/2017	Szeremeta et al.		
D796,433 S		9/2017	Langhammer et al.		
D796,434 S		9/2017	Li		
D797,043 S		9/2017	Akana et al.		
D797,044 S	*	9/2017	Miller	D13/108
D798,811 S	*	10/2017	Liao	D13/110
D803,779 S	*	11/2017	Jung	D13/107
D805,493 S		12/2017	Chang et al.		
D807,401 S		1/2018	Xu		
D812,000 S	*	3/2018	Li	D13/108
D812,560 S		3/2018	Xu		
D814,405 S		4/2018	Hahn		
D815,038 S		4/2018	Park et al.		
D816,029 S		4/2018	Dai		
D816,070 S		4/2018	Marzynski et al.		
D816,607 S		5/2018	Roberts		
D817,269 S		5/2018	Sukphist et al.		
D824,328 S	*	7/2018	Liu	D13/108
D826,854 S		8/2018	Roberts		
D827,569 S		9/2018	Roberts		
D832,208 S		10/2018	Grois		
D836,546 S		12/2018	Kang		
D838,241 S		1/2019	Xie		
D842,244 S	*	3/2019	Li	D13/108
D844,560 S	*	4/2019	Miller	D13/108
D861,597 S	*	10/2019	Gan	D13/108
D864,905 S		10/2019	Roberts		
D871,324 S	*	12/2019	Roberts	D13/108
D871,329 S	*	12/2019	Chen	D13/108
D885,327 S	*	5/2020	Leeds-Frank	D13/103

OTHER PUBLICATIONS

“Bonai Portable Charger 30000mAh, (Huge Capacity)(Flashlight)(Outdoor) 5.6A Output External Battery Pack, 4A Input High-Speed Charging Technology, Power Bank Compatible with iPhone iPad Samsung-Black”, <https://www.amazon.com/Bonai-Flashlight-High-Speed-Technology-Samsung-Black/dp/B07HQJSSDR>, Earliest review date of Nov. 7, 2017, downloaded Jun. 25, 2020.

“MyCharge AdventureMax Portable Charger 10500mAh Rugged External Battery Pack with Built-in Carabiner Clip and Dual USB

Ports for Smartphones, Tablets and USB Devices (iPhone, iPad, Samsung Galaxy)”, <https://www.amazon.com/myCharge-AdventureMax-Portable-Carabiner-Smartphones/dp/B075MRV8ZC>, Earliest review date of Feb. 21, 2018, downloaded Jun. 25, 2020.

“MyCharge Adventureplus Portable Charger 6700mAh Rugged External Battery Pack with Built-in Carabiner Clip and Dual USB Ports for Smartphones, Tablets and USB Devices (iPhone, iPad, Samsung Galaxy)”, <https://www.amazon.com/myCharge-AdventurePlus-Portable-Carabiner-Smartphones/dp/B072K5SSY4>, Earliest review date of Feb. 21, 2018, downloaded Jun. 25, 2020.

“Halo Bolt 58830 mWh Portable Phone Laptop Charger Car Jump Starter with AC Outlet and Car Charger—Grey”, <https://www.amazon.com/dp/B079FSPRXM>, Earliest review date of May 20, 2018, downloaded Jun. 25, 2020.

“Bonai Portable Charger 30000mAh, (Huge Capacity)(Flashlight)(Outdoor) 5.6A Output External Battery Pack, 4A Input High-Speed Charging Technology, Power Bank Compatible with iPhone iPad Samsung-Black”, <https://www.amazon.com/Bonai-Flashlight-High-Speed-Technology-Samsung-Black/dp/B07HQJSSDR>, Earliest review date of Nov. 7, 2018, downloaded Jun. 25, 2020.

“Portable Charger Power Bank Battery—by TalkWorks | 6000 mAh | Cell Phone Backup External Dual USB Power Jack for Apple iPhone 11, XR, XS, X, 8, 7, 6, iPad & Android for Samsung Galaxy—Silver”, <https://www.amazon.com/Portable-Charger-Power-Bank-Battery/dp/B07L15SJZQ>, Earliest review date of Feb. 14, 2019, downloaded Jun. 25, 2020.

“Krisdonia AC Outlet Portable Laptop Charger (TSA-Approved) 27000mAh 130W Travel Laptop Power Bank & External Battery Pack for MacBook, Laptop and More”, <https://www.amazon.com/dp/B07R8Y24PB>, Earliest review date of Jun.20, 2019, downloaded Jun. 25, 2020.

“Portable Charger RAVPower 10000mAh Power Bank Dual USB Ports Battery Pack Ultra Slim Total 3.4A iSmart Output Charger Light External Battery Pack Compatible with iPhone Samsung Galaxy and More”, <https://www.amazon.com/Portable-RAVPower-10000mAh-External-Compatible/dp/B07VL4H3Y5>, Earliest review date of Aug. 22, 2019, downloaded Jun. 25, 2020.

“Portable Charger 26800mAh, 18W USB-C Power Delivery Power Bank External Battery Pack for iPhone 11/11 Pro/11 Pro Max/XS/XR, Galaxy S10/S9/Note 9/8, Pixel 3/3XL, iPad Pro 2018 and More”, <https://www.amazon.com/portable-Charger-26800mAh-Delivery-External/dp/B07YDLT34Y>, Earliest review date of Nov. 23, 2019, downloaded Jun. 25, 2020.

* cited by examiner

FIG. 1

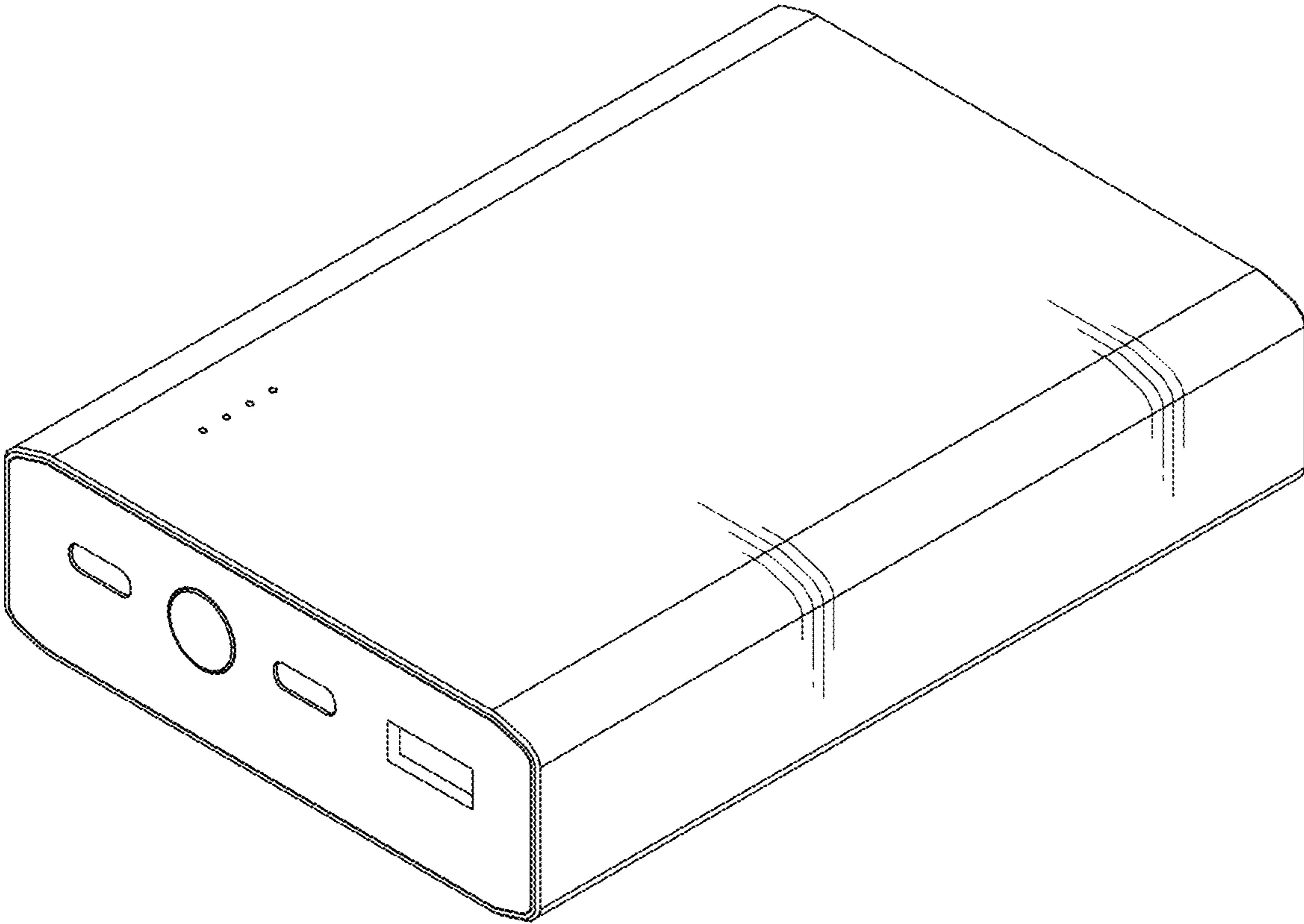

FIG. 2

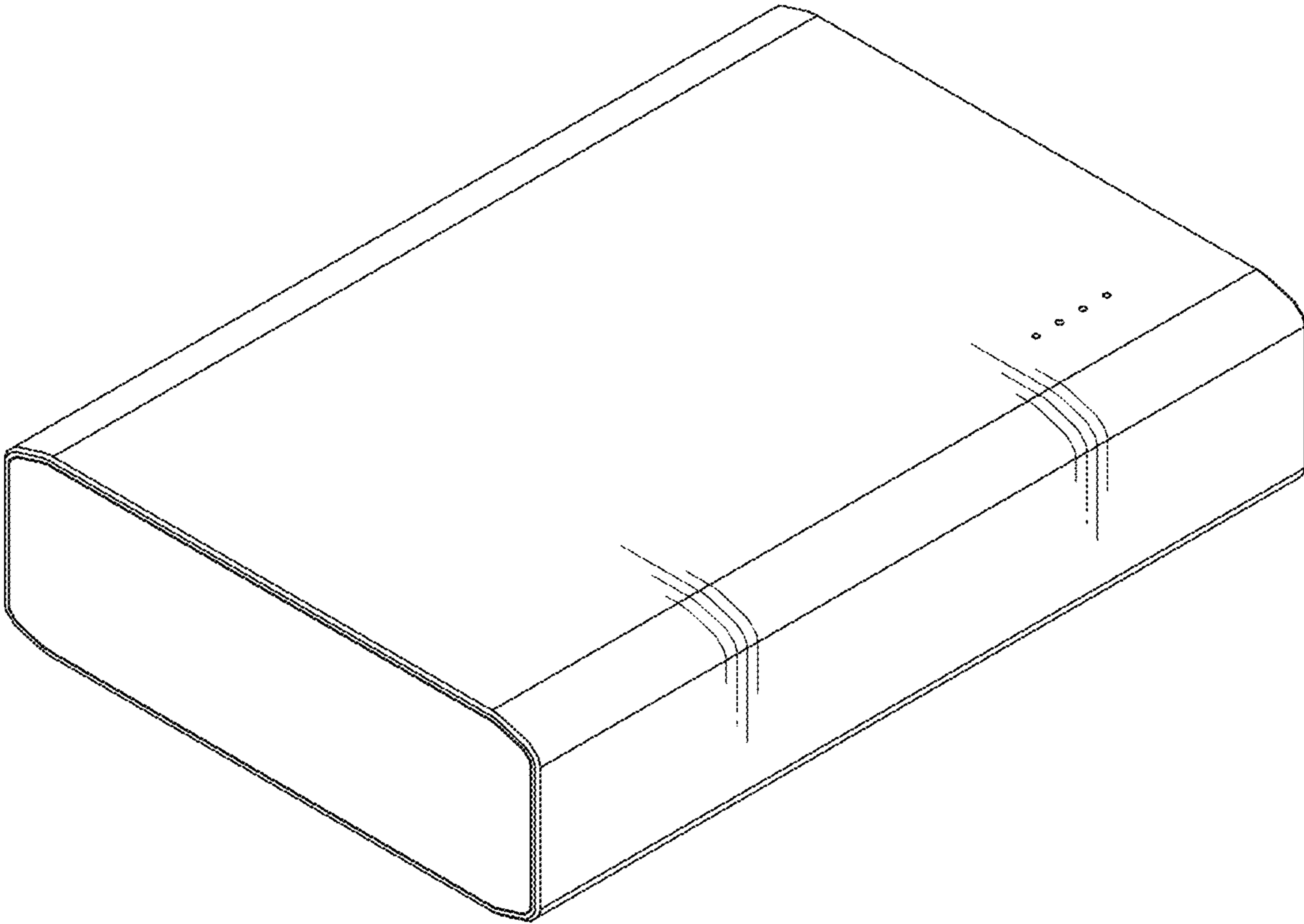

FIG. 3

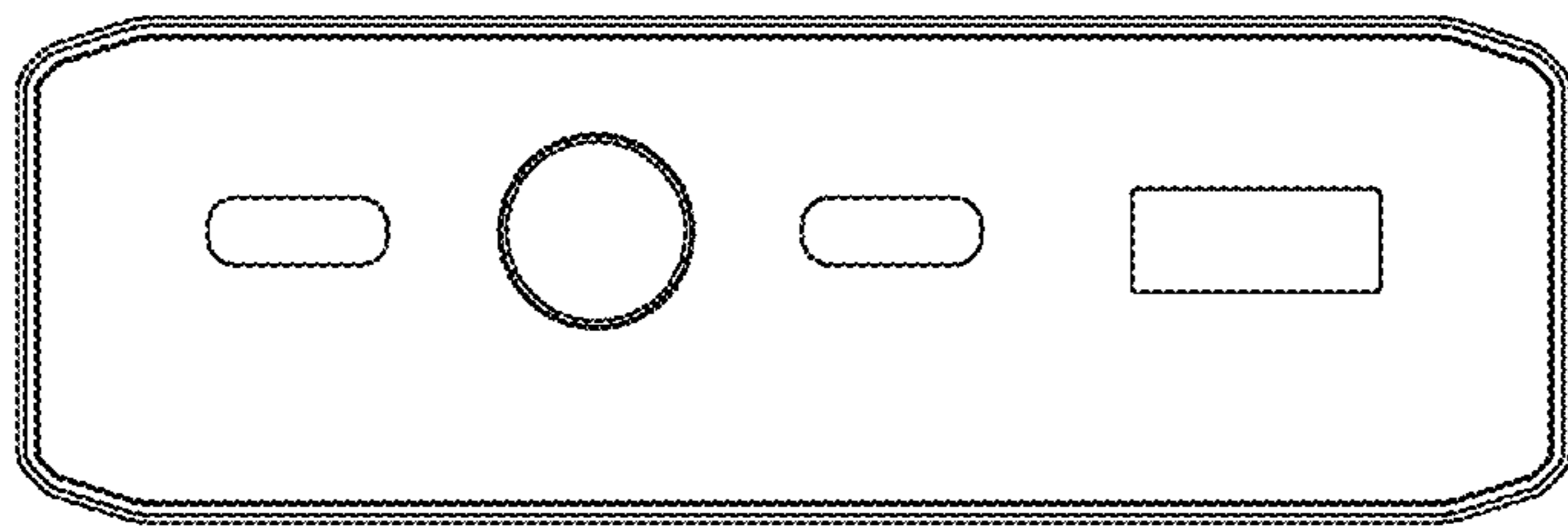

FIG. 4



FIG. 5

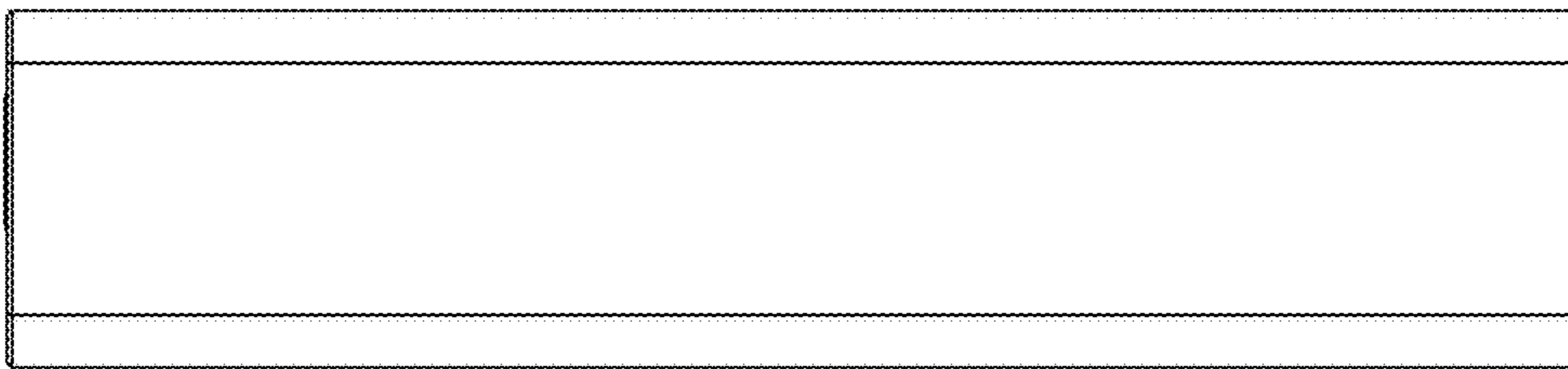

FIG. 6

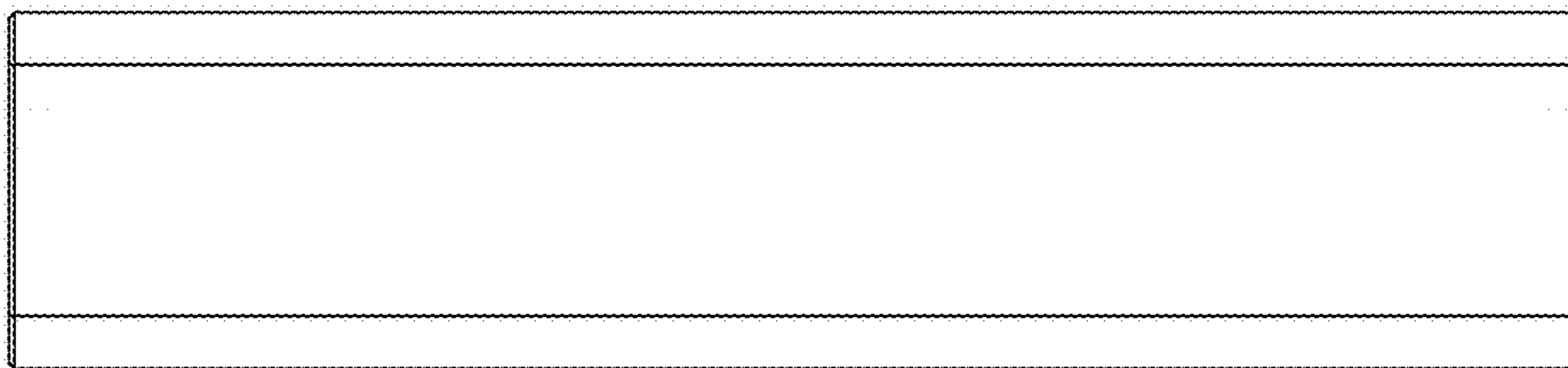

FIG. 7

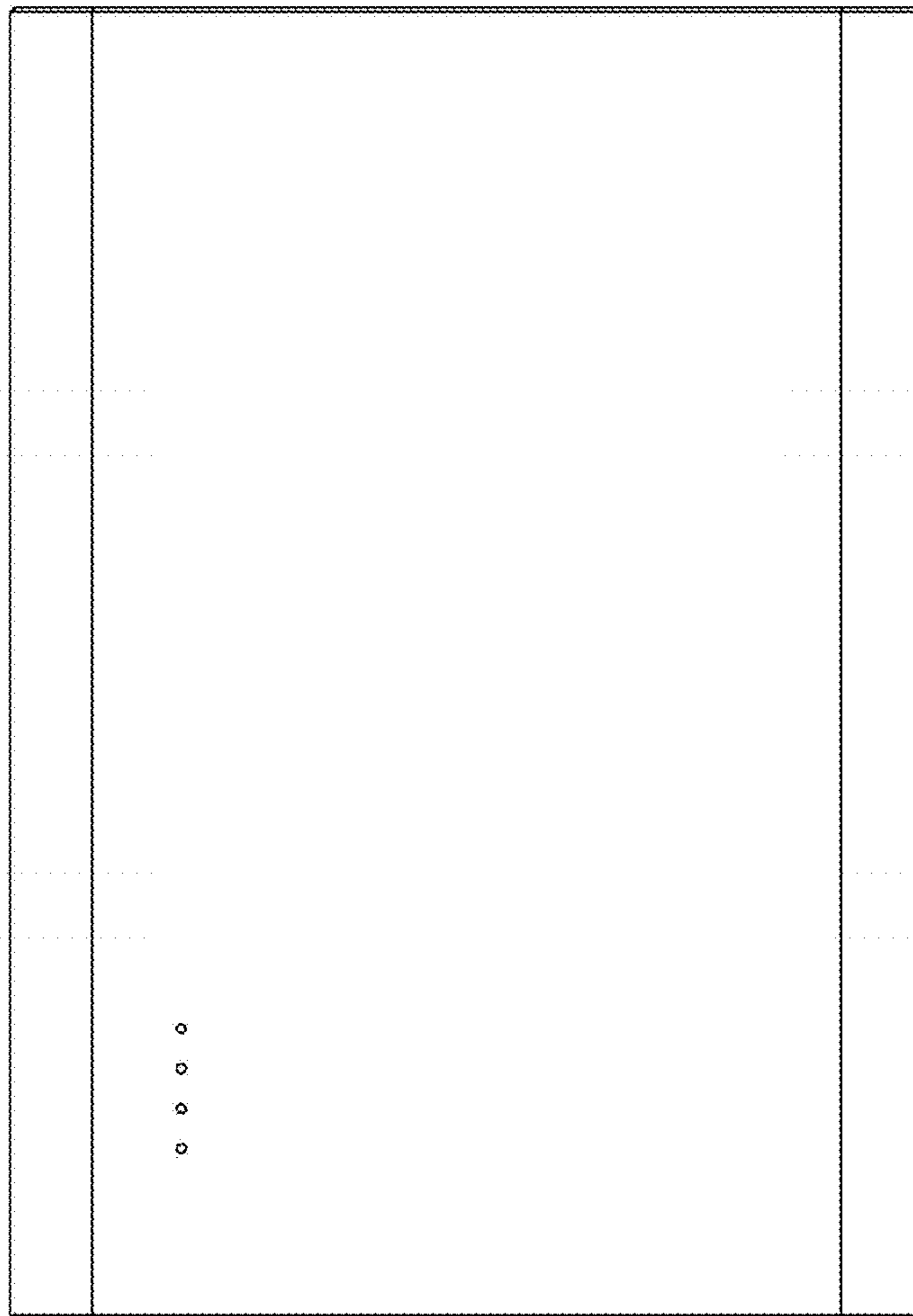

FIG. 8

