



US00D901203S

(12) **United States Design Patent** (10) **Patent No.:** **US D901,203 S**
Davis et al. (45) **Date of Patent:** **** Nov. 10, 2020**

(54) **PATIO CHAIR**
(71) Applicant: **WALKER EDISON FURNITURE COMPANY LLC**, Salt Lake City, UT (US)

2,697,481 A 12/1954 Zoercher
D196,575 S 10/1963 Ritts
3,527,498 A 9/1970 Werner
4,762,362 A 9/1988 Brunn
(Continued)

(72) Inventors: **Matthew Davis**, Millcreek, UT (US);
Brad Bonham, Draper, UT (US);
Richard A. Packer, Kaysville, UT (US); **Tiffany Duhadway**, Salt Lake City, UT (US)

FOREIGN PATENT DOCUMENTS

CA 188875 2/1919
CA 705704 3/1995
(Continued)

(73) Assignee: **WALKER EDISON FURNITURE COMPANY LLC**, West Jordan, UT (US)

OTHER PUBLICATIONS

“Dark Brown Skoog Outdoor Chevron Rocking Chair” Apr. 28, 2019, wayfair.com, site visited Jul. 31, 2020 <<https://www.wayfair.com/outdoor/pdx/breakwater-bay-skoog-outdoor-chevron-rocking-chair-w003129885.html>> (Year: 2019).*

(**) Term: **15 Years**

(Continued)

(21) Appl. No.: **29/699,083**

Primary Examiner — Kevin K Rudzinski

(22) Filed: **Jul. 23, 2019**

Assistant Examiner — Paul D Bohannon

(51) **LOC (12) Cl.** **06-01**

(74) *Attorney, Agent, or Firm* — Workman Nydegger

(52) **U.S. Cl.**

USPC **D6/370**

(58) **Field of Classification Search**

USPC D6/370, 371, 373, 374, 376, 379, 380, D6/381; D21/521

CPC A47C 3/00; A47C 4/08; A47C 4/00; A47C 7/70; A47C 7/405; A47C 13/00; A47B 83/02; A47B 83/023; A47B 83/024; A47B 85/04

See application file for complete search history.

(57) **CLAIM**

The ornamental design for a patio chair, as shown and described.

DESCRIPTION

FIG. 1 is a front perspective view of a patio chair showing the new design;
FIG. 2 is a front elevation view thereof;
FIG. 3 is a back elevation view thereof;
FIG. 4 is a top plan view thereof;
FIG. 5 is a bottom plan view thereof;
FIG. 6 is a right elevation view thereof; and,
FIG. 7 is a left elevation view thereof.
The broken lines in the drawings are for the purpose of illustrating portions of the article that form no part of the claimed design.

(56) **References Cited**

U.S. PATENT DOCUMENTS

107,455 A 9/1870 Coolidge
1,341,050 A 5/1920 Evangelist
1,686,599 A 10/1928 Potter
D102,695 S 1/1937 Molellan
D111,906 S 10/1938 Davis
D156,835 S 1/1950 Noneill
2,669,295 A 2/1954 Shepherdson

1 Claim, 4 Drawing Sheets

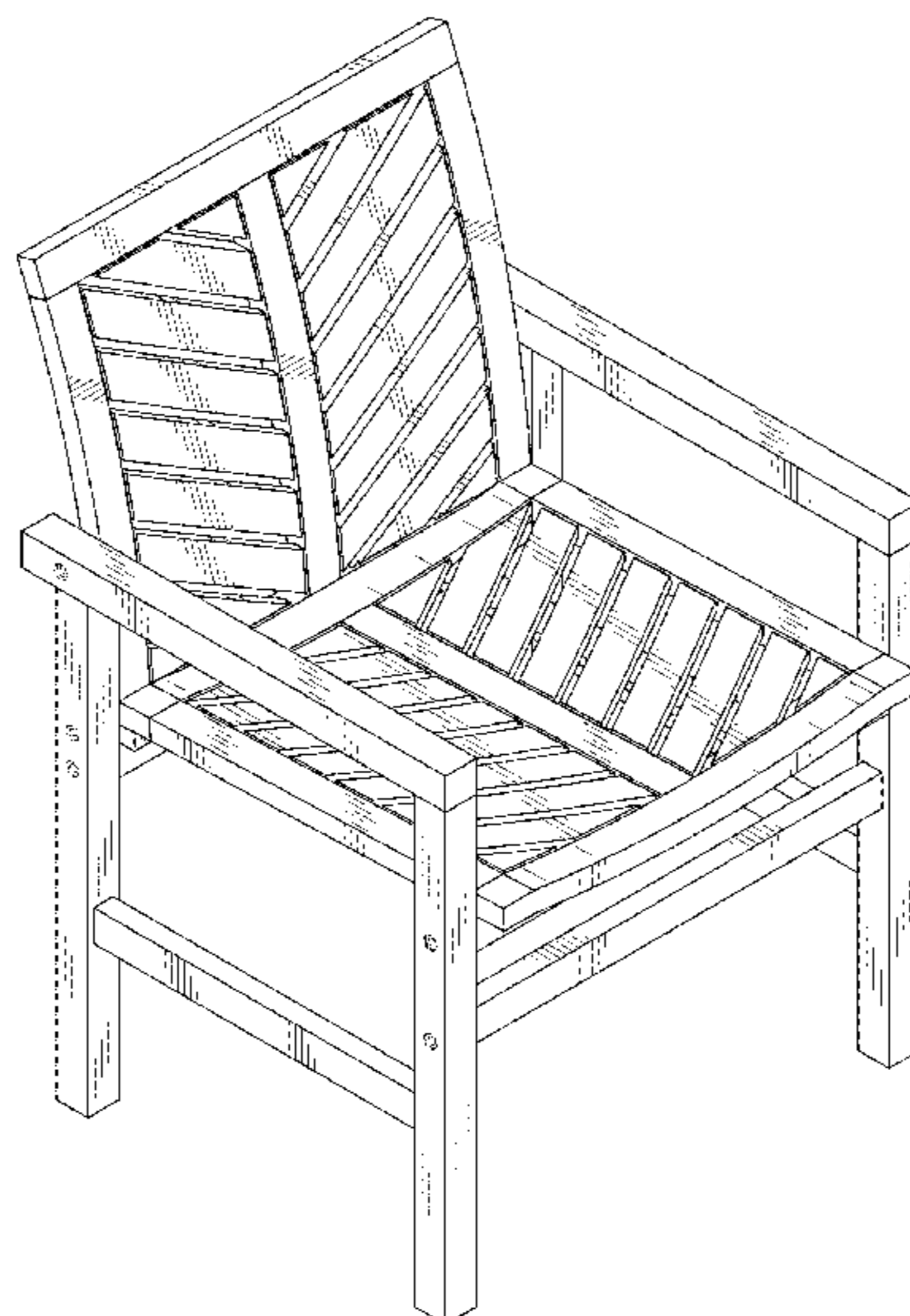

(56)

References Cited

FOREIGN PATENT DOCUMENTS

U.S. PATENT DOCUMENTS

D329,338 S * 9/1992 Komai D6/370
 D331,323 S 12/1992 Grosfillex
 D331,324 S 12/1992 Grosfillex
 D333,042 S * 2/1993 Komai D6/370
 D340,366 S 10/1993 LaMalle
 D350,652 S 9/1994 Wegener
 D417,968 S 12/1999 Van Rhienen
 D418,319 S 1/2000 Van Rhienen
 D419,318 S 1/2000 Hand
 D419,323 S * 1/2000 Muller D6/370
 D419,790 S 2/2000 Rhienen
 D425,718 S * 5/2000 van Valderen D6/370
 D437,699 S 2/2001 Jablonski
 D495,156 S * 8/2004 Gower D6/370
 D498,938 S * 11/2004 Kingsley D6/370
 D513,369 S * 1/2006 Cross D6/370
 D513,900 S 1/2006 Tseng
 D540,056 S * 4/2007 Doughty D6/370
 D544,724 S * 6/2007 Gower D6/374
 D551,459 S * 9/2007 Zagler D6/374
 D617,108 S 6/2010 Niermeyer
 D653,470 S 2/2012 Niermeyer
 D660,039 S * 5/2012 Grotta D6/370
 D668,086 S 10/2012 Lee
 D672,173 S 12/2012 Lee
 8,550,547 B1 * 10/2013 Liu A47C 7/70
 297/121
 D702,071 S 4/2014 Lee
 D703,475 S 4/2014 Lee
 D714,565 S * 10/2014 Davis D6/377
 D720,941 S * 1/2015 Mila Valcarcel D6/370
 D722,803 S 2/2015 Striebel
 D737,067 S * 8/2015 McGlew D6/371
 D739,155 S * 9/2015 Gretz D6/370
 D752,354 S * 3/2016 Fairbanks D6/370
 D761,032 S * 7/2016 Asner D6/370
 D769,014 S * 10/2016 Bougay D6/370
 D779,849 S * 2/2017 White, III D6/370
 D779,850 S * 2/2017 White, III D6/370
 D804,211 S * 12/2017 Gibson D6/370
 D804,212 S * 12/2017 Bernardi D6/370
 D804,213 S * 12/2017 Jonke D6/370
 D805,316 S * 12/2017 Lowsky D6/379
 2012/0067930 A1 3/2012 Talavera Tolentino
 2013/0099540 A1 4/2013 Lucas
 2014/0270932 A1 * 9/2014 Tseng A47C 4/02
 403/345
 2015/0015033 A1 * 1/2015 Traut A47B 83/023
 297/124
 2015/0048656 A1 2/2015 McCullough

CA 161691 12/2015
 CA 166409 1/2016
 CA 171263 10/2016
 CN 201542105 8/2010
 DE 202004017371 1/2005
 DE 102009052760 6/2011
 FR 1166216 11/1958

OTHER PUBLICATIONS

U.S. Appl. No. 29/548,808, filed Dec. 16, 2015, Davis.
 U.S. Appl. No. 29/574,029, filed Aug. 11, 2016, Davis.
 U.S. Appl. No. 29/699,084, filed Jul. 23, 2019, Davis.
 AEON Garvin 2, posted on Amazon.com, posted on Jul. 11, 2005, Apr. 15, 2014 [online], [site visited Oct. 5, 2016] Available from internet <URL:https://www.amazon.com/Garvin-2-Stackable-Chairs-Galvanized-Steel/dp/B00HZSMKVM>.
 Lemoderno Galvanized Steel Side Chair, posted at Amazon.com, posted on May 13, 2014 [online] [site visited Oct. 5, 2016]. Available from internet, <URL:https://www.amazon.com/dp/B00KB3XEWK/ref=psdc_3733821_t3_B01E1N4D9K>.
 TOLIX A chair, posted at Tolix, fr, posted on Mar. 25, 2010, [online], [site visited Oct. 12, 2016]. Available from Internet, <URL:https://web.archive.org/web/20100325202504/http://www.tolix.fr/en/products/1-seats/p/2-a-chair>.
 French Metal Café Chairs from Pottery Barn, posted at Apartment-therapy.com, posted on Mar. 27, 2008, [online], [site visited Oct. 5, 2016]. Available from Internet, <URL:http://www.apartmenttherapy.com/french-café-chairs-from-potter-46567>.
 Airelle Side Chair; posted at Wayfair.com, posted on Nov. 7, 2015 [online], [site visited Mar. 30, 2017]. Available from Internet, <https://www.wayfair.com/Airelle-Side-Chair-LRFY1161.html>.
 “Unfinished Wood Mission Dining Chair (Set of 2)” Jan. 13, 2015, homedepot.com, site visited Aug. 23, 2017. http://www.homedepot.com/p/International-Concepts-Unfinished-Wood-Mission-Dining-Chair-Set-of-2-265P/204684182.
 “Mission Shaker Oak Sidechairs—Pair” Jul. 19, 2013, horizon-custom-homes.com, site visited Aug. 23, 2017. http://www.horizon-custom-homes.com/Mission_Furniture_Dining.html.
 Image seen on Pinterest.DIY Project; pinterest.com; [seen approximately Feb. 1, 2018].
 U.S. Appl. No. 29/548,808, filed Oct. 27, 2016.
 U.S. Appl. No. 29/548,808, filed May 5, 2017.
 U.S. Appl. No. 29/574,029, filed Sep. 1, 2017.
 U.S. Appl. No. 29/699,084, dated Sep. 17, 2020, Notice of Allowance.

* cited by examiner

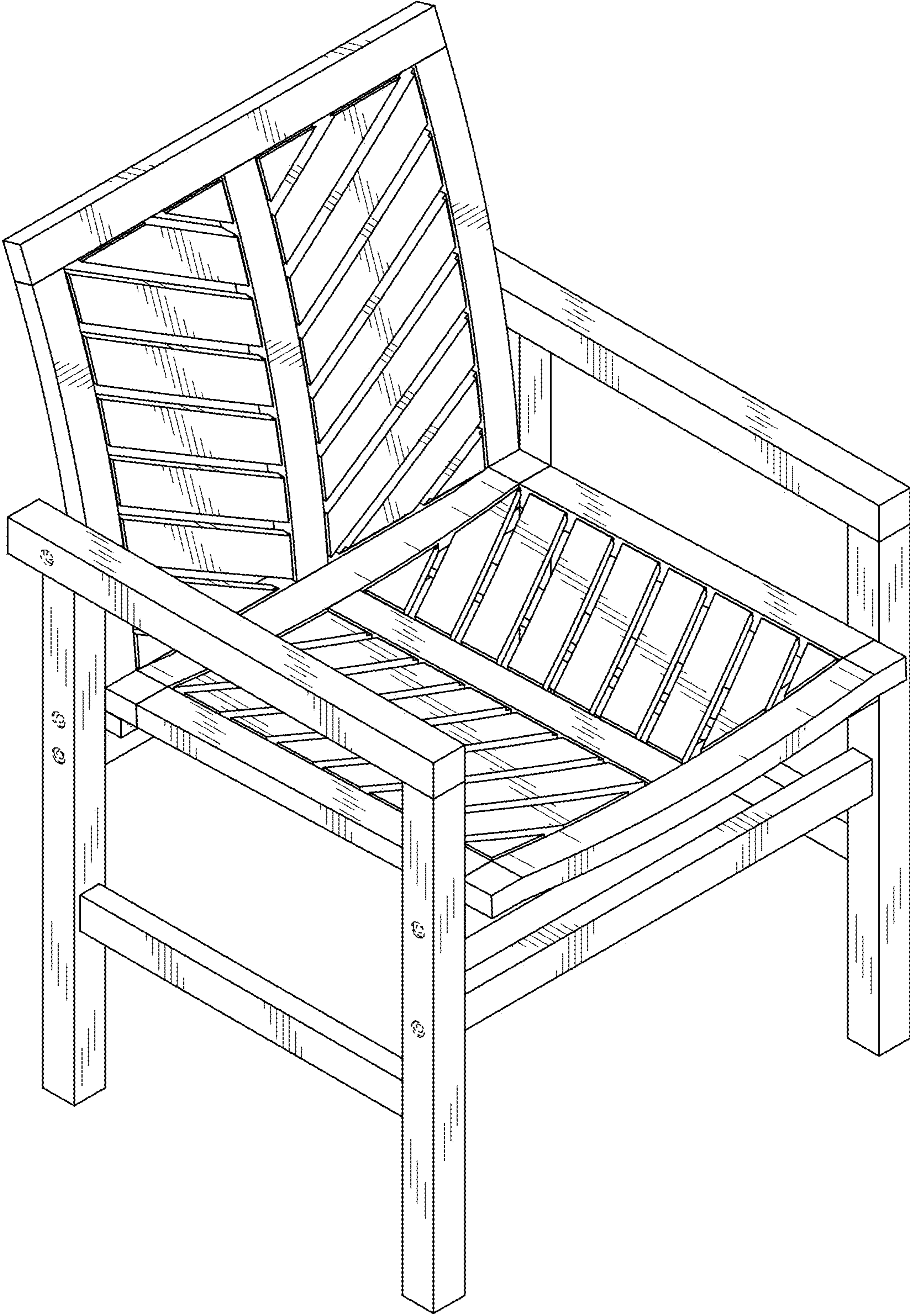

FIG. 1

FIG. 2

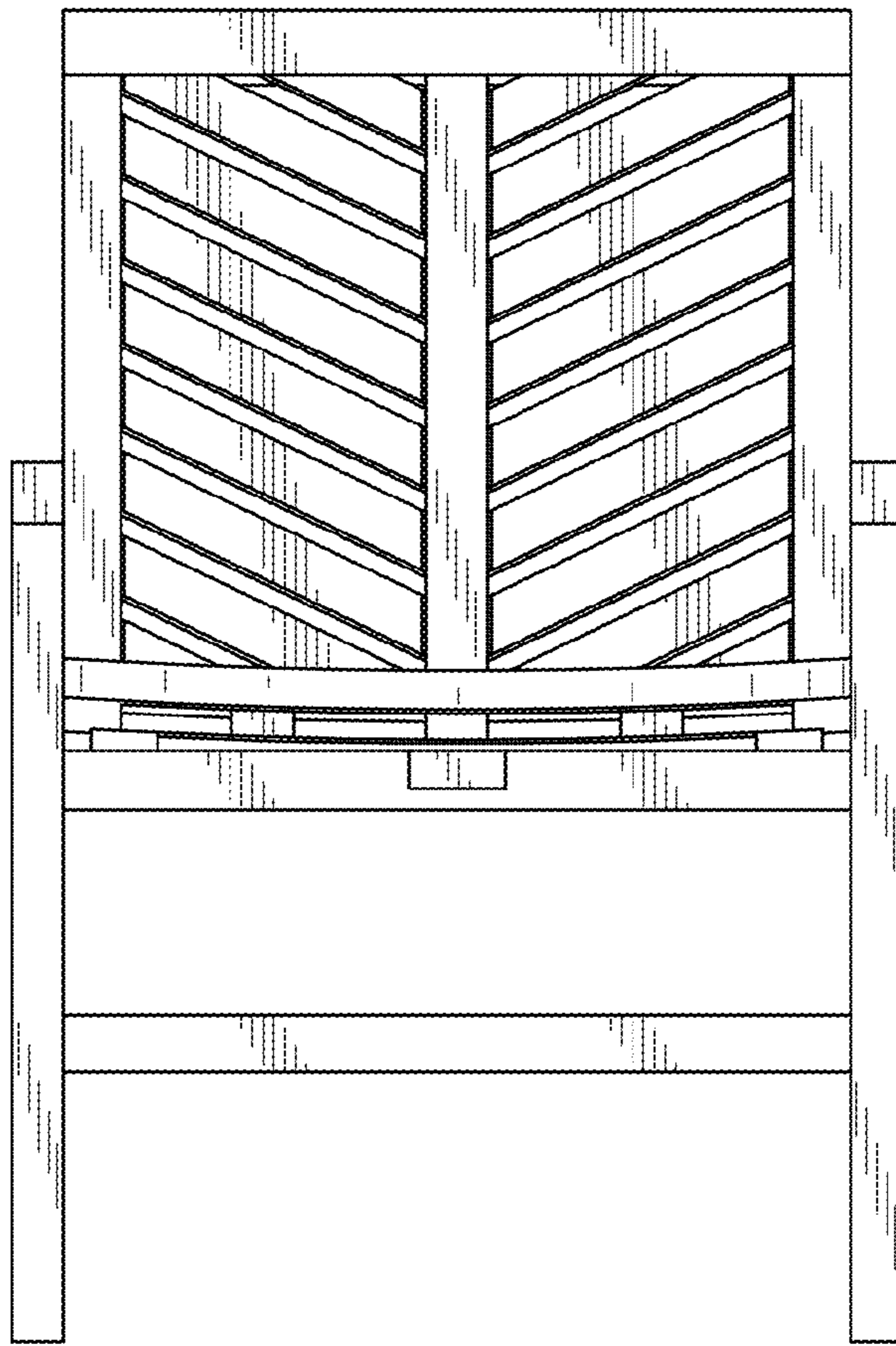
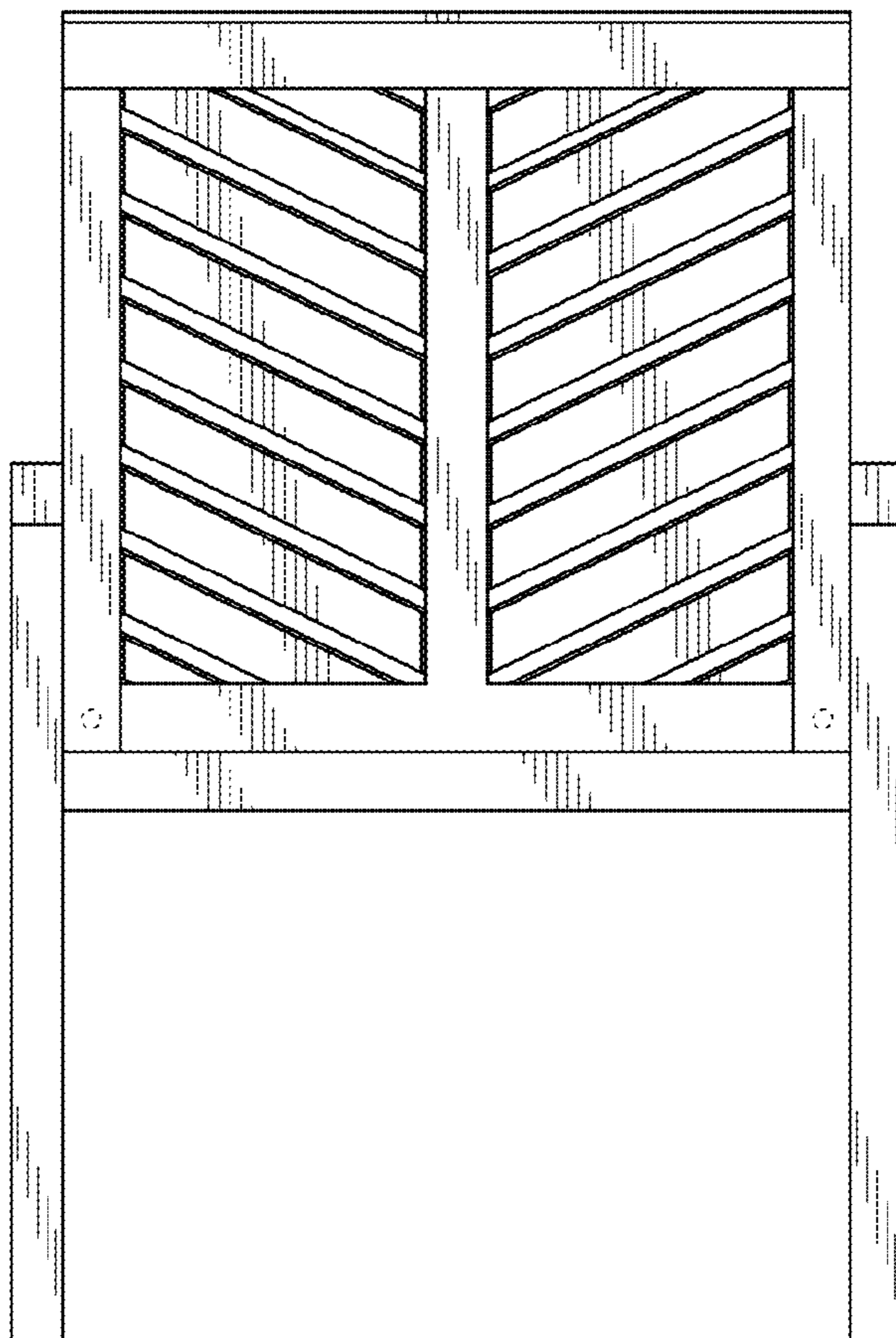

FIG. 3



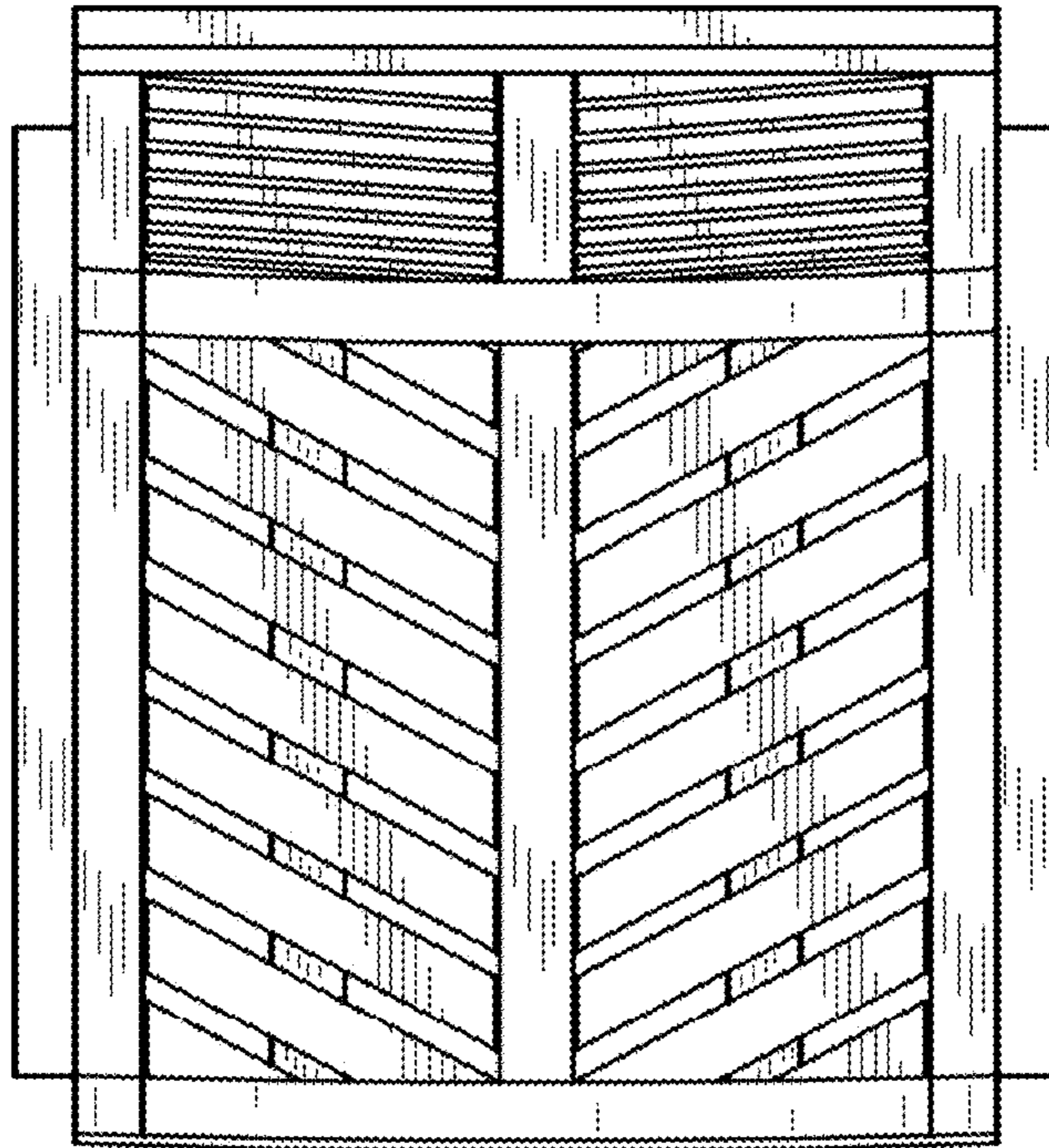

FIG. 4

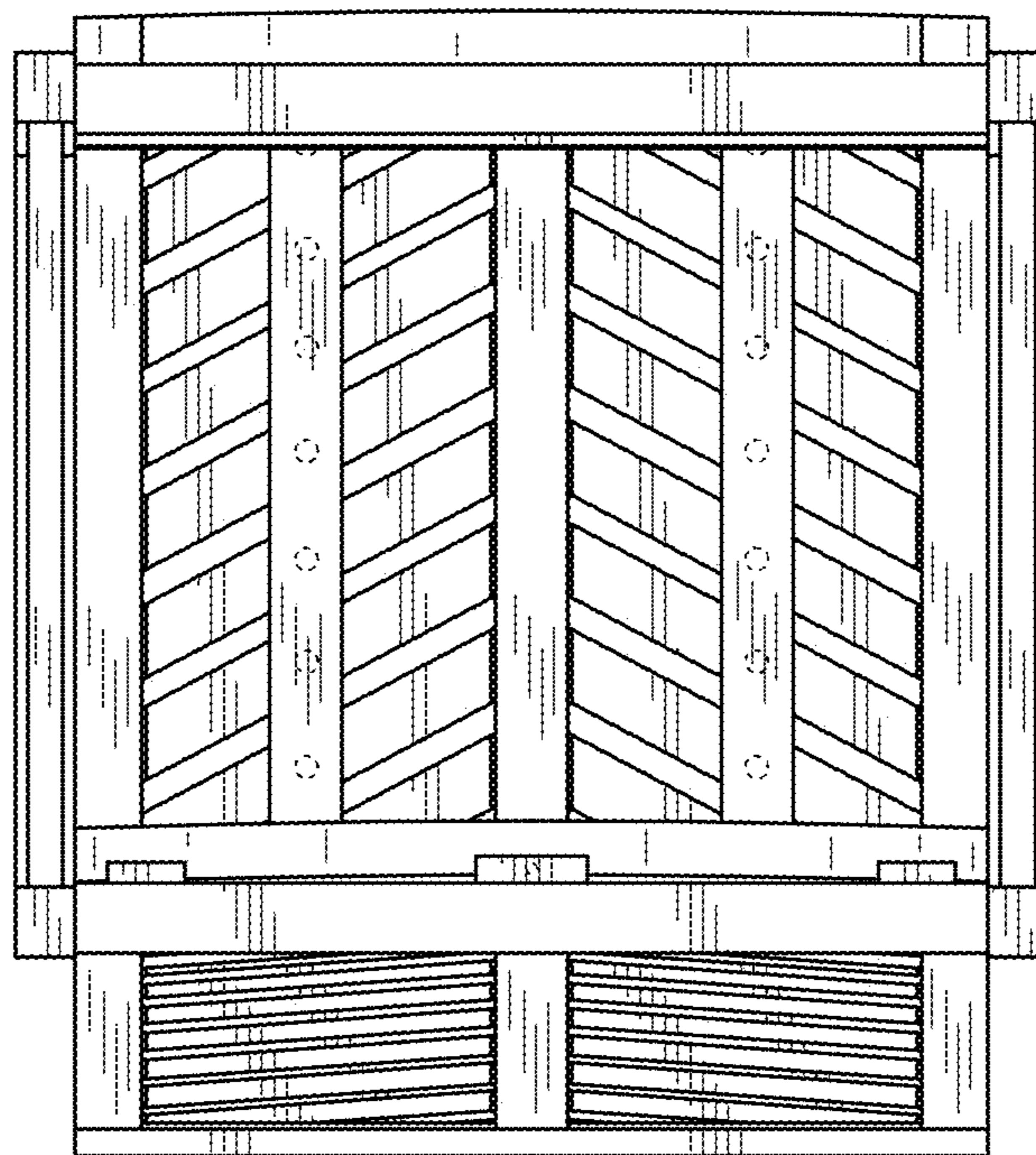

FIG. 5

FIG. 6

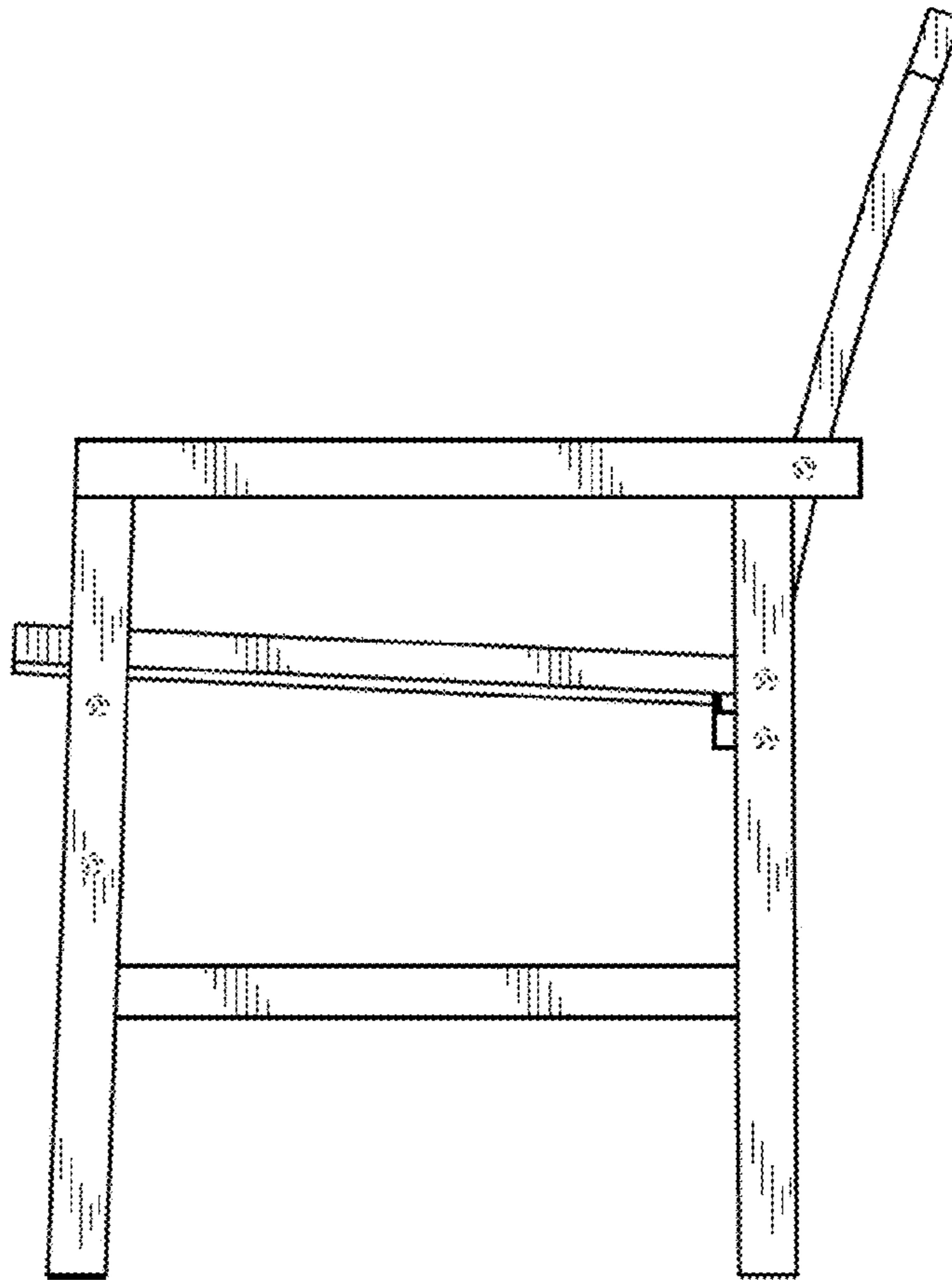

FIG. 7

