



US00D901178S

(12) **United States Design Patent**
Kim et al.

(10) **Patent No.:** **US D901,178 S**

(45) **Date of Patent:** **** Nov. 10, 2020**

(54) **ELECTRONICS CASE**

(71) Applicant: **Harman International Industries, Incorporated**, Northridge, CA (US)

(72) Inventors: **Hyo Jin Kim**, Shenzhen (CN);
Effrosini A. Karayiannis, St. Louis, MO (US); **Derek Campbell**, Baltimore, MD (US)

(73) Assignee: **Harman International Industries, Incorporated**, Northridge, CA (US)

(**) Term: **15 Years**

(21) Appl. No.: **29/674,907**

(22) Filed: **Dec. 27, 2018**

(51) **LOC (12) Cl.** **03-01**

(52) **U.S. Cl.**
USPC **D3/298**

(58) **Field of Classification Search**
USPC D3/201, 203.1, 203.2, 273, 274, 284,
D3/285, 291, 289, 302, 276, 294, 295,
D3/298, 318, 901, 902, 903, 270, 300;
D27/189, 190, 191; D28/82, 7; D13/108
CPC ... A45C 5/00; A45C 2011/001; A45C 13/002;
A45C 5/08; A45C 11/00; H04R 1/1025;
H04R 1/1033

See application file for complete search history.

(56) **References Cited**

U.S. PATENT DOCUMENTS

D584,700 S	1/2009	Urry et al.	
D710,824 S	8/2014	Mackiewicz et al.	
D766,214 S	9/2016	Mackiewicz et al.	
D791,479 S *	7/2017	Son	D3/298
D816,322 S *	5/2018	Choe	D3/201
D816,994 S	5/2018	Fischer et al.	
D822,374 S *	7/2018	Hung	D3/201
D838,480 S *	1/2019	Son	D3/294

(Continued)

OTHER PUBLICATIONS

Amazon, "Wireless Earbuds, AUGYMER Bluetooth 5.0 True Earphones . . . ", First on sale Aug. 20, 2019. (<https://www.amazon.com/dp/B07W5P3NDG/>) (Year: 2019).*

(Continued)

Primary Examiner — April Rivas

(74) *Attorney, Agent, or Firm* — Plumsea Law Group, LLC

(57) **CLAIM**

The ornamental design for an electronics case, as shown and described.

DESCRIPTION

FIG. 1 is a perspective view of an electronics case showing the new design;

FIG. 2 is a front elevational view thereof;

FIG. 3 is a rear elevational view thereof;

FIG. 4 is a side elevational view thereof;

FIG. 5 is an opposite side elevational view thereof;

FIG. 6 is a top view thereof;

FIG. 7 is a bottom view thereof;

FIG. 8 is a perspective view thereof, shown in an open configuration;

FIG. 9 is a front elevational view thereof, shown in an open configuration;

FIG. 10 is a rear elevational view thereof, shown in an open configuration;

FIG. 11 is a side elevational view thereof, shown in an open configuration;

FIG. 12 is an opposite side elevational view thereof, shown in an open configuration;

FIG. 13 is a top view thereof, shown in an open configuration; and,

FIG. 14 is a bottom view thereof, shown in an open configuration.

The broken lines in the figures illustrate portions of the design that form no part of the claimed design.

1 Claim, 14 Drawing Sheets

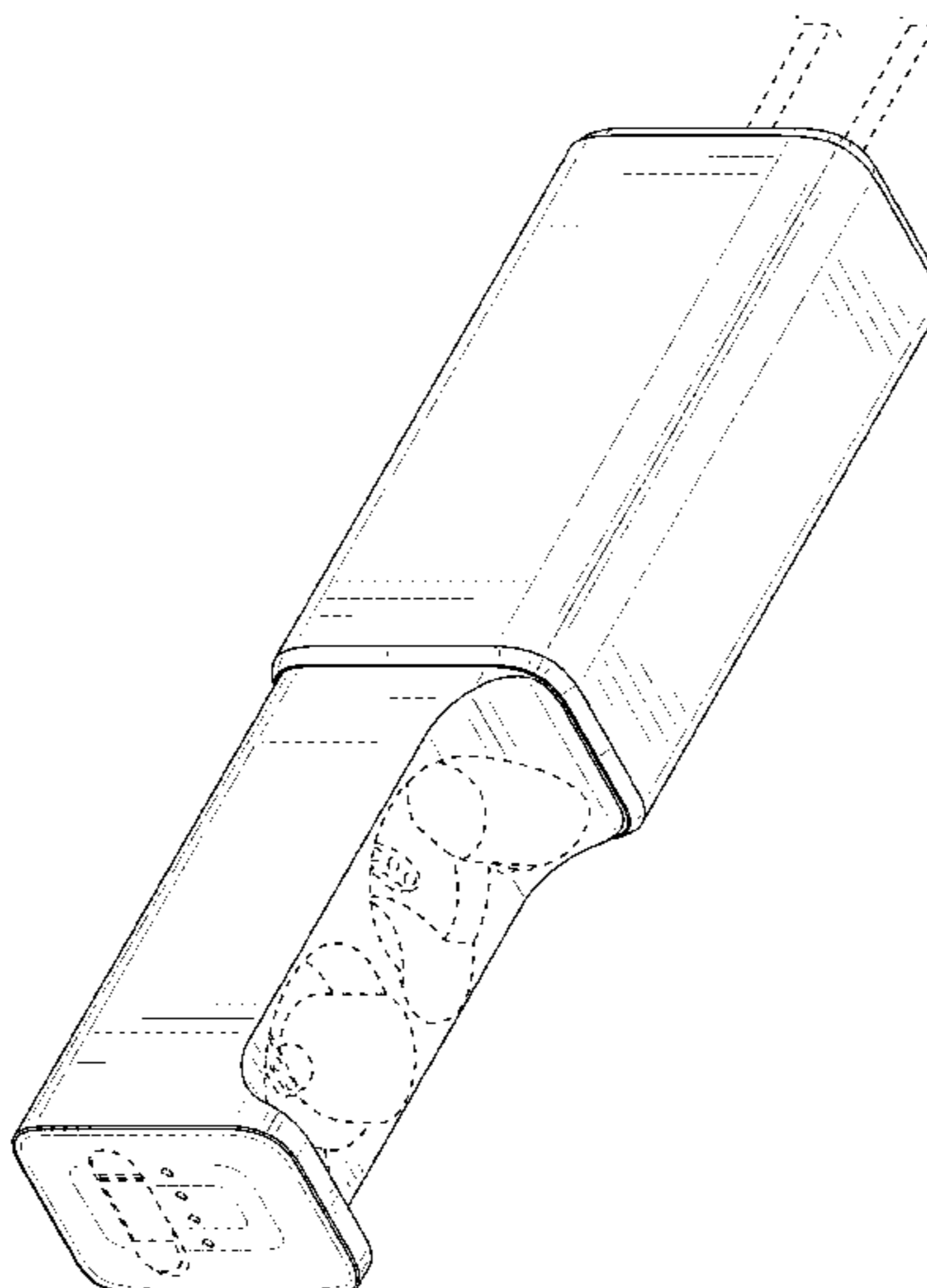

(56)

References Cited

U.S. PATENT DOCUMENTS

D839,920 S 2/2019 Demin et al.
D843,721 S * 3/2019 Yuan D3/274
D843,938 S * 3/2019 Park D13/108
D846,264 S * 4/2019 Wu D3/201
D848,149 S * 5/2019 Chen D3/302
D851,913 S * 6/2019 Yu D3/201
D864,110 S * 10/2019 Yoshimura D13/108
D870,451 S * 12/2019 Birger D3/201
2018/0014436 A1* 1/2018 Milevski H05K 9/0007
2019/0283921 A1* 9/2019 Stamoulis B26B 21/40

OTHER PUBLICATIONS

CNET, "UA True Wireless Flash review . . .", Posted Mar. 5, 2019.
(<https://www.cnet.com/reviews/ua-true-wireless-flash-engineered-by-jbl-review/>) (Year: 2019).*

Amazon, "EngraSun Bluetooth 5.0 Mini True Wireless Stereo HiFi Earbuds with Charging Case . . .", First on sale Aug. 23, 2019.
(<https://www.amazon.com/dp/B07WPCQX62>) (Year: 2019).*

Design U.S. Appl. No. 29/641,044, filed Mar. 19, 2018.

Design U.S. Appl. No. 29/688,606, filed Apr. 23, 2019.

Design U.S. Appl. No. 29/695,337, filed Jun. 18, 2019.

* cited by examiner

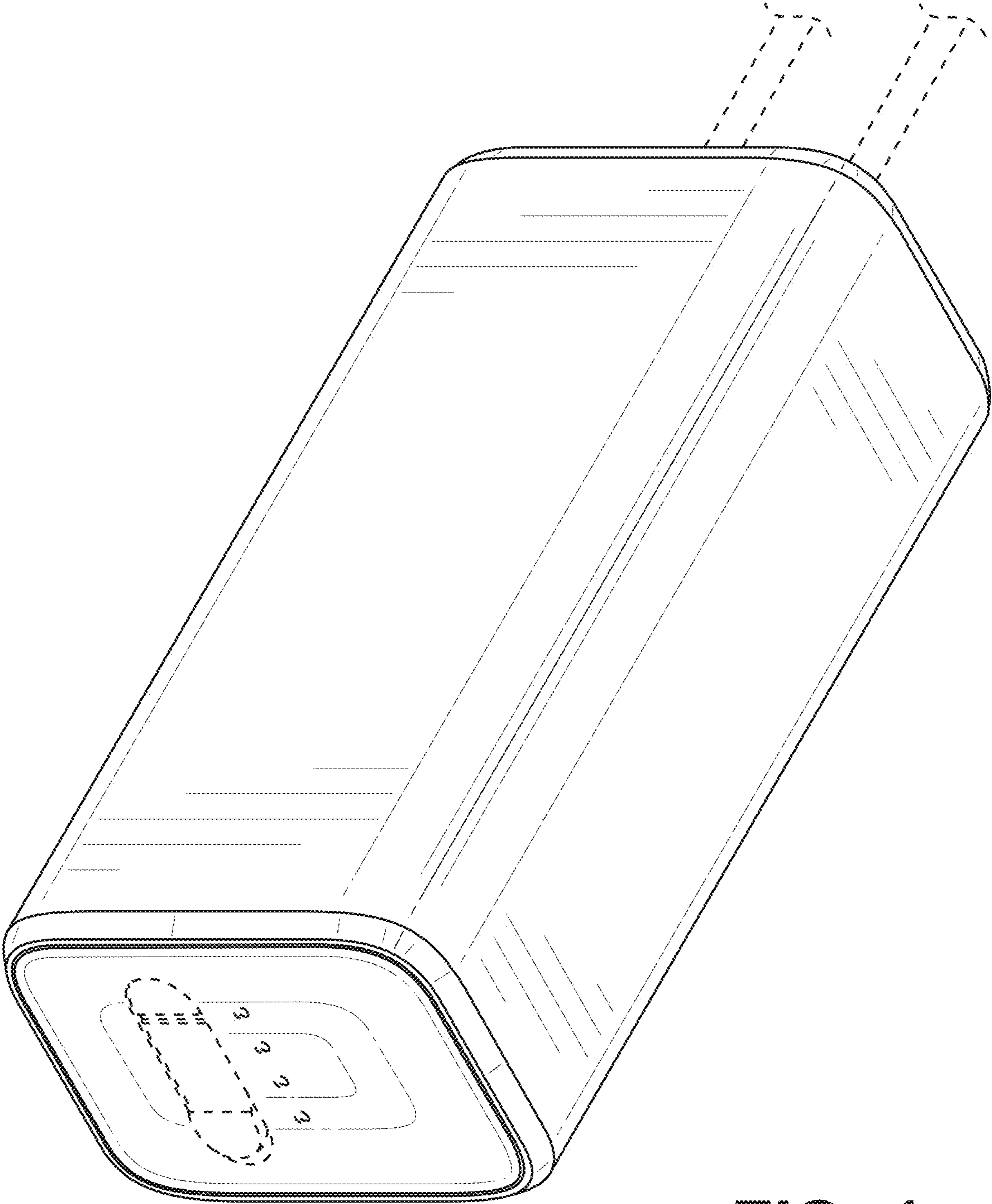

FIG. 1

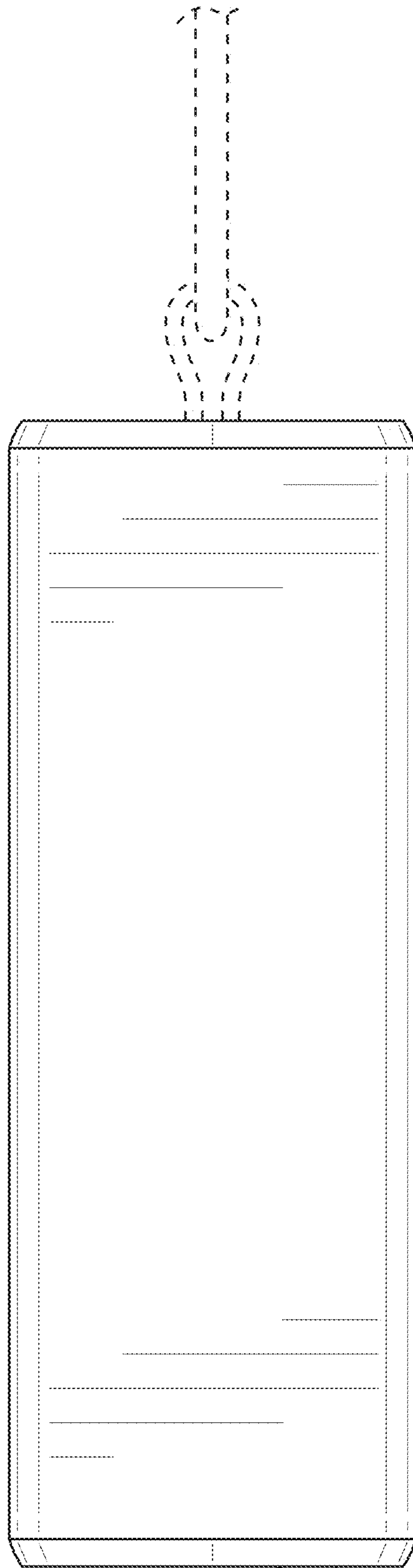

FIG. 2

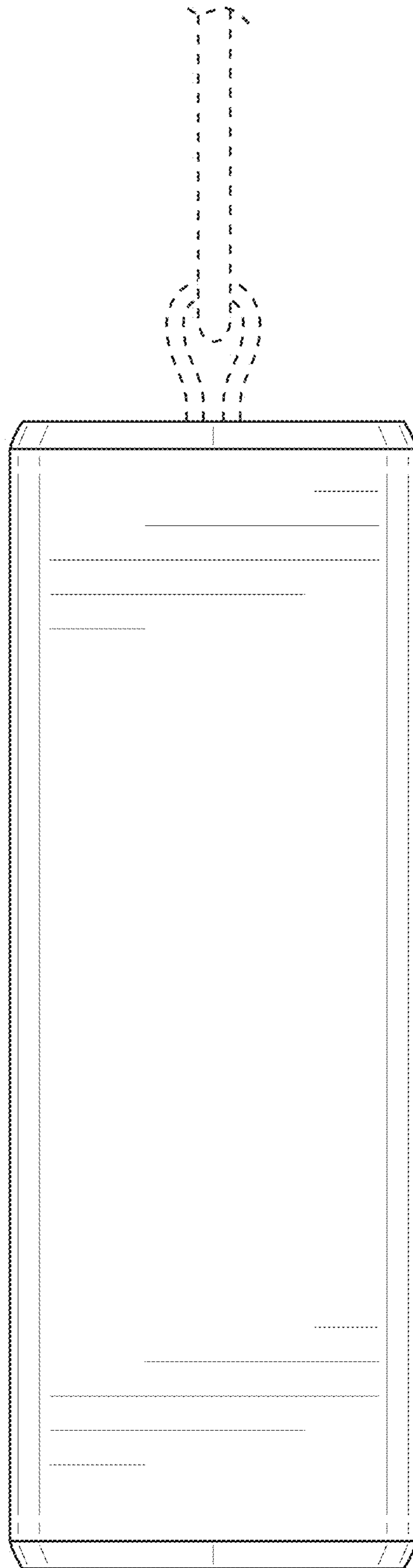

FIG. 3

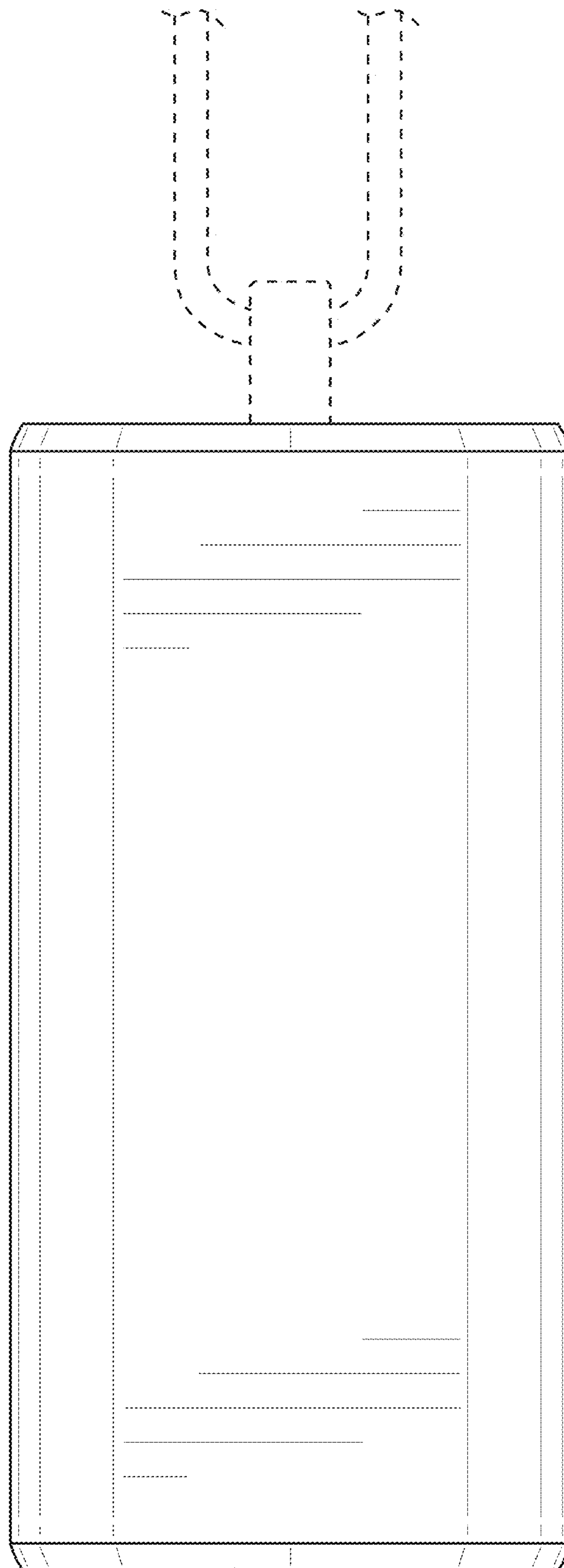

FIG. 4

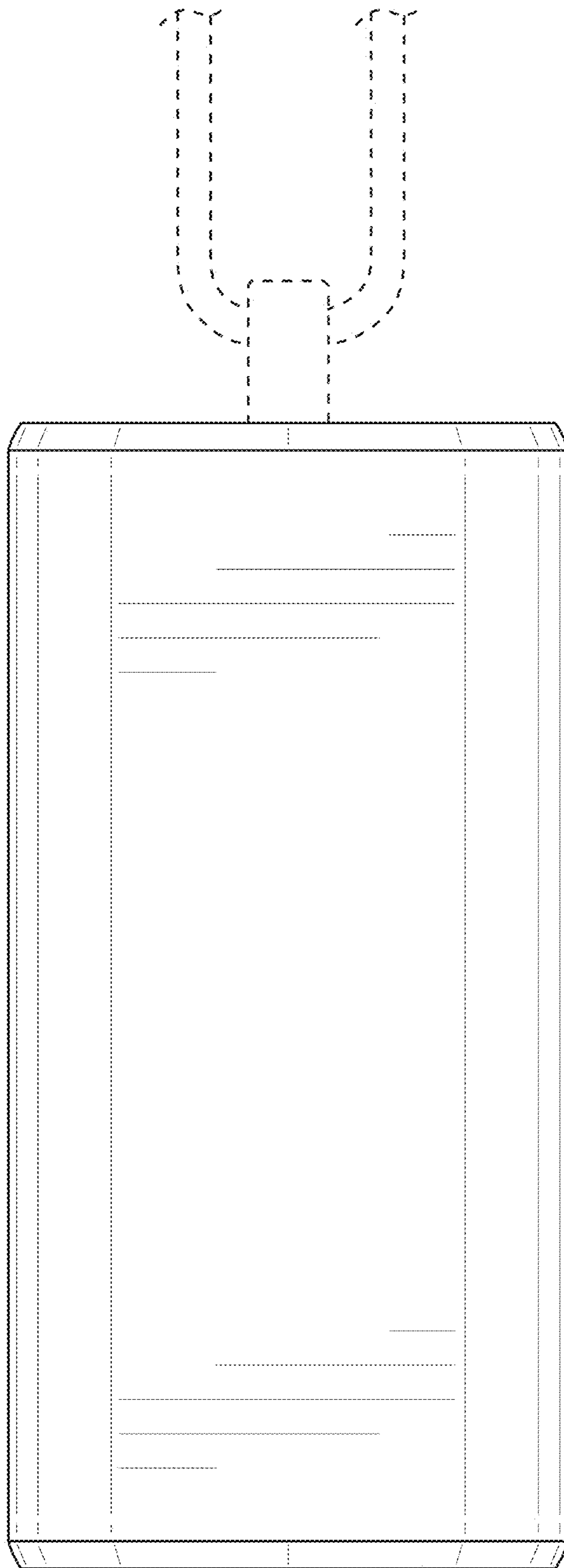

FIG. 5

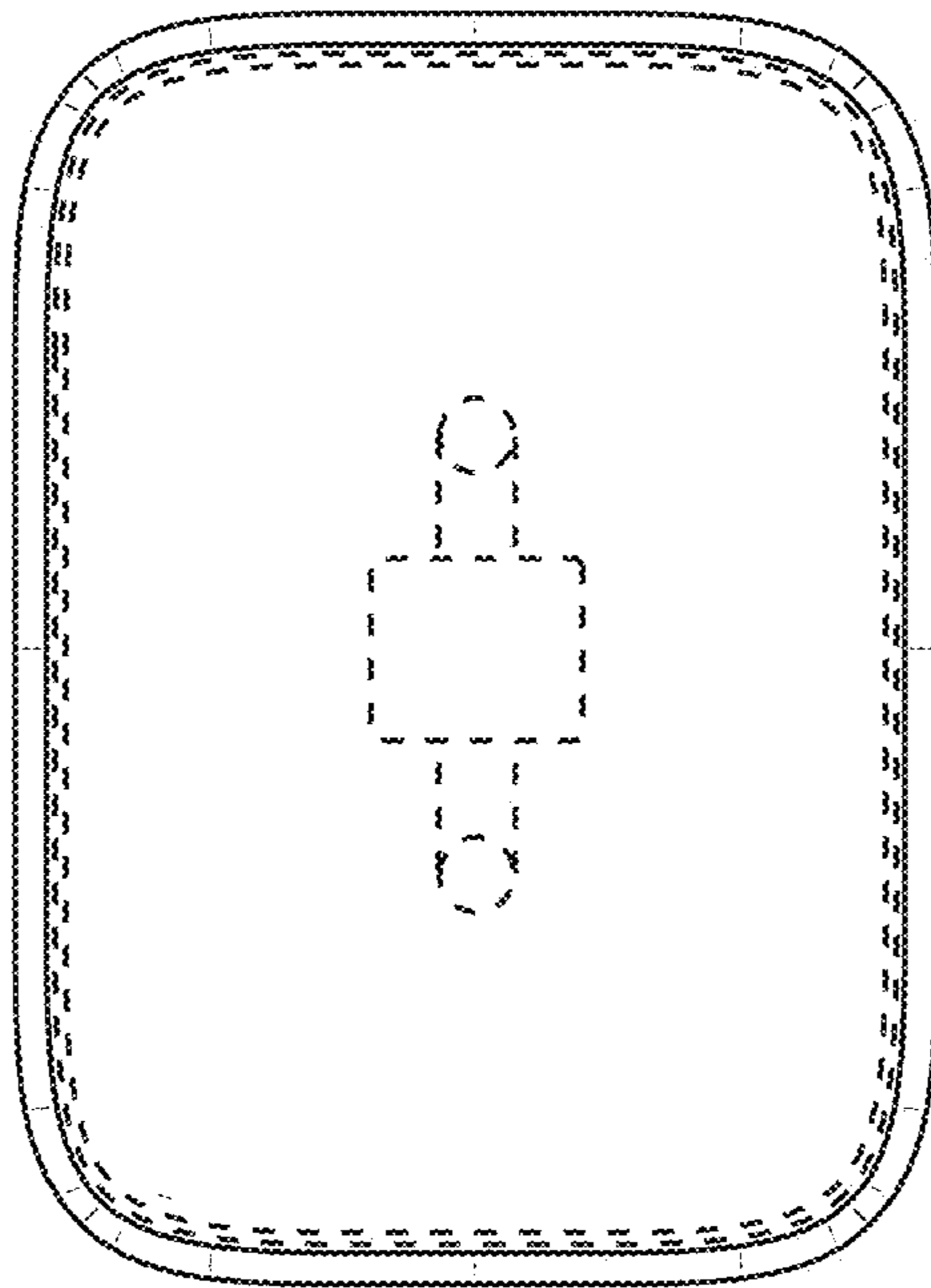

FIG. 6

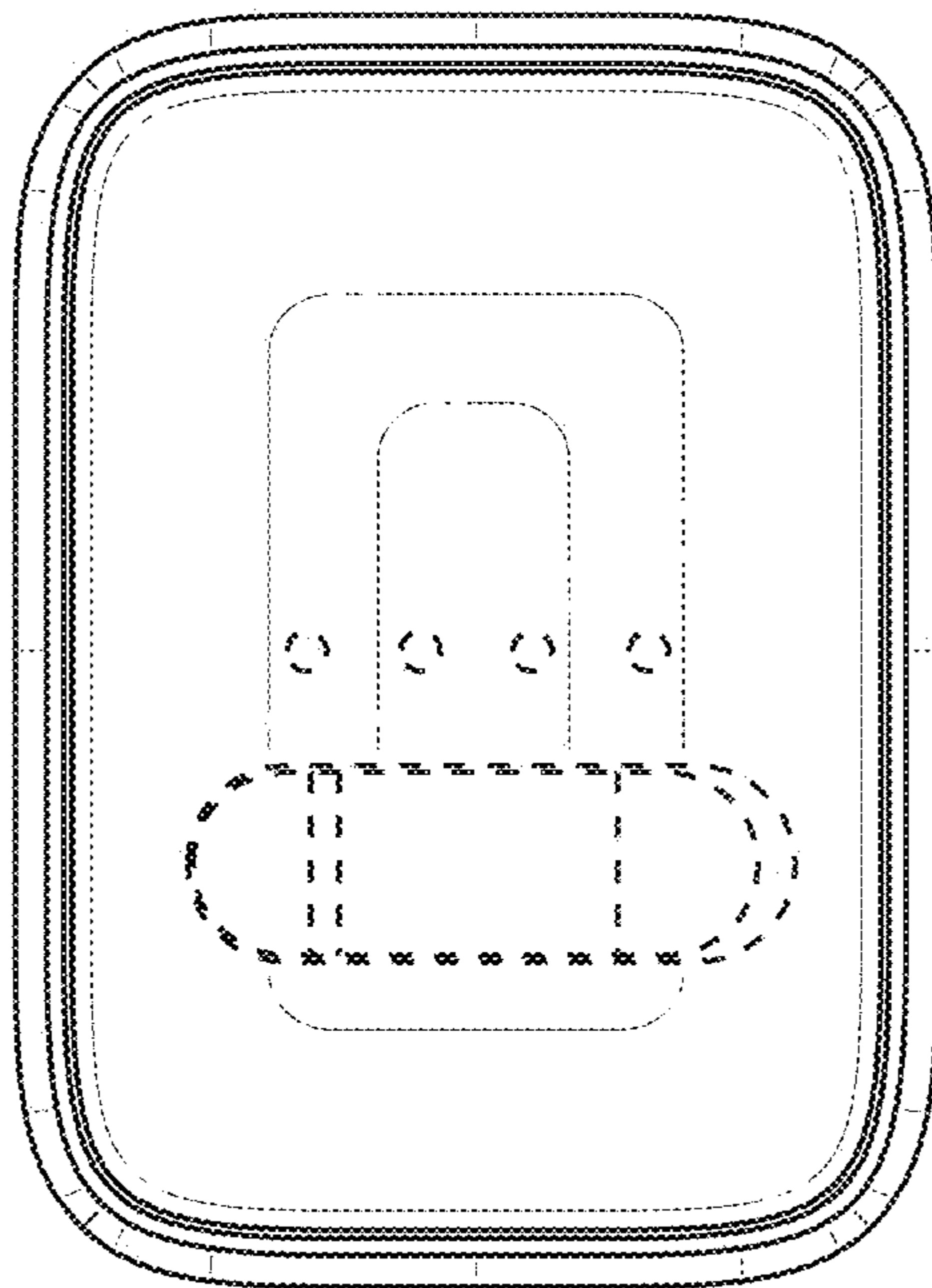

FIG. 7

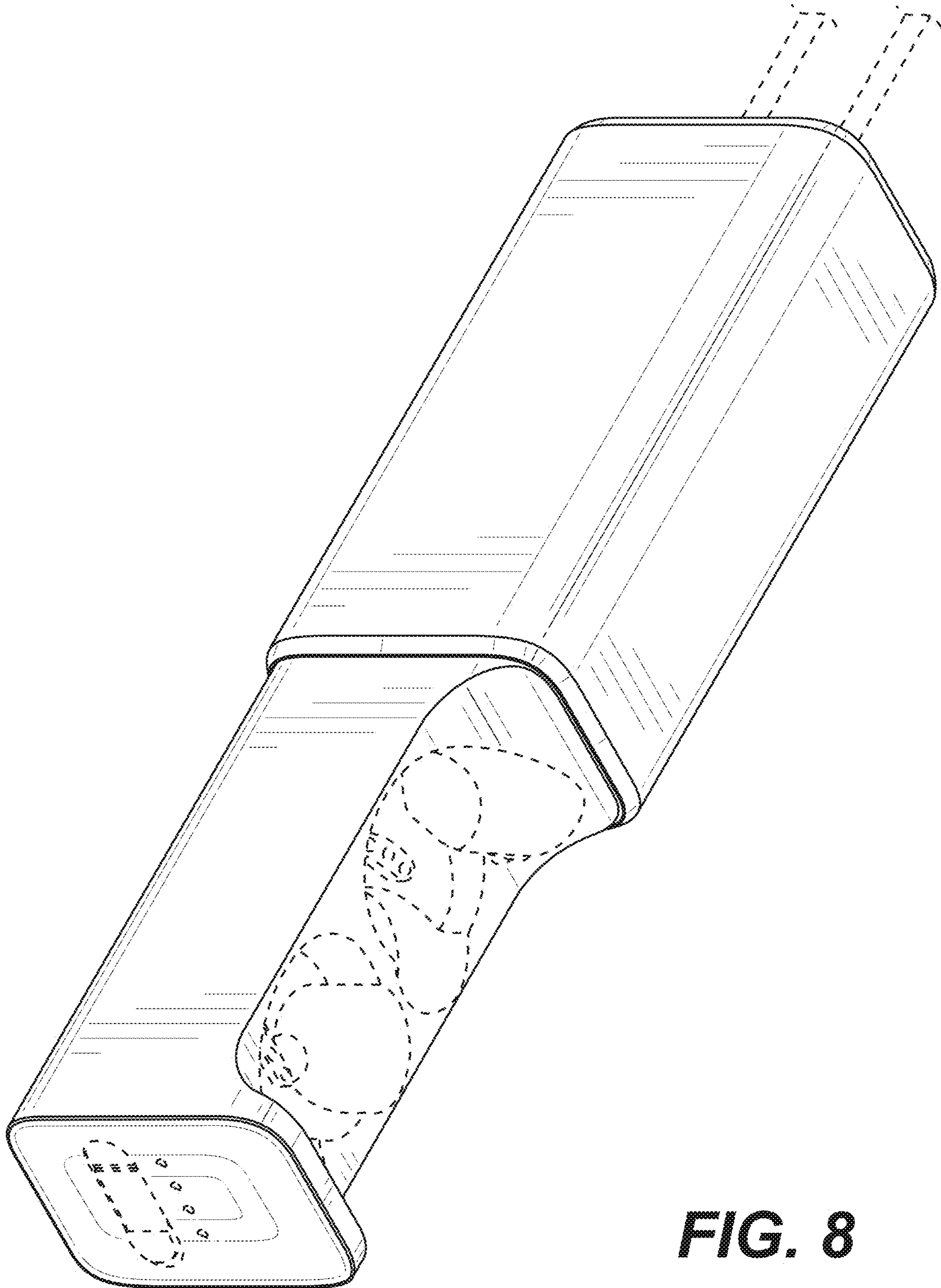

FIG. 8

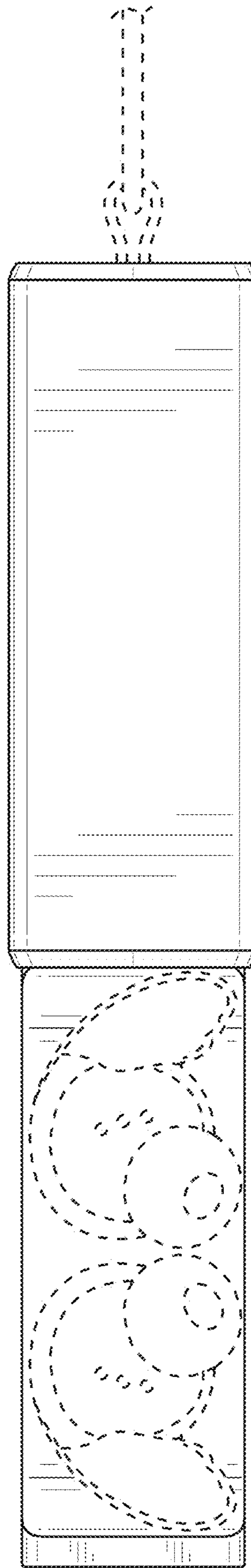

FIG. 9

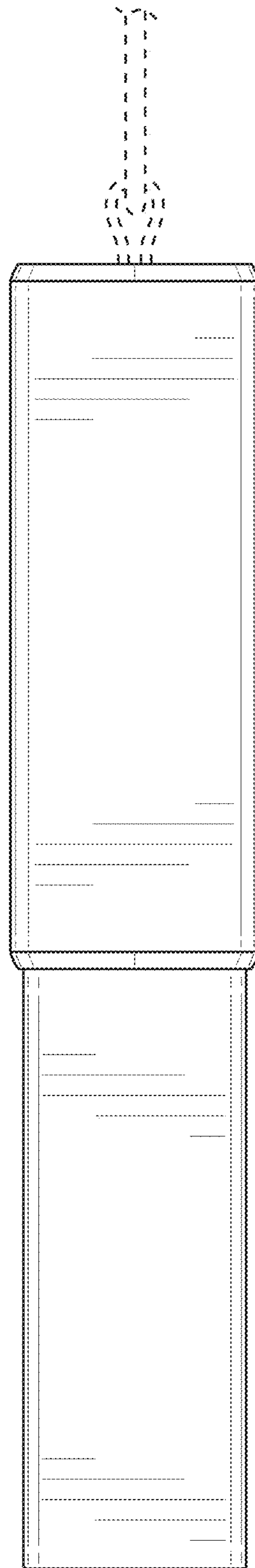

FIG. 10

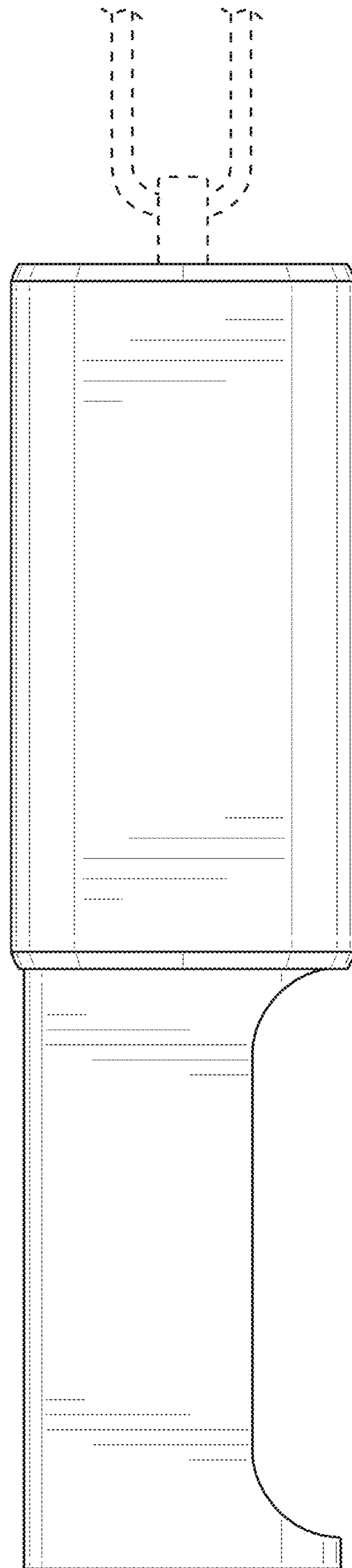

FIG. 11

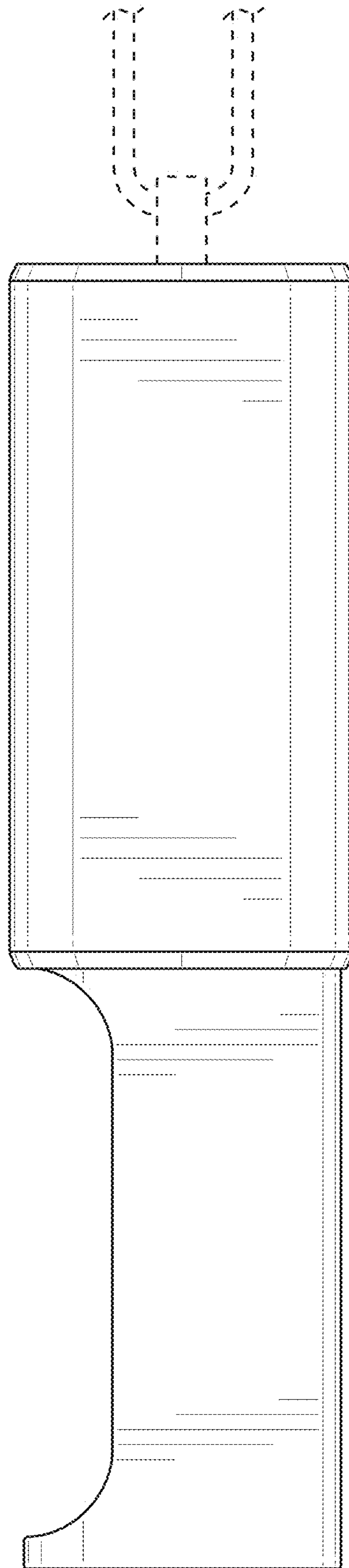

FIG. 12

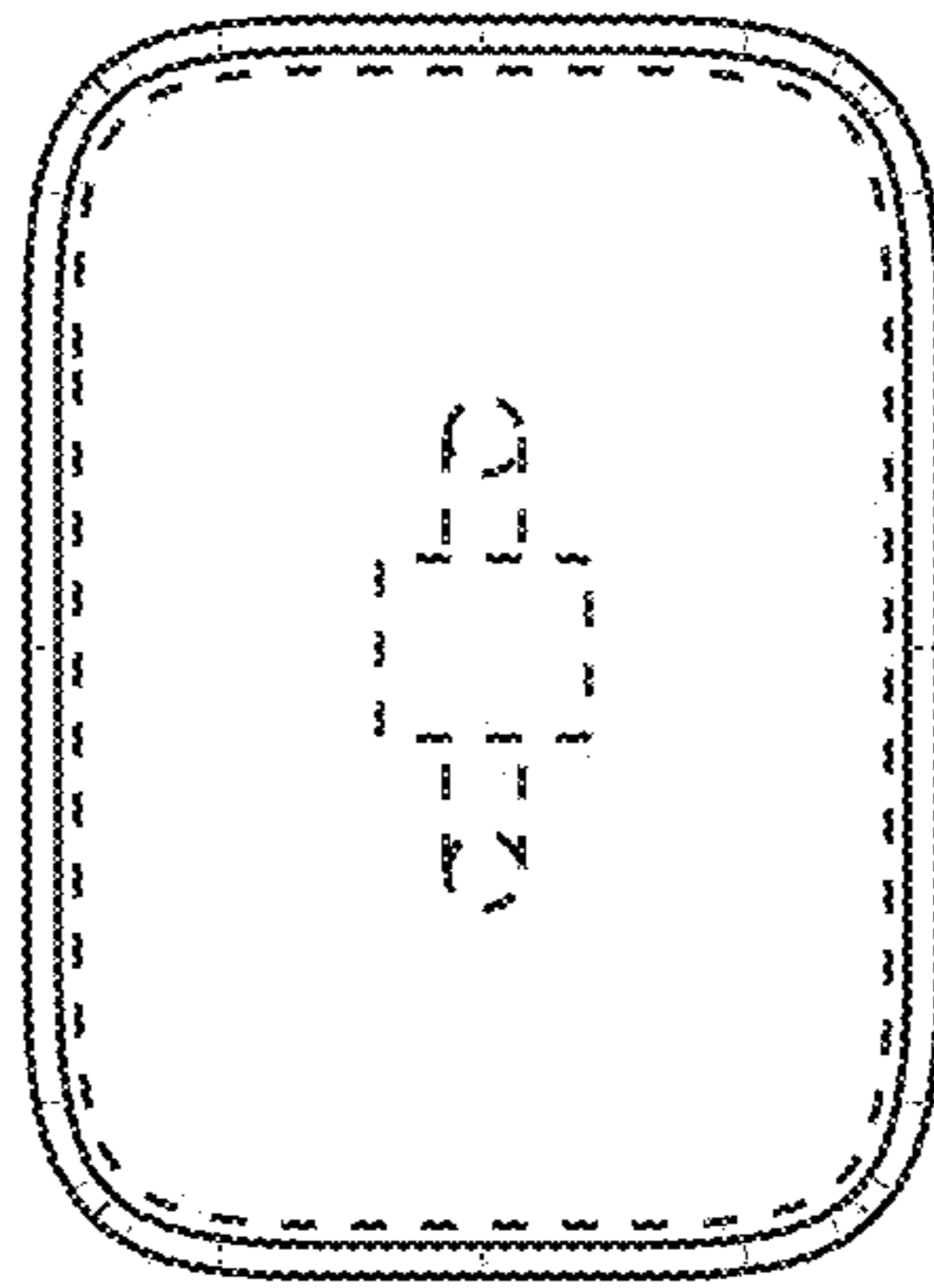

FIG. 13

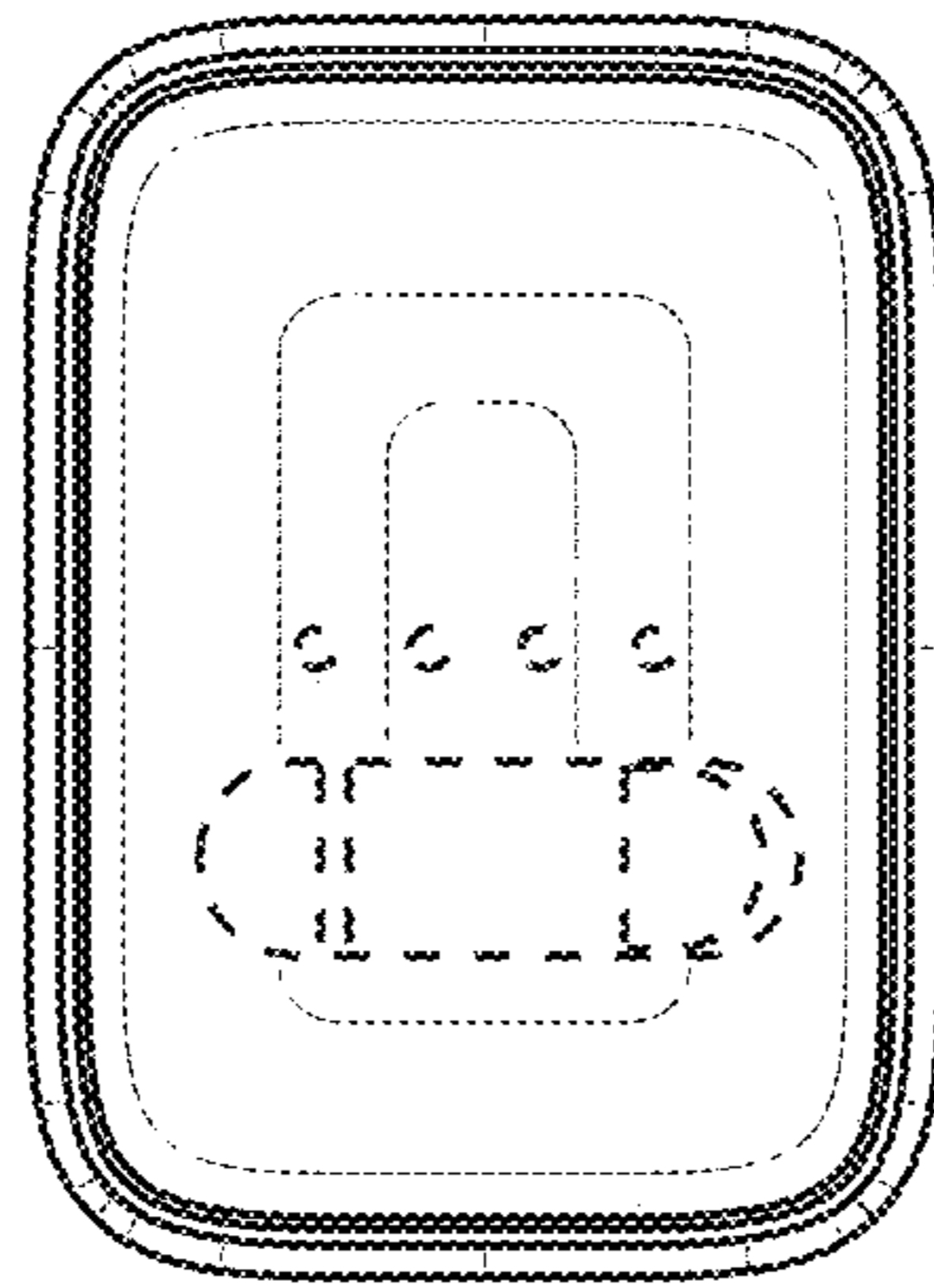

FIG. 14