



US00D901168S

(12) **United States Design Patent**
Axelrod

(10) **Patent No.:** **US D901,168 S**

(45) **Date of Patent:** **** Nov. 10, 2020**

(54) **MEDICAL ALERT KEYCHAIN PENDANT WITH A USB AND ENGRAVED PLATE POCKET**

(71) Applicant: **Jeffrey S. Axelrod**, Stone Lake, WI (US)

(72) Inventor: **Jeffrey S. Axelrod**, Stone Lake, WI (US)

(**) Term: **15 Years**

(21) Appl. No.: **29/713,124**

(22) Filed: **Nov. 13, 2019**

(51) **LOC (12) Cl.** **03-01**

(52) **U.S. Cl.**
USPC **D3/207**; D3/203.1; D14/480.3

(58) **Field of Classification Search**
USPC D3/1, 203.1, 203.6, 207-212; D11/1-2, D11/14, 26-29, 89-92, 44, 48, 79, 81, 95, D11/99, 157, 164, 480.3, 480.2, 484.1; D20/23; D14/480.5, 480.3; D8/38; 63/26-28, 32; 70/456 B; 206/37.1
See application file for complete search history.

(56) **References Cited**

U.S. PATENT DOCUMENTS

D339,426 S *	9/1993	Spencer, Jr.	D28/66
D441,504 S *	5/2001	Stvartak	D28/66
D493,576 S *	7/2004	Ward	D28/66
D517,799 S *	3/2006	Oas	D3/203.2
D523,235 S *	6/2006	Oas	D3/207
D543,018 S *	5/2007	Bates	D3/207
D543,351 S *	5/2007	Bates	D3/207
D544,150 S *	6/2007	Aledo	D28/66
D546,056 S *	7/2007	Oas	D3/203.2
D548,887 S *	8/2007	Aledo	D28/66
D557,134 S *	12/2007	Wolpert	D9/453
D559,530 S *	1/2008	Bates	D3/207
D605,059 S *	12/2009	Cooper	D9/730
D623,399 S *	9/2010	McSweyn	D3/208

(Continued)

OTHER PUBLICATIONS

Responder Medical Alert ID USB Keychain, Amazon.com, Date First Available: Jan. 24, 2020, [online], [site visited Sep. 14, 2020]. <URL: <https://www.amazon.com/Responder-Medical-Alert-USB-Keychain/dp/B0846GVTTN>> (Year: 2020).*

(Continued)

Primary Examiner — T Chase Nelson

Assistant Examiner — Jonathan J. Han

(74) *Attorney, Agent, or Firm* — QuickPatents, LLC; Kevin Prince

(57) **CLAIM**

The ornamental design for a medical alert keychain pendant with a USB and engraved plate pocket, as shown and described.

DESCRIPTION

FIG. 1 is a front perspective view of a medical alert keychain pendant with a USB and engraved place pocket, showing my new design in an open configuration; FIG. 2 is a rear perspective view of FIG. 1; FIG. 3 is a front perspective view thereof, illustrated in a closed configuration; FIG. 4 is a rear perspective view of FIG. 3; FIG. 5 is a front elevational view of FIG. 3; FIG. 6 is a rear elevational view of FIG. 3; FIG. 7 is a right-side elevational view of FIG. 3, the left-side elevational view being a mirror image thereof; FIG. 8 is a top plan view of FIG. 3; and, FIG. 9 is a bottom plan view of FIG. 3. The broken lines showing a raised logo and text in the figures depict environmental matter and form no part of the claimed design.

1 Claim, 8 Drawing Sheets

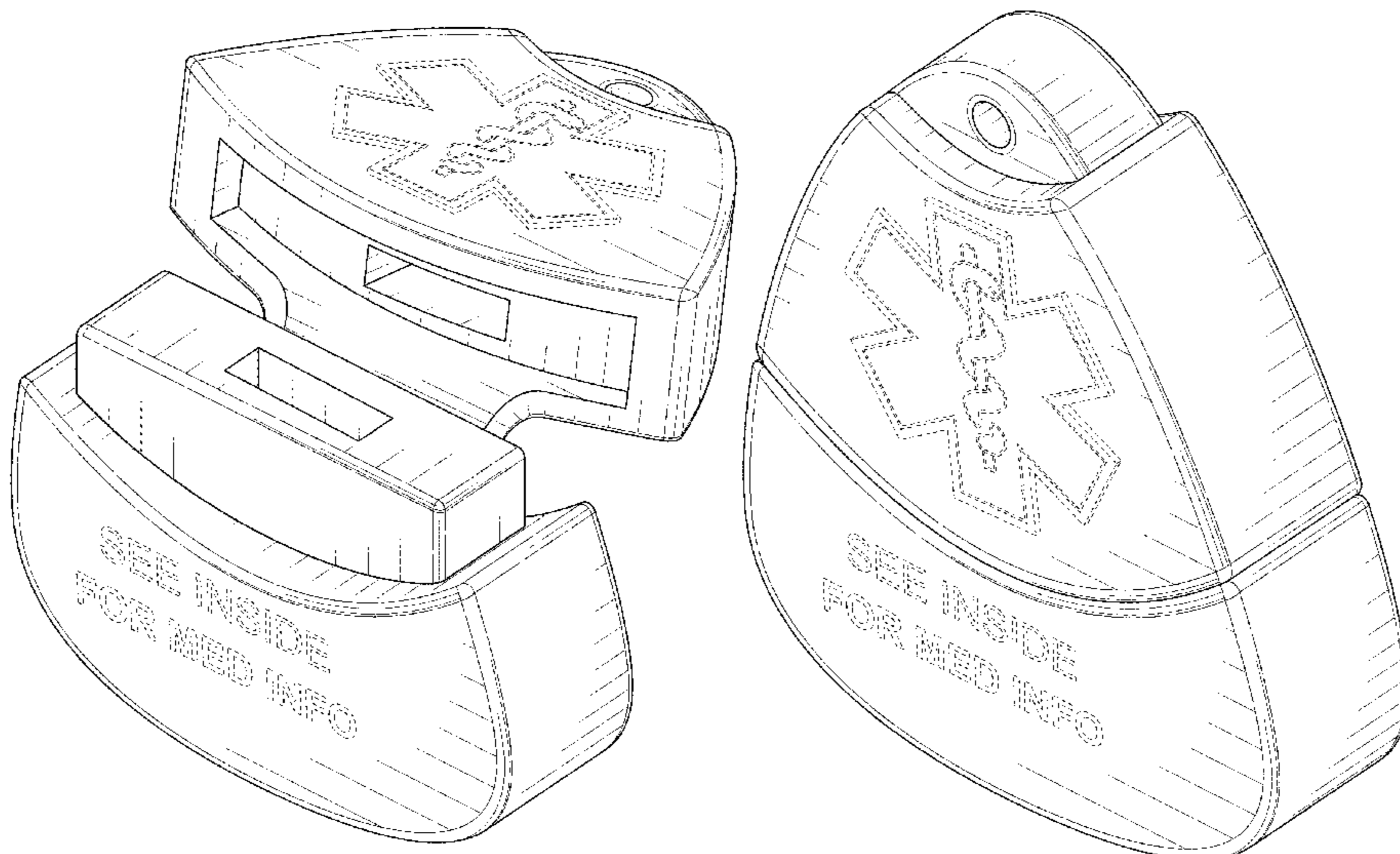

(56)

References Cited

U.S. PATENT DOCUMENTS

D623,848 S * 9/2010 Hirvimaki D3/207
 D624,532 S * 9/2010 Huskinson D14/250
 D624,551 S * 9/2010 Cohen D14/480.5
 D624,553 S * 9/2010 Mamone D14/480.5
 D624,747 S * 10/2010 McSweyn D3/208
 D627,675 S * 11/2010 Graham D11/79
 D631,053 S * 1/2011 Bailey D14/480.1
 D631,884 S * 2/2011 Klein D14/435.1
 D633,096 S * 2/2011 Corcoran D14/480.1
 D635,142 S * 3/2011 Borislow D14/435.1
 D636,986 S * 5/2011 Idsoe D3/208
 D674,808 S * 1/2013 Axelrod D14/480.3
 D720,096 S * 12/2014 McDougall D28/66
 D727,015 S * 4/2015 Arrindell D3/208
 D817,175 S * 5/2018 Gelov D9/529
 D819,440 S * 6/2018 Cunningham D9/420
 D820,584 S * 6/2018 Axelrod D3/203.1
 D841,010 S * 2/2019 Kong D14/435.1
 D886,453 S * 6/2020 Wright D3/294
 D888,041 S * 6/2020 Wright D14/250

D888,043 S * 6/2020 Wright D14/250
 D888,408 S * 6/2020 Lee D3/201
 2005/0216639 A1* 9/2005 Sparer G06F 21/78
 710/305

OTHER PUBLICATIONS

Responder Keychain USB Medical Alert ID, UniversalMedicalData.com, [online], [site visited Sep. 14, 2020]. <URL: <https://universalmedicaldata.com/product/responder-keychain-usb-medical-alert-id-free-ship/>> (Year: 2020).*

#USBSK USB Medi Chip Skinny Medical Alert Necklace, MedicalIDstore.com, [online], [site visited Sep. 14, 2020]. <URL: https://www.medicalidstore.com/inc/sdetail/_usbsk_usb_medi_chip_skinny_medical_alert_necklace_/950/133> (Year: 2020).*

Key 2 Life EMR Medi-Chip Mini USB Necklace with Crystal—Silver Colored, ElegantMedicalAlert.com, [online], [site visited Sep. 14, 2020]. <URL: <https://www.elegantmedicalalert.com/Key2Life-USB-Medi-Chip-Mini-Necklace-Silver-Colored.html>> (Year: 2020).*

* cited by examiner

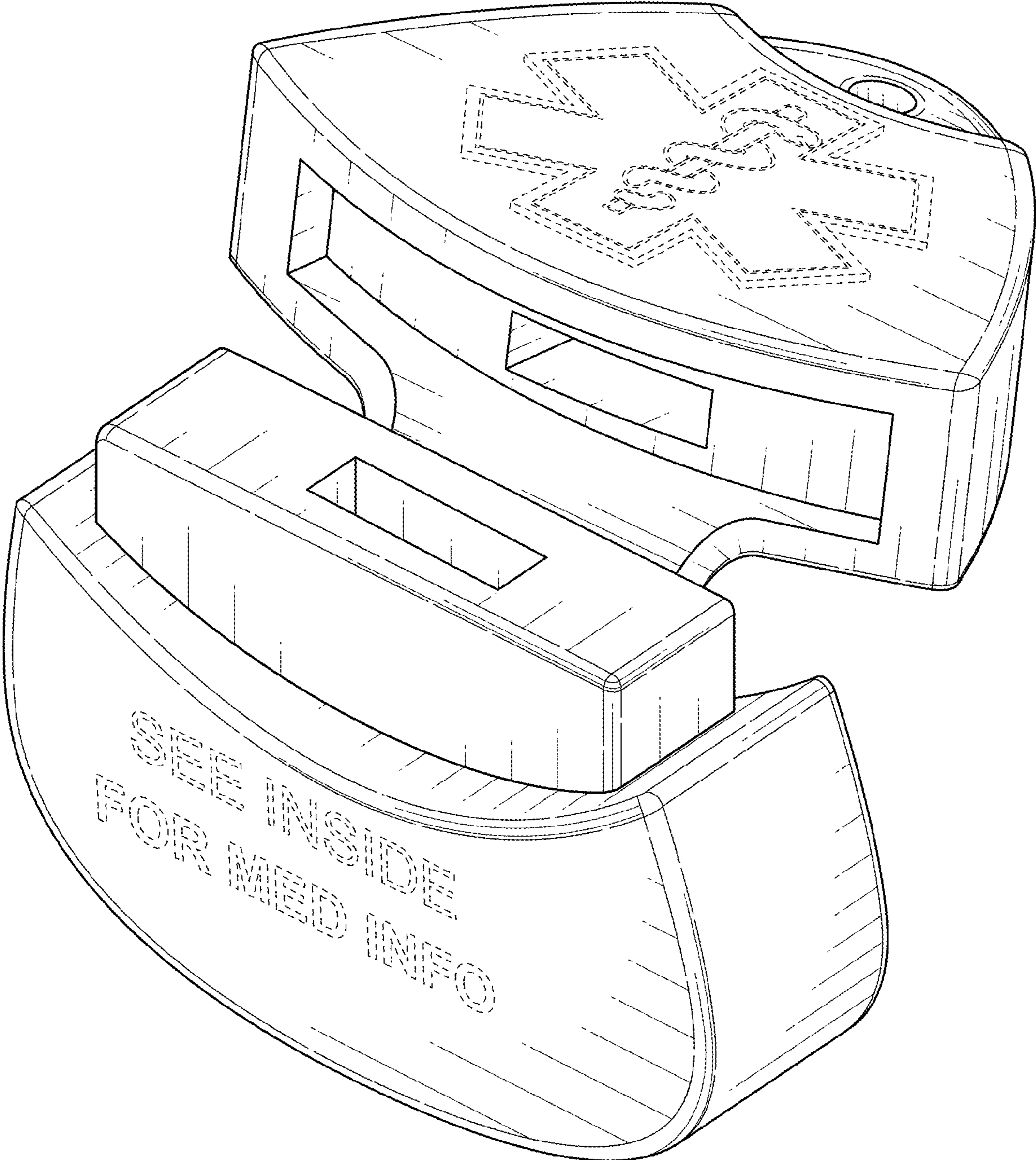

FIG. 1

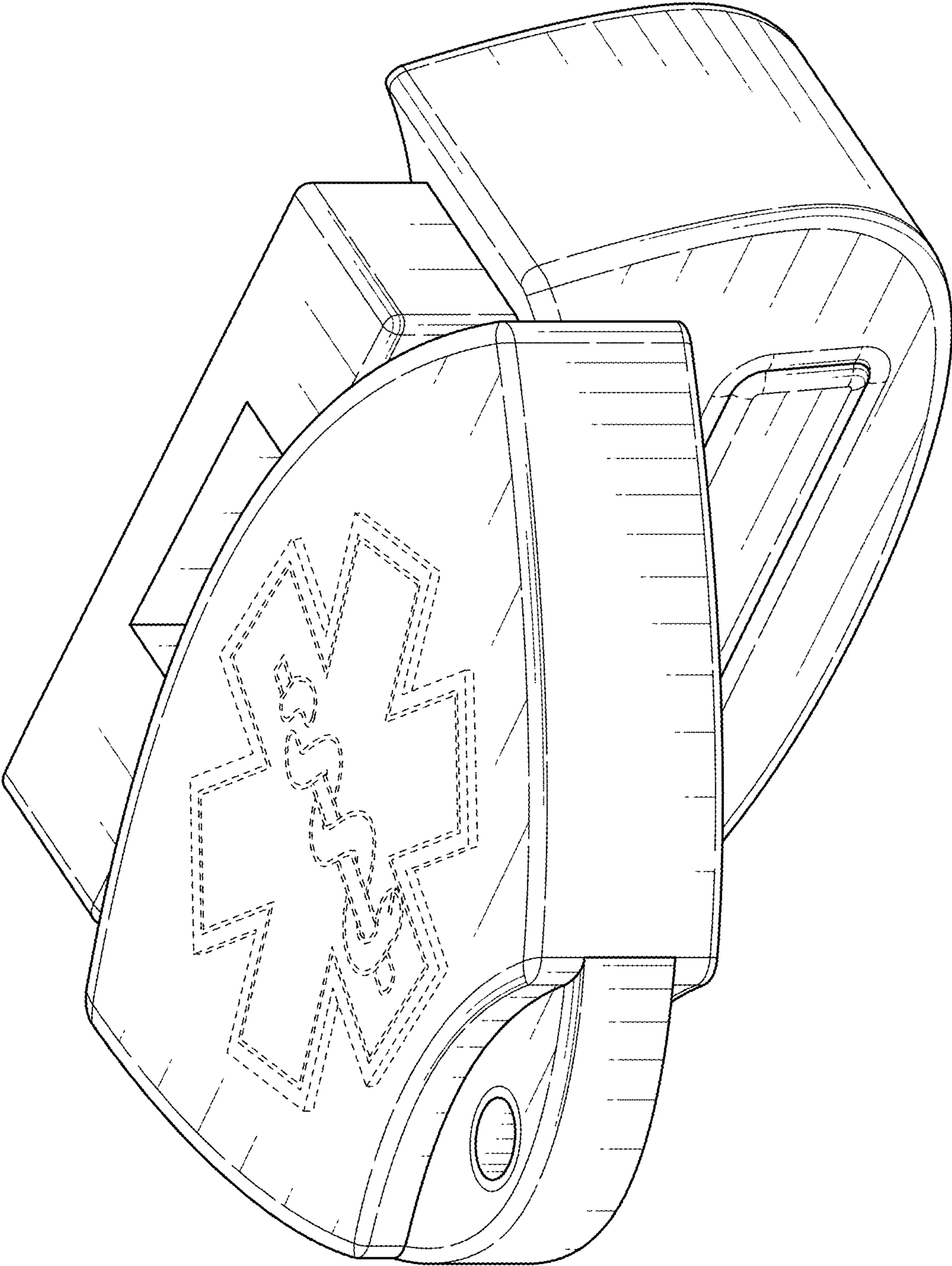

FIG. 2

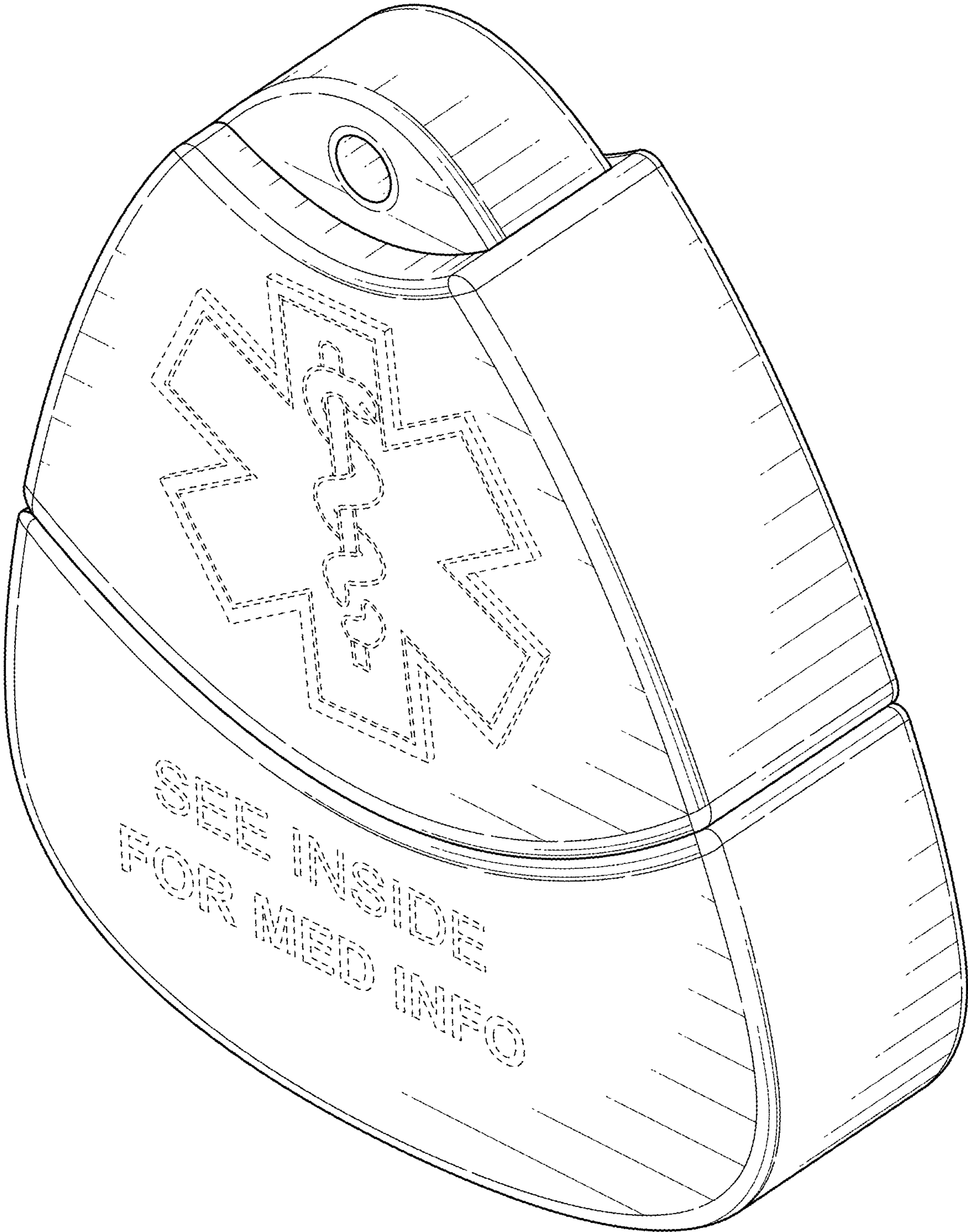

FIG. 3

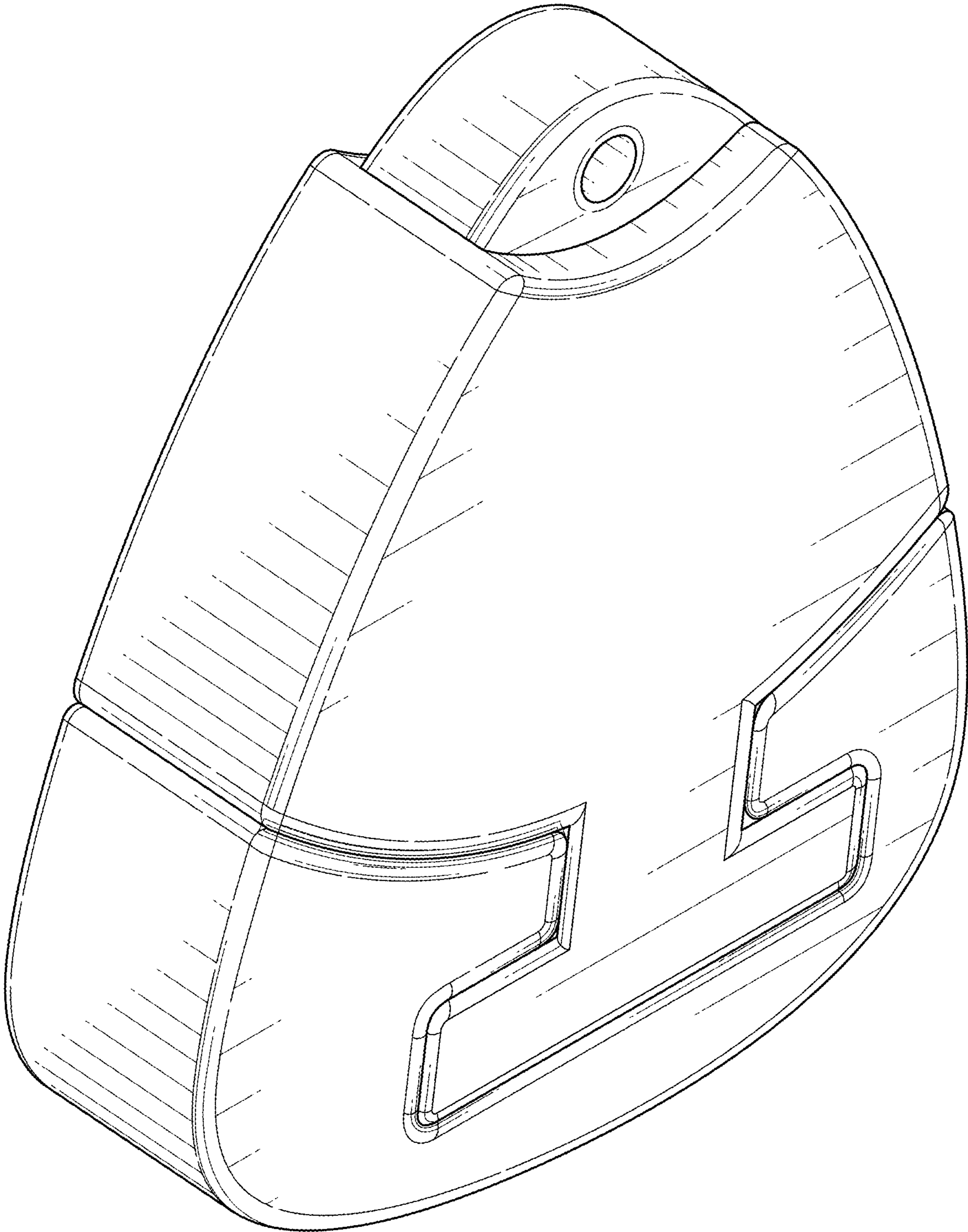

FIG. 4



FIG. 5

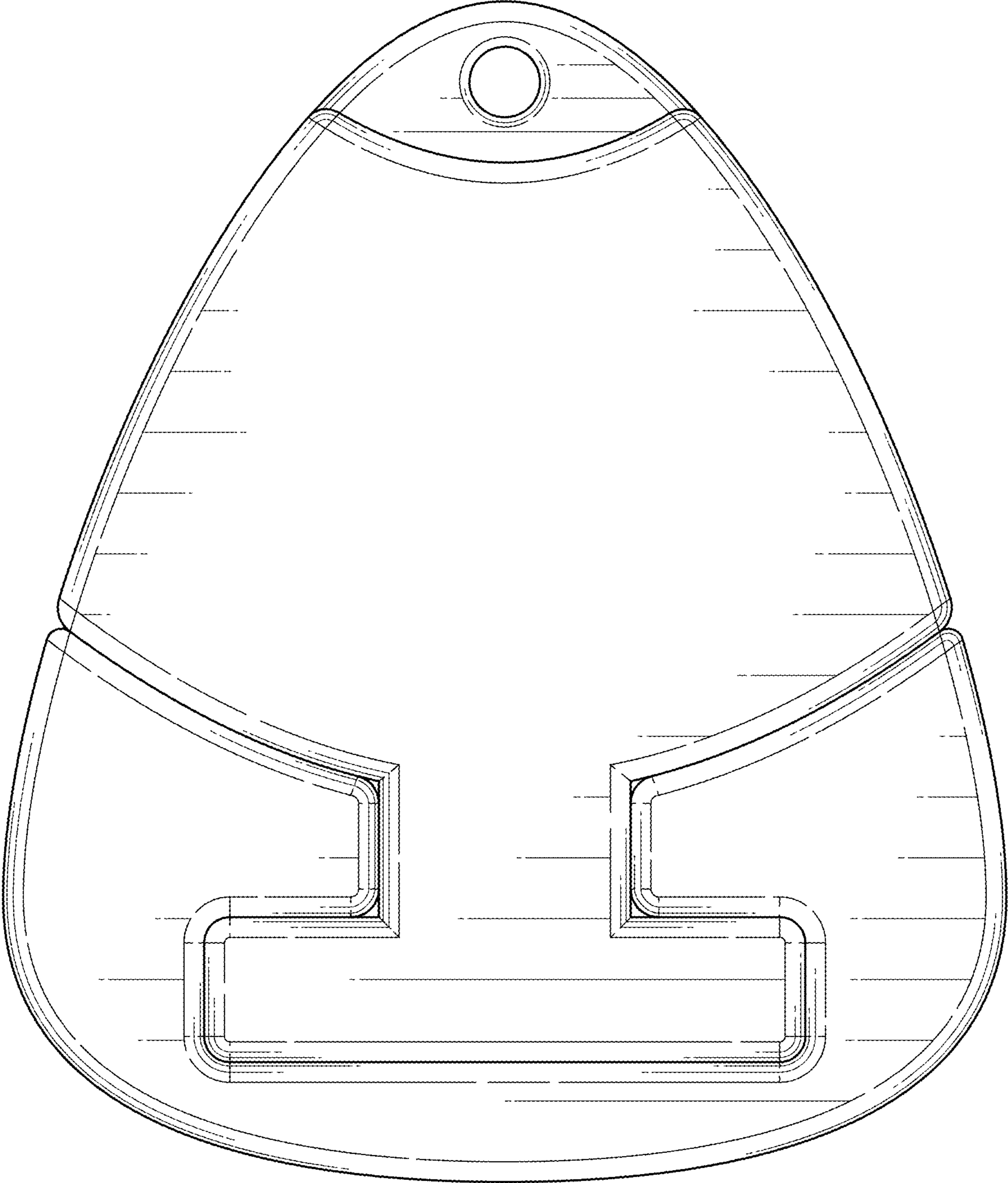

FIG. 6

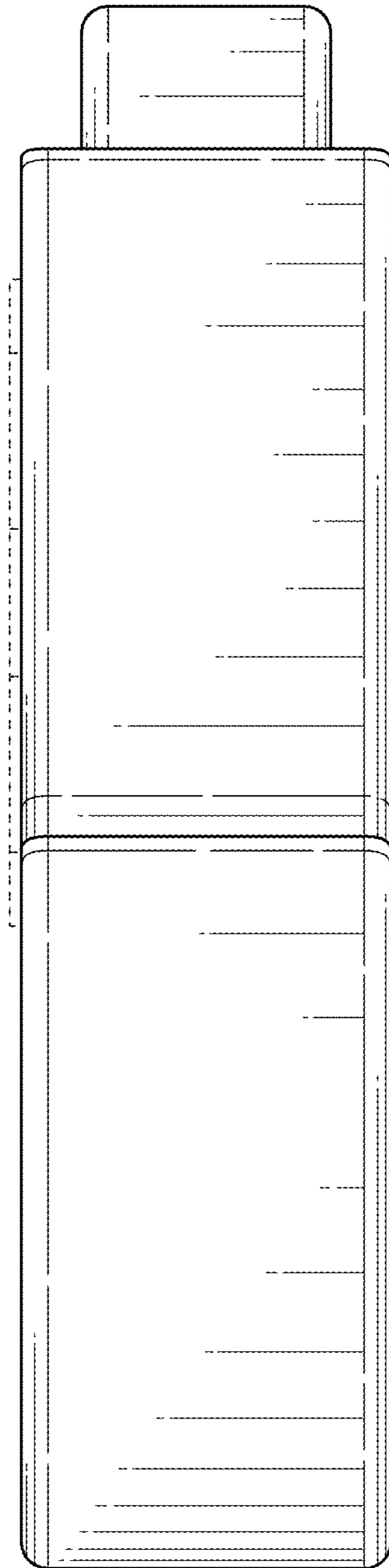

FIG. 7

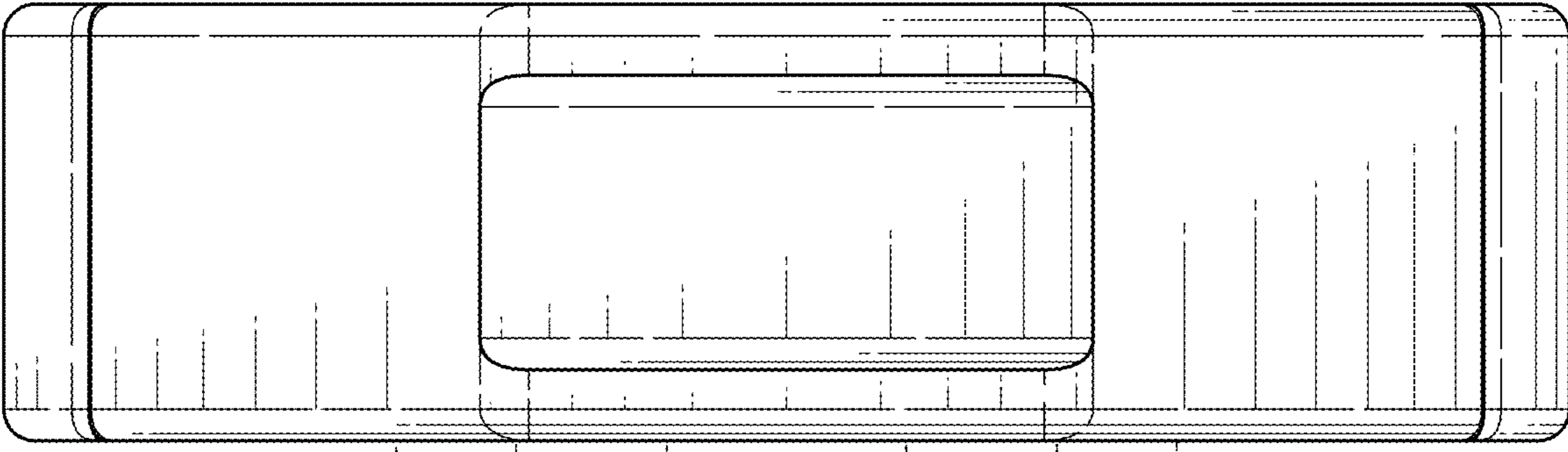

FIG. 8

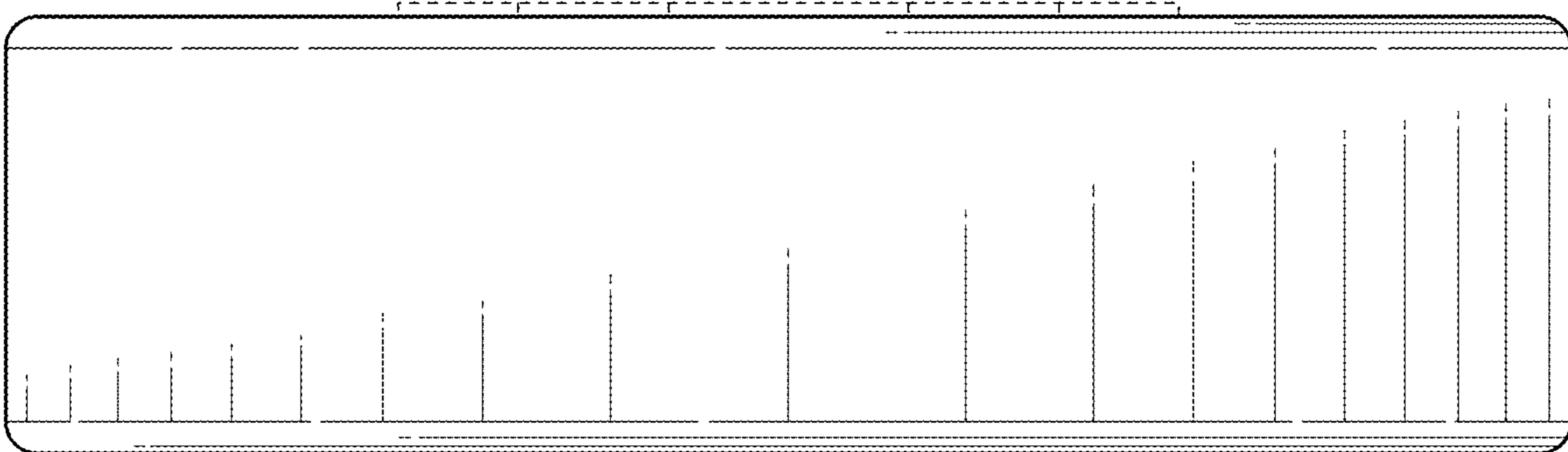

FIG. 9