



US00D901126S

(12) **United States Design Patent**
Luo et al.

(10) **Patent No.:** **US D901,126 S**

(45) **Date of Patent:** **** Nov. 10, 2020**

(54) **CONFECTIONERY PIECE**

(71) Applicant: **WM. WRIGLEY JR. COMPANY,**
Chicago, IL (US)

(72) Inventors: **Qishan Luo,** Guangzhou (CN); **Lina Su,** Guangzhou (CN); **Jianchao Lu,** Guangzhou (CN)

(73) Assignee: **WM. WRIGLEY JR. COMPANY,**
Chicago, IL (US)

(**) Term: **15 Years**

(21) Appl. No.: **29/693,216**

(22) Filed: **May 31, 2019**

(51) **LOC (12) Cl.** **01-01**

(52) **U.S. Cl.**
USPC **D1/115; D1/127**

(58) **Field of Classification Search**
USPC D1/100–130, 199; 426/92, 94, 104, 134,
426/138, 143, 275, 277, 279, 281–284,
426/292, 295, 391, 496, 514, 566, 572,
426/660; D11/68, 79, 86, 117; D21/484,
D21/496; D23/411, 413; D28/8.1, 8.2;
D7/544; D30/111; D6/597, 600;
D24/101–104
CPC .. A21D 2/16; A21D 2/36; A23L 1/164; A23L
1/217

See application file for complete search history.

(56) **References Cited**

U.S. PATENT DOCUMENTS

D166,561 S *	4/1952	Peters	D1/115
D167,583 S *	8/1952	Peters	D1/115
D215,248 S *	9/1969	Viitamen	D28/8.2
D290,576 S *	6/1987	Bird	D32/35
D346,325 S *	4/1994	Mansau	D9/658
D388,235 S *	12/1997	Wilson	D1/115
D509,641 S *	9/2005	Kerdoon	D1/115
D517,685 S *	3/2006	Frampton	D23/413

D615,728 S *	5/2010	Berrong	D1/128
D619,240 S *	7/2010	Swagler	D24/101
D666,910 S *	9/2012	Modha	D9/451
D821,684 S *	7/2018	Piccoli	D1/115
D822,332 S *	7/2018	Angeloni	D1/127

* cited by examiner

Primary Examiner — Katie Jane Stofko

(57) **CLAIM**

The ornamental design for a confectionery piece, as substantially shown and described.

DESCRIPTION

FIG. 1 is a front, right side, bottom perspective view of a first embodiment of a confectionery piece showing the present invention;

FIG. 2 is a front elevation view thereof;

FIG. 3 is a rear elevation view thereof;

FIG. 4 is a right side elevation view thereof;

FIG. 5 is a left side elevation view thereof;

FIG. 6 is a top plan view thereof;

FIG. 7 is a bottom plan view thereof;

FIG. 8 is a rear, right side, top perspective view thereof;

FIG. 9 is a front, right side, bottom perspective view of a second embodiment of a confectionery piece showing the present invention;

FIG. 10 is a front elevation view thereof;

FIG. 11 is a rear elevation view thereof;

FIG. 12 is a right side elevation view thereof;

FIG. 13 is a left side elevation view thereof;

FIG. 14 is a top plan view thereof;

FIG. 15 is a bottom plan view thereof; and,

FIG. 16 is a rear, right side, top perspective view thereof.

The ornamental design which is claimed is shown in solid lines in the drawings.

The stippled shading and the and the areas not showing stippled shading shown in FIGS. 1-8 represent a contrasting appearance.

1 Claim, 10 Drawing Sheets

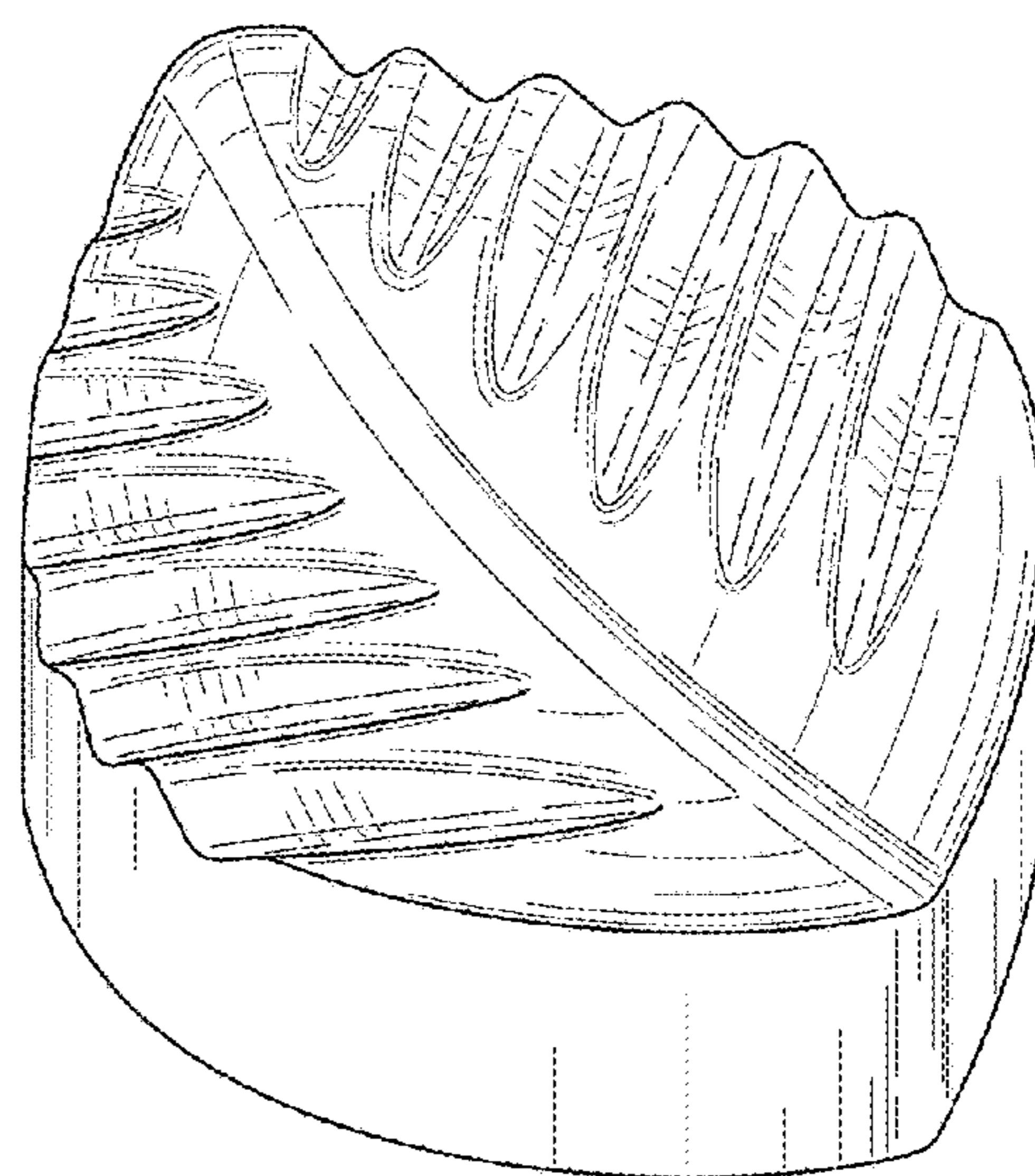
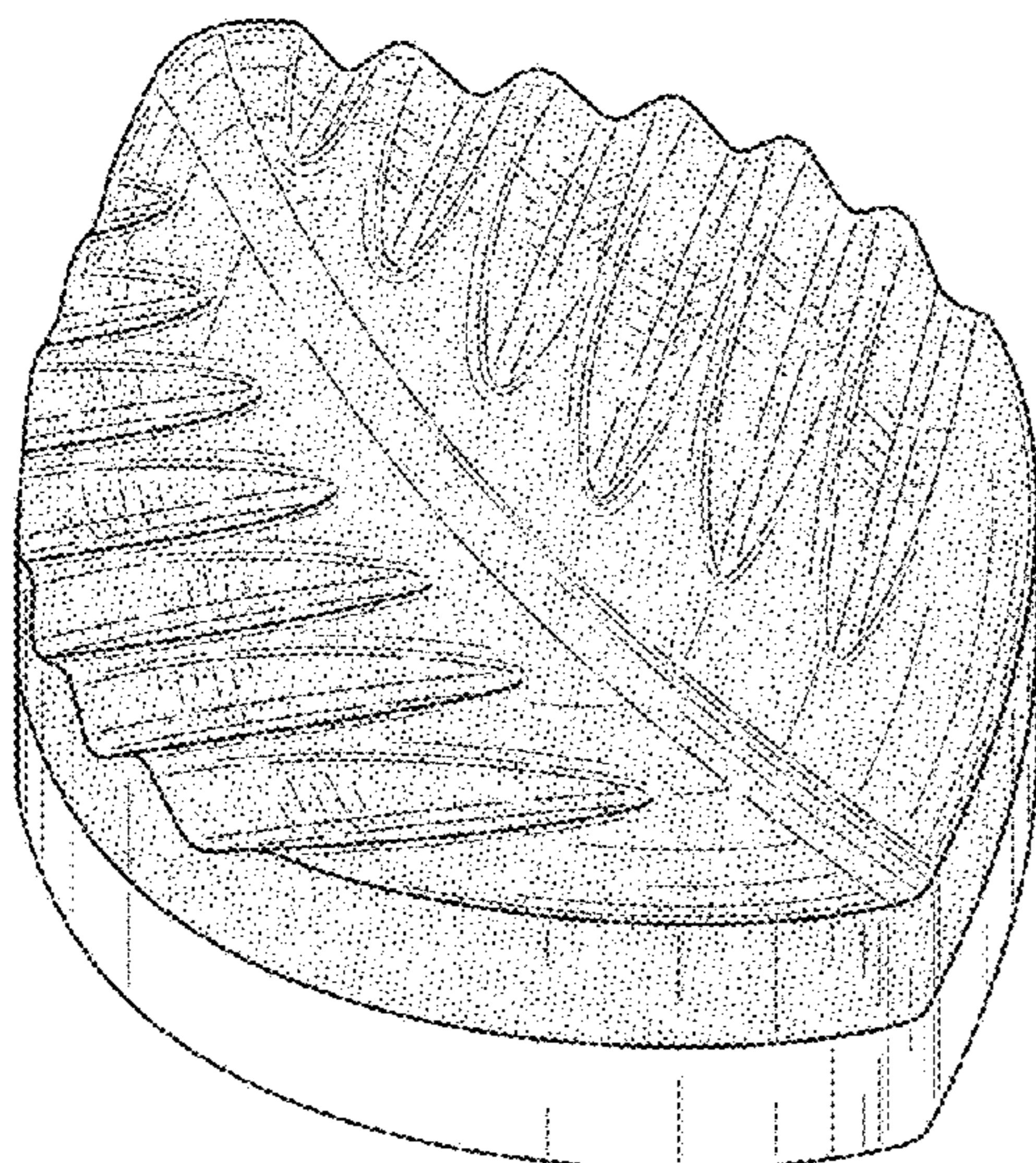

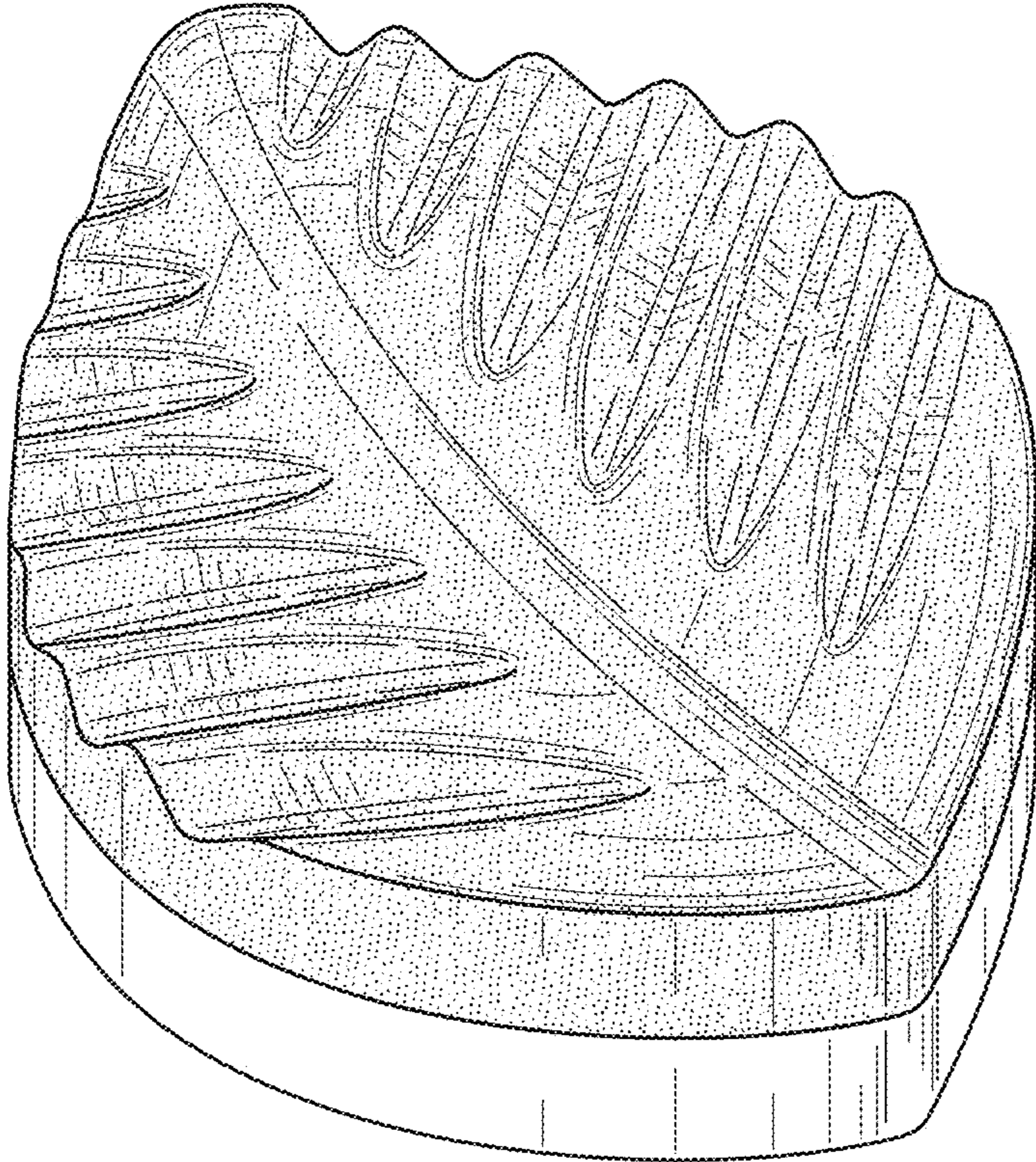

FIG. 1

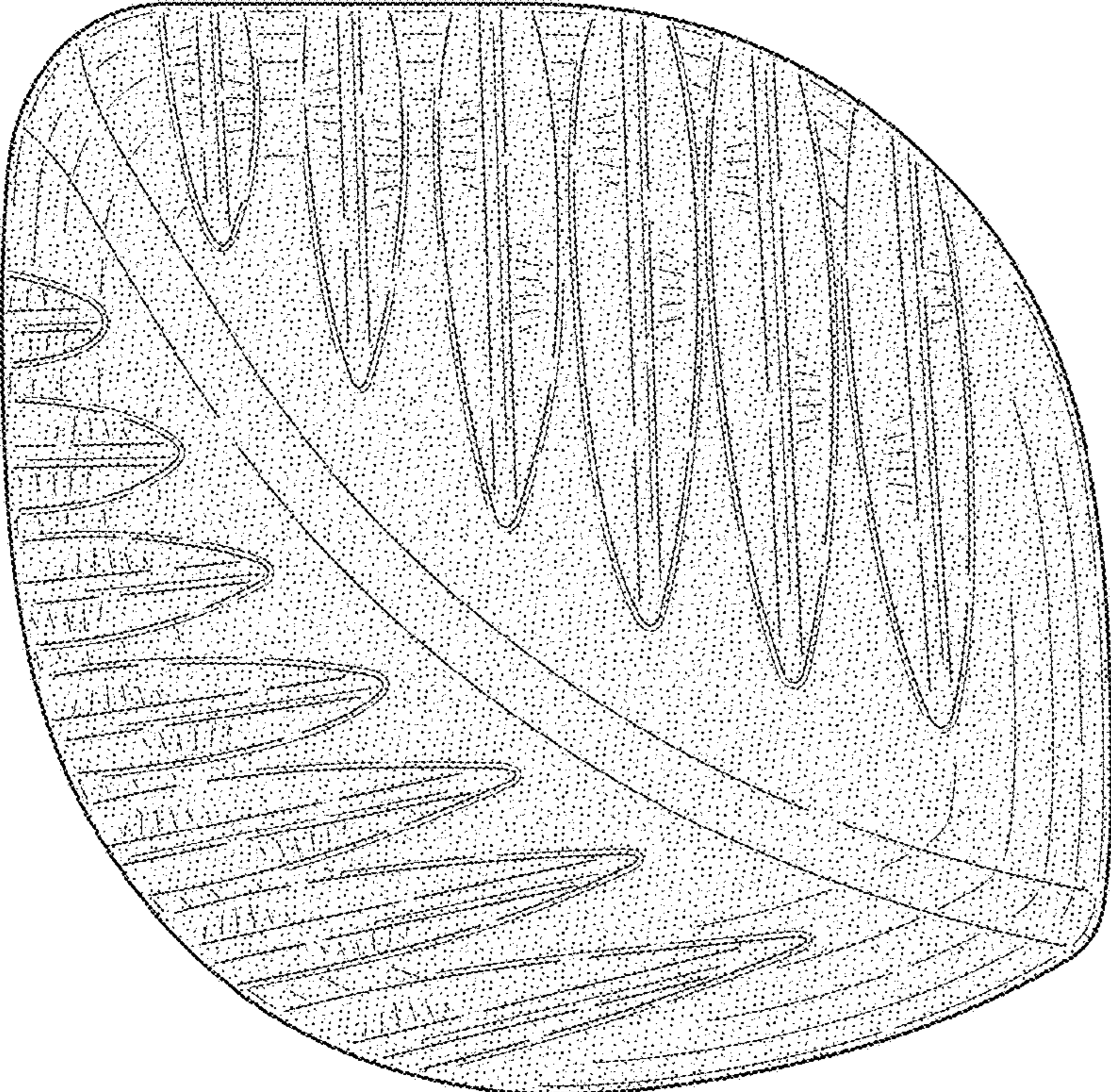

FIG. 2

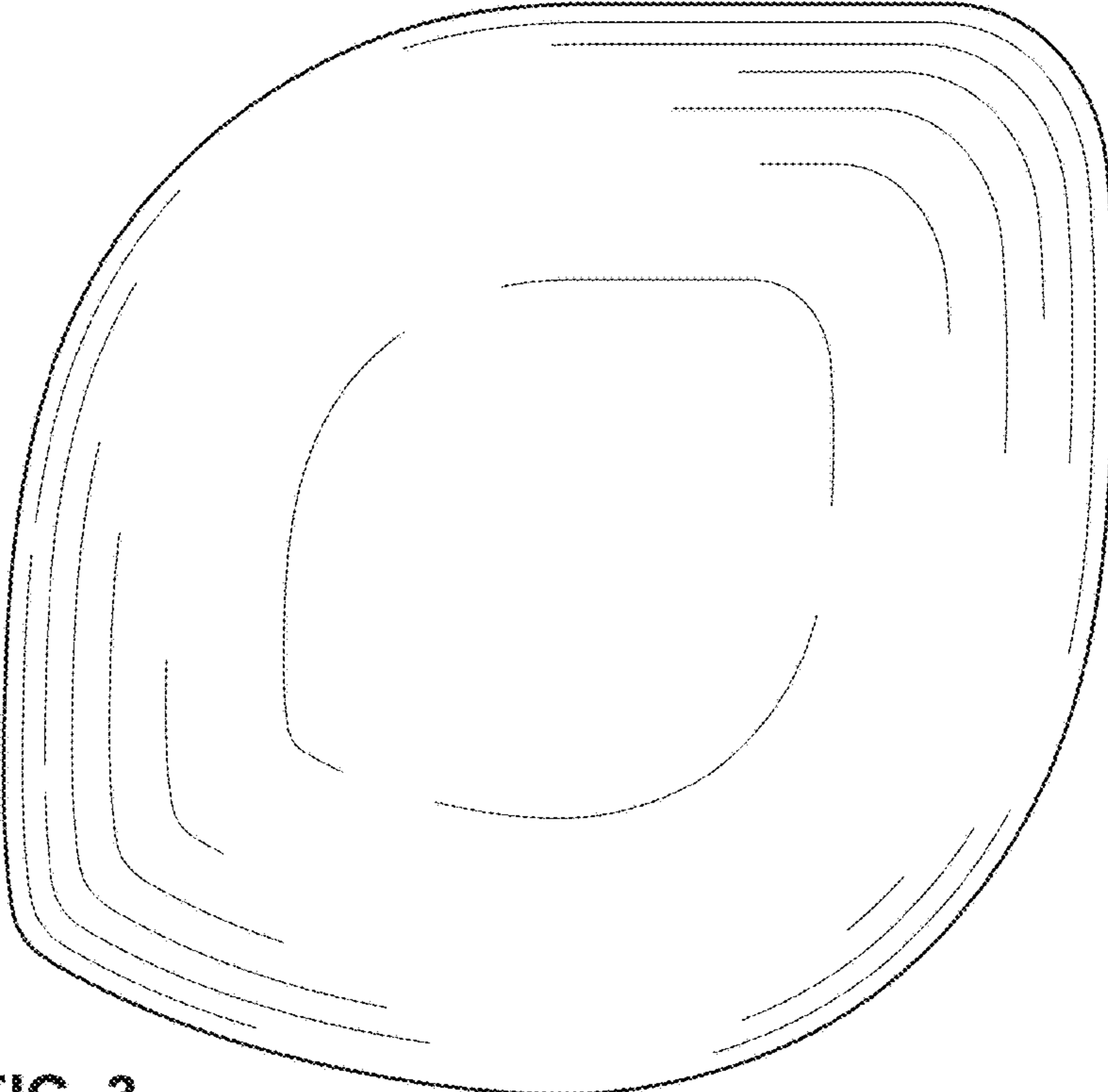

FIG. 3

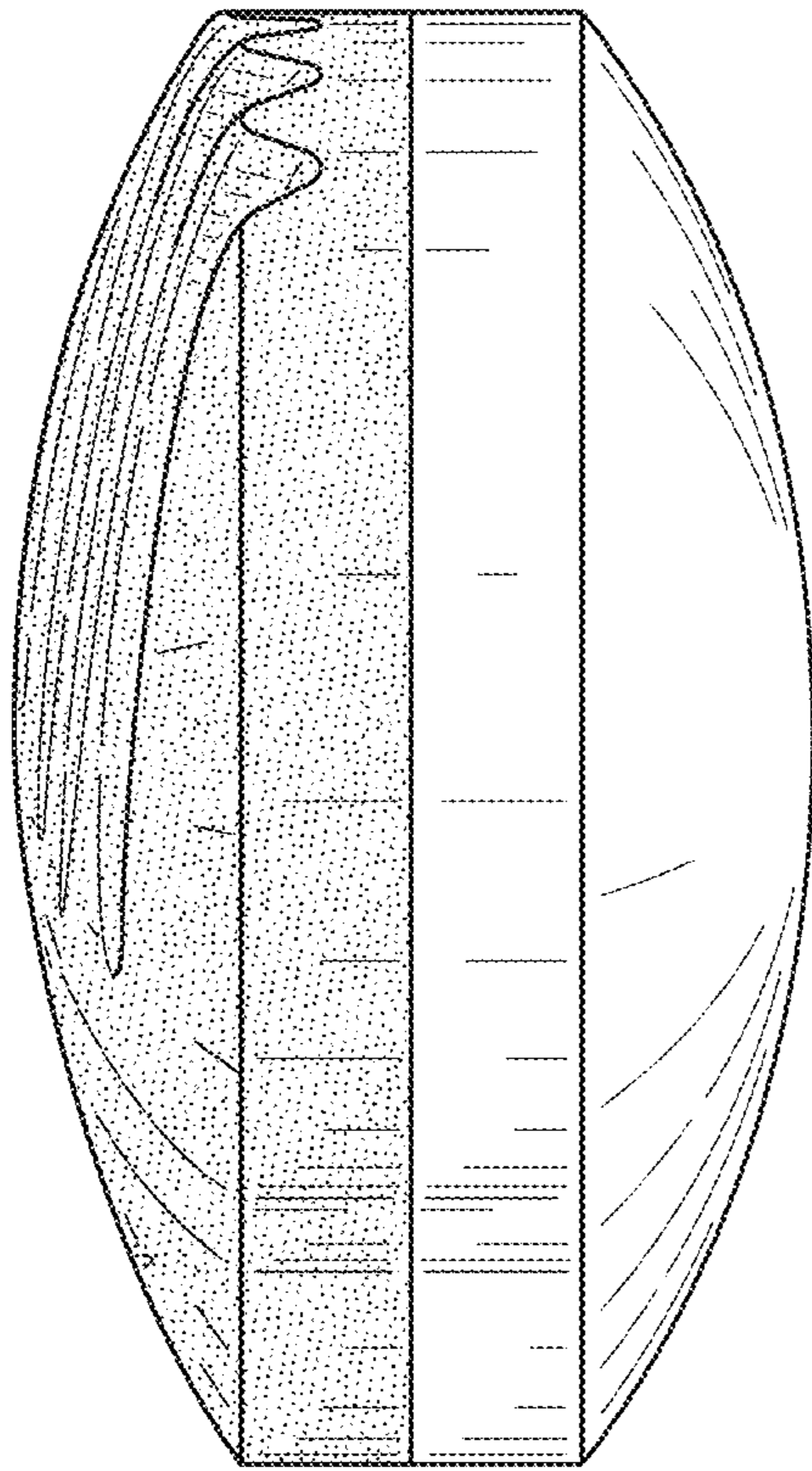

FIG. 4

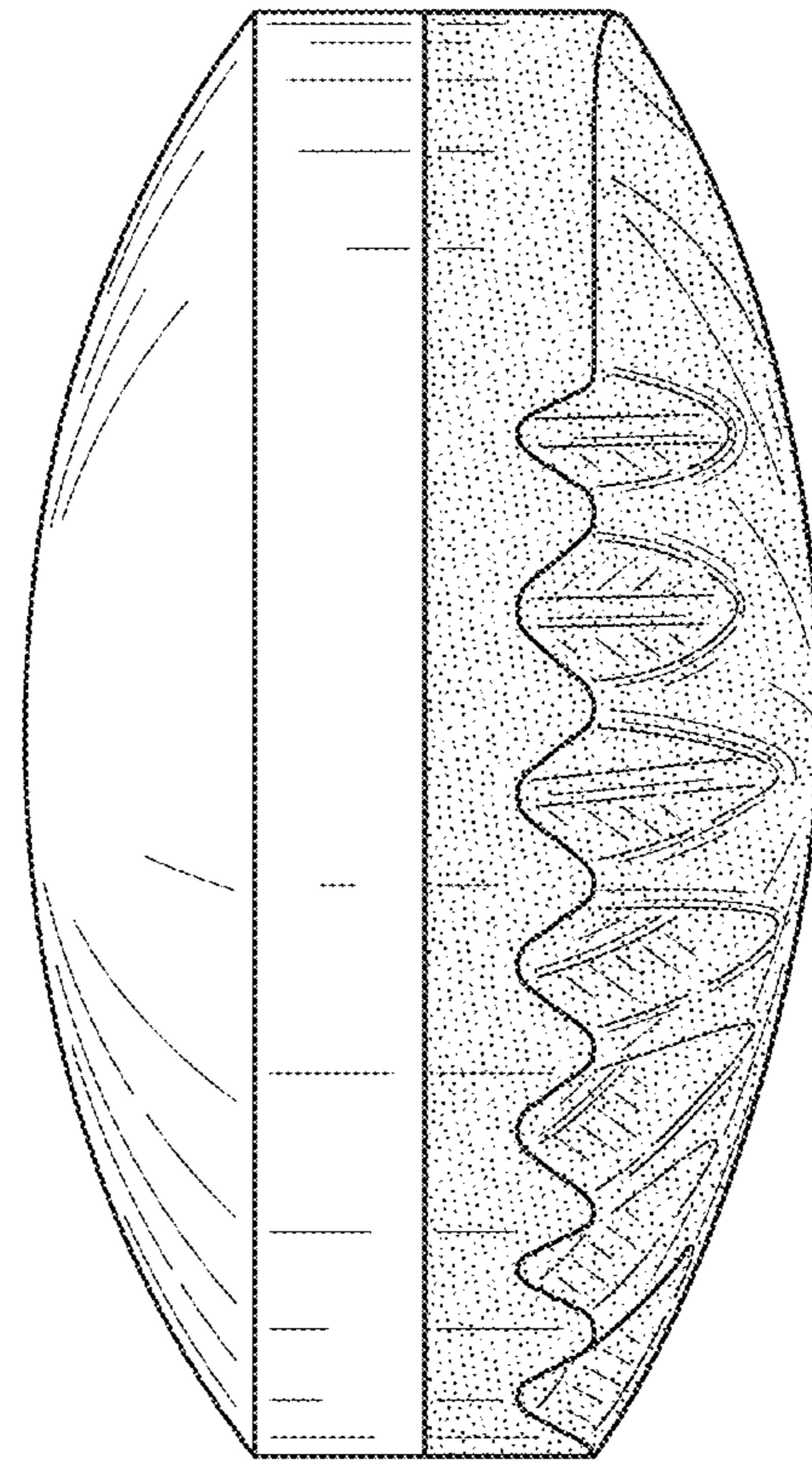

FIG. 5

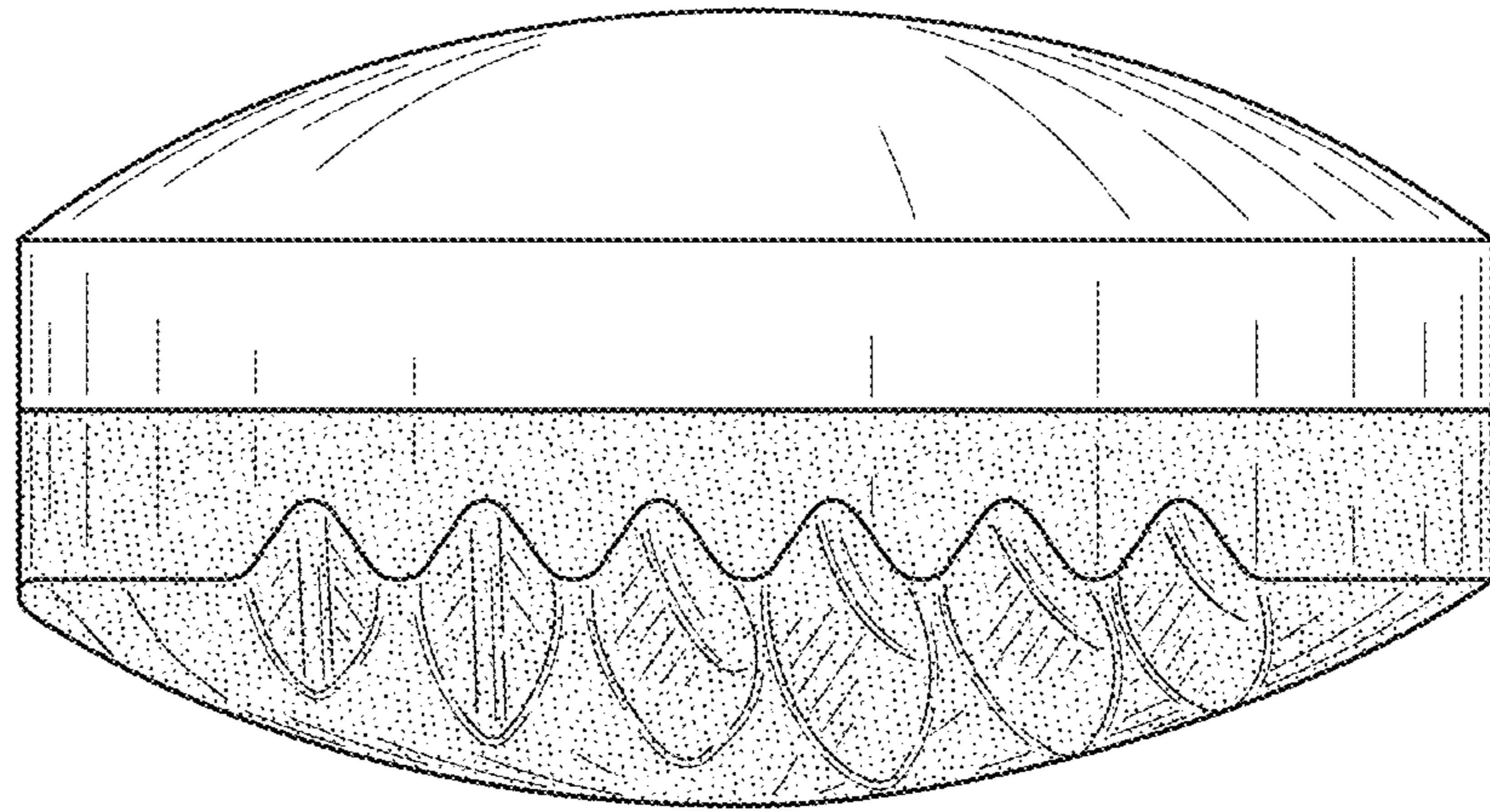

FIG. 6

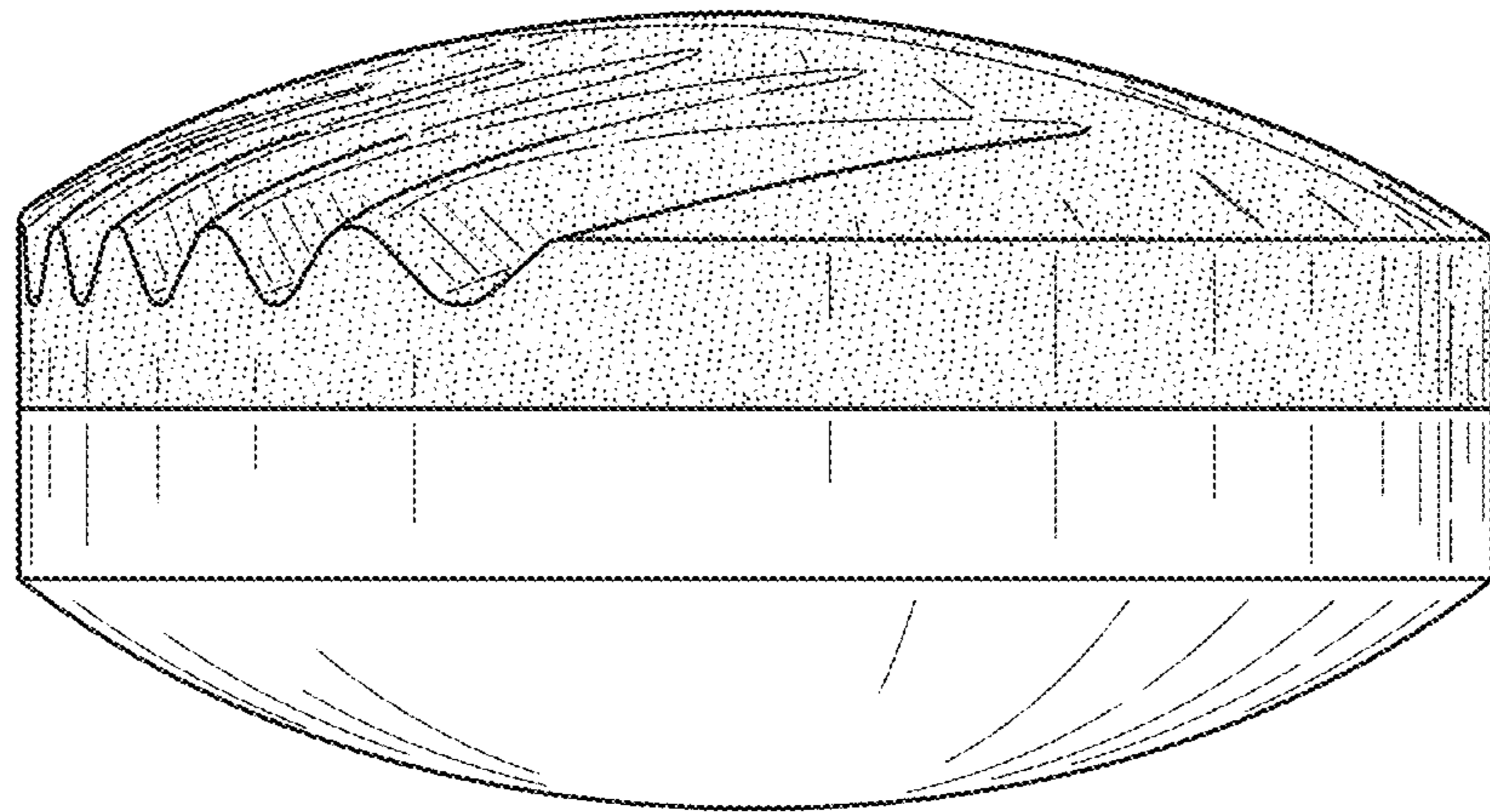

FIG. 7

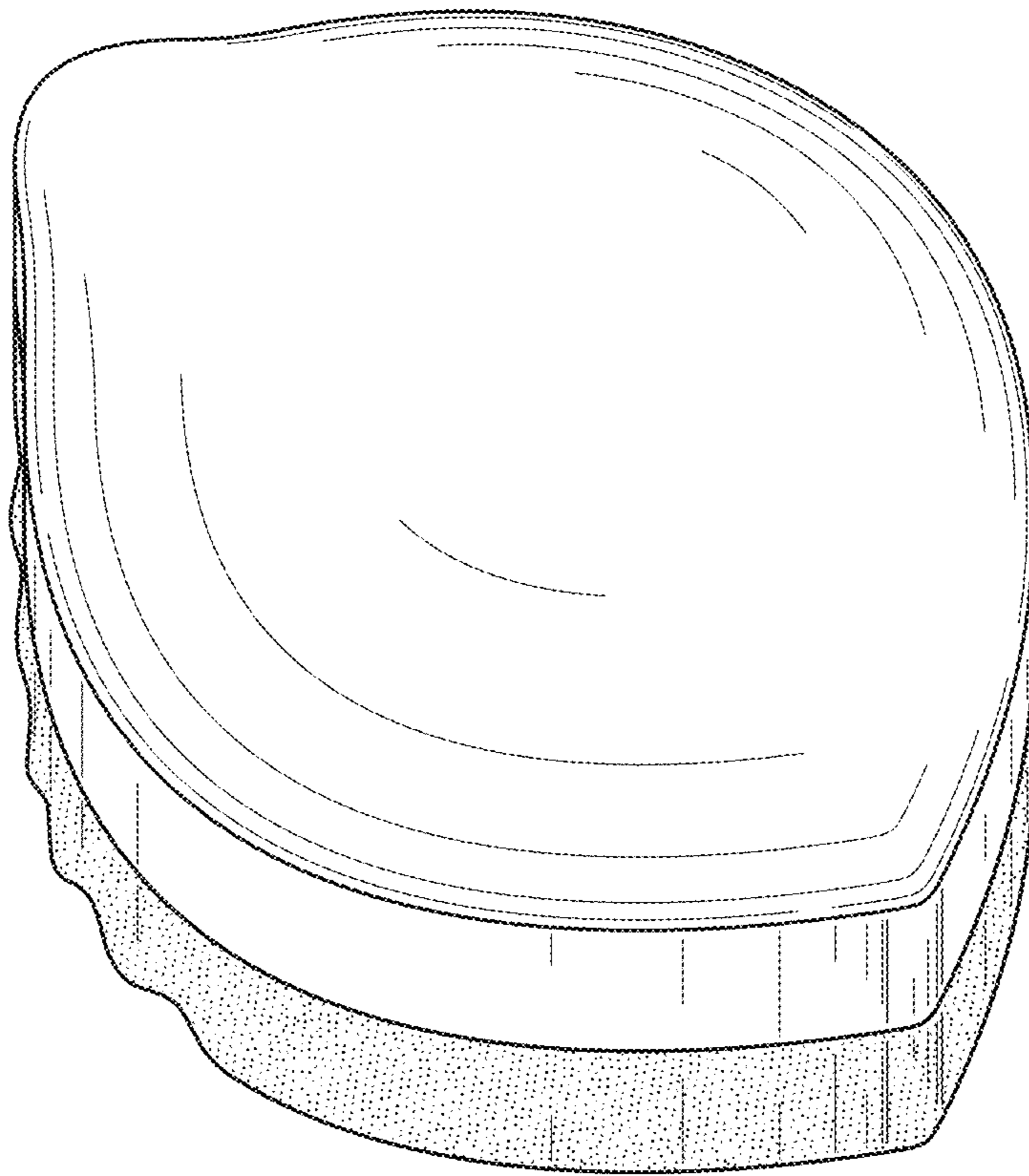

FIG. 8

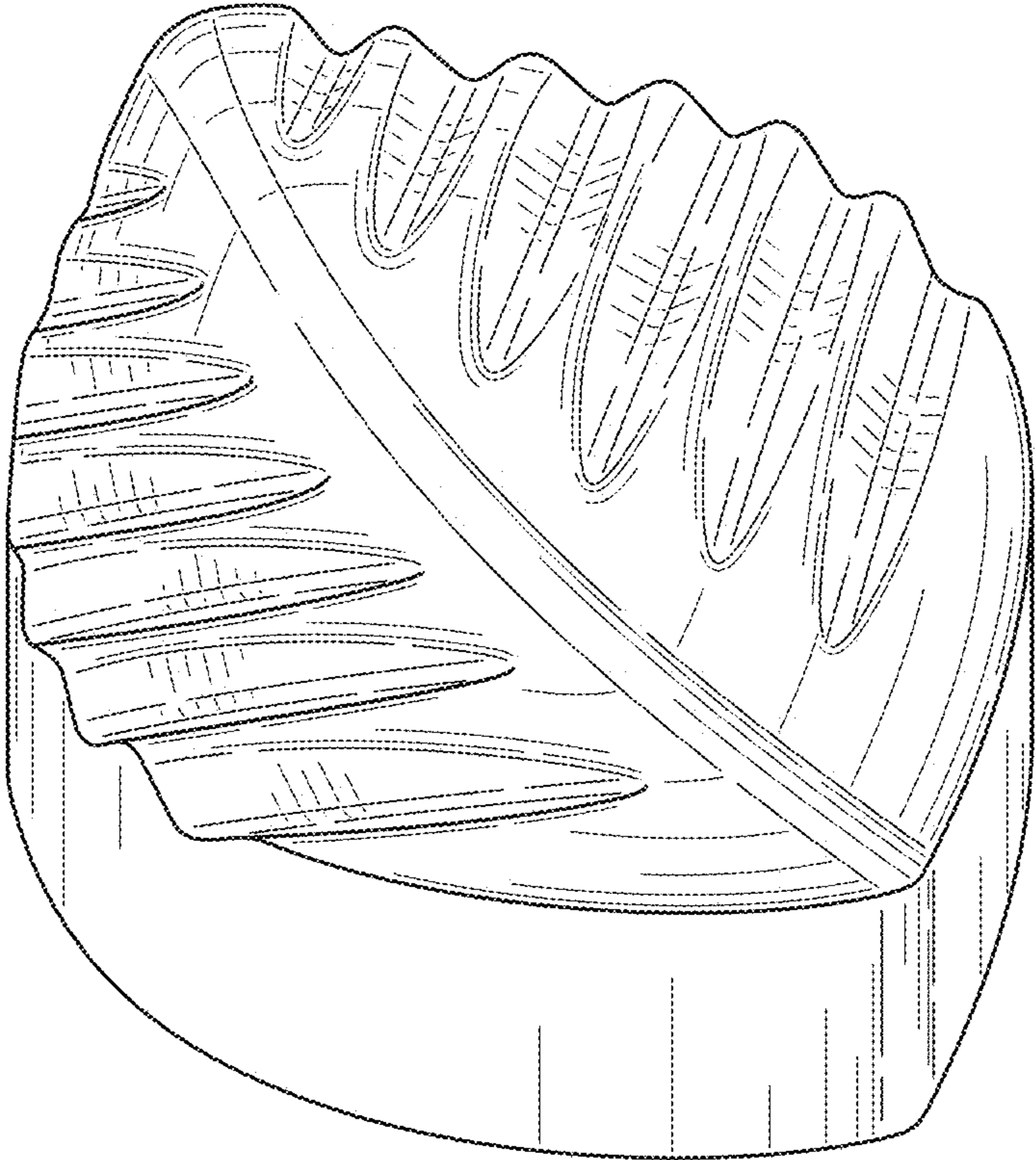

FIG. 9

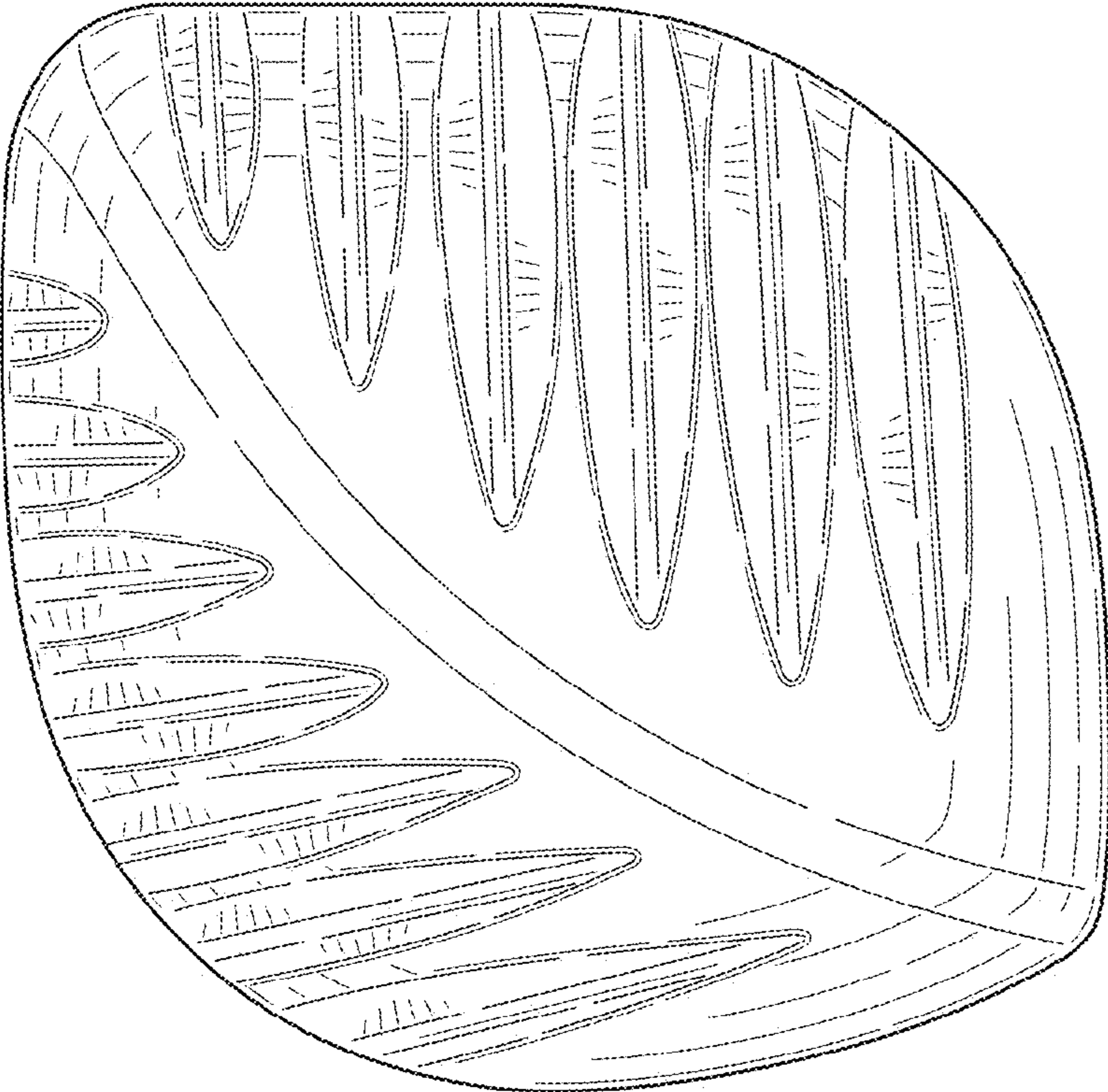

FIG. 10

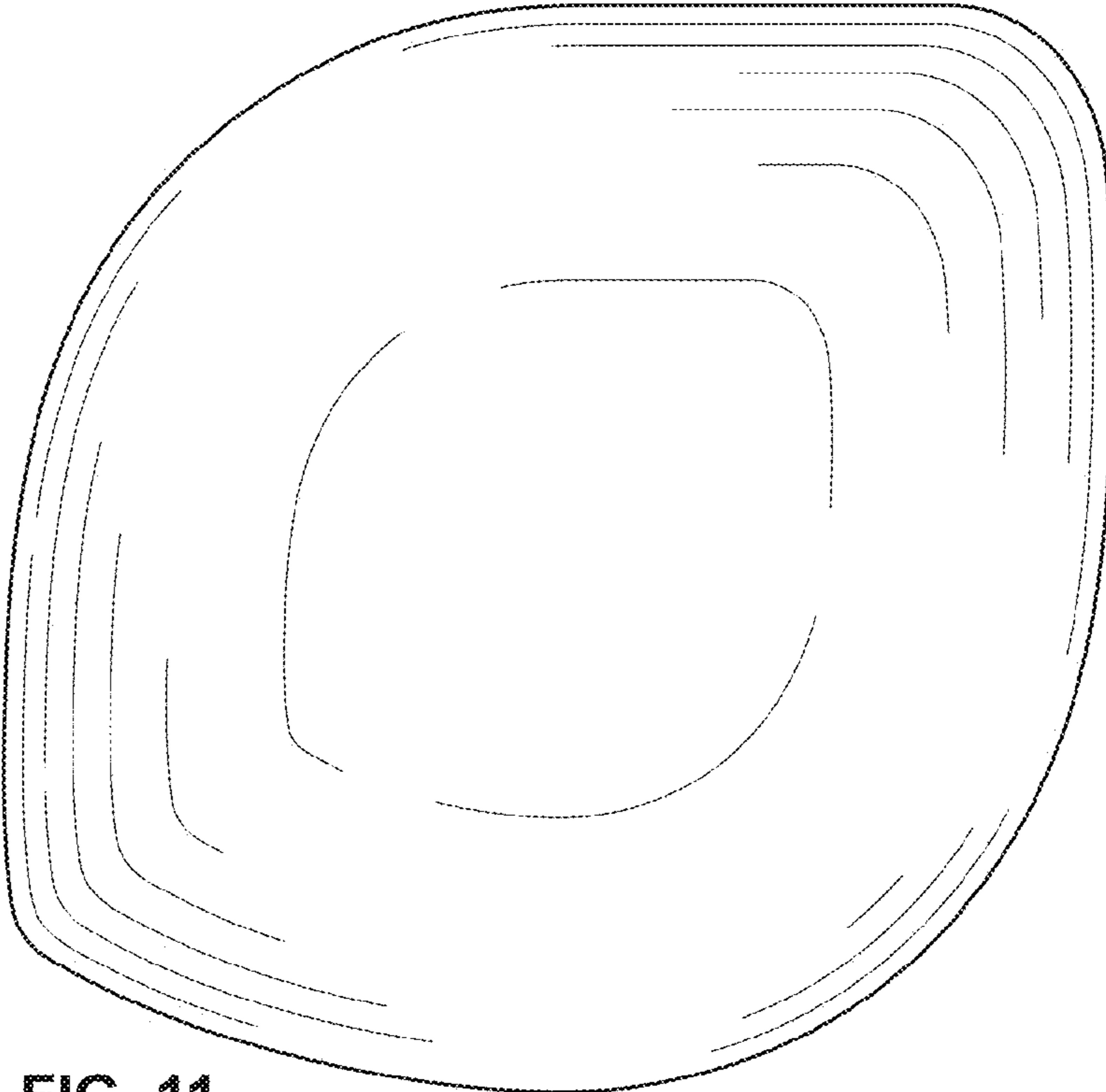

FIG. 11

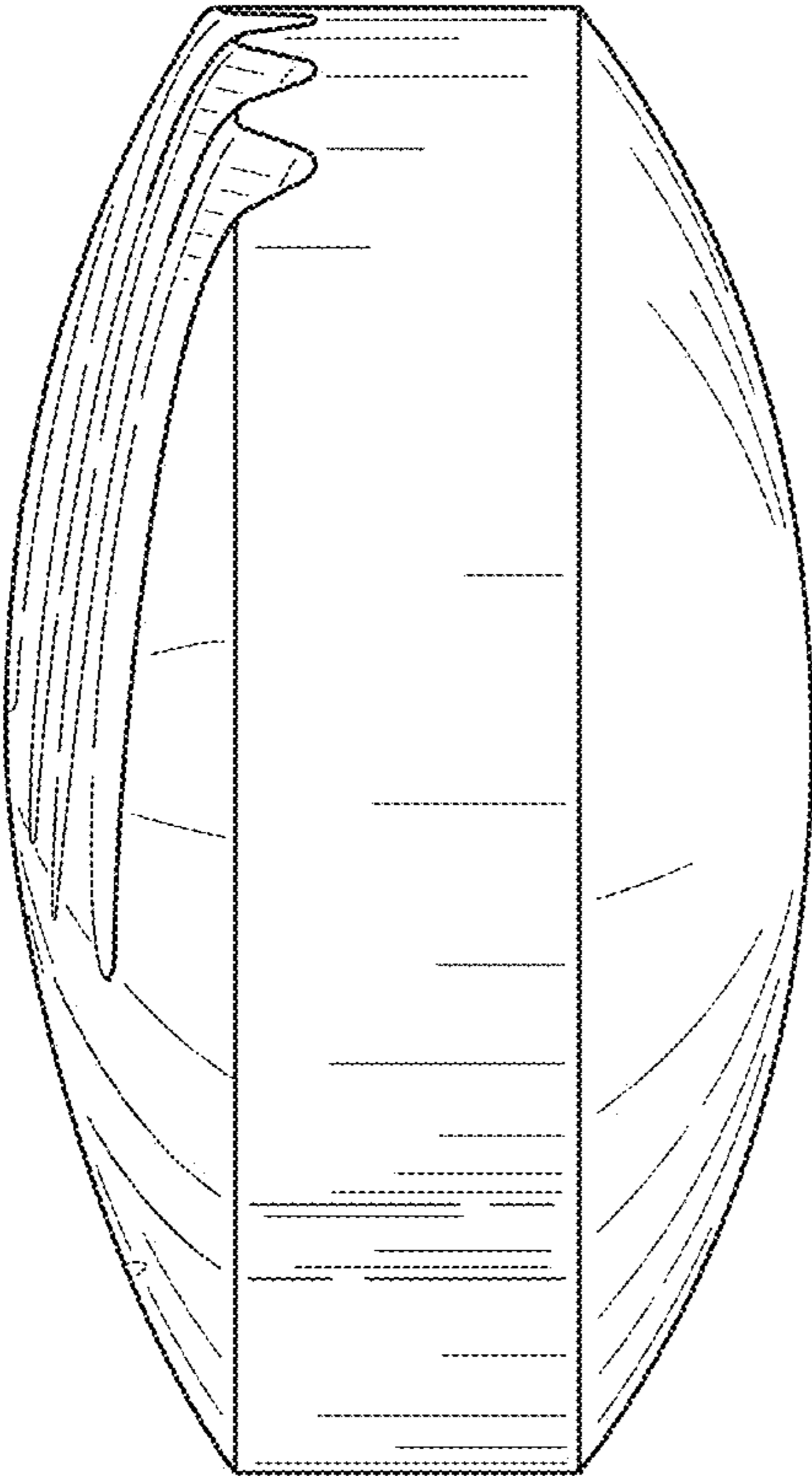

FIG. 12

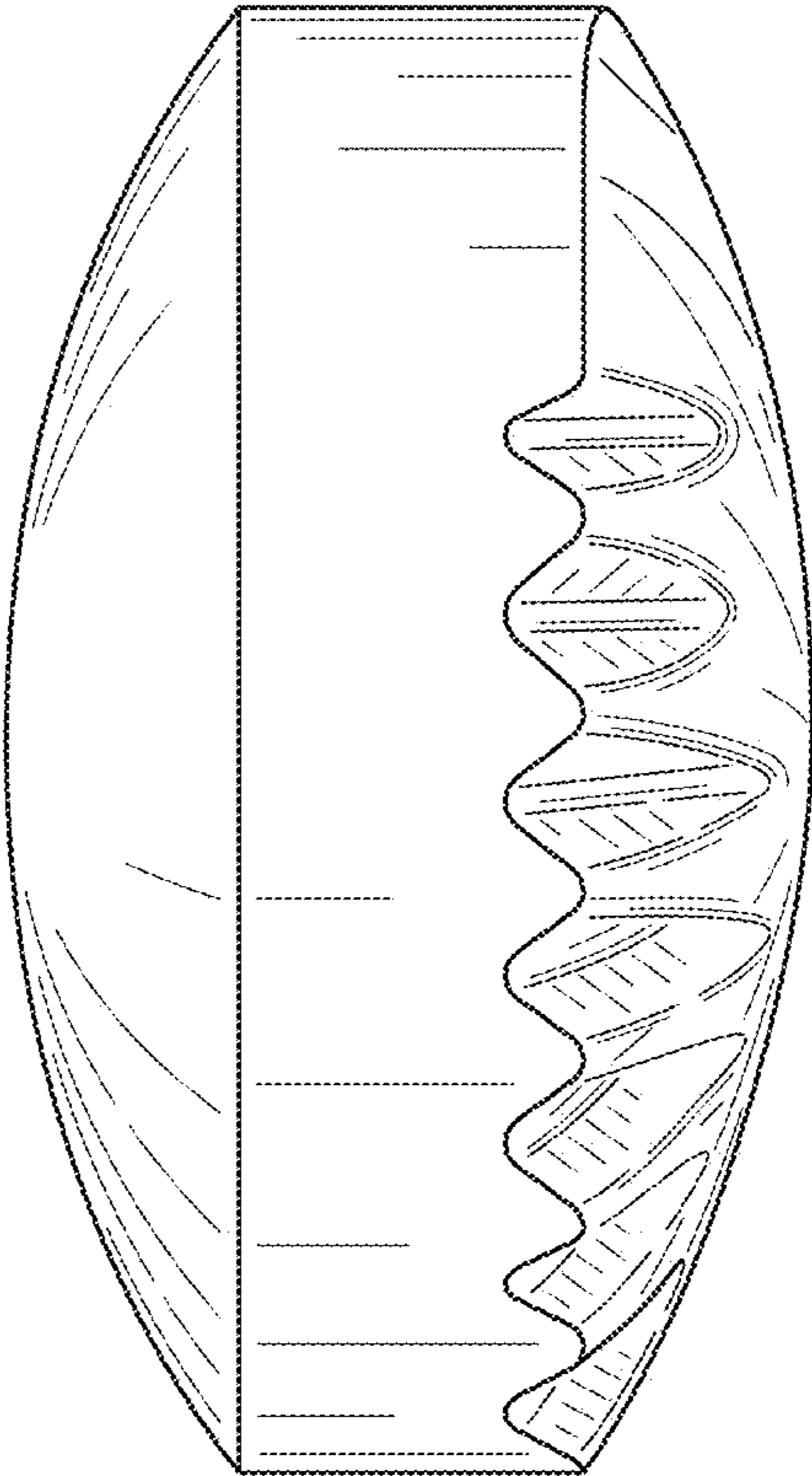

FIG. 13

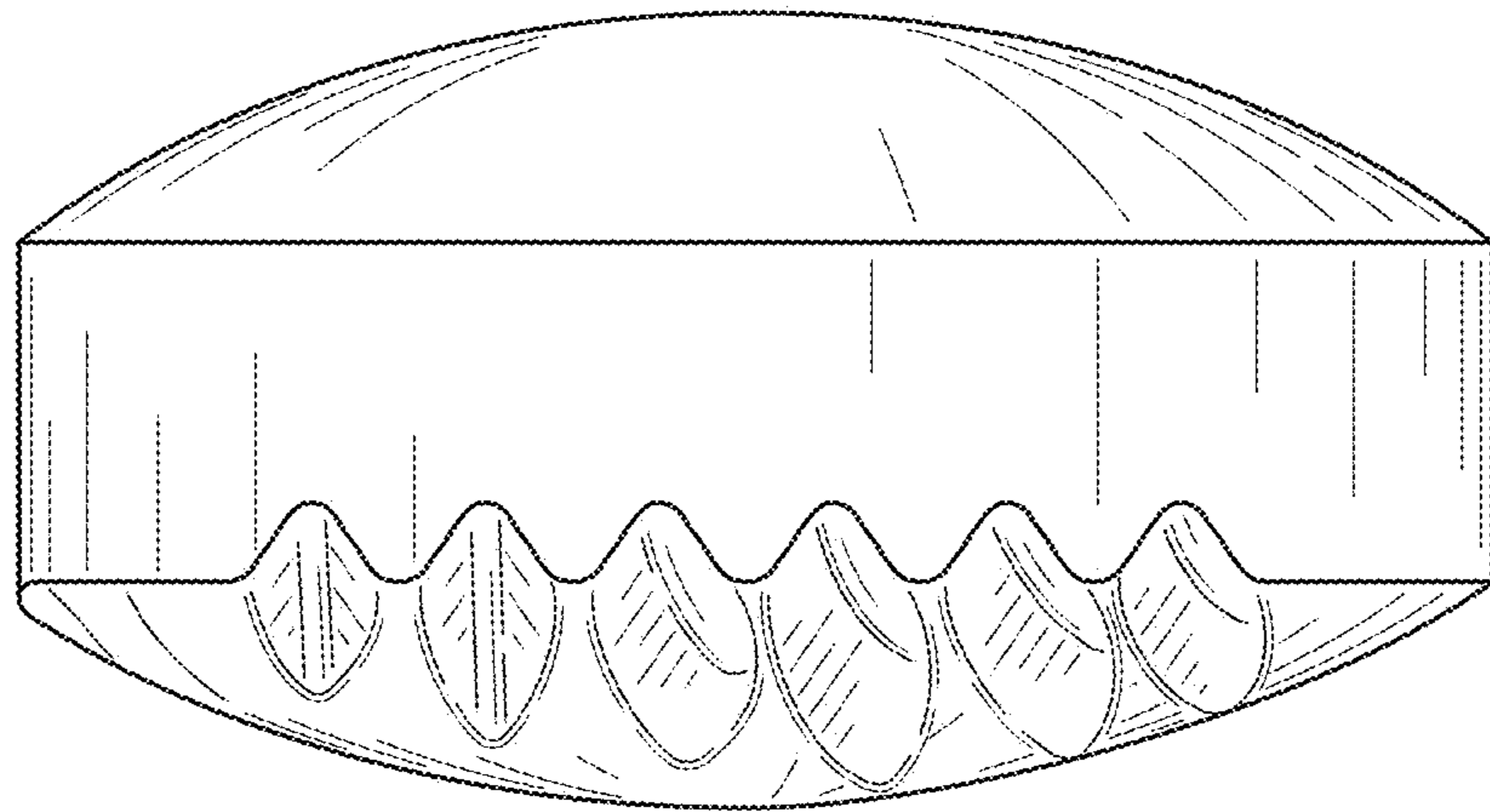

FIG. 14

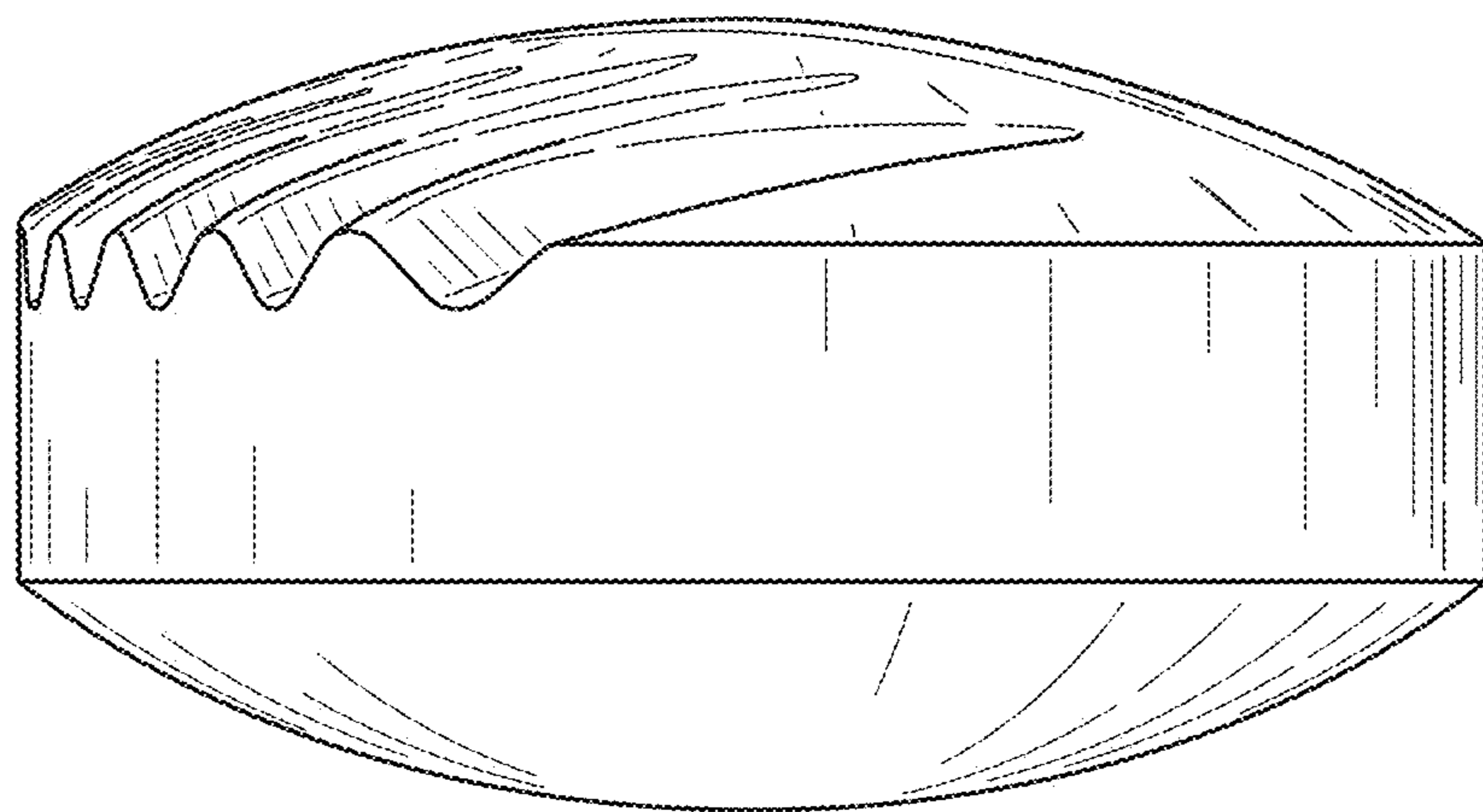

FIG. 15

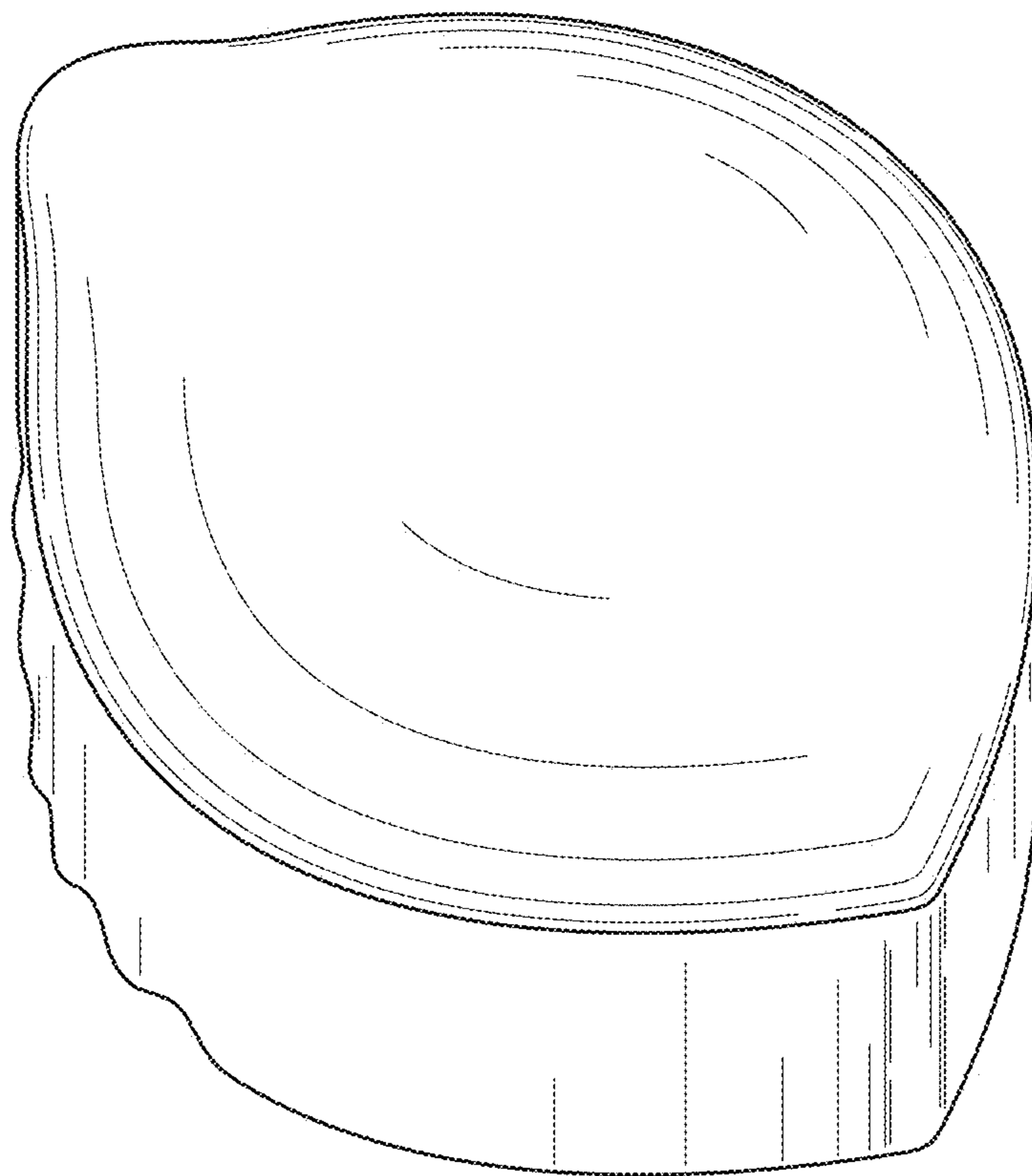

FIG. 16