

US00D900982S

(12) **United States Design Patent**
Rosario

(10) **Patent No.:** **US D900,982 S**

(45) **Date of Patent:** **** Nov. 3, 2020**

(54) **DRAIN STOPPER WITH DEBRIS CATCH**

(71) Applicant: **Israel Rosario**, Davie, FL (US)

(72) Inventor: **Israel Rosario**, Davie, FL (US)

(**) Term: **15 Years**

(21) Appl. No.: **29/706,270**

(22) Filed: **Sep. 19, 2019**

(51) **LOC (12) Cl.** **23-01**

(52) **U.S. Cl.**
USPC **D23/261**

(58) **Field of Classification Search**
USPC D23/269–262; 210/163–164; 4/286–295,
4/679, 613, 689, 684
CPC E02D 31/02; E03F 3/046
See application file for complete search history.

2014/0007334 A1* 1/2014 Golibart E03C 1/262
4/287
2014/0165275 A1* 6/2014 Zito E03C 1/264
4/292
2014/0310862 A1* 10/2014 Joseph E03C 1/262
4/287
2016/0053472 A1* 2/2016 Rosko E03C 1/2302
4/287

* cited by examiner

Primary Examiner — Amy C Wierenga

(74) *Attorney, Agent, or Firm* — The Rapacke Law Group P.A.

(57) **CLAIM**

The ornamental design for a drain stopper with debris catch, as shown and described.

DESCRIPTION

FIG. 1 is a perspective view of the drain stopper with debris catch, showing the new design;
FIG. 2 is a front elevational view of the drain stopper with debris catch thereof;
FIG. 3 is a rear elevational view of the drain stopper with debris catch thereof;
FIG. 4 is a left side elevational view of the drain stopper with debris catch thereof;
FIG. 5 is a right side elevational view of the drain stopper with debris catch thereof;
FIG. 6 is a top plan view of the drain stopper with debris catch thereof; and,
FIG. 7 is a bottom plan view of the drain stopper with debris catch thereof.

(56) **References Cited**

U.S. PATENT DOCUMENTS

3,959,831 A * 6/1976 Hendricks E03C 1/264
4/287
4,380,834 A * 4/1983 Wentz E03C 1/23
4/286
D357,306 S * 4/1995 Lenox D23/260
7,610,635 B2 * 11/2009 Schultz E03C 1/30
4/294
D783,783 S * 4/2017 Yang D23/261
D817,463 S * 5/2018 Curley D23/260
2009/0151060 A1 * 6/2009 Zubillaga E03C 1/262
4/292
2009/0271919 A1 * 11/2009 Scorvo E03C 1/262
4/287
2010/0115689 A1 * 5/2010 Thompson E03C 1/264
4/287

1 Claim, 6 Drawing Sheets

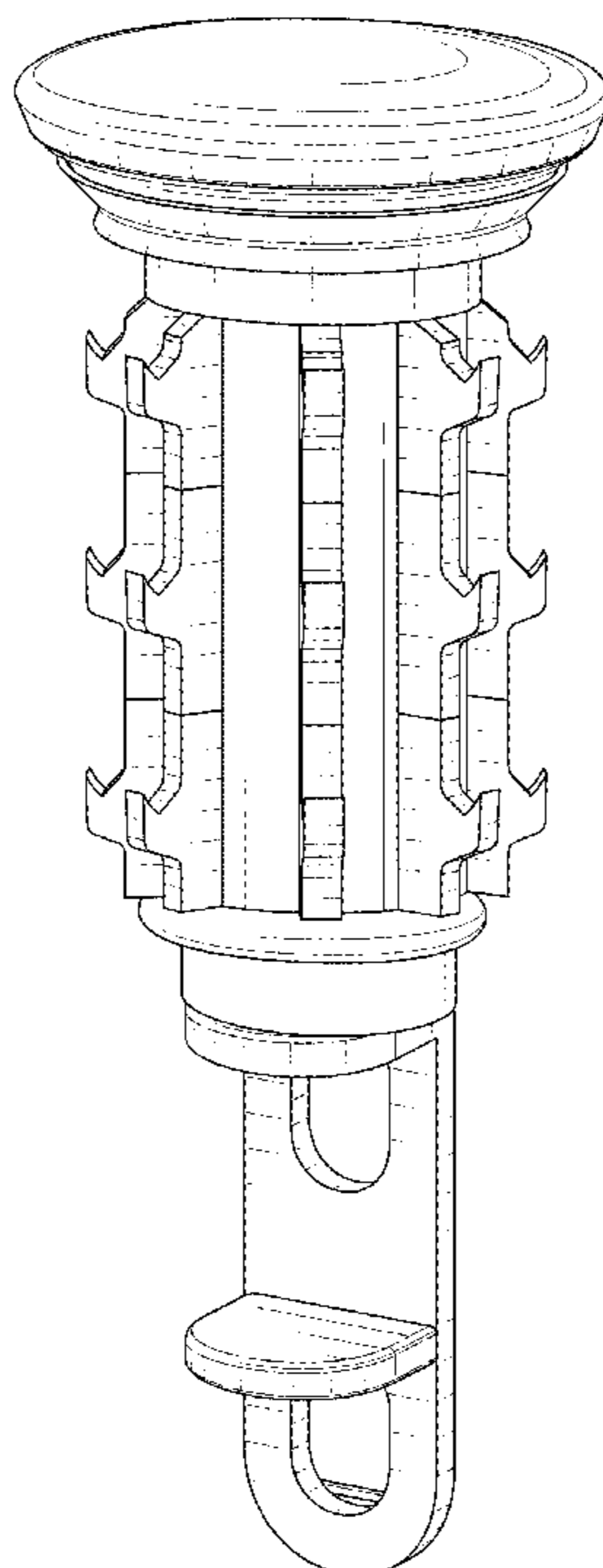

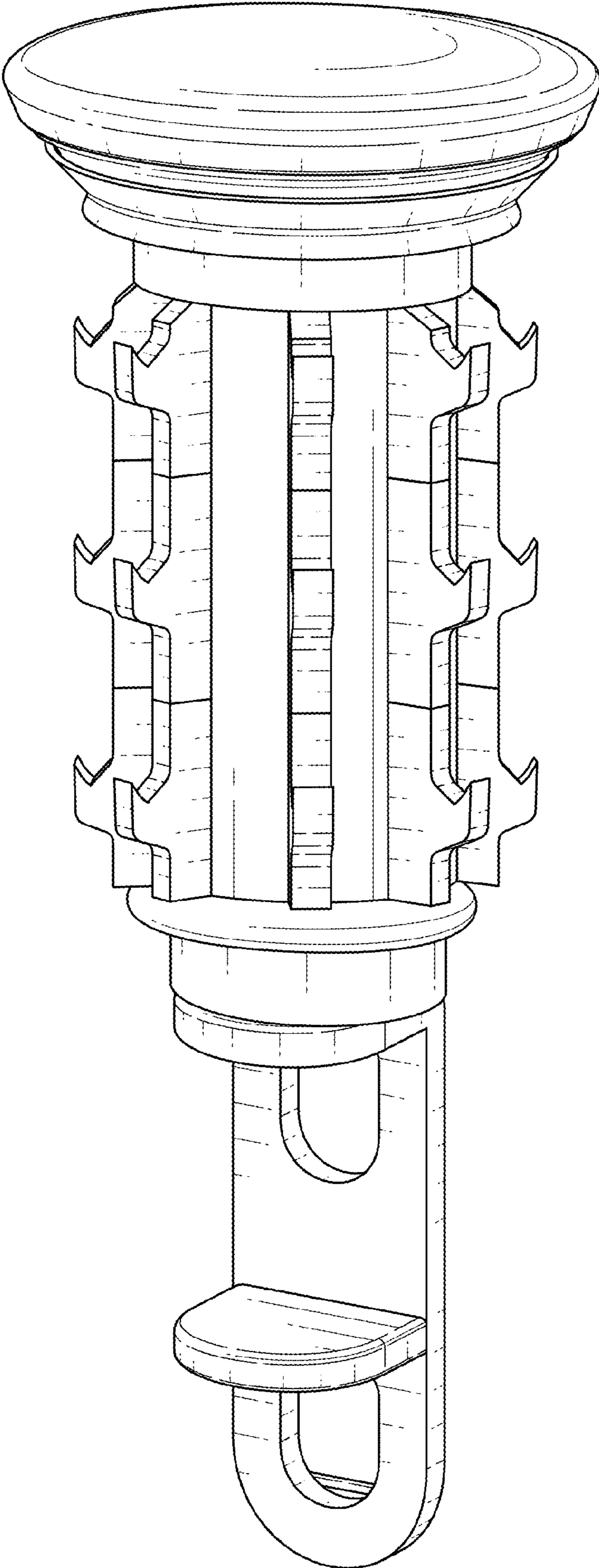

FIG. 1

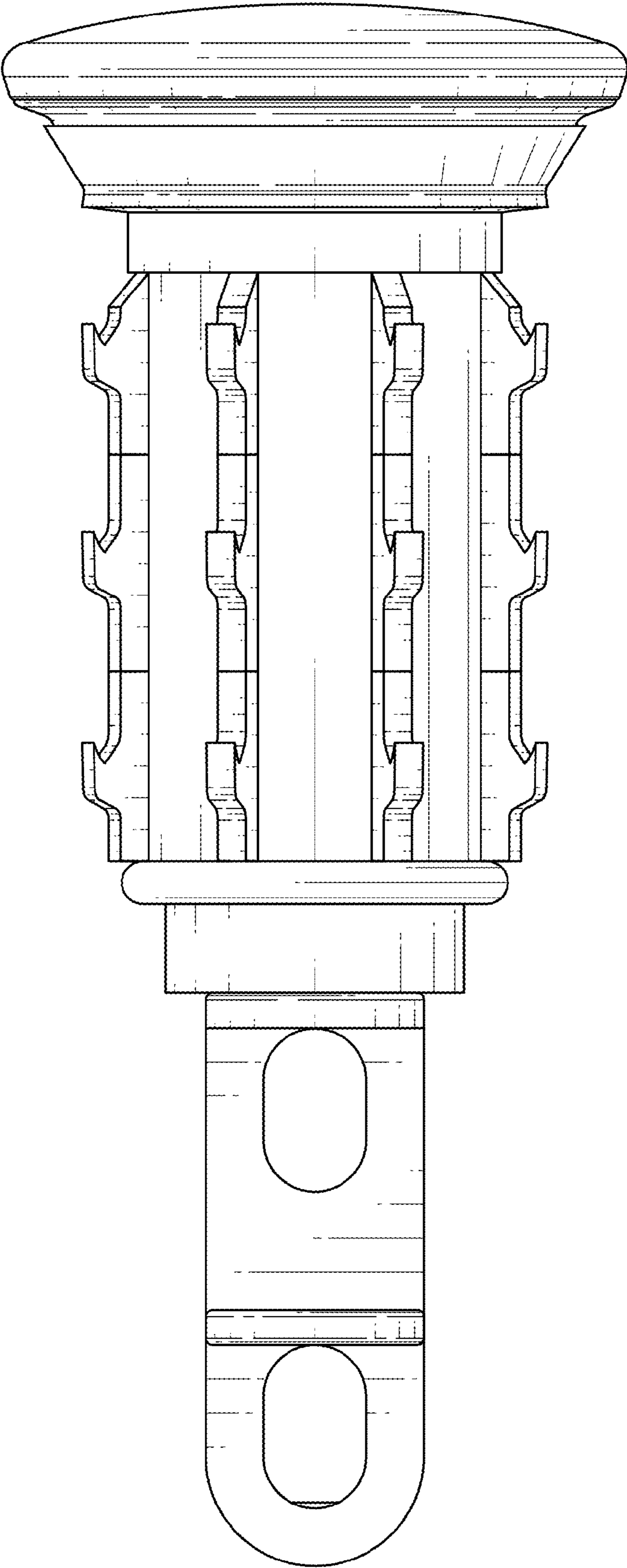

FIG. 2

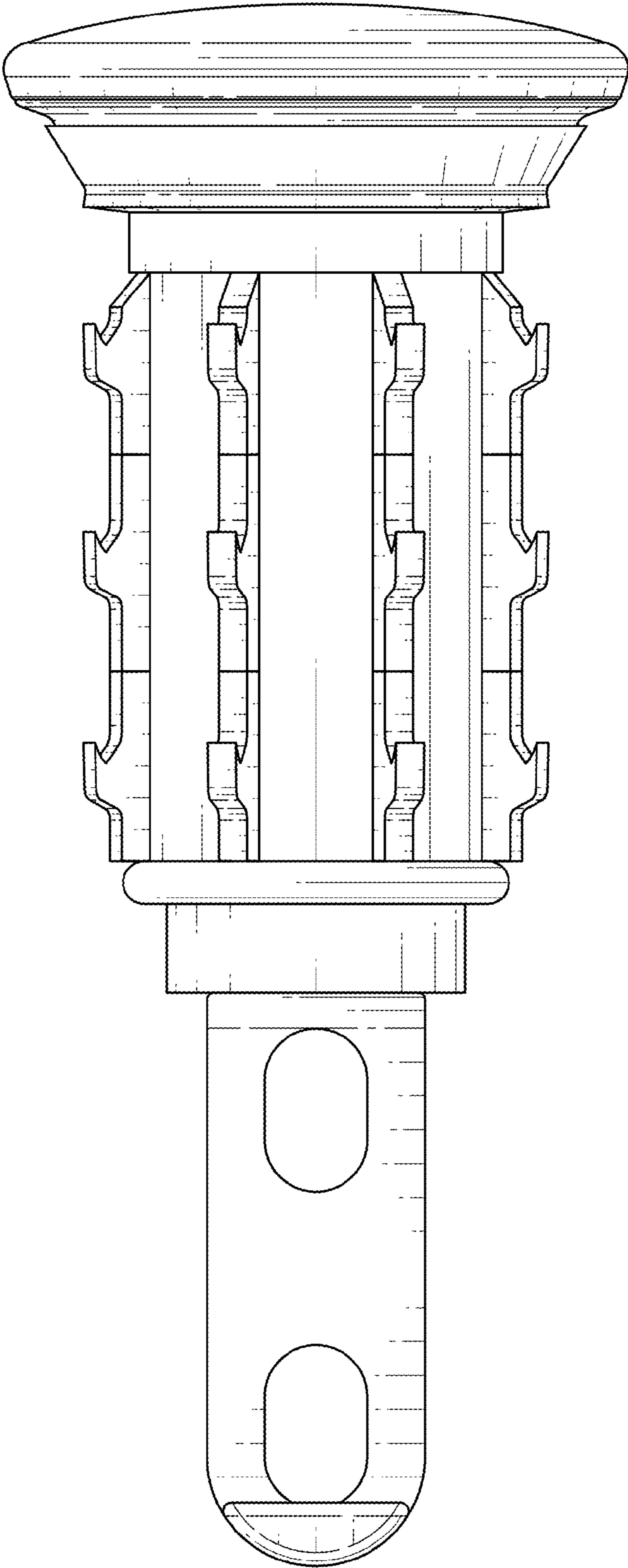

FIG. 3

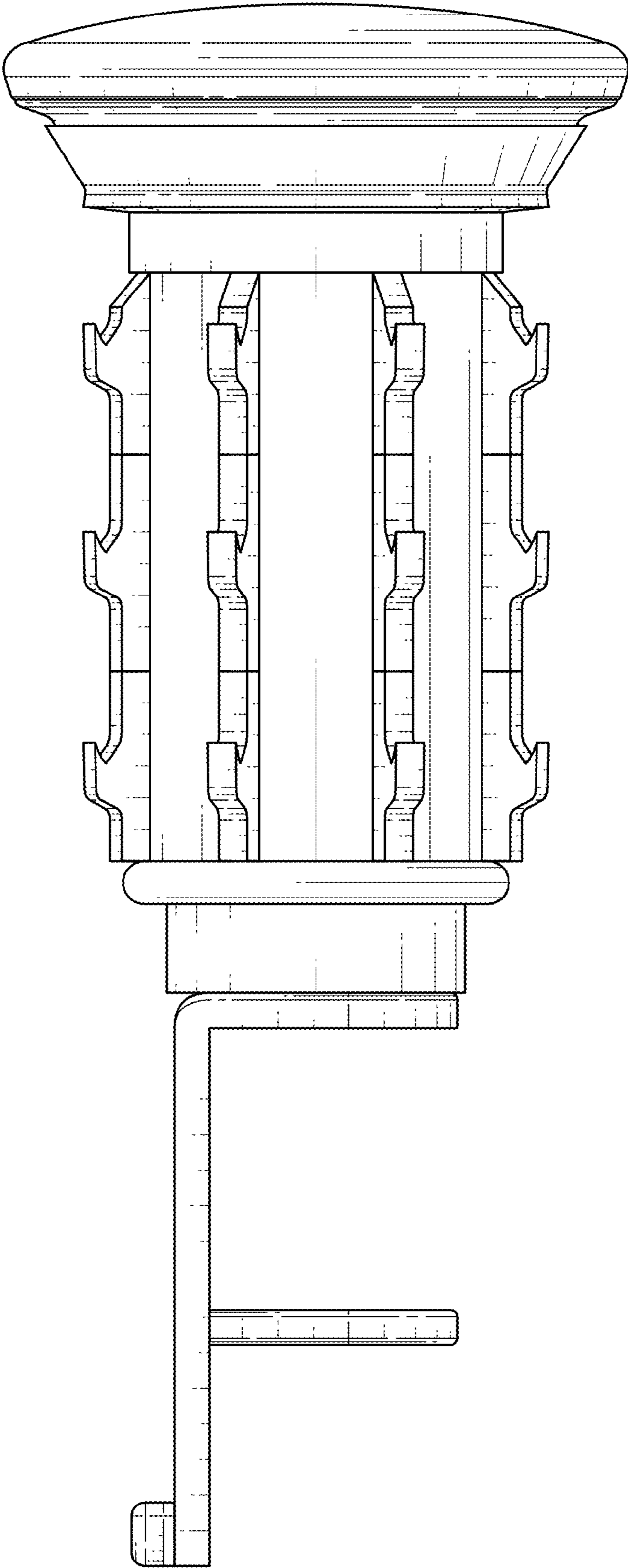

FIG. 4

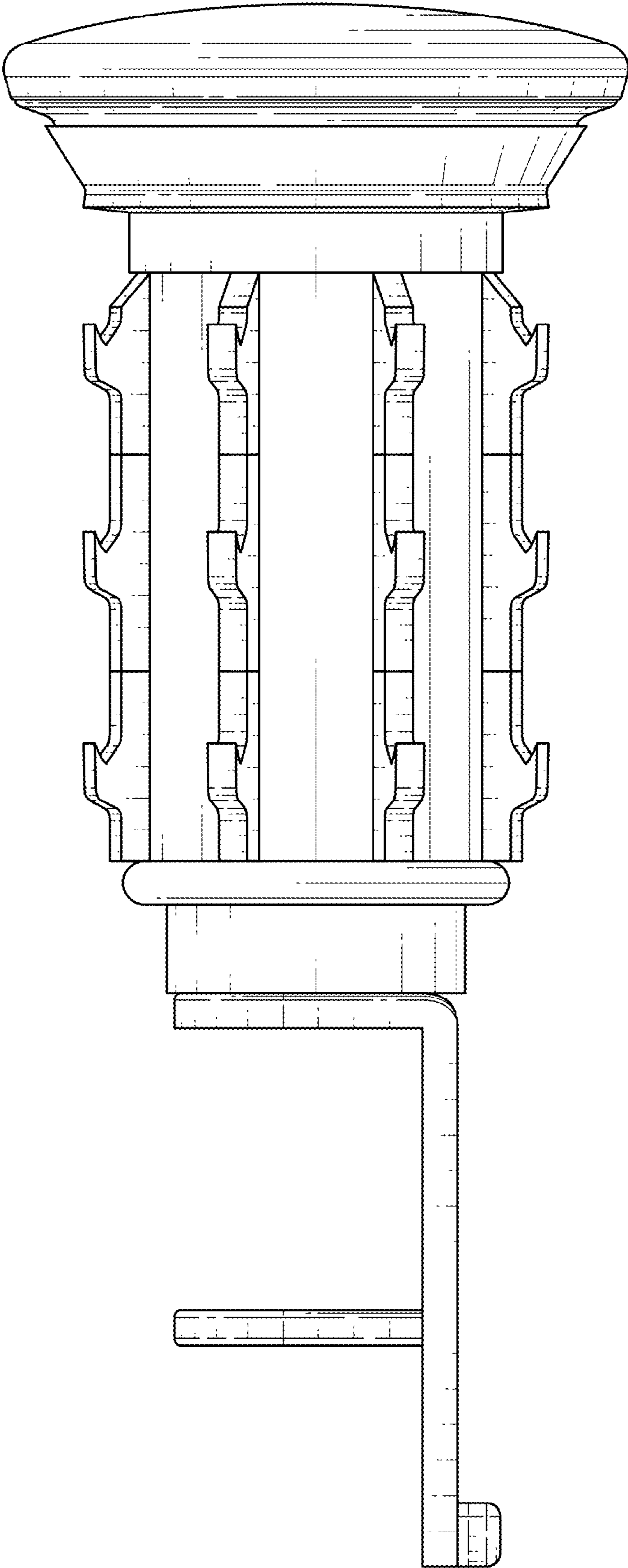

FIG. 5

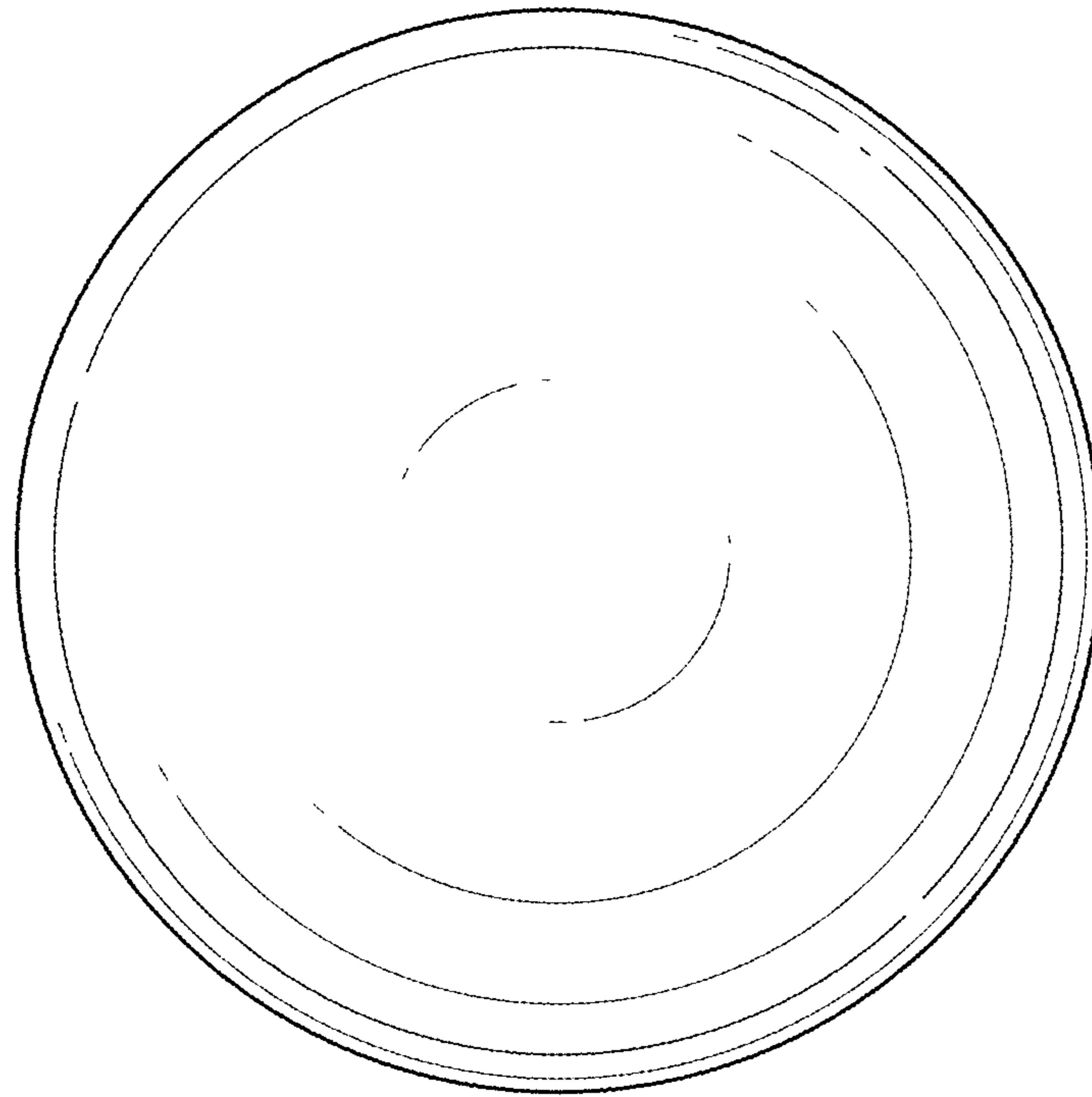

FIG. 6

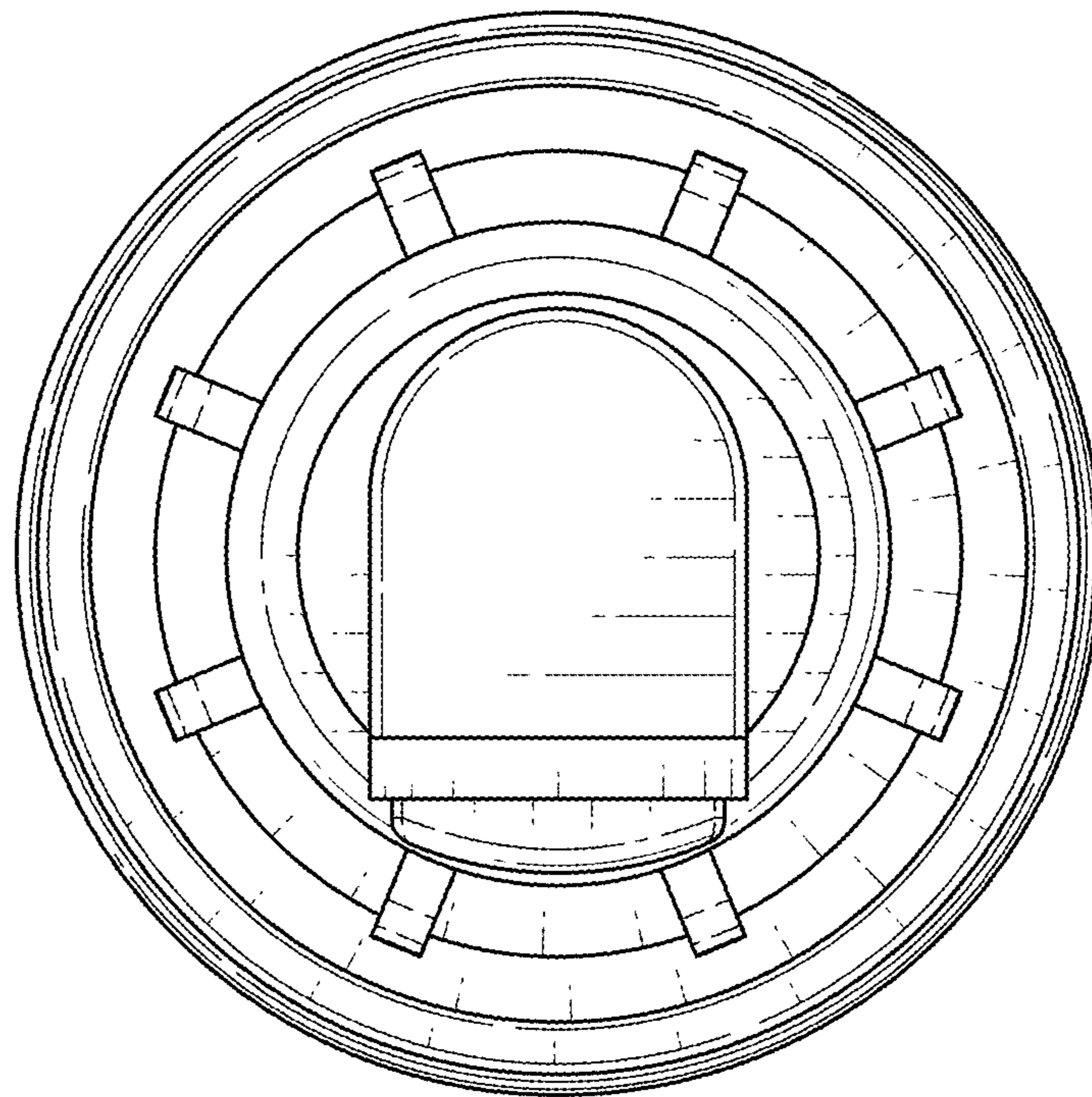

FIG. 7