



US00D900766S

(12) **United States Design Patent** (10) **Patent No.:** **US D900,766 S**
Kim et al. (45) **Date of Patent:** **** Nov. 3, 2020**

(54) **TELEVISION APPARATUS**

(71) Applicant: **LG ELECTRONICS INC.**, Seoul (KR)

(72) Inventors: **Yooseok Kim**, Seoul (KR); **Hyojin Won**, Seoul (KR); **Yongseok Kim**, Seoul (KR); **Sangik Lee**, Seoul (KR)

(73) Assignee: **LG ELECTRONICS INC.**, Seoul (KR)

(**) Term: **15 Years**

(21) Appl. No.: **35/507,653**

(22) Filed: **May 8, 2019**

(80) **Hague Agreement Data**

Int. Filing Date: **May 8, 2019**

Int. Reg. No.: **DM/203568**

Int. Reg. Date: **May 8, 2019**

Int. Reg. Pub. Date: **Nov. 8, 2019**

(30) **Foreign Application Priority Data**

Nov. 13, 2018 (KR) 30-2018-0052338

(51) **LOC (12) Cl.** **14-03**

(52) **U.S. Cl.**
USPC **D14/126**

(58) **Field of Classification Search**

USPC D14/126, 336, 371, 374, 377

CPC .. H04N 19/176; H04N 21/812; H04N 19/159;
H04N 19/105; H04N 19/124; H04N 19/46; H04N 19/52; H04N 19/593; H04N 21/668; H04N 19/117; H04N 19/13; H04N 19/154; H04N 19/513; H04N 19/59; H04N 19/61; H04N 21/235; H04N 21/4126; H04N 21/4307; H04N 21/435; H04N 21/44204; H04N 21/44222; H04N 21/4622; H04N 21/472; H04N 21/4722; H04N 21/4788; H04N 21/8133; H04N 21/858; H04N 19/139; H04N 19/172;

H04N 19/174; H04N 19/184; H04N 19/51; H04N 19/597; H04N 19/70; H04N 19/96; H04N 21/2187; H04N 21/23418; H04N 21/2407; H04N 21/25891; H04N 21/41407; H04N 21/4223; H04N 21/47217; H04N 21/47815; H04N 21/64322; H04N 21/6581; H04N 21/6582; H04N 21/8352; H04N 21/8549; H04N 21/8586; H04N 13/111; H04N 13/117; H04N 13/128; H04N 13/15; H04N 13/296; H04N 13/305; H04N 19/102; H04N 19/109; H04N 19/115; H04N 19/132; H04N 19/136; H04N 19/146; H04N 19/17; H04N 19/177; H04N 19/436; H04N 19/463; H04N (Continued)

(56) **References Cited**

U.S. PATENT DOCUMENTS

D545,778 S * 7/2007 Isshiki D14/126
D562,788 S * 2/2008 Asanuma D14/126
(Continued)

Primary Examiner — Khawaja Anwar

(74) *Attorney, Agent, or Firm* — Birch, Stewart, Kolasch & Birch, LLP

(57) **CLAIM**

The ornamental design for a television apparatus, as shown and described.

DESCRIPTION

- 1. Television apparatus
- 1.1 : Perspective
- 1.2 : Rear perspective view
- 1.3 : Front
- 1.4 : Back
- 1.5 : Left
- 1.6 : Right
- 1.7 : Top
- 1.8 : Bottom

(Continued)

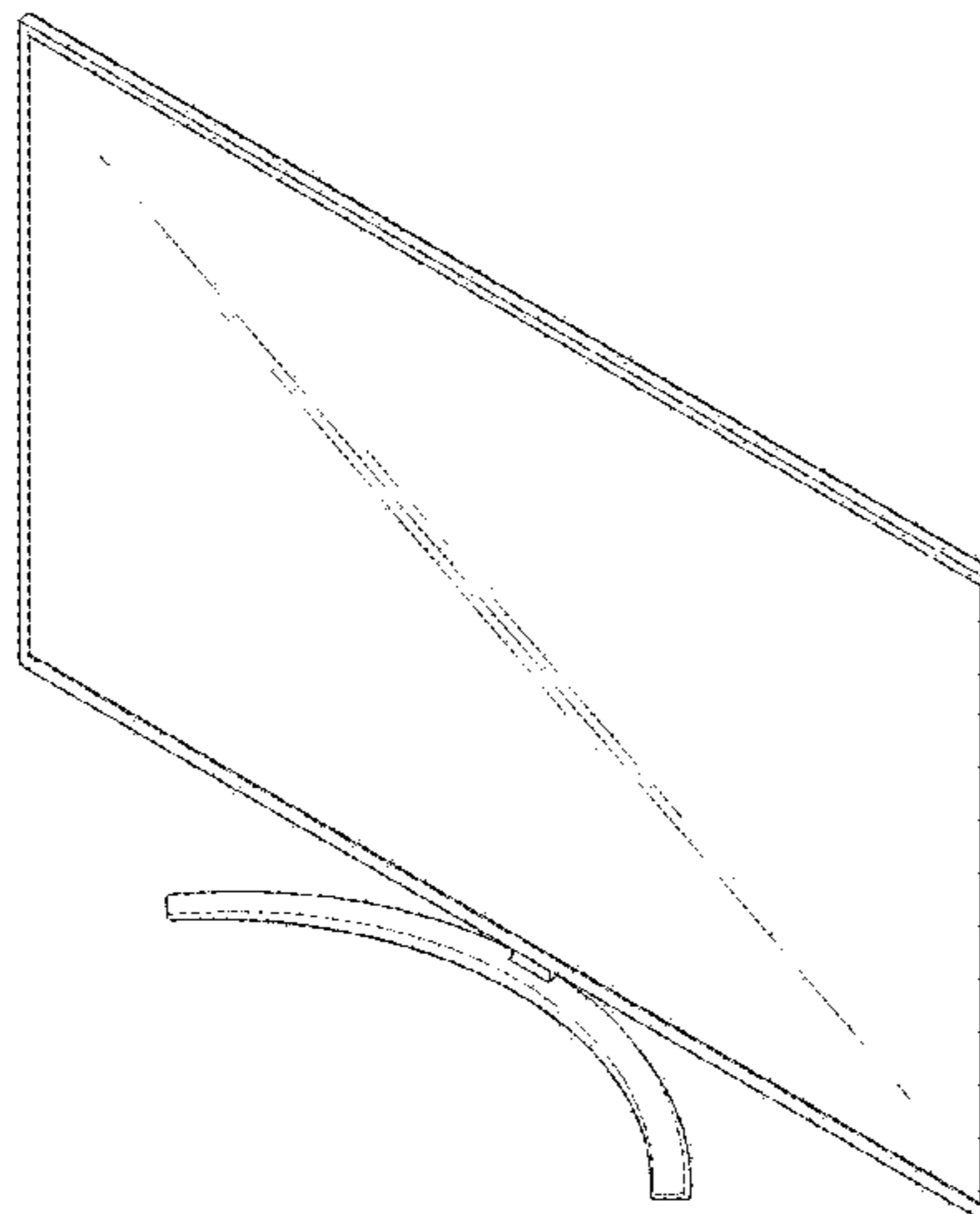

The broken lines indicate portions of the article that form no part of the claimed design.

1 Claim, 8 Drawing Sheets

(58) Field of Classification Search

CPC 19/503; H04N 19/53; H04N 19/563; H04N 19/577; H04N 19/82; H04N 19/91; H04N 21/222; H04N 21/23103; H04N 21/23106; H04N 21/233; H04N 21/2353; H04N 21/236; H04N 21/2362; H04N 21/238; H04N 21/2387; H04N 21/2393; H04N 21/2402; H04N 21/251; H04N 21/26258; H04N 21/2743; H04N 21/2747; H04N 21/4147; H04N 21/4316; H04N 21/4334; H04N 21/437; H04N 21/4383; H04N 21/44016; H04N 21/442; H04N 21/44213; H04N 21/4532; H04N 21/462; H04N 21/47202; H04N 21/4725; H04N 21/4781; H04N 21/4782; H04N 21/647; H04N 21/64738; H04N 21/6587; H04N 21/8358; H04N 21/8456; H04N 5/23238; H04N 5/247; H04N 5/76; H04N 7/17336; H04N 13/139; H04N 13/144; H04N 13/161; H04N 13/194; H04N 13/221; H04N 13/229; H04N 13/239; H04N 13/246; H04N 13/261; H04N 23/271; H04N 13/282; H04N 13/317; H04N 13/324; H04N 13/337; H04N 13/341; H04N 13/344; H04N 13/366; H04N 13/376; H04N 13/378; H04N 17/002; H04N 19/00; H04N 19/107; H04N 19/122; H04N 19/129; H04N 19/134; H04N 19/14; H04N 19/157; H04N 19/167; H04N 19/179; H04N 19/186; H04N 19/1883; H04N 19/189; H04N 19/192; H04N 19/197; H04N 19/30; H04N 19/33; H04N 19/433; H04N 19/439; H04N 19/44; H04N 19/50; H04N 19/517; H04N 19/573; H04N 19/60; H04N 19/615; H04N 19/63; H04N 19/68; H04N 19/86; H04N 19/90; H04N 19/93; H04N 2005/441; H04N 2013/0081; H04N 21/20; H04N 21/246; H04N 21/21805; H04N 21/2181; H04N 21/23113; H04N 21/23116; H04N 23/23406; H04N 21/23412; H04N 21/23424; H04N 21/23439; H04N 21/2347; H04N 21/23611; H04N 21/2368; H04N 21/237; H04N 21/2383; H04N 21/23892; H04N 21/2408; H04N 21/242; H04N 21/252; H04N 21/2542; H04N 21/2543; H04N 21/258; H04N 21/25875; H04N

21/25883; H04N 21/262; H04N 21/26216; H04N 21/26291; H04N 21/266; H04N 21/26603; H04N 21/27; H04N 21/278; H04N 21/4131; H04N 21/41422; H04N 21/422; H04N 21/42203; H04N 21/42204; H04N 21/42209; H04N 21/4222; H04N 21/42222; H04N 21/42224; H04N 21/4227; H04N 21/4302; H04N 21/431; H04N 21/4312; H04N 21/4314; H04N 21/433; H04N 21/4333; H04N 21/4335; H04N 21/4345; H04N 21/436; H04N 21/43615; H04N 21/439; H04N 21/44; H04N 21/44004; H04N 21/44008; H04N 21/4415; H04N 21/44209; H04N 21/44218; H04N 21/44231; H04N 21/4424; H04N 21/443; H04N 21/4431; H04N 21/4524; H04N 21/4621; H04N 21/4661; H04N 21/4667; H04N 21/475; H04N 21/4755; H04N 21/4758; H04N 21/478; H04N 21/4784; H04N 21/4821; H04N 21/4825; H04N 21/61; H04N 21/6106; H04N 21/6118; H04N 21/6125; H04N 21/6131; H04N 21/6143; H04N 21/6168; H04N 21/6193; H04N 21/637; H04N 21/643; H04N 21/6437; H04N 21/64707; H04N 21/64723; H04N 21/8113; H04N 21/8146; H04N 21/816; H04N 21/8173; H04N 21/84; H04N 21/8543; H04N 21/8545; H04N 2213/008; H04N 5/23219; H04N 5/23293; H04N 5/2624; H04N 5/2628; H04N 5/265; H04N 5/44504; H04N 5/44543; H04N 5/44591; H04N 5/9202; H04N 7/08; H04N 7/147; H04N 7/148; H04N 7/152; H04N 7/173; H04N 7/186

See application file for complete search history.

(56)

References Cited

U.S. PATENT DOCUMENTS

Table with 4 columns: Patent Number, Kind Code, Date, Inventor Name, and Classification Code. Includes entries for Ooshima, Kita, Lin, Kim, Lim, Lee, Cha, and Kim with various dates and classification codes.

* cited by examiner

1.1

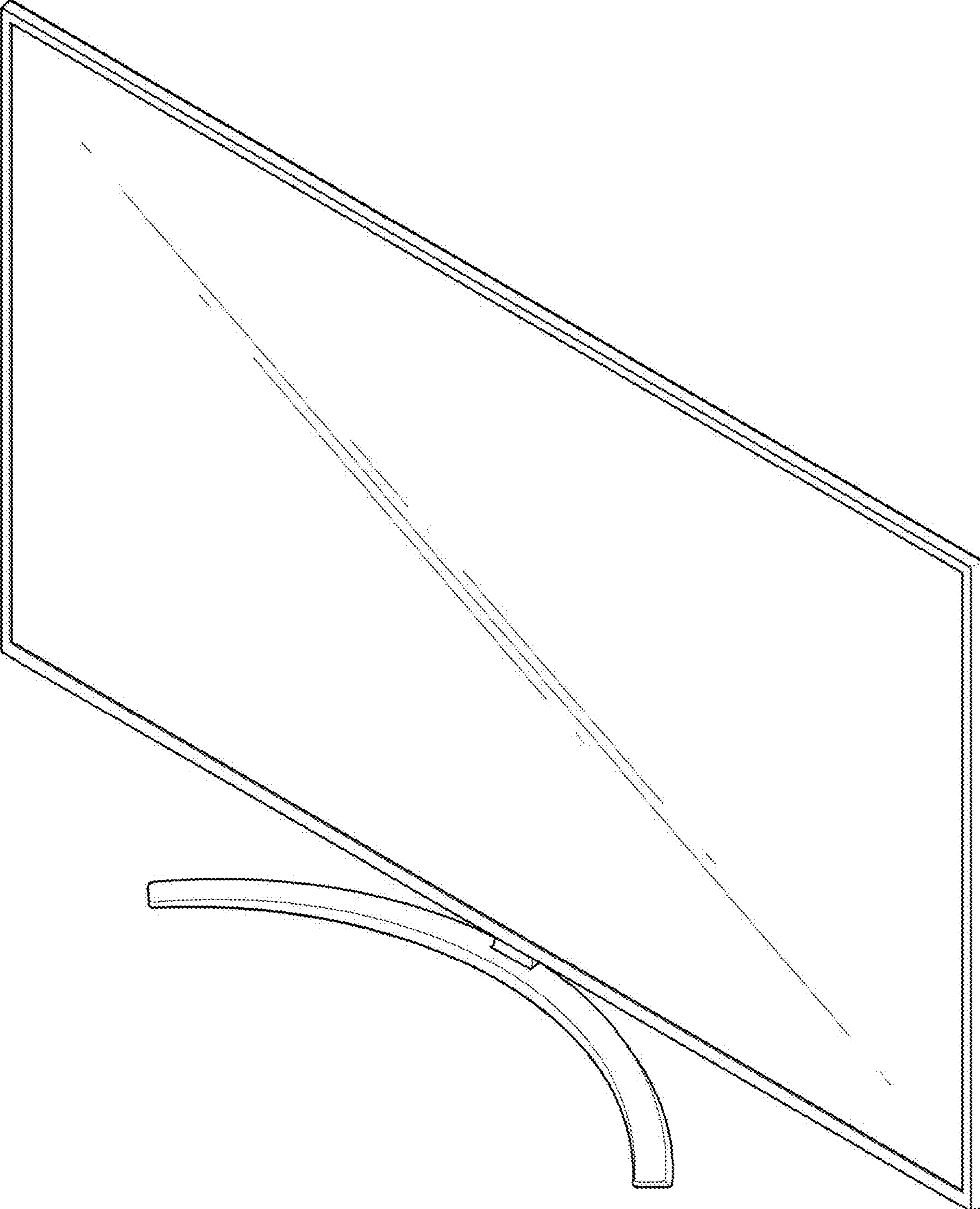

1.2

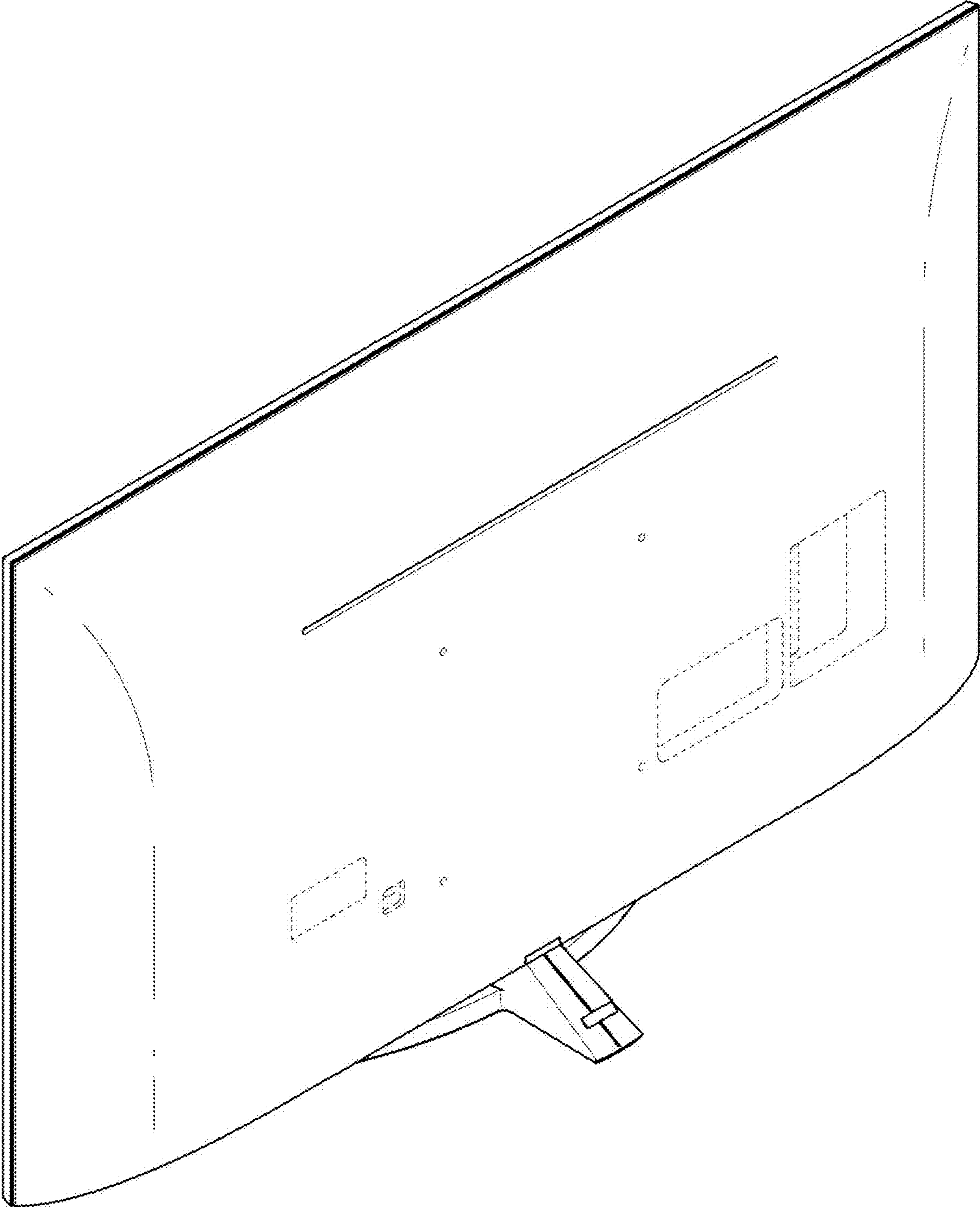

1.3

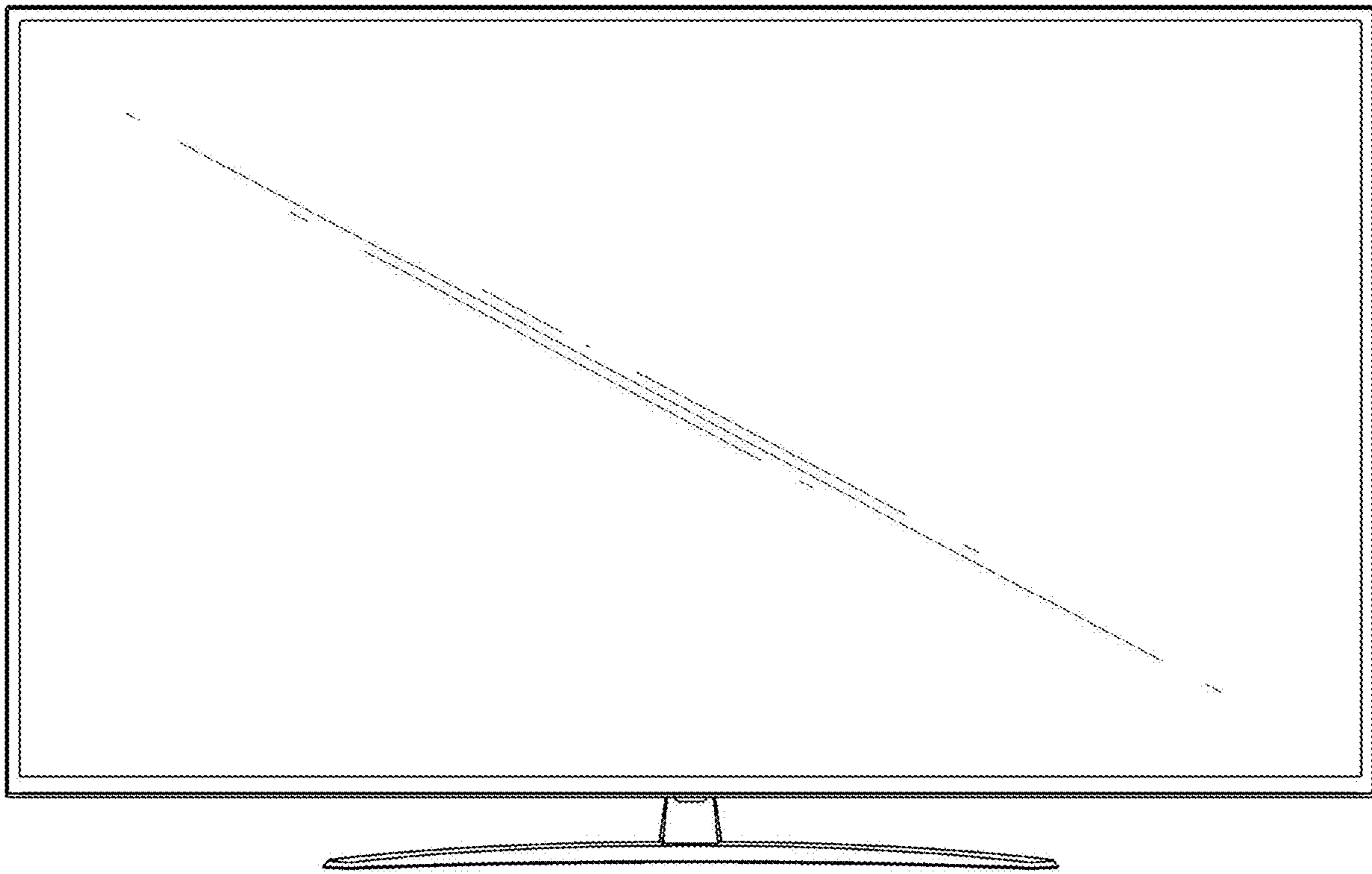

1.4

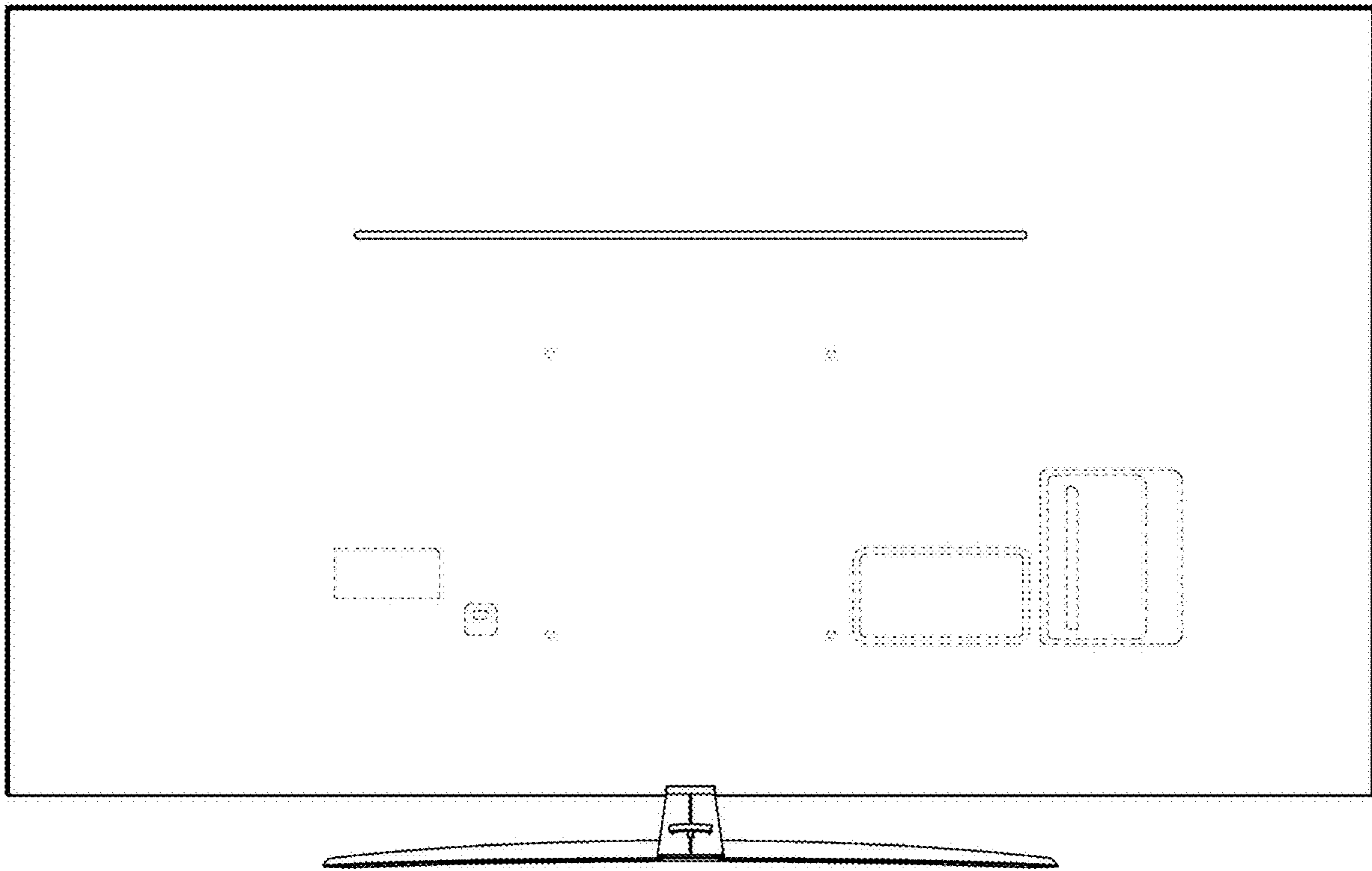

1.5

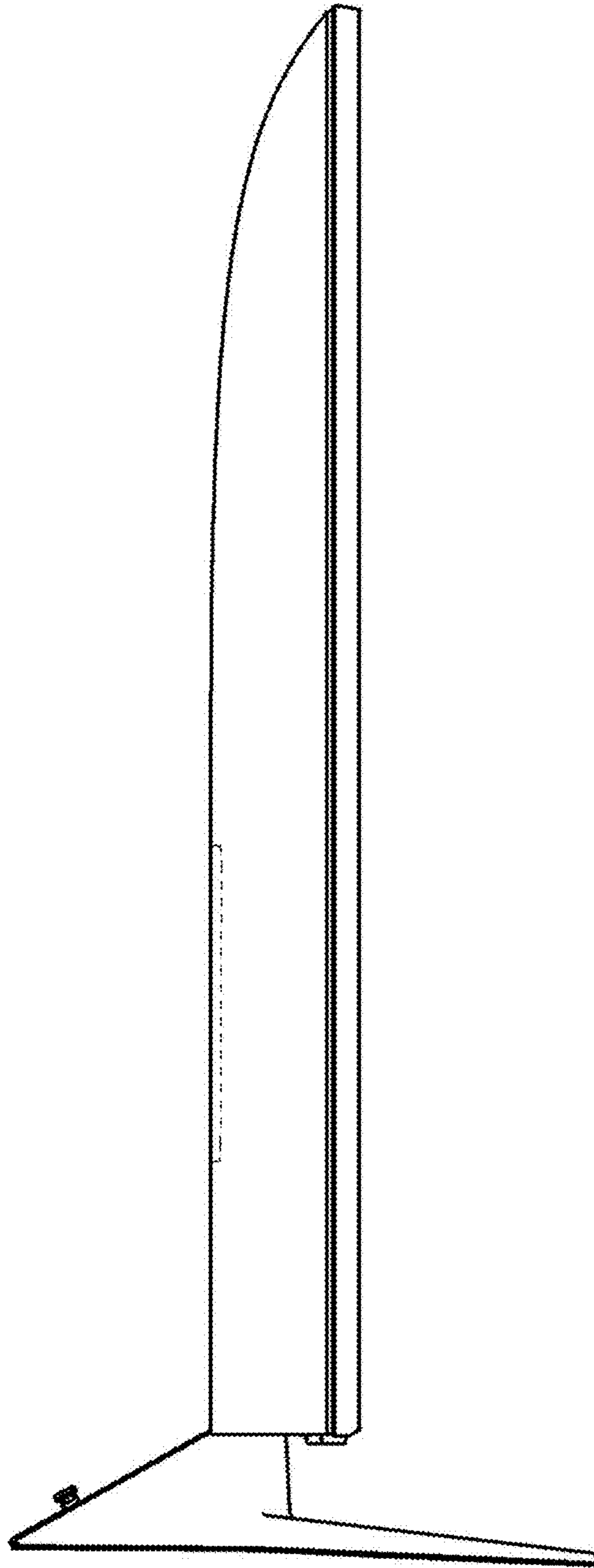

1.6

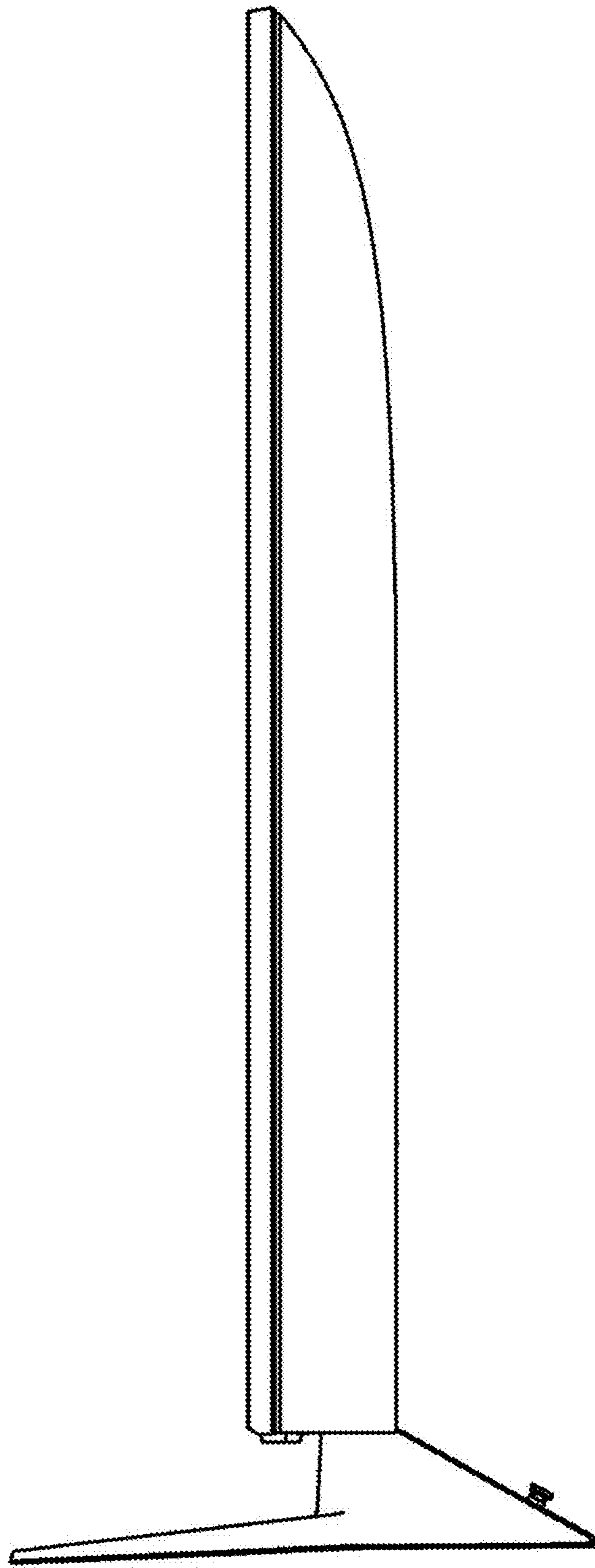

1.7

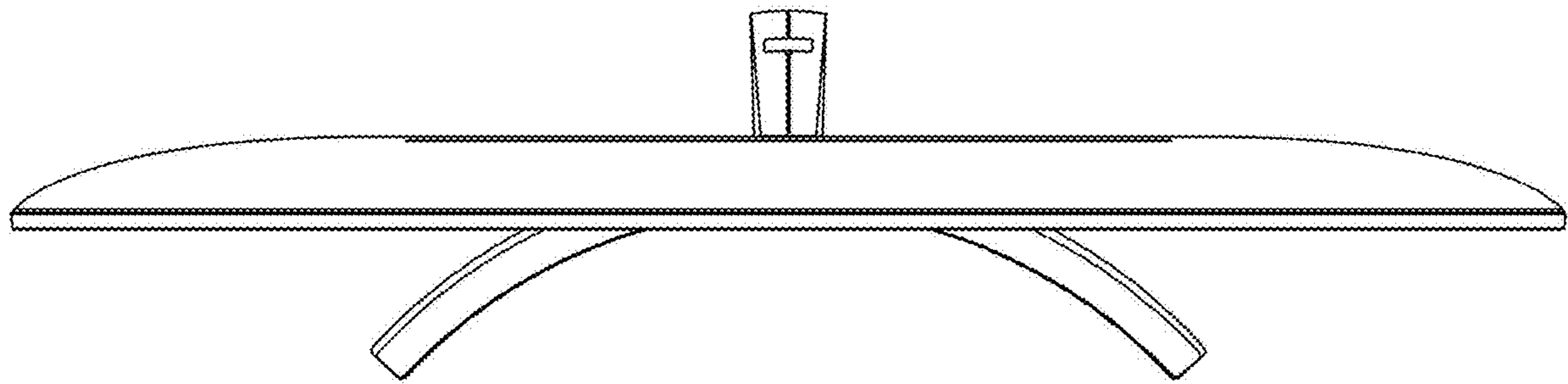

1.8

