



US00D900739S

(12) **United States Design Patent**
Wei et al.

(10) **Patent No.:** **US D900,739 S**

(45) **Date of Patent:** **** Nov. 3, 2020**

(54) **CHARGER**

(71) Applicant: **Aukey Technology Co., Ltd**, Shenzhen (CN)

(72) Inventors: **Xinlong Wei**, Shenzhen (CN);
Haizhuan Lu, Shenzhen (CN)

(73) Assignee: **Aukey Technology Co., Ltd**, Shenzhen (CN)

(**) Term: **15 Years**

(21) Appl. No.: **29/705,462**

(22) Filed: **Sep. 12, 2019**

(51) **LOC (12) Cl.** **13-02**

(52) **U.S. Cl.**
USPC **D13/108**

(58) **Field of Classification Search**
USPC D13/103, 107-108, 110, 184, 199;
D14/251, 253, 432, 434

CPC H02J 7/0044; H02J 7/0045; H02J 7/0042;
H02J 7/342; H02J 7/345; H02J 7/025;
H02J 7/026; H02J 7/0007; H02J 7/0027;
H02J 7/0003; H02J 50/00; H02J 50/10;
H02J 50/12; H02J 50/80; H02J 50/40
See application file for complete search history.

(56) **References Cited**

U.S. PATENT DOCUMENTS

D595,224 S *	6/2009	Seil	D13/108
D657,743 S *	4/2012	Andre	D13/110
D663,687 S *	7/2012	Liu	D13/108
D682,781 S *	5/2013	Wakafuji	D13/110
D694,183 S *	11/2013	Matsuoka	D13/110
D694,185 S *	11/2013	Matsuoka	D13/110
D711,824 S *	8/2014	Matsuoka	D13/110

D731,970 S *	6/2015	Kamath	D13/110
D734,259 S *	7/2015	Cepress	D13/110
D741,796 S *	10/2015	Robinson	D13/108
D742,315 S *	11/2015	Dang	D13/110
D756,916 S *	5/2016	Yang	D13/108
D772,160 S *	11/2016	Roberts	D13/110
D790,464 S *	6/2017	He	D13/110
D796,432 S *	9/2017	Liu	D13/107
D819,566 S *	6/2018	Hung	D13/110
D850,366 S *	6/2019	Zou	D13/108
D867,287 S *	11/2019	Akana	D13/110
D879,710 S *	3/2020	Yang	D13/108
D879,712 S *	3/2020	Fan	D13/108
D892,735 S *	8/2020	Zhang	D13/108

* cited by examiner

Primary Examiner — Rosemary K Tarcza

(74) *Attorney, Agent, or Firm* — Westbridge IP LLC

(57) **CLAIM**

The ornamental design for a charger, as shown and described.

DESCRIPTION

FIG. 1 is a front elevational view of a charger showing our new design;
FIG. 2 is a rear elevational view thereof;
FIG. 3 is a left side view thereof;
FIG. 4 is a right side view thereof;
FIG. 5 is a top plan view thereof;
FIG. 6 is a bottom plan view thereof;
FIG. 7 is a front, left perspective view thereof;
FIG. 8 is a rear, right perspective view thereof; and,
FIG. 9 is a rear, right perspective view thereof in a use state.
The broken lines in the drawings are for purposes of illustrating portions of the charger that form no part of the claimed design.

1 Claim, 9 Drawing Sheets

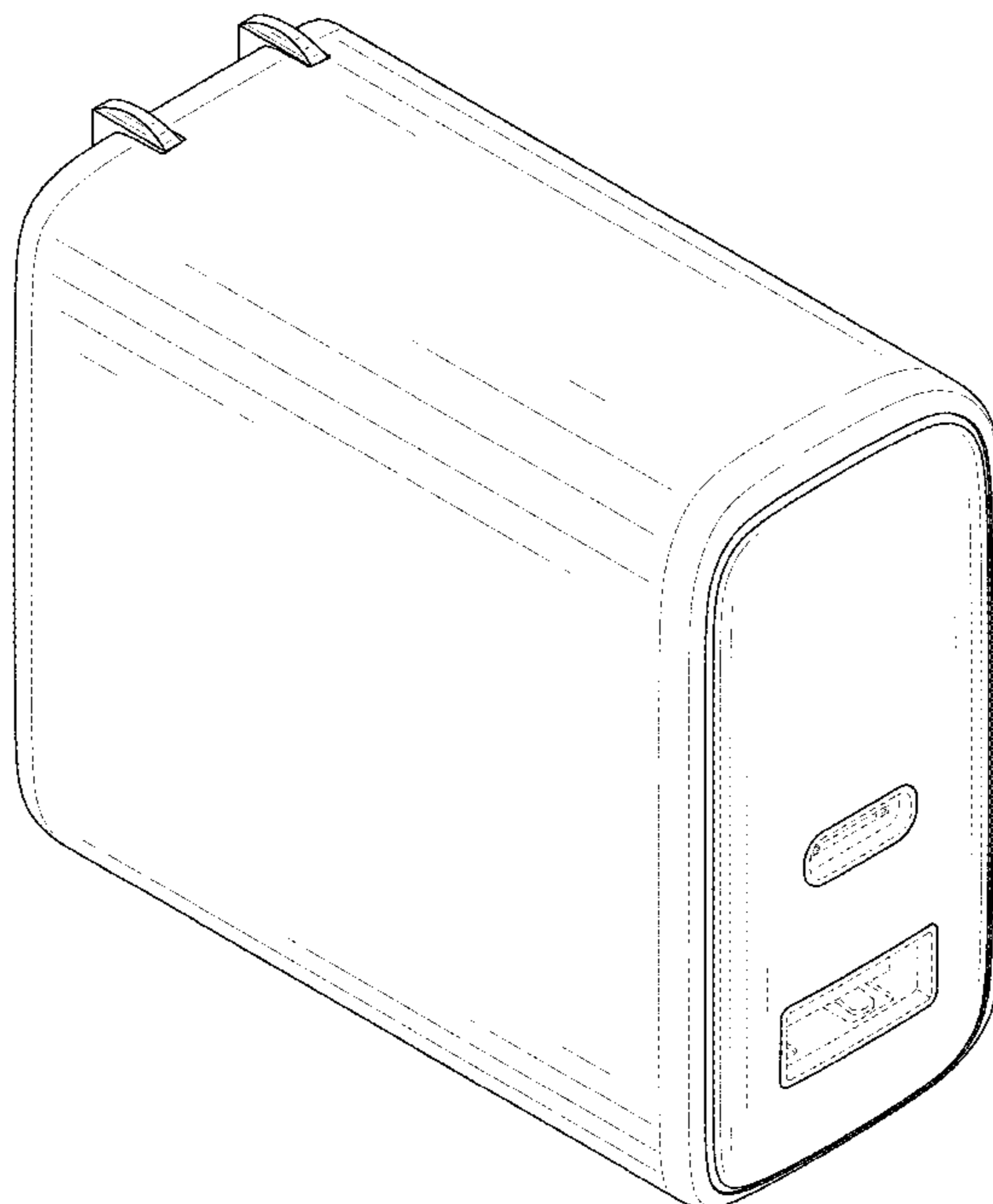

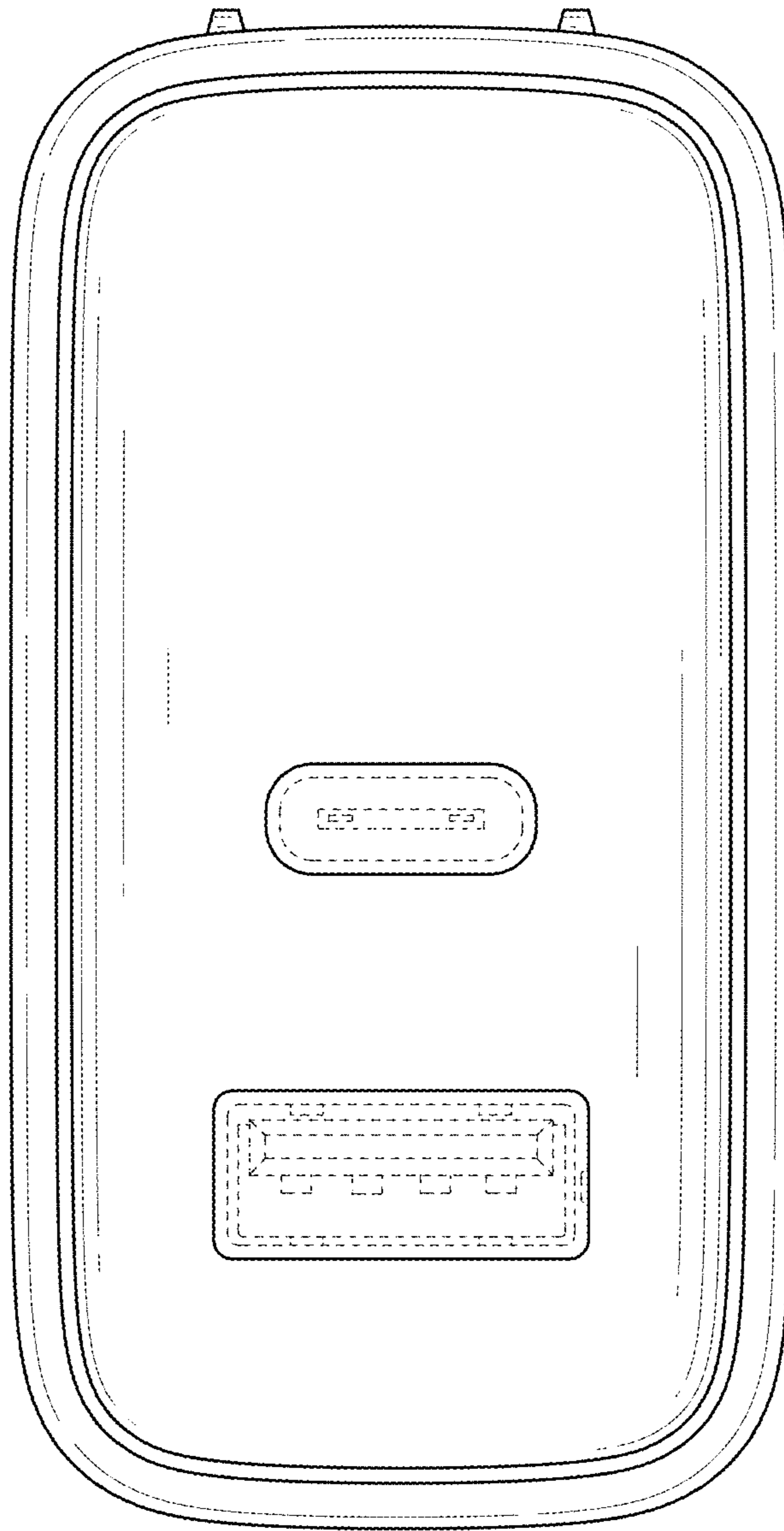

FIG. 1

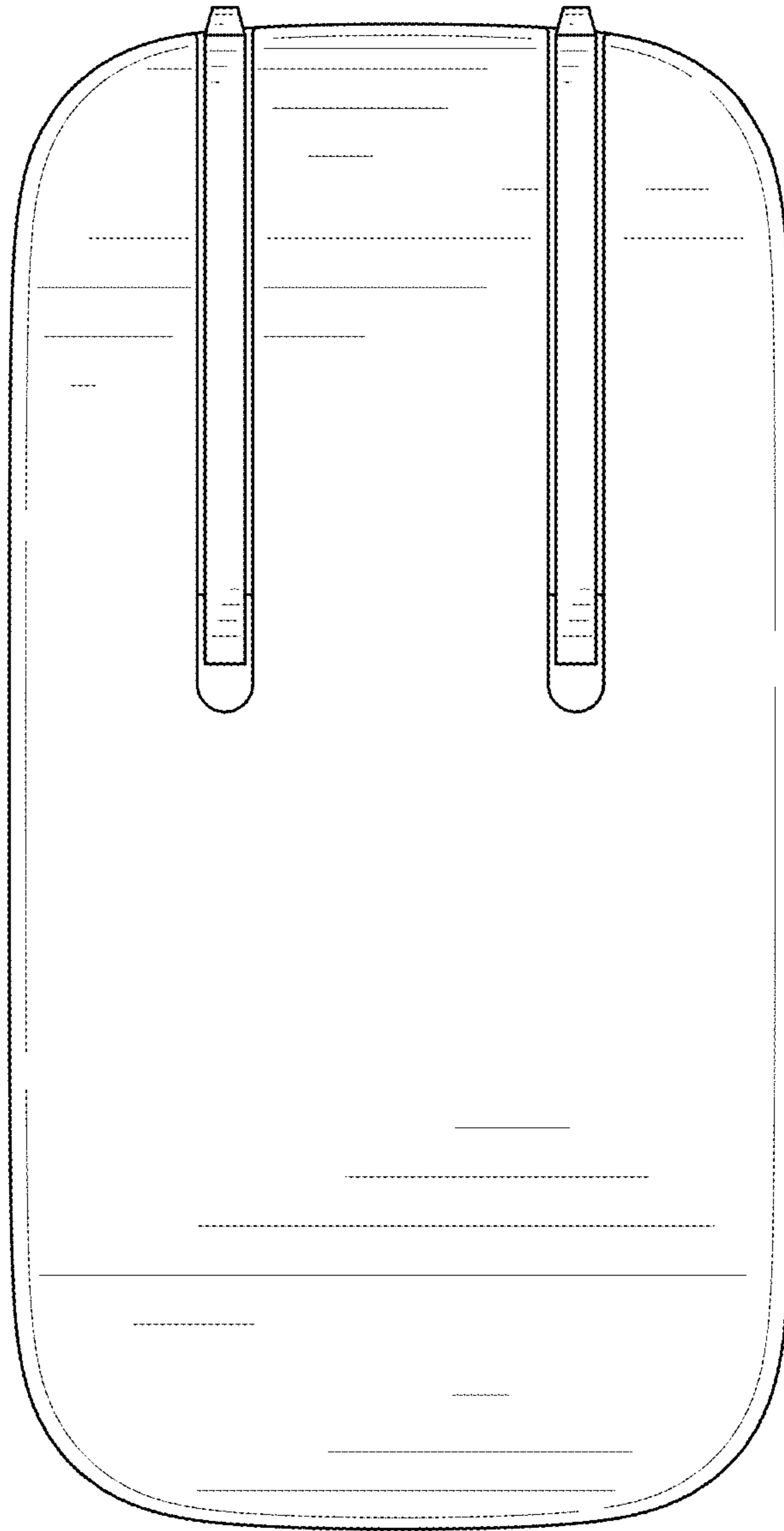

FIG. 2



FIG. 3

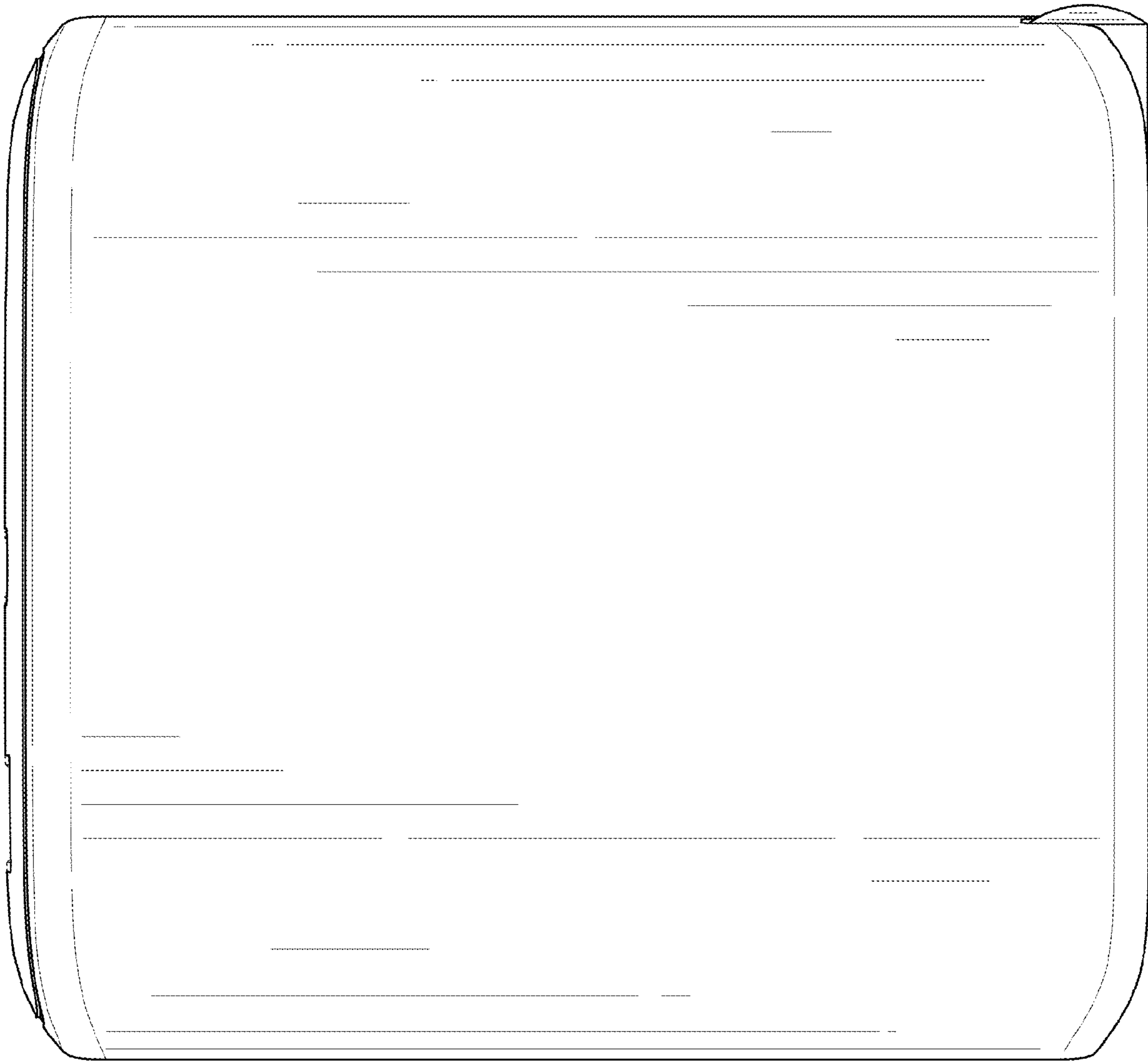

FIG. 4

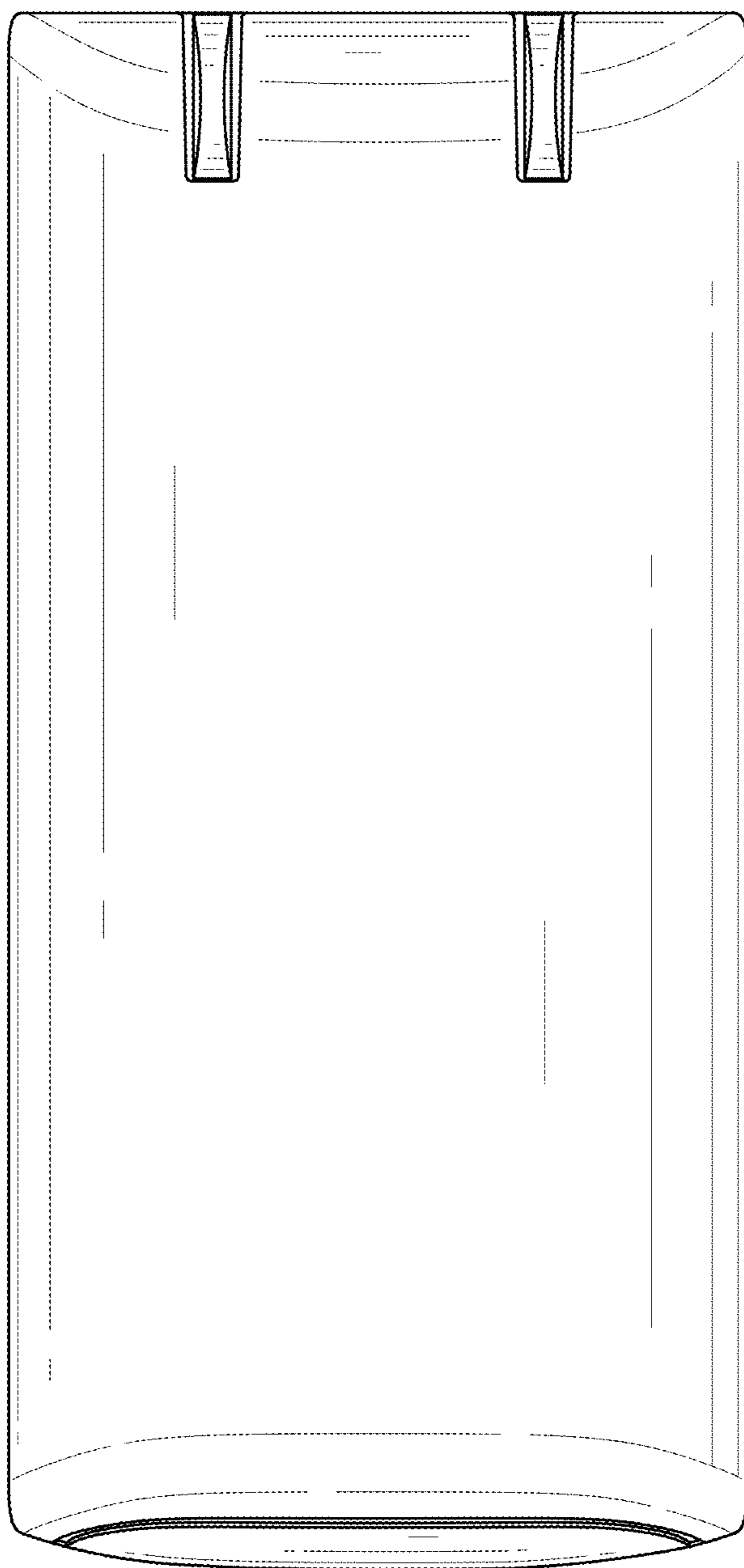

FIG. 5

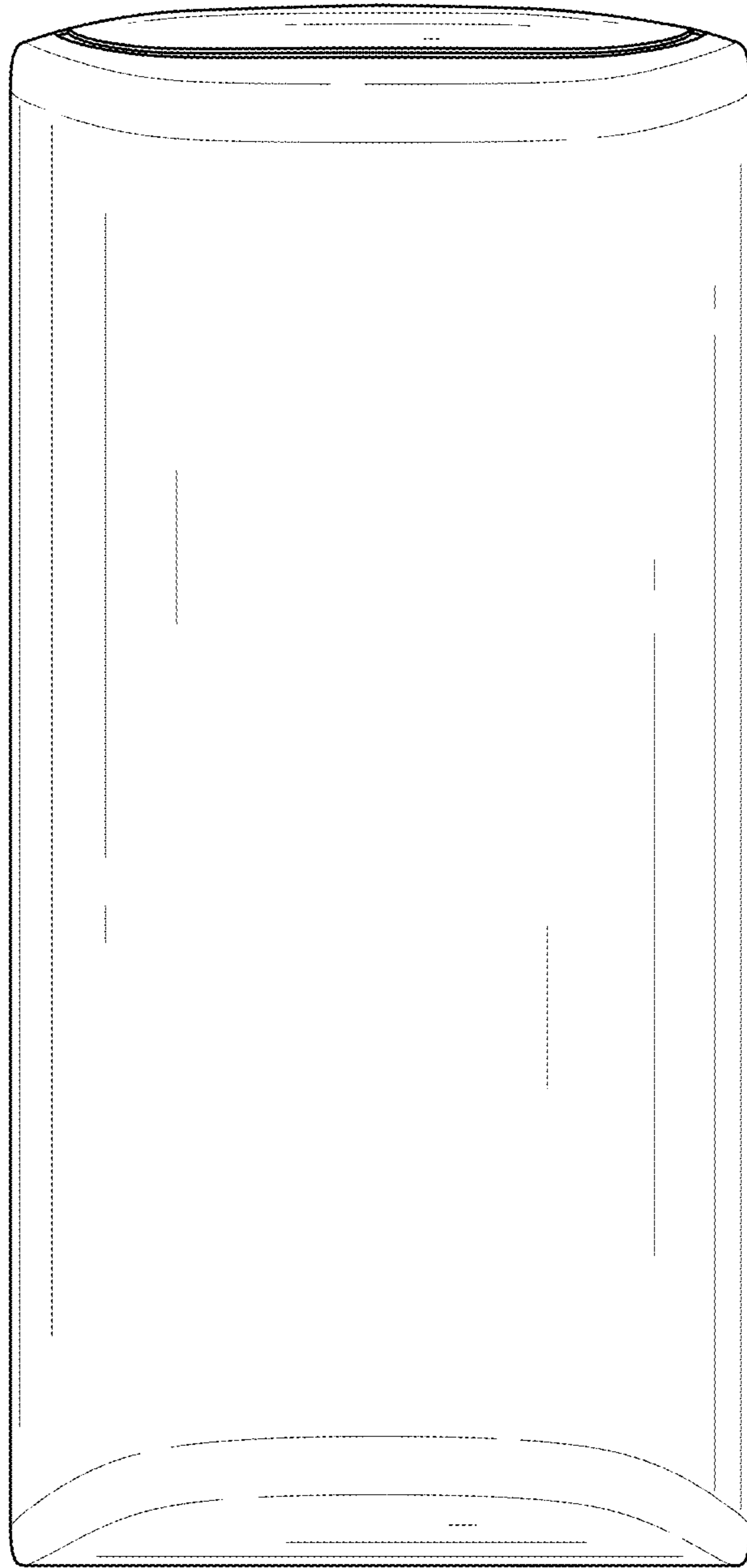

FIG. 6

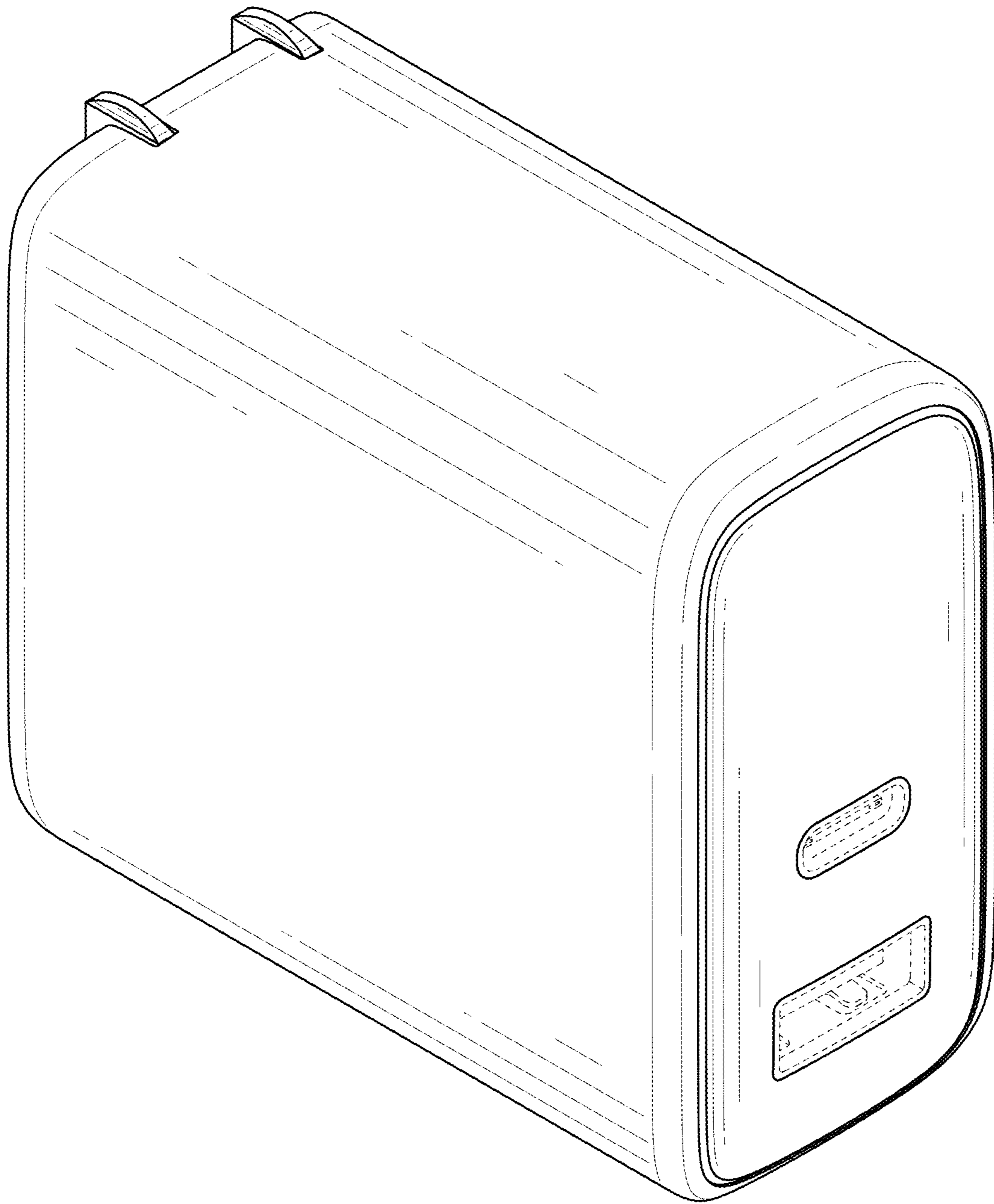

FIG. 7

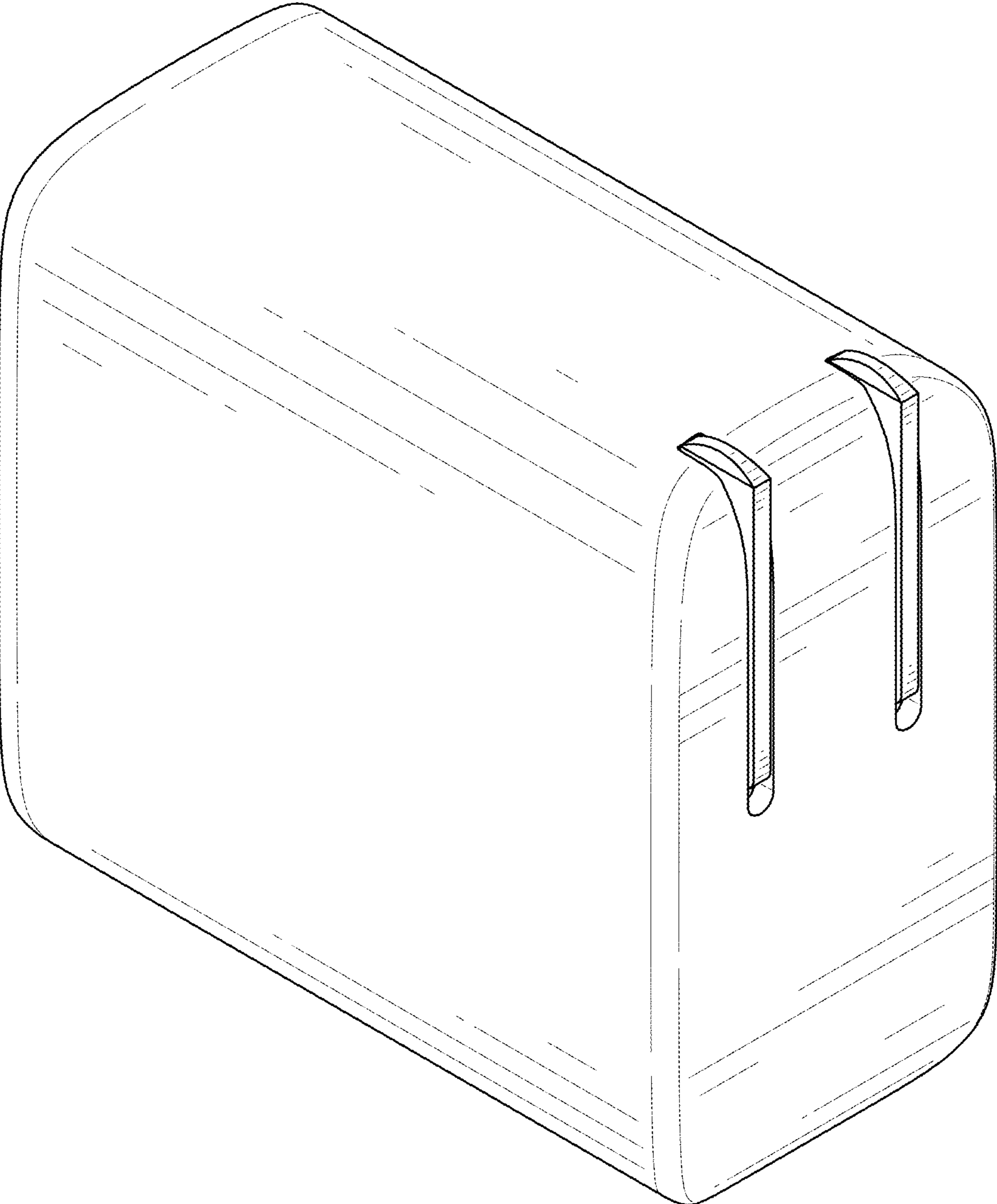

FIG. 8

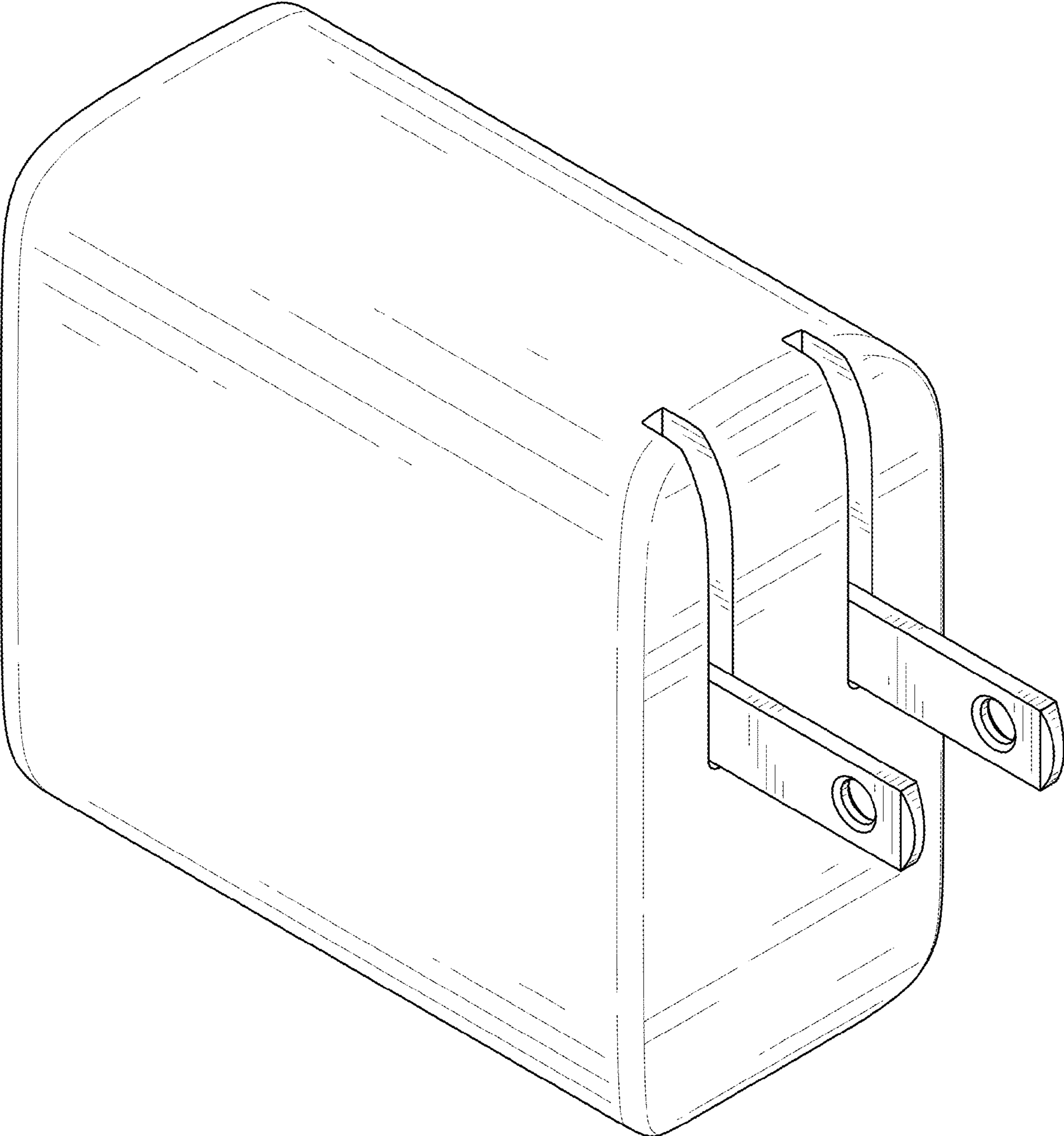

FIG. 9