



US00D900732S

(12) **United States Design Patent** (10) **Patent No.:** **US D900,732 S**
Sexton et al. (45) **Date of Patent:** **** Nov. 3, 2020**

(54) **CHARGER**

(71) Applicant: **Techtronic Cordless GP**, Anderson, SC (US)

(72) Inventors: **Joseph Sexton**, Charlotte, NC (US);
Shuang Lin, Charlotte, NC (US)

(73) Assignee: **Techtronic Cordless GP**, Anderson, SC (US)

(**) Term: **15 Years**

(21) Appl. No.: **29/696,041**

(22) Filed: **Jun. 25, 2019**

(51) **LOC (12) Cl.** **13-02**

(52) **U.S. Cl.**
USPC **D13/107**

(58) **Field of Classification Search**
USPC D13/103, 107-108, 110, 184, 199;
D14/251, 253, 432, 434
CPC H02J 7/0044; H02J 7/0045; H02J 7/0042;
H02J 7/342; H02J 7/345; H02J 7/025;
H02J 7/026; H02J 7/0007; H02J 7/0027;
H02J 7/0003; H02J 50/00; H02J 50/10;
H02J 50/12; H02J 50/80; H02J 50/40;
H02J 50/402; H02J 50/50
See application file for complete search history.

(56) **References Cited**

U.S. PATENT DOCUMENTS

D327,247 S * 6/1992 Higuchi D13/108
D328,450 S * 8/1992 Watanabe D13/108
D336,631 S * 6/1993 Ivester D13/108
D349,097 S * 7/1994 Watanabe D13/108

D408,352 S * 4/1999 Tashiro D13/107
D462,657 S * 9/2002 Kaneko D13/107
D506,972 S * 7/2005 Parel D13/107
D507,234 S * 7/2005 Heun D13/107
D551,163 S * 9/2007 Hamasaki D13/107
D562,230 S * 2/2008 Houghton D13/107
D601,953 S * 10/2009 Asai D13/107
D609,637 S * 2/2010 Chu D13/108
D721,648 S * 1/2015 Breines D13/107
D723,458 S * 3/2015 Martinez D13/108
D811,997 S * 3/2018 Sha D13/107
D813,806 S * 3/2018 Ito D13/108
D833,389 S * 11/2018 Dunham D13/108
D883,202 S * 5/2020 Edwards D13/108

* cited by examiner

Primary Examiner — Rosemary K Tarcza

(74) *Attorney, Agent, or Firm* — Michael Best & Friedrich LLP

(57) **CLAIM**

We claim the ornamental design for a charger, as shown.

DESCRIPTION

FIG. 1 is a perspective view of a charger, showing our new design;
FIG. 2 is a top plan view thereof;
FIG. 3 is a bottom plan view thereof;
FIG. 4 is a front view thereof;
FIG. 5 is a rear view thereof;
FIG. 6 is a side view thereof; and,
FIG. 7 is an opposite side view thereof.
The elements shown in broken lines form no part of the claimed design and are included for the purpose of showing the environment of the claimed design.

1 Claim, 7 Drawing Sheets

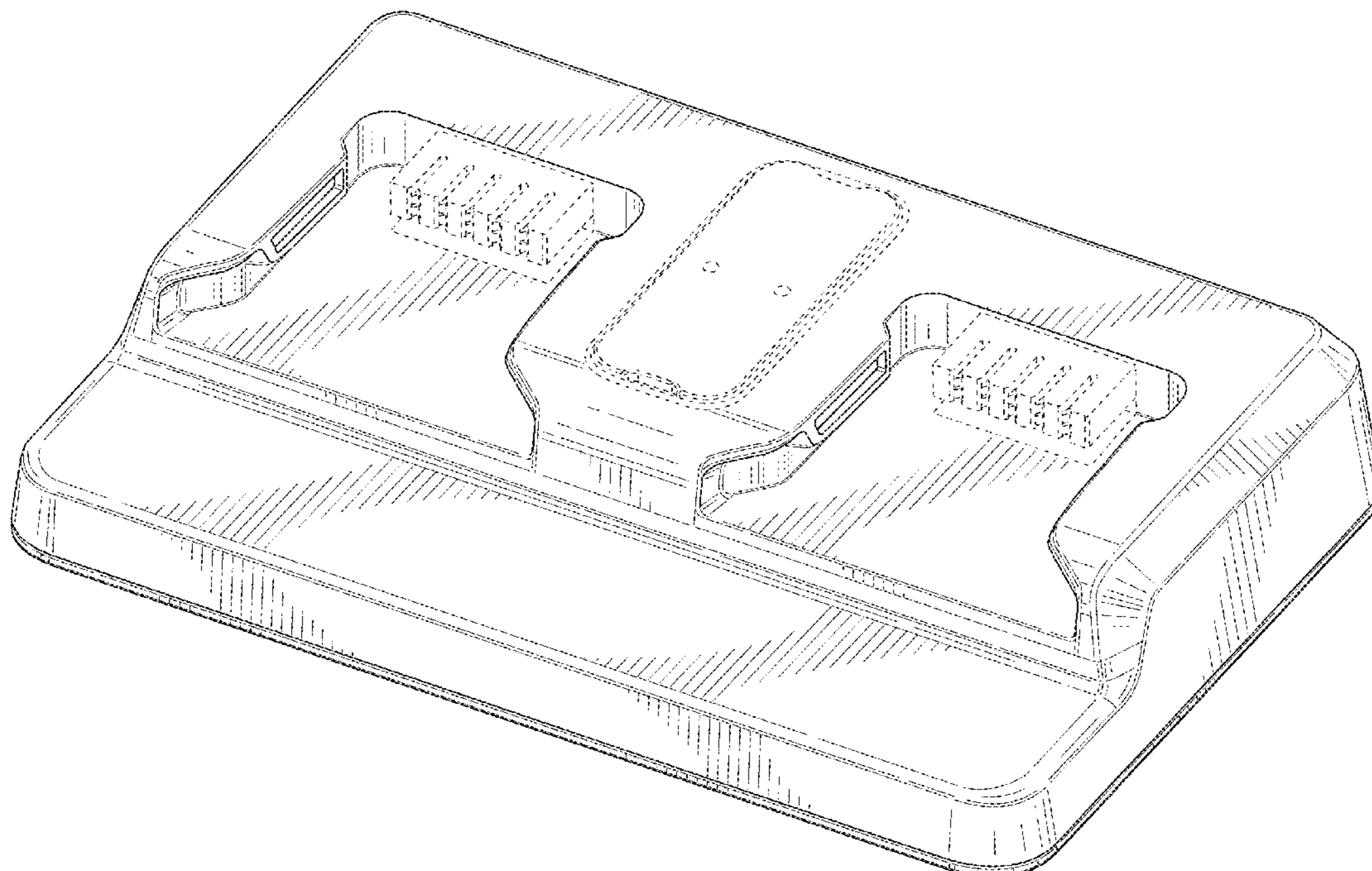

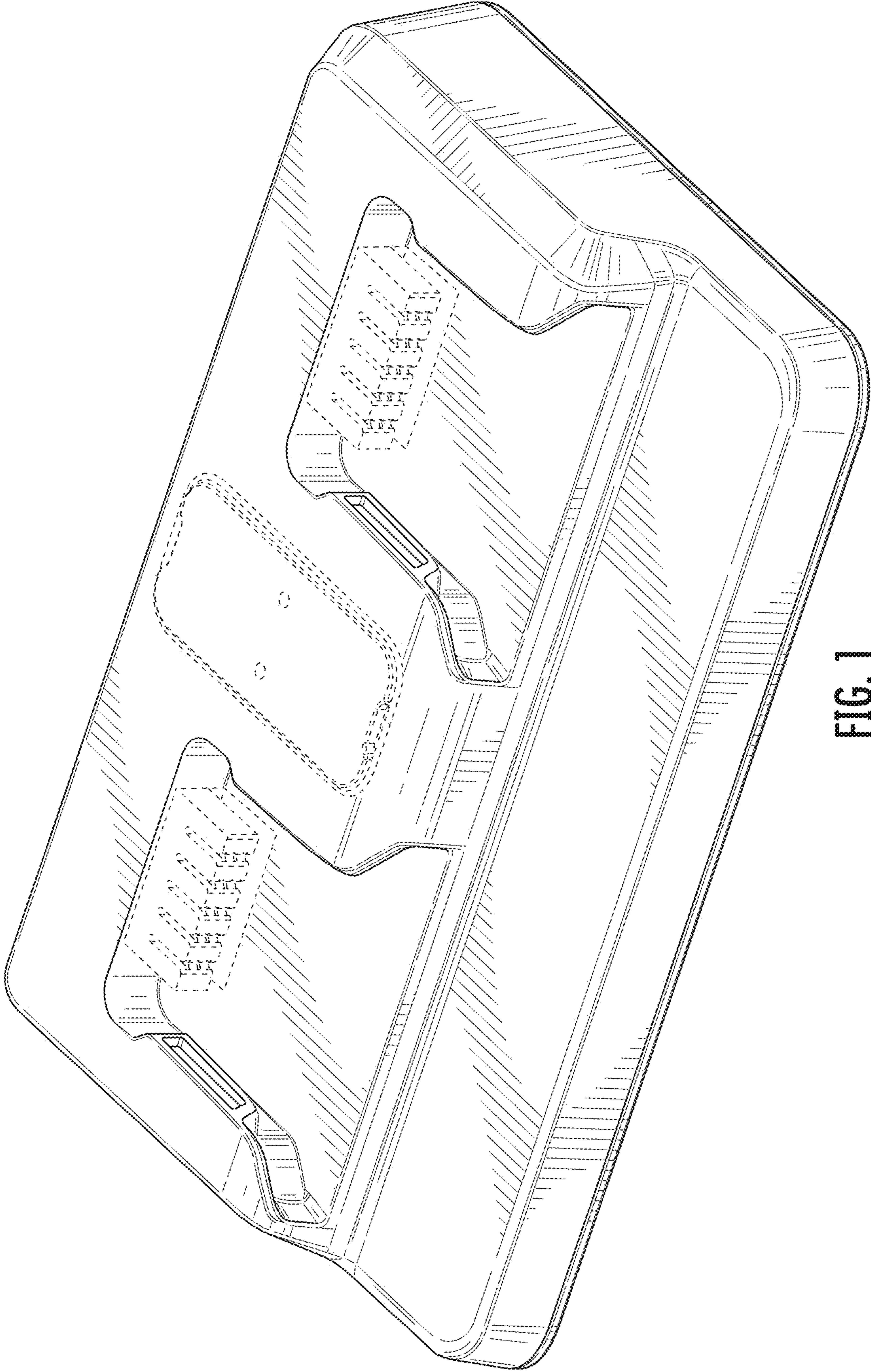

FIG. 1

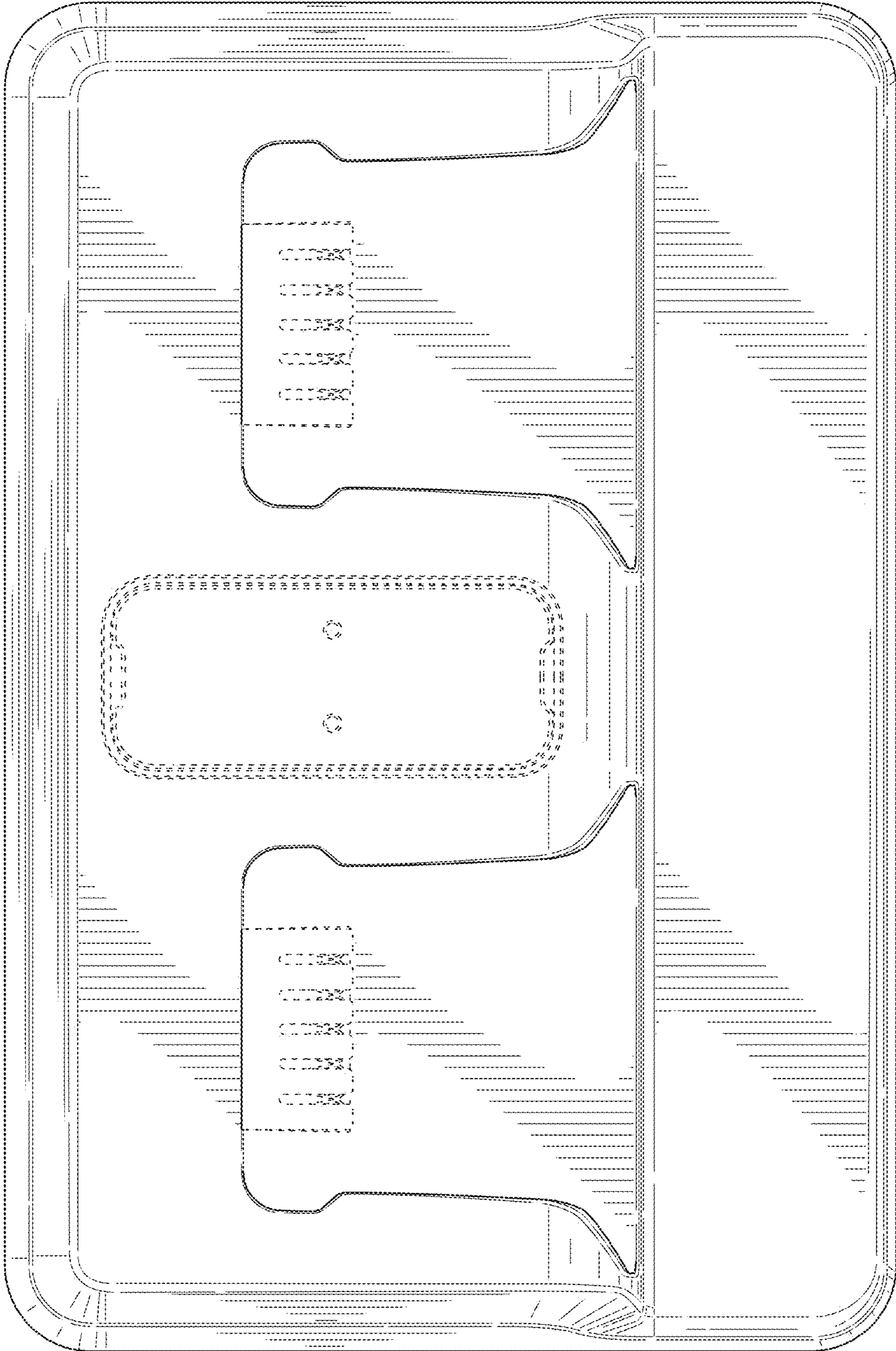

FIG. 2

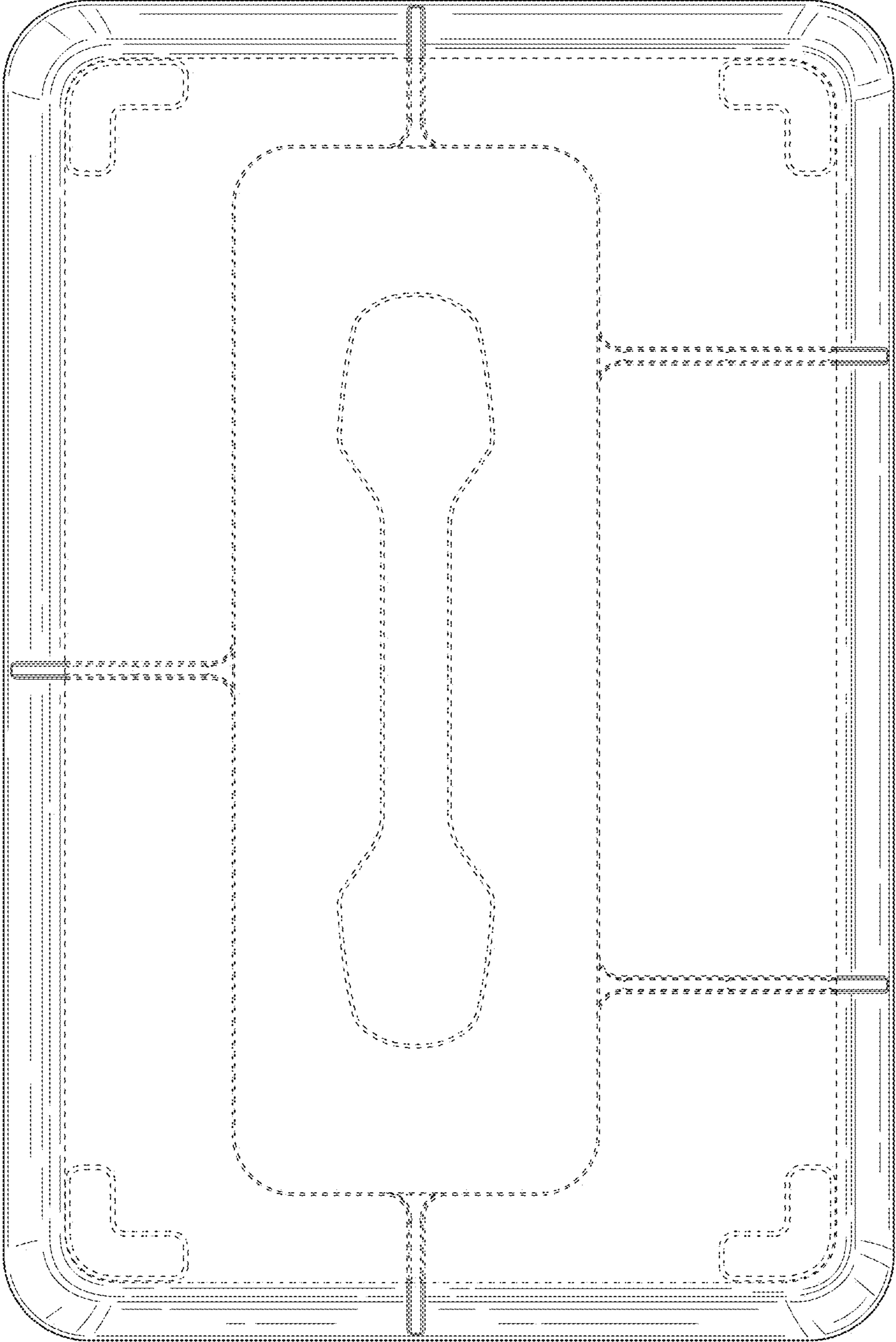

FIG. 3

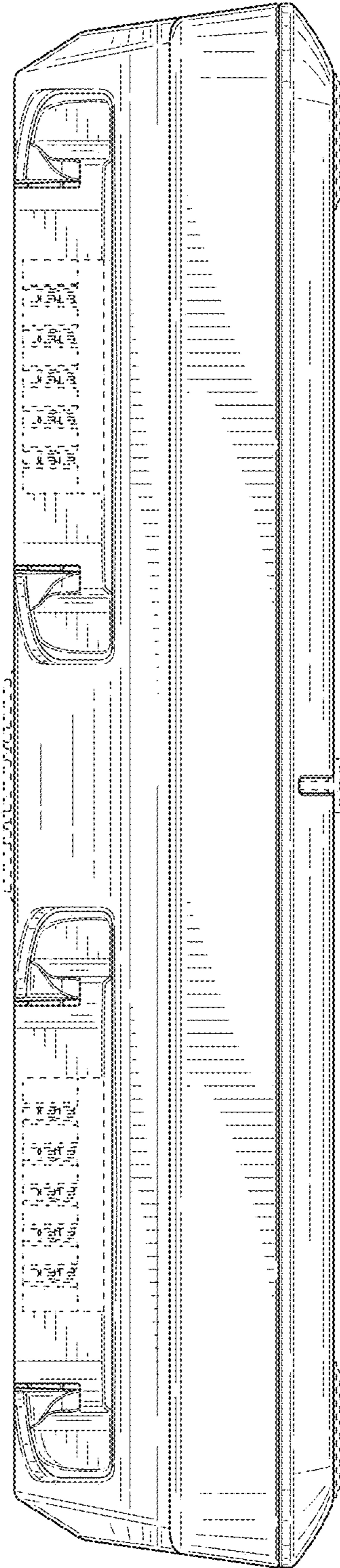

FIG. 4

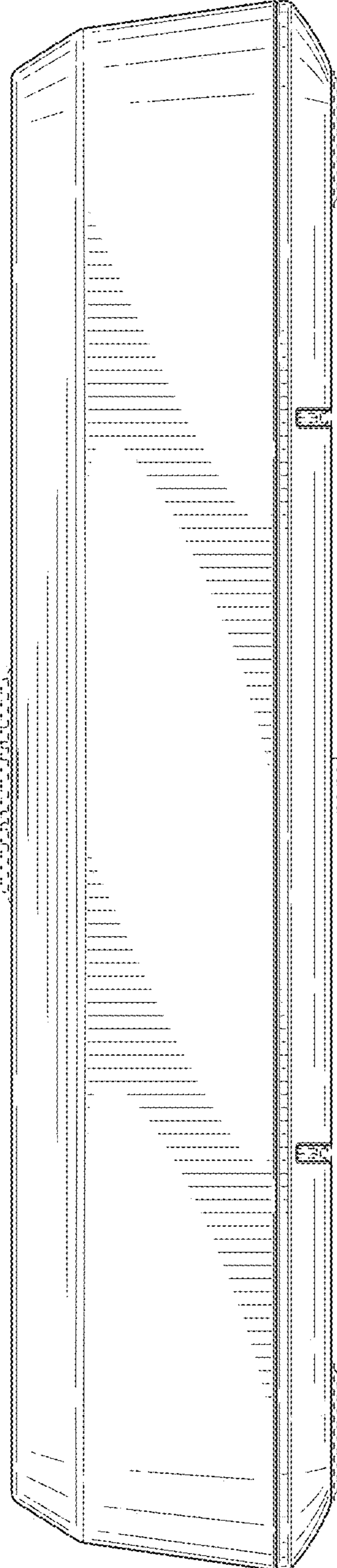

FIG. 5

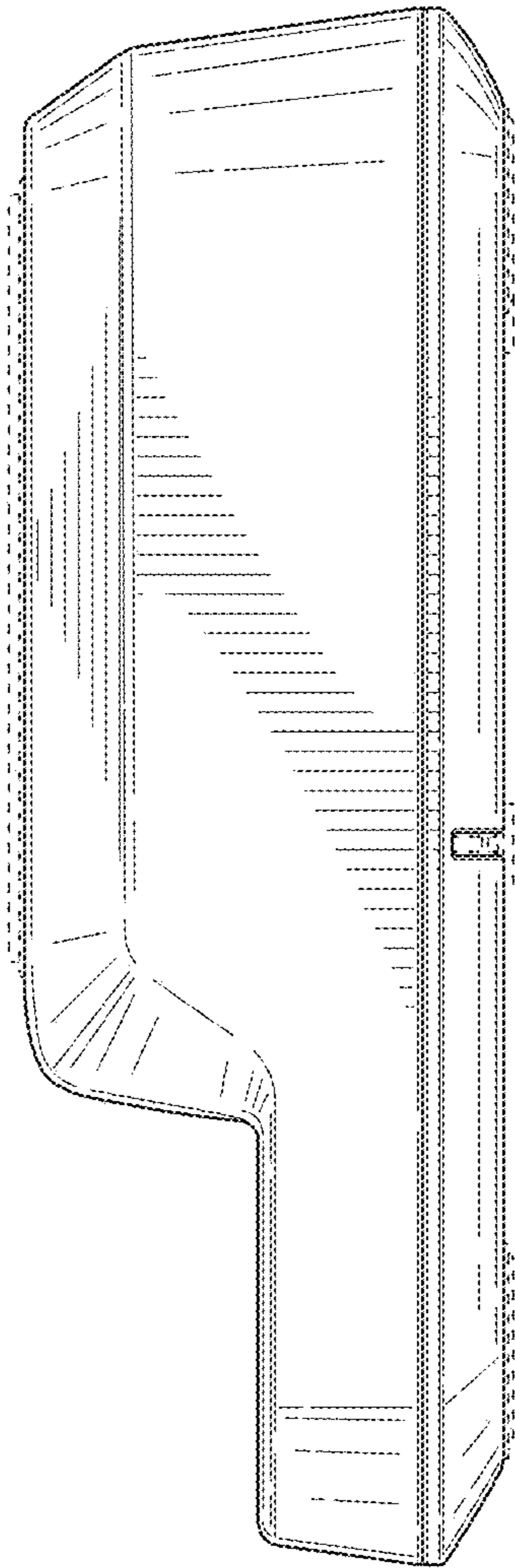

FIG. 6

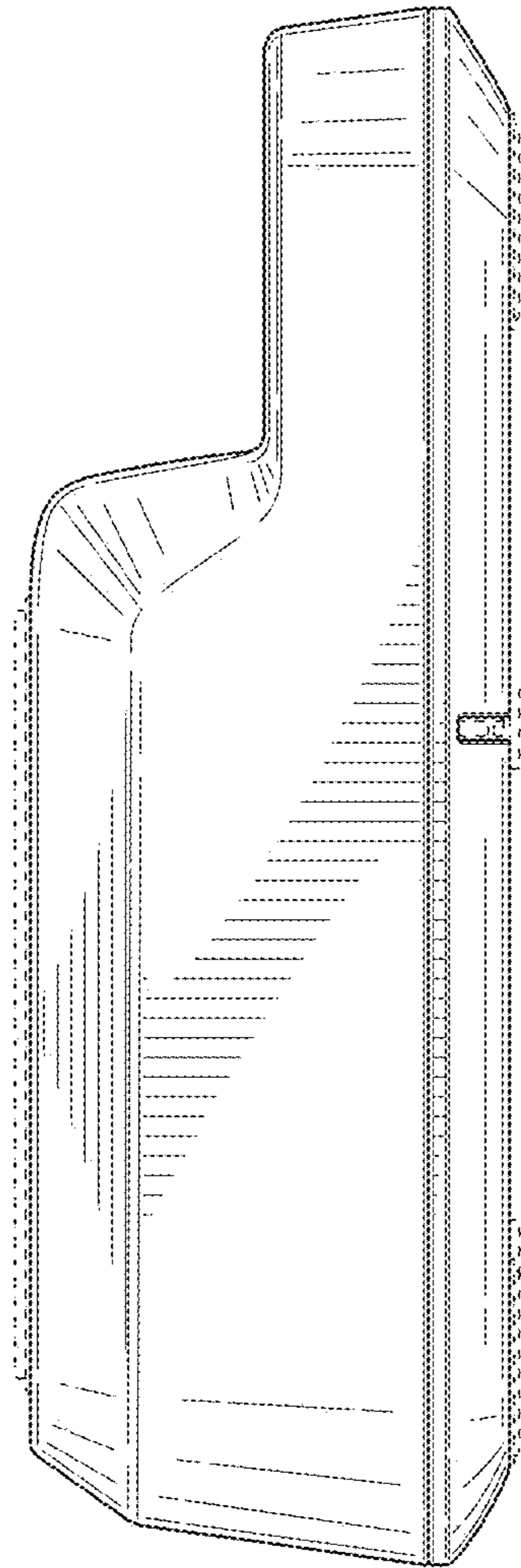

FIG. 7