



US00D900707S

(12) **United States Design Patent** (10) **Patent No.:** **US D900,707 S**
Brown (45) **Date of Patent:** **** Nov. 3, 2020**

(54) **HANDICAP PLACARD DISPLAY SHADE**
(71) Applicant: **Anthony Brown**, Fort Worth, TX (US)
(72) Inventor: **Anthony Brown**, Fort Worth, TX (US)

(**) Term: **15 Years**

(21) Appl. No.: **29/686,238**

(22) Filed: **Apr. 3, 2019**

(51) **LOC (12) Cl.** **12-16**

(52) **U.S. Cl.**
USPC **D12/401**

(58) **Field of Classification Search**
USPC D12/182, 183, 191, 184, 185, 106, 417,
D12/311, 312, 401, 400, 181;
160/370.21; 150/166, 168; 224/312;
49/502-504; 428/12; D20/10, 11, 13,
D20/19, 22, 27, 29, 31, 35, 39, 40, 42,
D20/43, 44, 99
CPC B60J 3/0208; B60J 3/02
See application file for complete search history.

(56) **References Cited**

U.S. PATENT DOCUMENTS

2,931,114	A	4/1960	Peterson	
4,652,039	A *	3/1987	Richards	B60J 1/2091 160/370.23
4,671,334	A *	6/1987	Yadegar	B60J 1/2091 160/370.23
D293,428	S *	12/1987	Watts	D12/191
4,974,655	A *	12/1990	Teachout	B60J 1/2091 160/370.23
D317,588	S *	6/1991	Pluta	D12/191
5,031,684	A *	7/1991	Soong	B60J 1/2091 160/368.1
5,123,468	A	6/1992	Mater, Jr.	
D335,481	S *	5/1993	Eskandry	D12/191
D339,098	S *	9/1993	Cooper	D12/191
D369,998	S *	5/1996	Eskandry	D12/191

5,535,808	A *	7/1996	Idesis	B60J 1/2011 160/238
5,632,318	A	5/1997	Wang	
5,660,220	A *	8/1997	Ruan	B60J 1/2091 160/370.23

(Continued)

OTHER PUBLICATIONS

NOT Crap Handicap Wheelchair Windshield Sun Shade Universal Fit Car Sunshade-Keep Your Vehicle Cool, Amazon.com, [online], [site visited Jun. 20, 2020]. <URL: https://www.amazon.com/NOT-Wheelchair-Windshield-Universal-Sunshade-Keep/dp/B088BFRR63> (Year: 2020).*

(Continued)

Primary Examiner — T Chase Nelson
Assistant Examiner — Jonathan J. Han

(57) **CLAIM**

The ornamental design for a handicap placard display shade, as shown and described.

DESCRIPTION

FIG. 1 is a front view of a handicap placard display shade showing my new design;
FIG. 2 is a rear view of the handicap placard display shade;
FIG. 3 is a right side view of the handicap placard display shade;
FIG. 4 is a left side view of the handicap placard display shade;
FIG. 5 is a top view of the handicap placard display shade;
FIG. 6 is a bottom view of the handicap placard display shade; and,
FIG. 7 is a top front side perspective view of the handicap placard display shade.
The broken lines in FIG. 7 are illustrative of environmental structure forming no part of the claimed design.

1 Claim, 4 Drawing Sheets

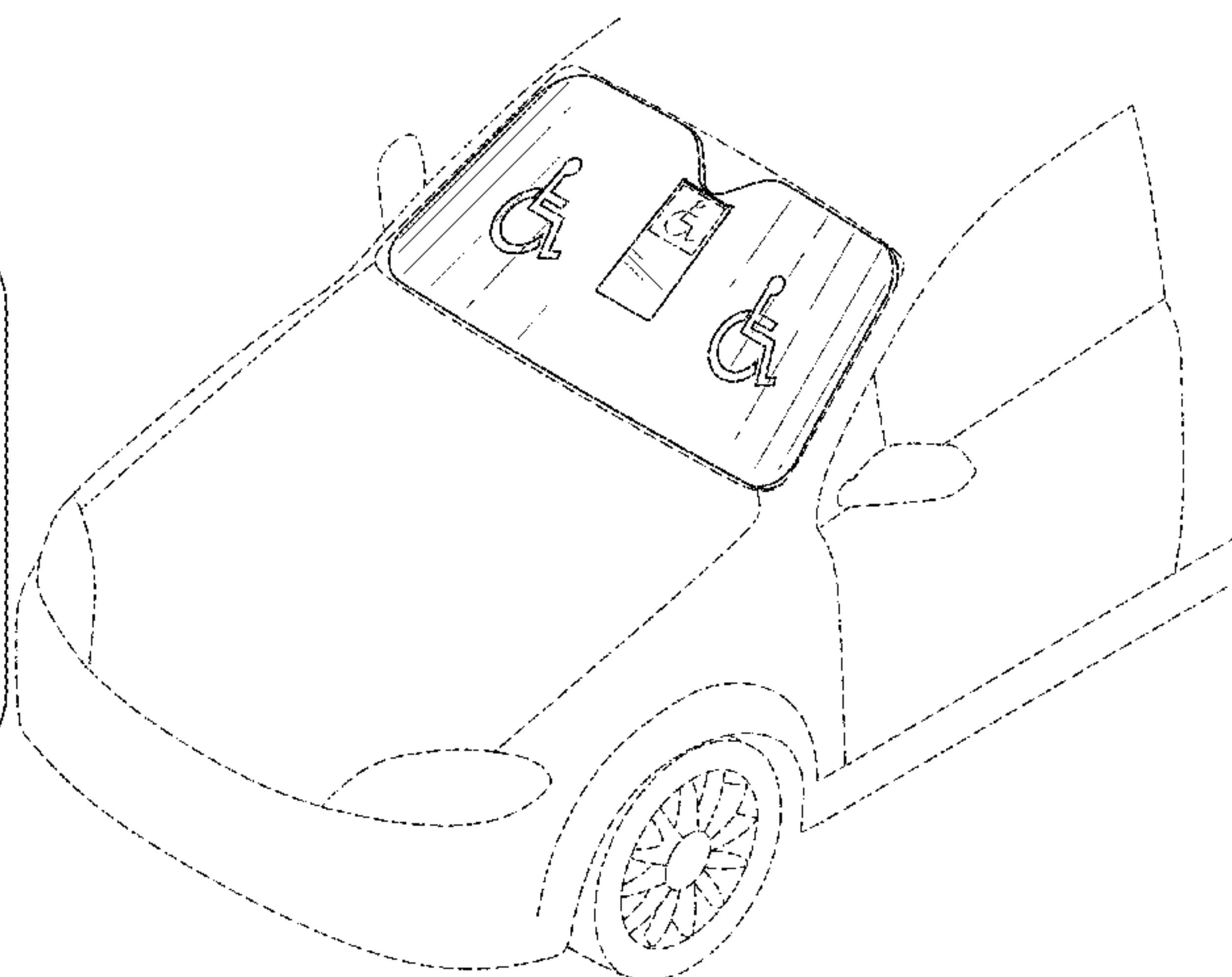
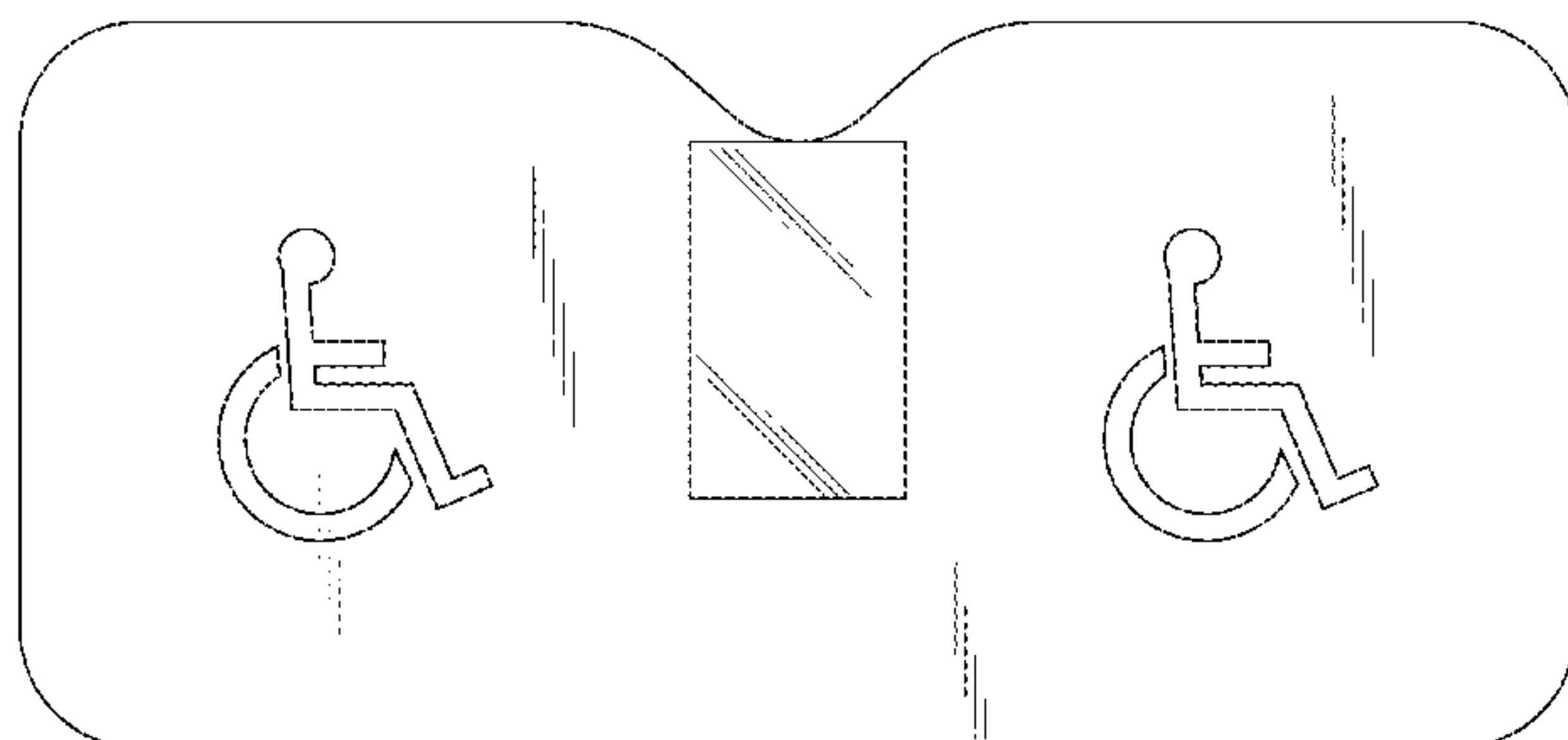

(56)

References Cited

U.S. PATENT DOCUMENTS

5,671,491 A 9/1997 Ladd
 D391,300 S 2/1998 Pater
 D410,360 S * 6/1999 Aranzazu D6/575
 D443,572 S * 6/2001 Freeman D12/182
 6,276,081 B1 8/2001 Shedd
 6,997,501 B2 2/2006 Conforti
 D536,739 S * 2/2007 Kenton D20/40
 D548,154 S * 8/2007 Eskandry D12/191
 D548,155 S * 8/2007 Eskandry D12/191
 D548,657 S * 8/2007 Eskandry D12/183
 D555,057 S * 11/2007 Eskandry D12/191
 7,686,373 B1 * 3/2010 McCabe B60R 7/05
 224/277
 D618,732 S * 6/2010 Harel D20/40
 D640,961 S * 7/2011 Ferguson D12/191
 D665,318 S * 8/2012 Eskandry D12/183
 D665,721 S * 8/2012 Beachy D12/401
 D666,136 S * 8/2012 Beachy D12/401
 D671,465 S * 11/2012 Ferguson D12/191

D707,597 S * 6/2014 Eskandry D12/183
 D710,774 S * 8/2014 Eskandry D12/183
 D721,628 S * 1/2015 Eskandry D12/183
 D750,259 S * 2/2016 Lau D24/183
 D861,793 S * 10/2019 Handelsman D20/11
 2011/0067278 A1 3/2011 Hulbert
 2015/0101768 A1 * 4/2015 Lee B60J 1/2091
 160/370.21
 2017/0113519 A1 * 4/2017 Gong B60J 1/2011
 2017/0313162 A1 * 11/2017 Brown B60J 1/2091
 2019/0047378 A1 * 2/2019 Yamada C03C 17/22

OTHER PUBLICATIONS

Visor Pocket, HarrietCarter.com, [online], [site visited Jun. 20, 2020]. <URL: <https://www.harrietcarter.com/household/travel-auto/visor-pocket/712151.html>> (Year: 2020).
 Polyurethane Car Sun Shade, QualityLogoProducts.com, [online], [site visited Jun. 20, 2020]. <URL: <https://www.qualitylogoproducts.com/tradeshows-promotions/car-sun-shade.htm>> (Year: 2020).*

* cited by examiner

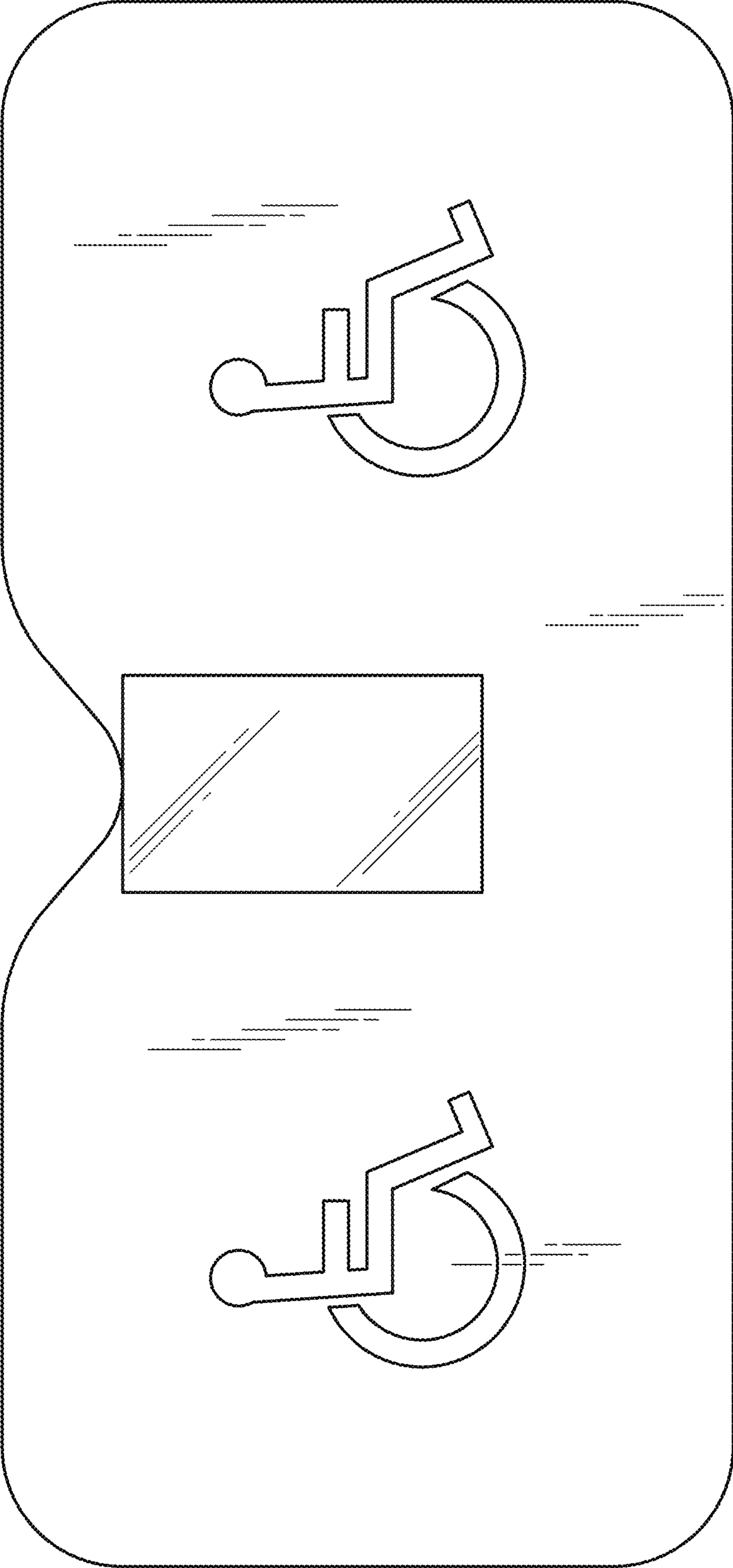

FIG. 1

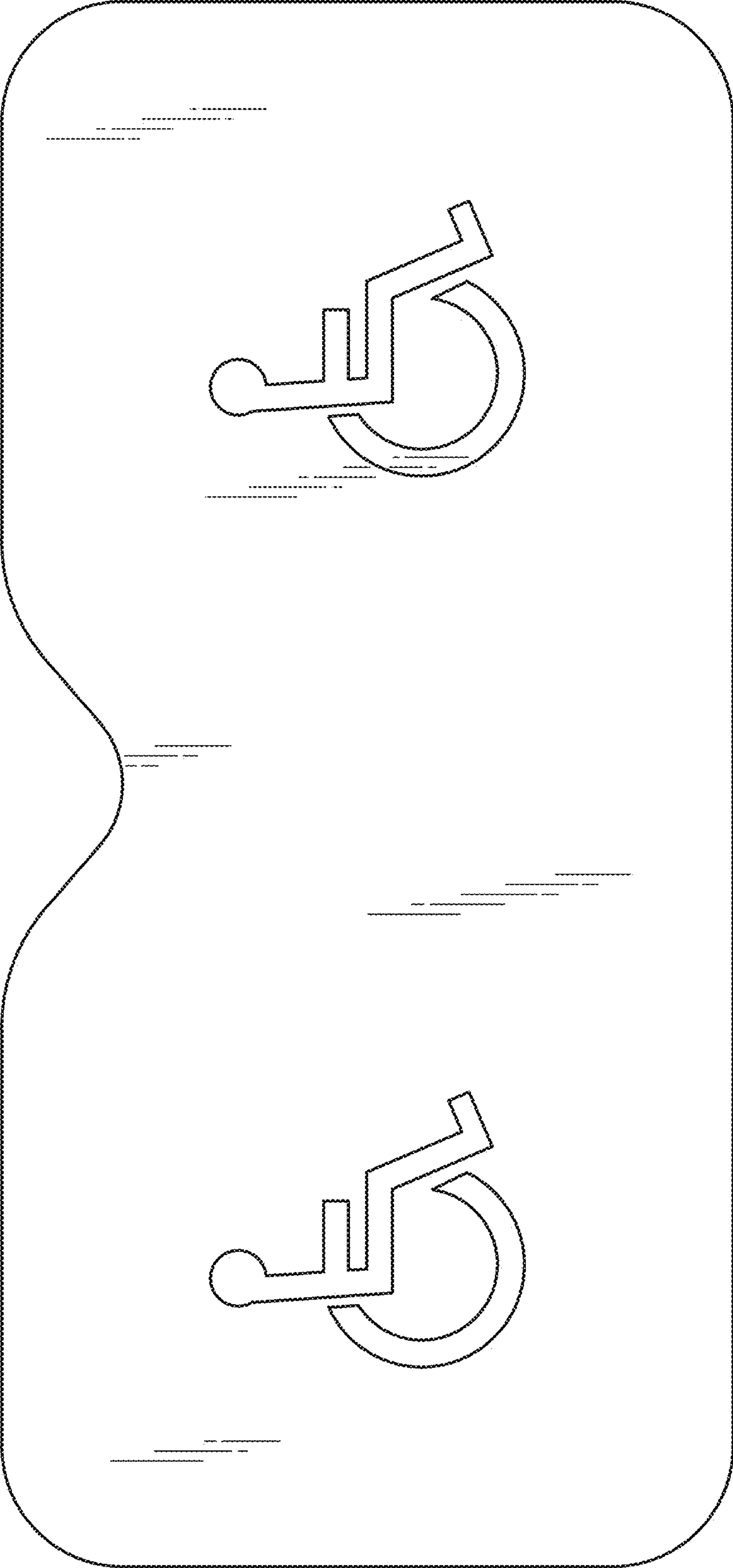

FIG. 2

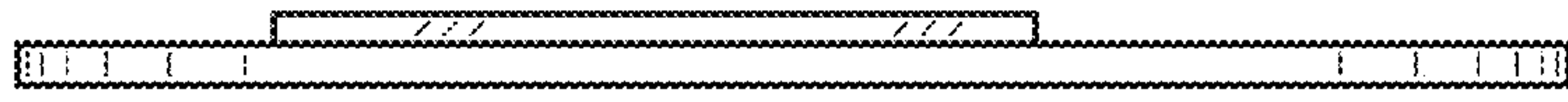

FIG. 3

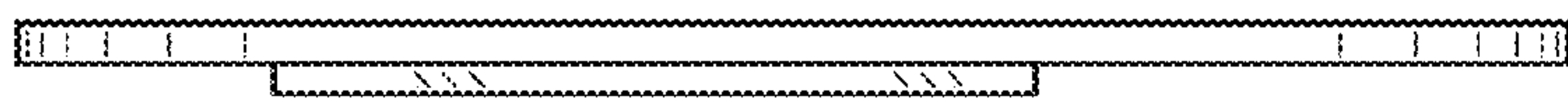

FIG. 4



FIG. 5



FIG. 6

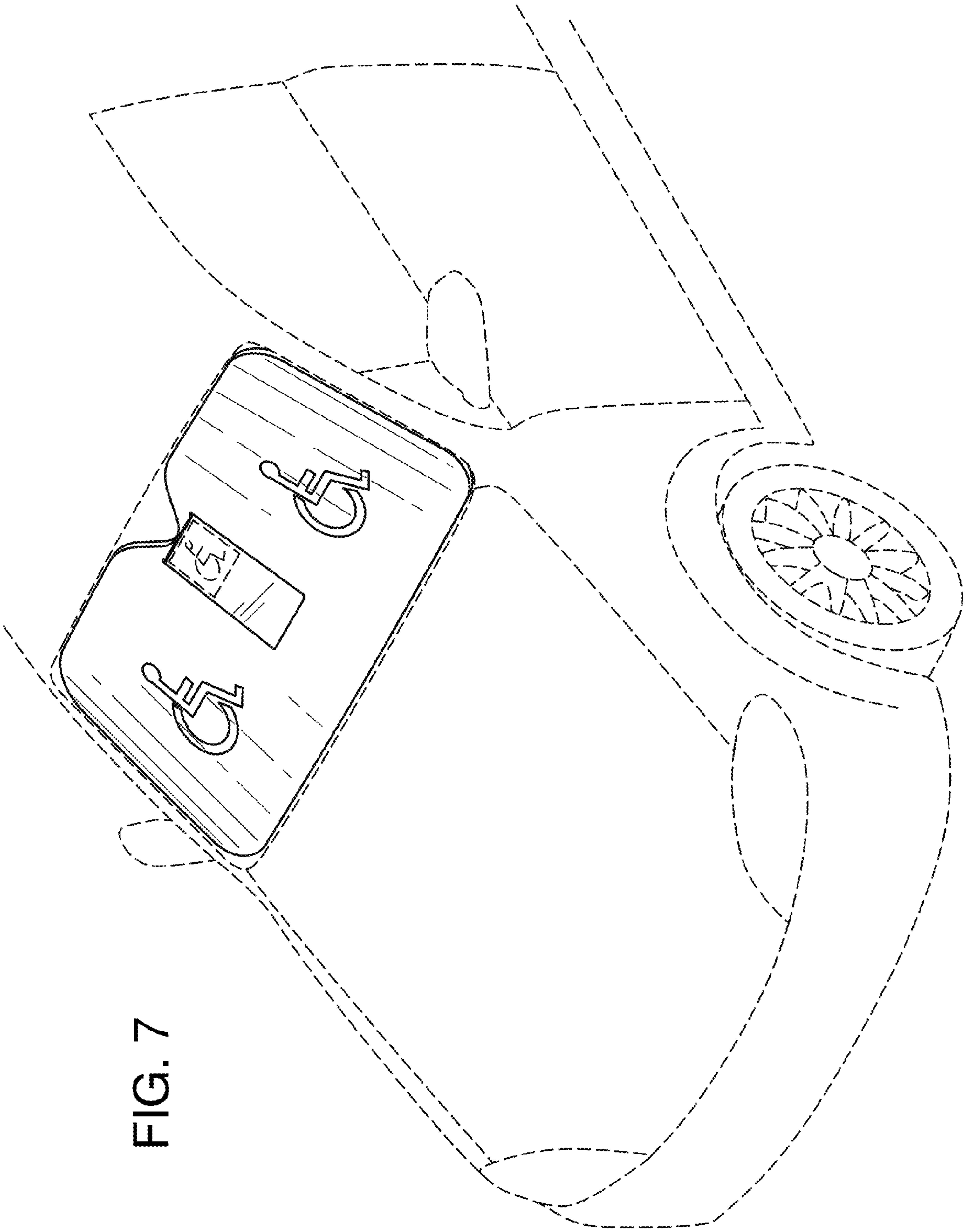

FIG. 7