



US00D900666S

(12) **United States Design Patent**
Gad

(10) **Patent No.:** **US D900,666 S**

(45) **Date of Patent:** **** Nov. 3, 2020**

(54) **PENDANT**

(71) Applicant: **FINESSE DIAMOND, CORP.**, New York, NY (US)

(72) Inventor: **Steven Gad**, New York, NY (US)

(73) Assignee: **FINESSE DIAMOND, CORP.**, New York, NY (US)

(**) Term: **15 Years**

(21) Appl. No.: **29/683,056**

(22) Filed: **Mar. 11, 2019**

(51) **LOC (12) Cl.** **11-01**

(52) **U.S. Cl.**
USPC **D11/79**

(58) **Field of Classification Search**
USPC D11/1-20, 30, 37, 38, 40, 43, 48, 56, 61,
D11/75, 76, 79-83, 86, 91, 34-36;
D10/33, 34, 35, 36, 39, 126
CPC A44C 3/00; A44C 3/001; A44C 3/004;
A44C 3/005; A44C 3/008; A44C 15/001;
A44C 15/0005; A44C 15/0045; A44C
5/00; A44C 7/00; A44C 25/00; A44C
25/002; A44C 25/007; A44C 25/008;
A44C 1/00
See application file for complete search history.

(56) **References Cited**

U.S. PATENT DOCUMENTS

- 1,668,217 A * 5/1928 Schraysshuen A44C 11/007
63/3
- D191,757 S * 11/1961 Jacobi D11/89
- D226,675 S * 4/1973 Gange D11/82
- D267,860 S * 2/1983 Kabaya D10/32
- D450,615 S * 11/2001 Ambar D11/76
- D656,418 S * 3/2012 Scheufele D10/39
- D672,269 S * 12/2012 Wong D11/91
- D699,146 S * 2/2014 Dholakiya D11/91
- D704,589 S * 5/2014 Daniels Christensen
A44C 5/00
D11/7

- D801,845 S * 11/2017 Blootacker D10/126
- D803,718 S * 11/2017 Pierce D11/121
- 9,820,538 B2 * 11/2017 Lebreton A44C 27/001
- D816,534 S * 5/2018 Barouch D11/5
- D832,127 S * 10/2018 Grois D11/2

(Continued)

OTHER PUBLICATIONS

Bony Levy Circular Diamond Medallion, no date available, [online], [site visited Jan. 24, 2020]. Retrieved from url:https://shop.nordstrom.com/s/bony-levy-circular-diamond-medallion-pendant-necklace-nordstrom-exclusive/5246207/lite (Year: 2020).*

(Continued)

Primary Examiner — Michelle E. Wilson

Assistant Examiner — Tracey J Bell

(74) *Attorney, Agent, or Firm* — Banner & Witcoff, Ltd.

(57) **CLAIM**

The ornamental design for a pendant, as shown and described.

DESCRIPTION

FIG. 1 is a front view of a pendant showing my new design; FIG. 2 is a rear view thereof; FIG. 3 is a right side view thereof; FIG. 4 is a left side view thereof; FIG. 5 is a top view thereof; FIG. 6 is a bottom view thereof; FIG. 7 is a front perspective view thereof; and, FIG. 8 is a front view of the pendant of FIGS. 1-7 showing a stone region in a changed state of appearance relative to FIGS. 1-7.

The stippling shown on the stone region in FIG. 8 represents a contrast of appearance with respect to remaining stones and the change of state if affected.

The broken lines depict portions of the pendant that form no part of the claimed design.

1 Claim, 6 Drawing Sheets

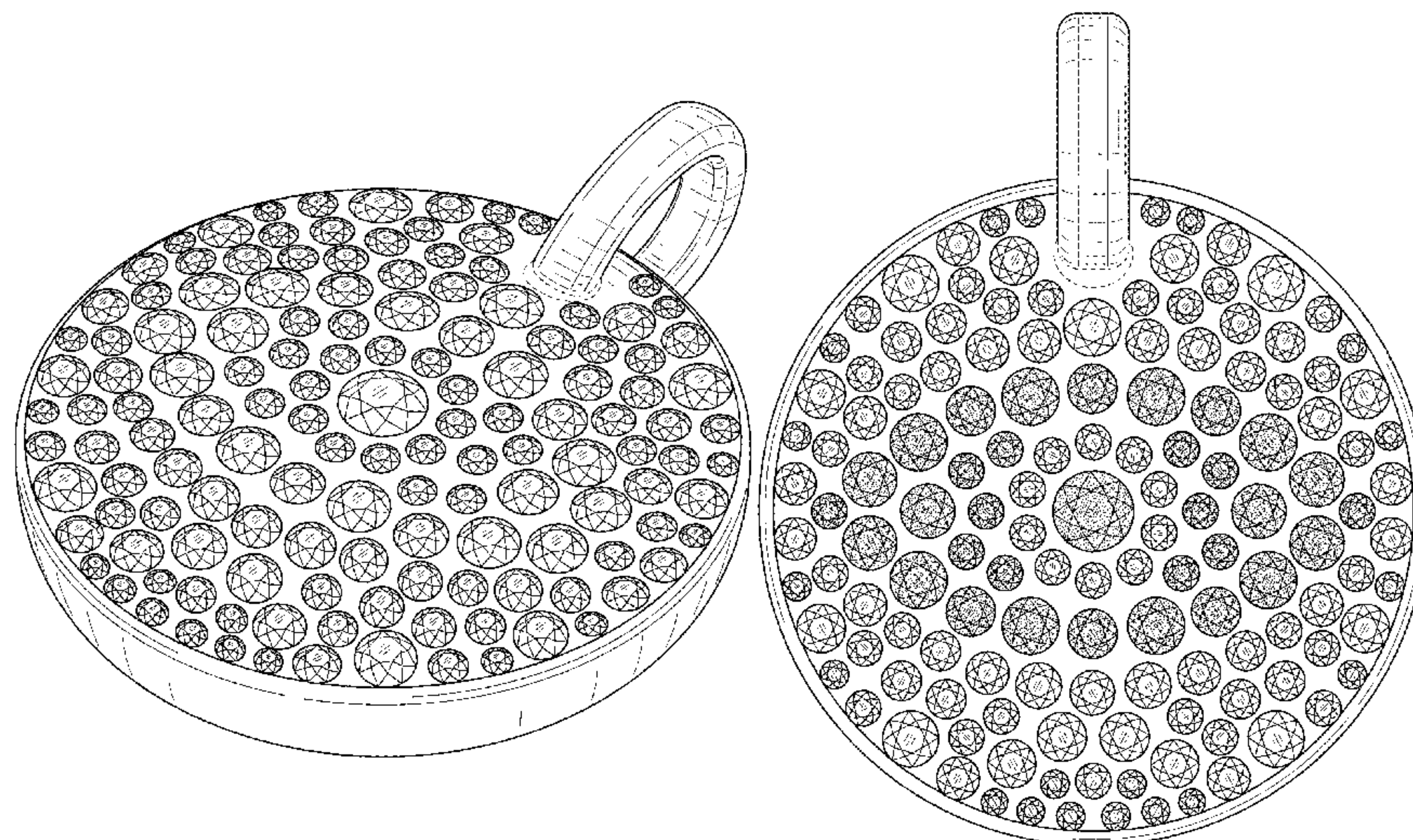

(56)

References Cited

U.S. PATENT DOCUMENTS

D849,588 S * 5/2019 Sivriere D11/79
D881,062 S * 4/2020 Gad D11/79
2008/0016915 A1* 1/2008 Shah A44C 13/00
63/40

OTHER PUBLICATIONS

Nordstrom Ragen Jewels Evil Eye, no date available, [online], [site visited Feb. 10, 2020]. Retrieved from url:<https://shop.nordstrom.com/s/ragen-jewels-evil-eye-disc-pendant-necklace/5406063/full?origin=keywordsearch-personalizedsort&breadcrumb=Home%2FAll%20Results&color=silver> (Year: 2020).*

Apartmentf15_ evil eye jewelry, Jul. 4, 2012, [online], [site visited Feb. 10, 2020]. Retrieved from url:<http://apartmentf15.blogspot.com/2012/07/evil-eye-jewelry.html> (Year: 2012).*

Anne Sisteron Diamond Sapphire Evil Eye Charm, no date available, [online], [site visited Feb. 10, 2020]. Retrieved from url:<https://annesisteron.com/products/14kt-yellow-gold-diamond-sapphire-evil-eye-charm-pendant> (Year: 2020).*

Macy's Michael Kors Evil Eye Necklace, no date available, [online], [site visited Feb. 10, 2020]. Retrieved from url:<https://www.macys.com/shop/product/michael-kors-womens-custom-kors-14k-gold-plated-sterling-silver-evil-eye-necklace?ID=7342807&CategoryID=9569> (Year: 2020).*

* cited by examiner

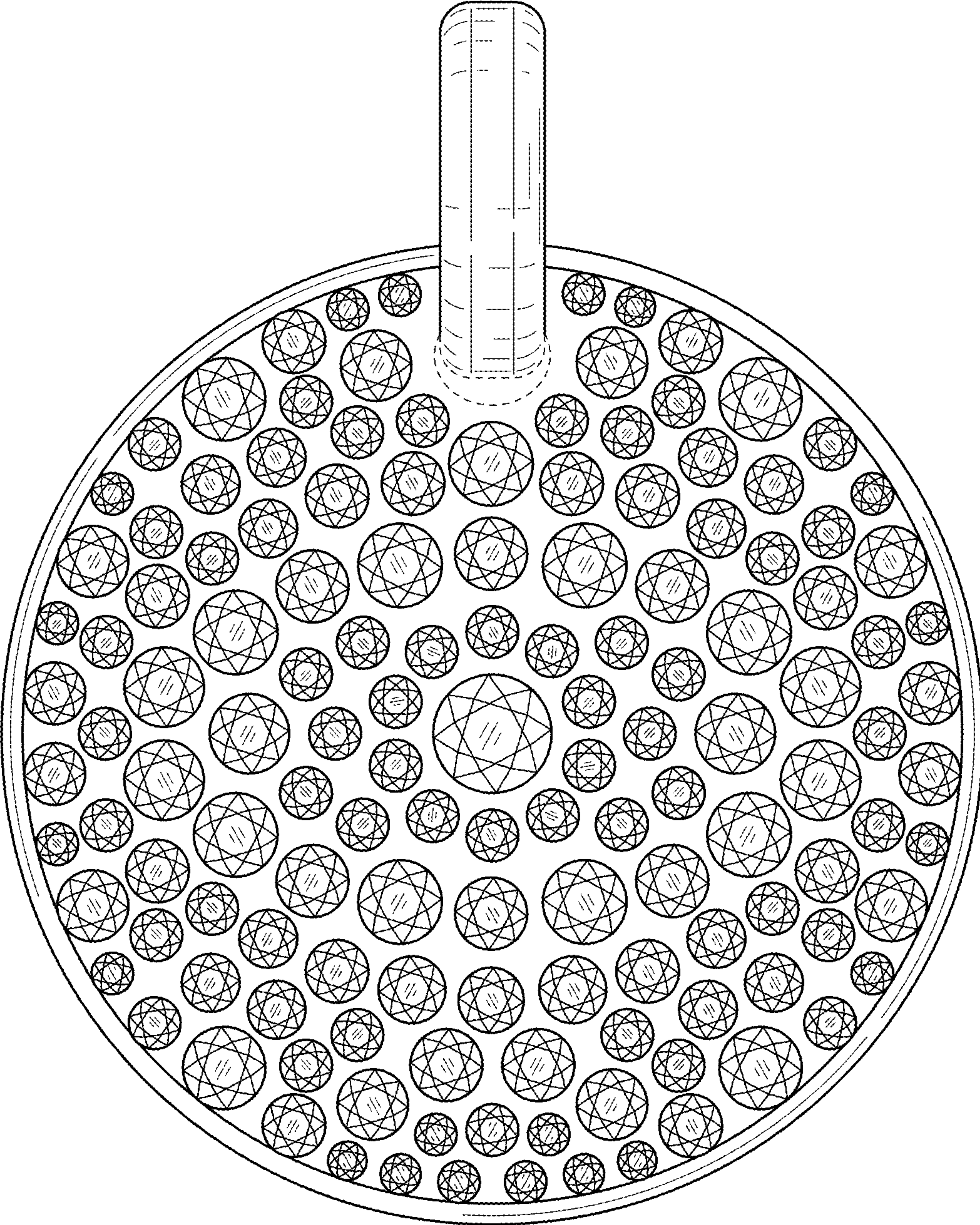

FIG. 1

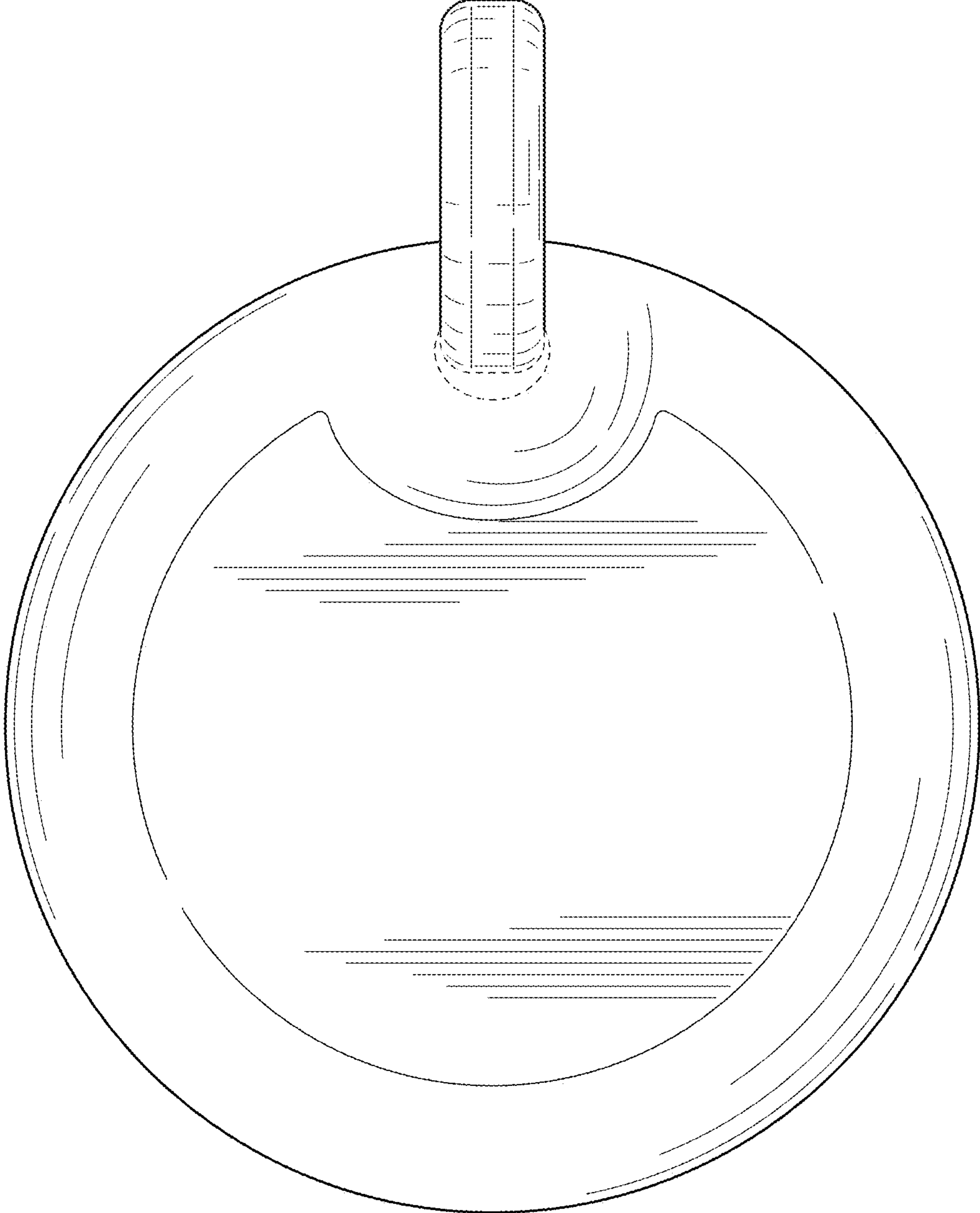

FIG. 2

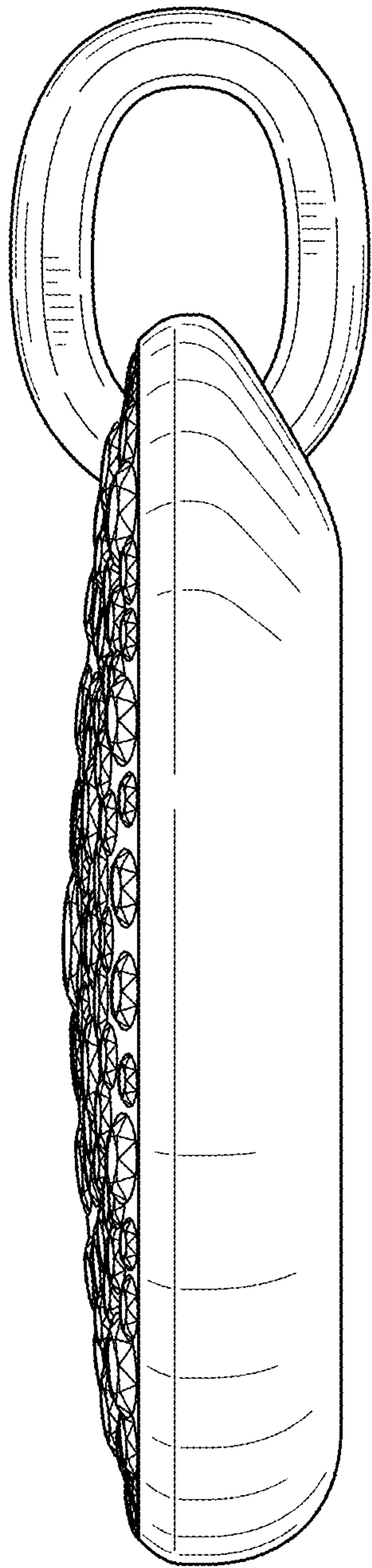

FIG. 3

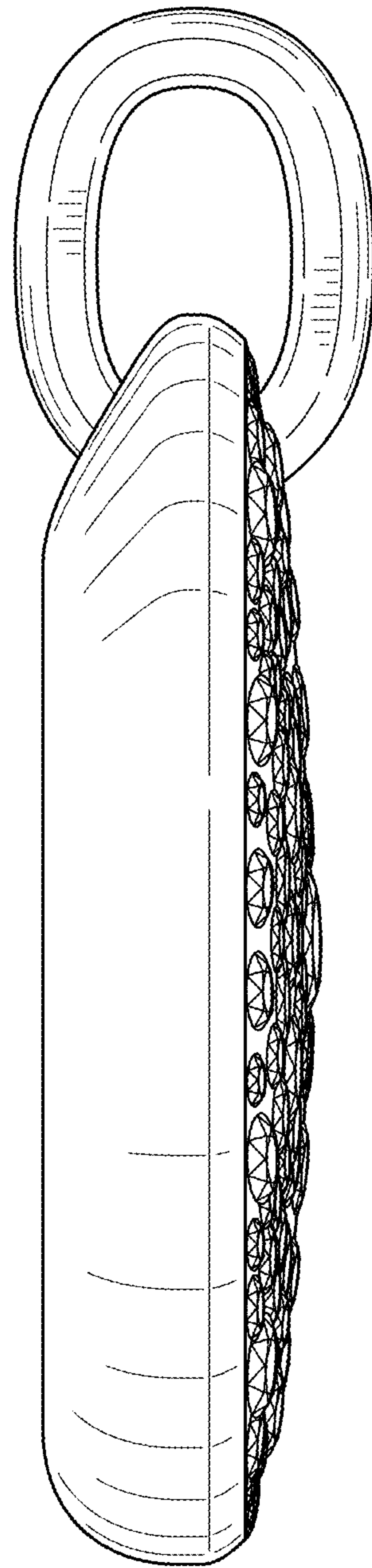

FIG. 4

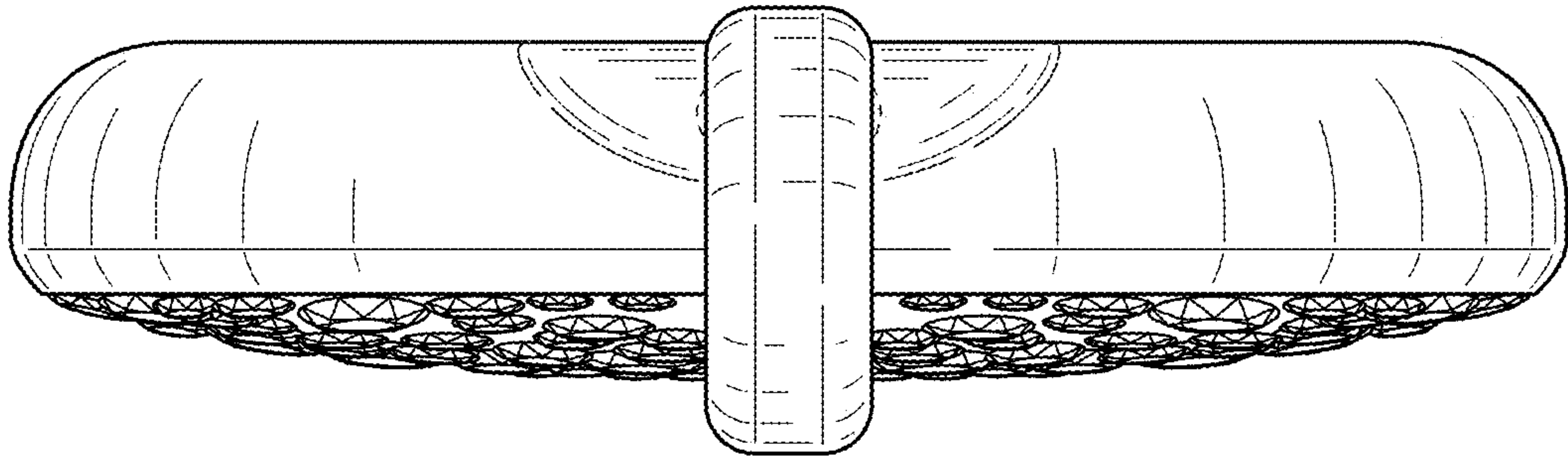

FIG. 5

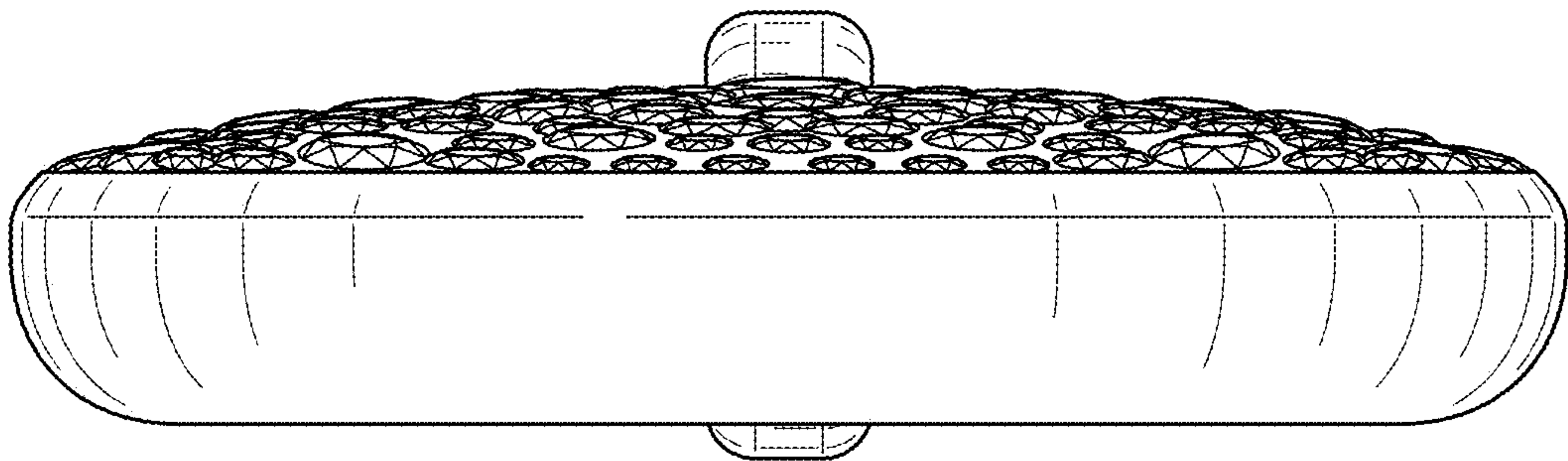

FIG. 6

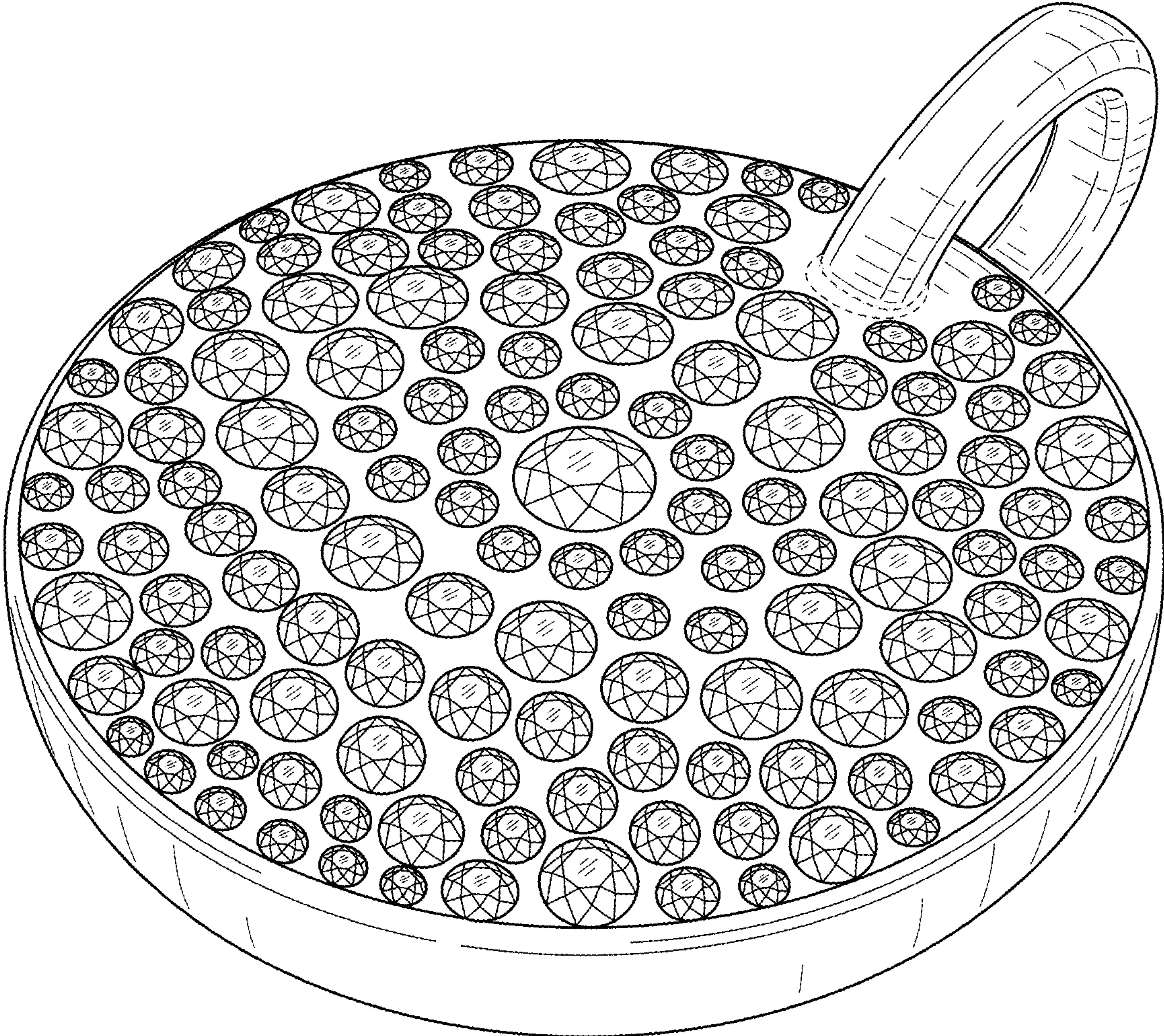

FIG. 7

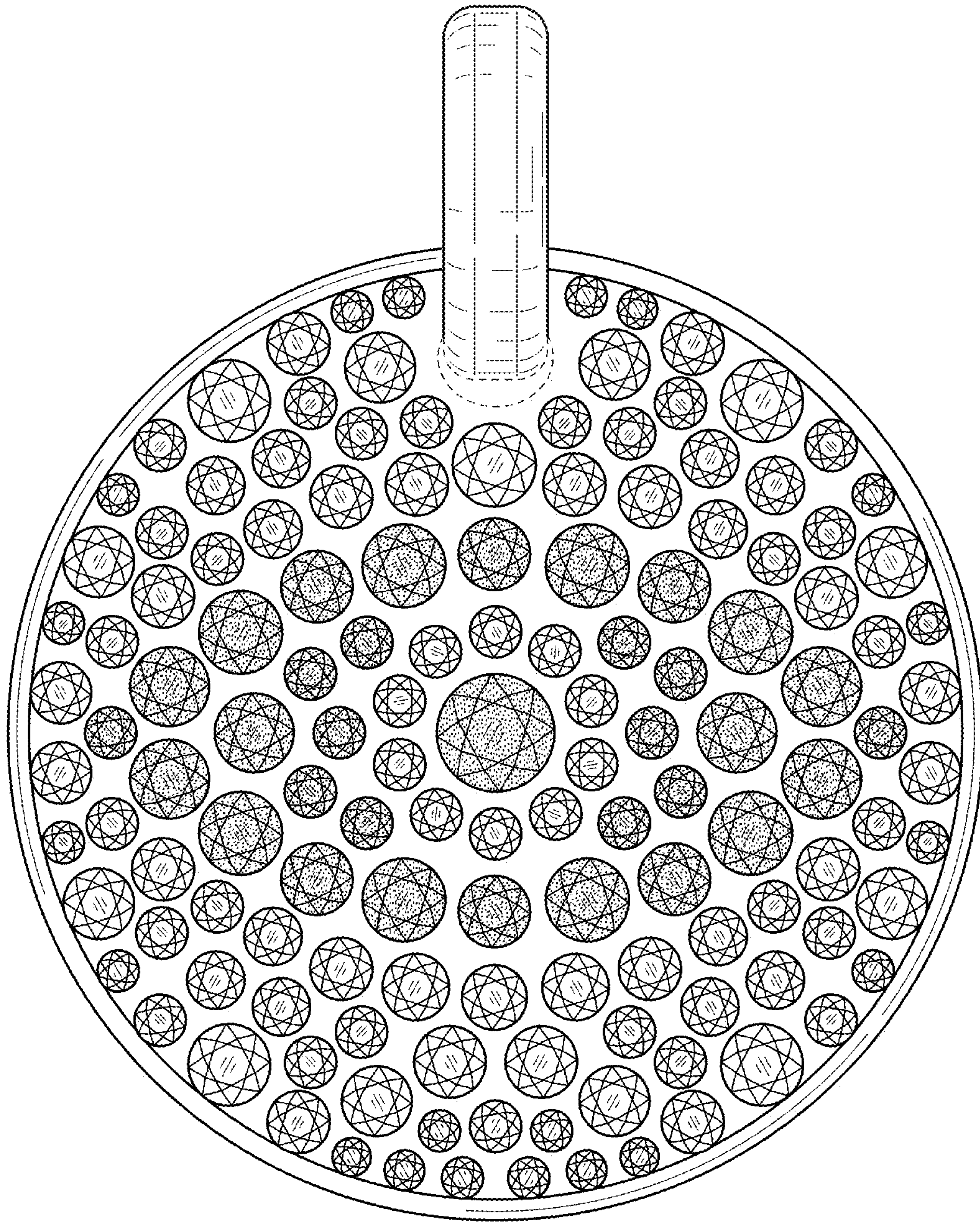

FIG. 8