



US00D900572S

(12) **United States Design Patent**
Roberts et al.

(10) **Patent No.:** **US D900,572 S**
(45) **Date of Patent:** **** Nov. 3, 2020**

- (54) **TOOL**
- (71) Applicant: **Oetiker Tool Corporation**, Branford, CT (US)
- (72) Inventors: **Jeremy Roberts**, Guilford, CT (US);
Joshua Schafer, Meriden, CT (US)
- (73) Assignee: **OETIKER TOOL CORPORATION**, Branford, CT (US)
- (**) Term: **15 Years**
- (21) Appl. No.: **29/662,722**
- (22) Filed: **Sep. 7, 2018**
- (51) **LOC (12) Cl.** **08-05**
- (52) **U.S. Cl.**
USPC **D8/52**
- (58) **Field of Classification Search**
USPC D8/4, 5, 14, 51, 52, 53, 54, 55, 56, 57,
D8/58, 59, 60, 105
CPC B25B 7/10
See application file for complete search history.

7,434,440 B2	10/2008	Fay	
7,628,052 B2	12/2009	Zhang	
D628,036 S	11/2010	Steiner	
7,823,433 B2 *	11/2010	Zhang	B25B 27/146 72/409.01
D637,054 S *	5/2011	Schleiminger	D8/52
7,954,356 B1 *	6/2011	Erbrick	B21D 39/048 72/409.12
8,015,853 B2 *	9/2011	Steiner	B21D 39/048 72/409.01
D648,995 S *	11/2011	Chang	D8/52
8,127,589 B2	3/2012	Battenfeld	
8,312,755 B1	11/2012	Steiner et al.	
8,418,519 B2 *	4/2013	Persson	B25B 7/00 72/409.01
D686,052 S	7/2013	Steiner	
D691,435 S *	10/2013	Nies	D8/5
8,584,503 B1	11/2013	Steiner et al.	
8,726,713 B2	5/2014	Steiner et al.	
D722,851 S *	2/2015	Constantine	D8/52
D741,675 S	10/2015	Gibson et al.	
D772,033 S *	11/2016	Groten	D8/52

(Continued)

Primary Examiner — Cynthia R Underwood
(74) *Attorney, Agent, or Firm* — Cantor Colburn LLP

(57) **CLAIM**

We claim, the ornamental design for a tool, as shown and described.

DESCRIPTION

FIG. 1 is a front view of a first embodiment of the invention; FIG. 2 is a rear view of the embodiment of FIG. 1; FIG. 3 is a first side view of the embodiment of FIG. 1; FIG. 4 is a second side view of the embodiment of FIG. 1; FIG. 5 is a first end view of the embodiment of FIG. 1; FIG. 6 is a second end view of the embodiment of FIG. 1; and, FIG. 7 is a perspective view of the embodiment of FIG. 1.

1 Claim, 7 Drawing Sheets

(56) **References Cited**

U.S. PATENT DOCUMENTS

2,244,482 A *	6/1941	Baxter	H01R 43/042 72/409.11
3,084,575 A *	4/1963	Klein	H01R 43/042 72/409.11
4,170,154 A	10/1979	Izraeli	
5,931,067 A *	8/1999	Gold	B25B 7/12 81/342
6,128,943 A	10/2000	Lemmens	
D455,325 S *	4/2002	Steiner	D8/51
7,000,448 B2	2/2006	Hamm et al.	
D532,672 S	11/2006	Steiner	
D534,412 S	1/2007	Steiner	

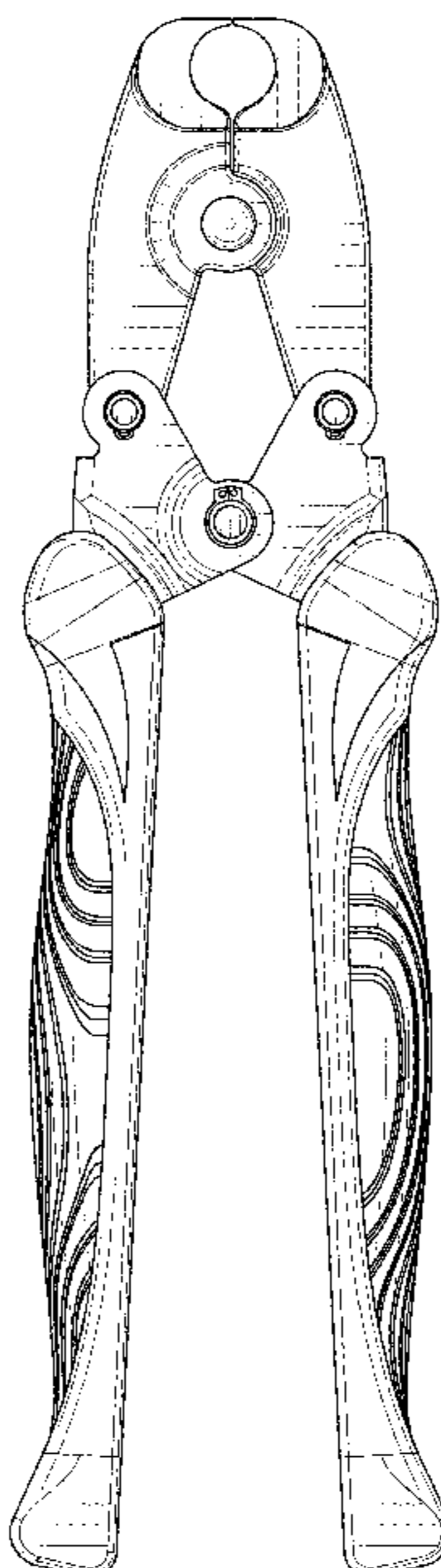

(56)

References Cited

U.S. PATENT DOCUMENTS

D778,701	S	*	2/2017	Gargano	D8/52
D783,377	S	*	4/2017	Gargano	D8/52
D796,927	S	*	9/2017	Konnecke	D8/52
D828,132	S	*	9/2018	Wang	D8/52
2002/0092336	A1		7/2002	Wagner		
2004/0144154	A1		7/2004	Steiner		
2004/0255468	A1	*	12/2004	Chang	B26B 17/02 30/192
2007/0289353	A1	*	12/2007	Fiorisi	B25B 27/10 72/409.19
2008/0078273	A1		4/2008	Steiner et al.		
2008/0163664	A1		7/2008	Battenfeld		
2008/0216548	A1		9/2008	Steiner et al.		

* cited by examiner

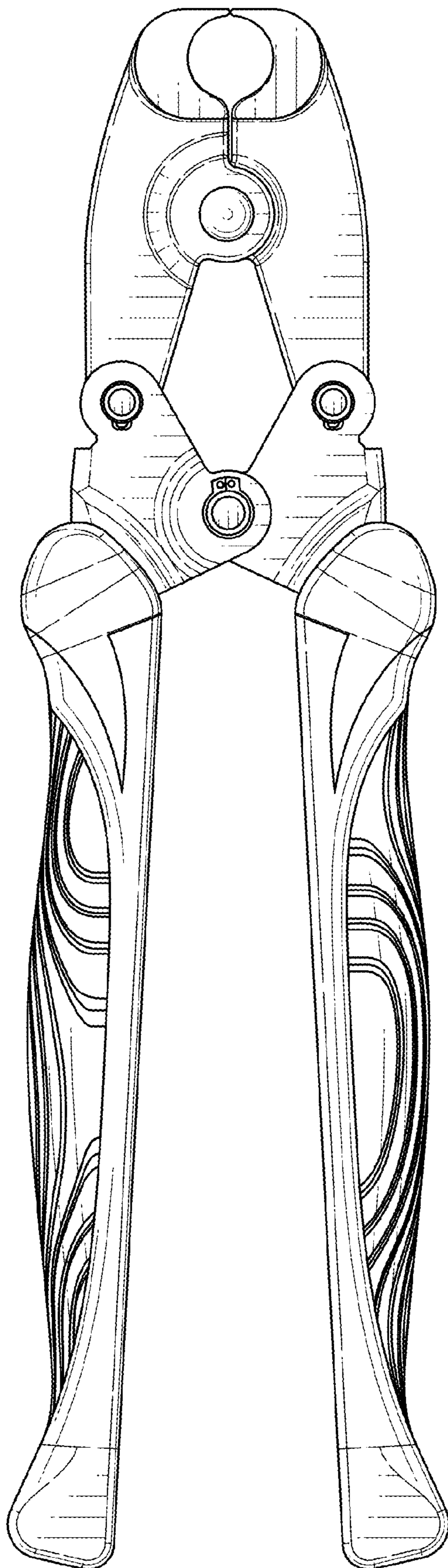

FIG. 1

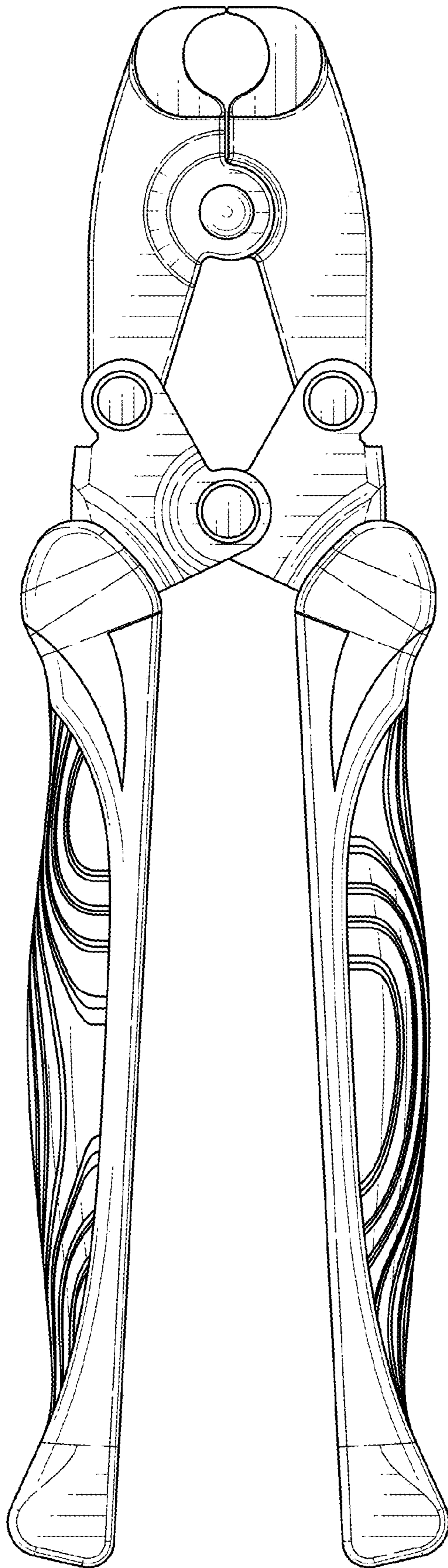

FIG. 2

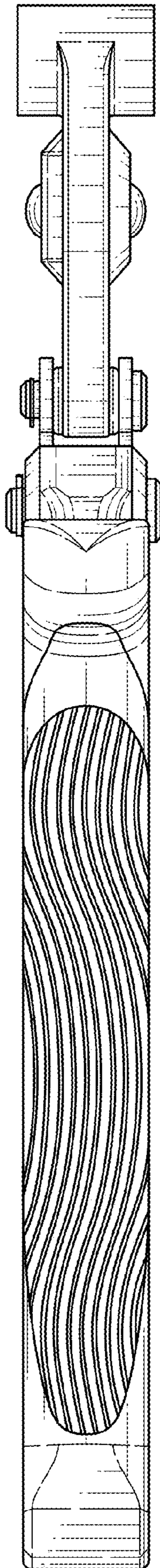

FIG. 3

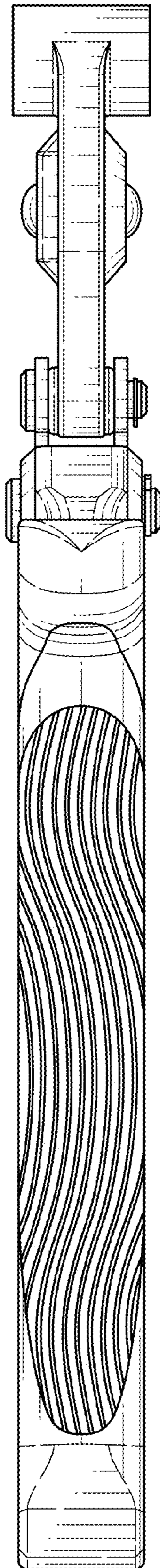

FIG. 4

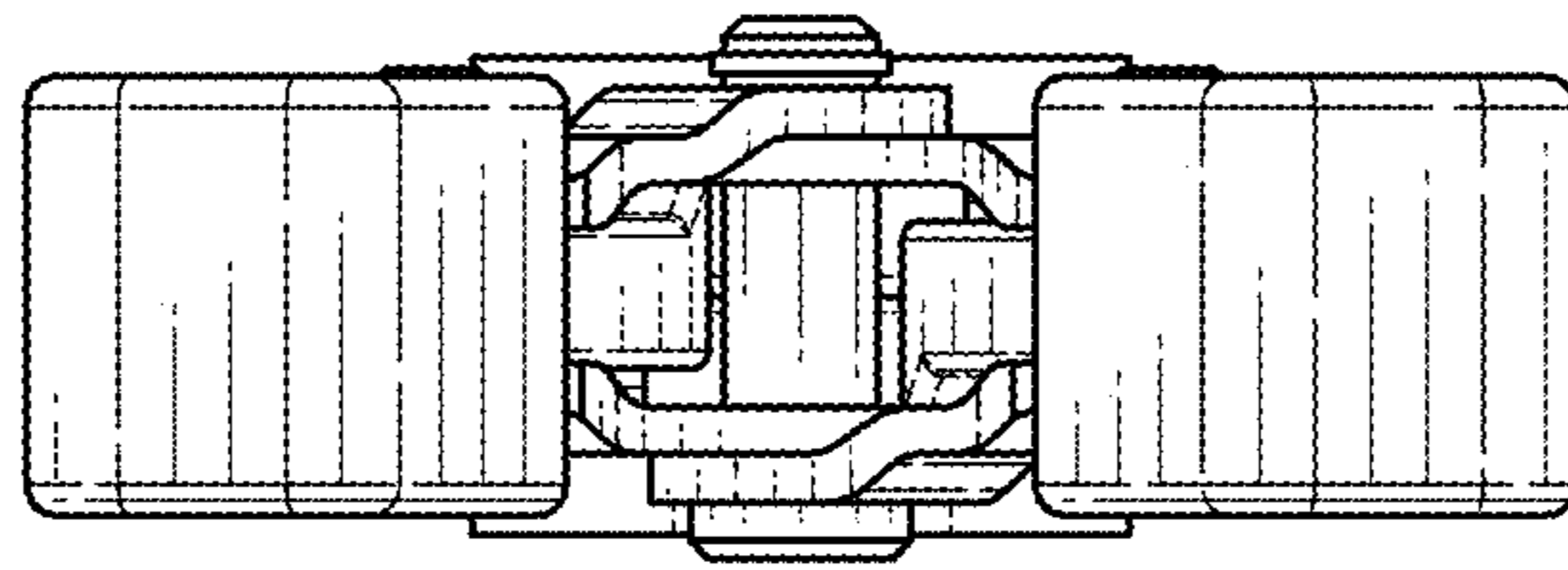

FIG. 5

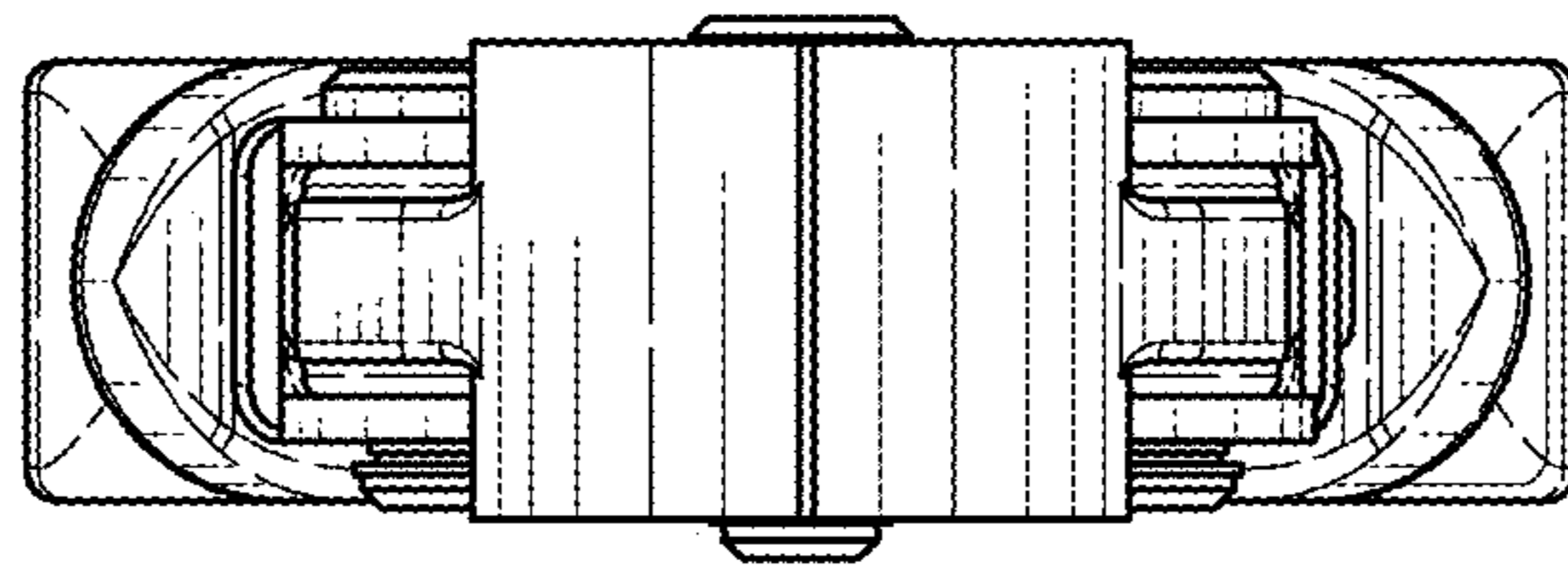

FIG. 6



FIG. 7