



US00D900557S

(12) **United States Design Patent** (10) **Patent No.:** **US D900,557 S**
LaPierre (45) **Date of Patent:** **** Nov. 3, 2020**

- (54) **PORTABLE HOLDER FOR A CONCAVE CONTAINER**
- (71) Applicant: **Seth Charles LaPierre**, Arlington, VA (US)
- (72) Inventor: **Seth Charles LaPierre**, Arlington, VA (US)
- (73) Assignee: **Seth C. LaPierre**, Arlington, VA (US)
- (**) Term: **15 Years**
- (21) Appl. No.: **29/662,618**
- (22) Filed: **Sep. 6, 2018**

(56) **References Cited**

U.S. PATENT DOCUMENTS

3,698,675 A *	10/1972	Lerew	A47K 1/09	248/311.2
D228,335 S *	9/1973	Jackson	D7/620	
5,224,678 A *	7/1993	McClellan	B65D 21/0224	108/53.1
5,279,452 A *	1/1994	Huynh	B60N 3/103	108/46
D370,384 S *	6/1996	Shamis	D7/393	
D709,738 S *	7/2014	Weinert	D7/622	
D725,971 S *	4/2015	Farhat	D7/622	
D795,021 S *	8/2017	Lindloff	D7/620	
2002/0145096 A1 *	10/2002	Eubanks	A47G 23/0225	248/311.2

* cited by examiner

Primary Examiner — Terry A Wallace

- Related U.S. Application Data**
- (63) Continuation of application No. 29/662,614, filed on Sep. 6, 2018.
 - (51) **LOC (12) Cl.** **07-06**
 - (52) **U.S. Cl.**
USPC **D7/620**
 - (58) **Field of Classification Search**
USPC D7/619.1-625, 605-608, 707-708, 533, D7/536, 393, 396.2
CPC A47G 23/0266; A47G 23/0233; A47G 23/0241; A47G 23/0216; A47G 23/02; A47G 23/0225; A47G 19/2205; B65D 25/2829; B65D 25/2817; B65D 2313/02; B65D 21/0224; A45F 5/10; A47J 45/10; A47J 45/077; A47C 7/622; A47C 4/20; B60N 3/102; B60N 3/103; B60N 3/106; B60N 3/108; B62B 9/26; A45C 11/20; A47K 1/09

See application file for complete search history.

(57) **CLAIM**

The ornamental design of a portable holder for a concave container, substantially shown and described.

DESCRIPTION

FIG. 1 is a front perspective view of a portable holder for a concave container in accordance with the present invention; FIG. 2 is a front view of the portable holder for a concave container in FIG. 1; FIG. 3 is a rear view thereof; FIG. 4 is a left side view thereof; FIG. 5 is a right side view thereof; FIG. 6 is a top view thereof; and, FIG. 7 is a bottom view thereof. The broken lines are for illustrative purposes only and form no part of the claimed design.

1 Claim, 4 Drawing Sheets

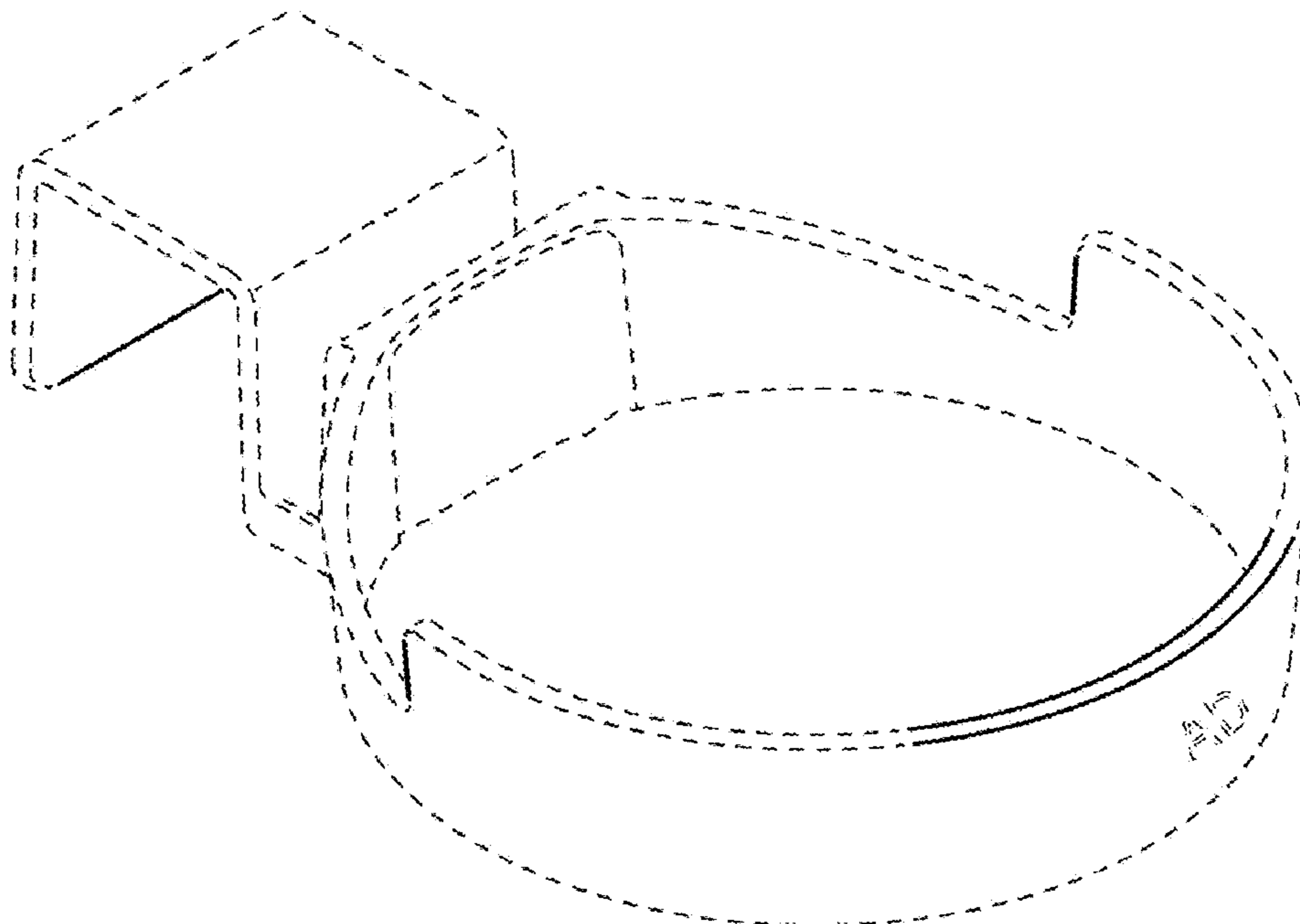

FIG. 1

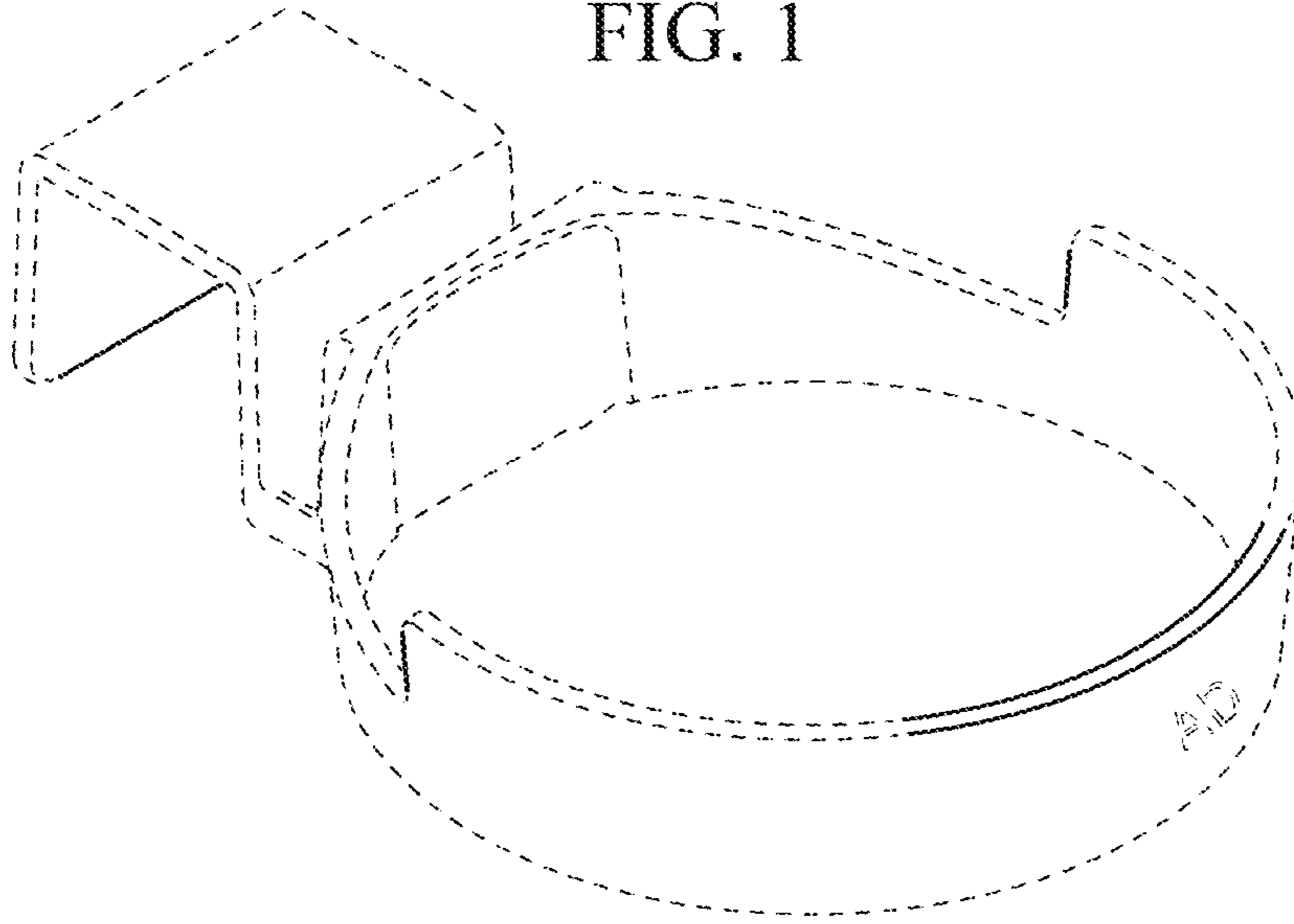

FIG. 2

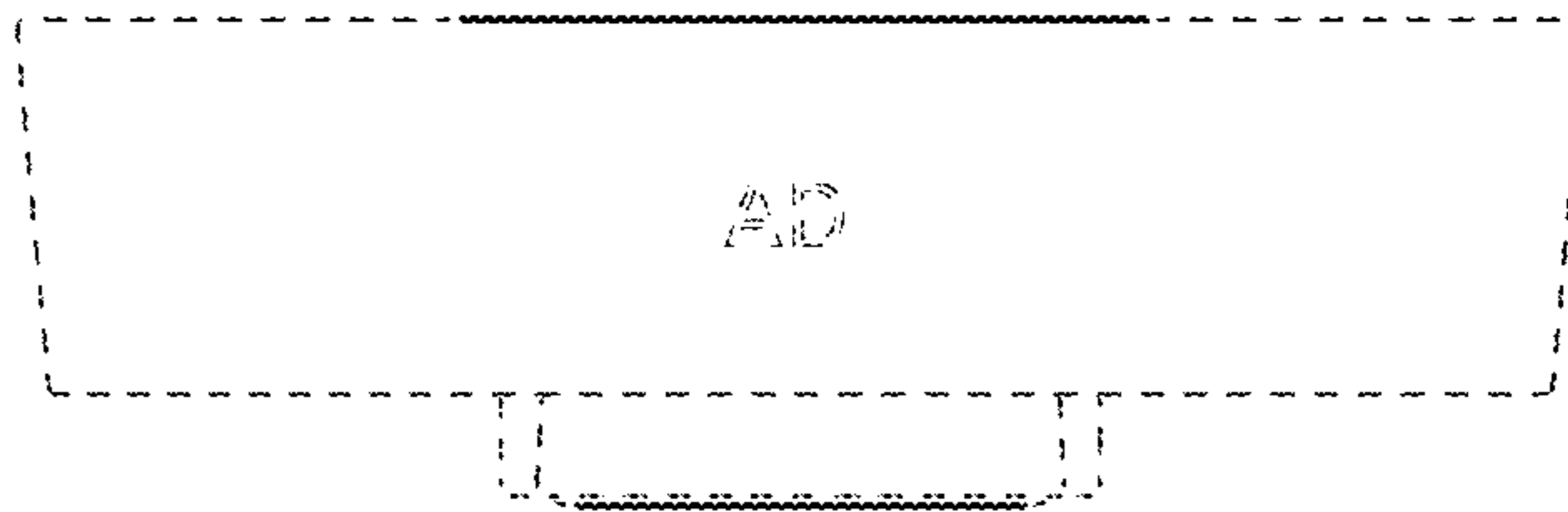

FIG. 3

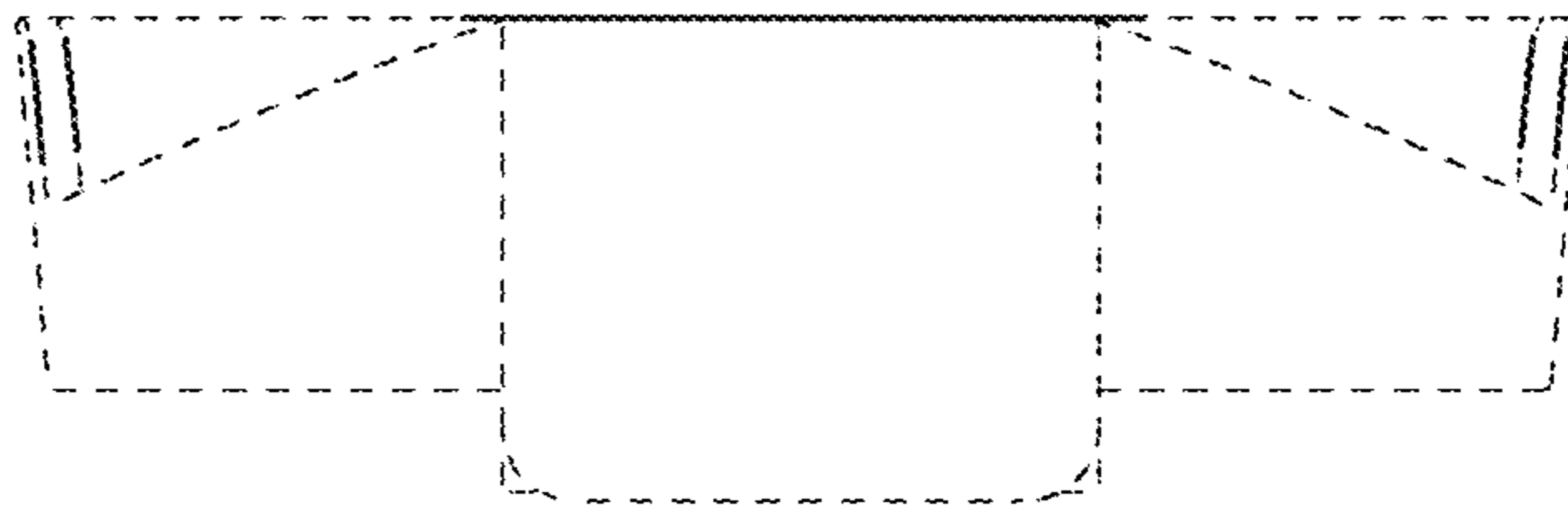

FIG. 4

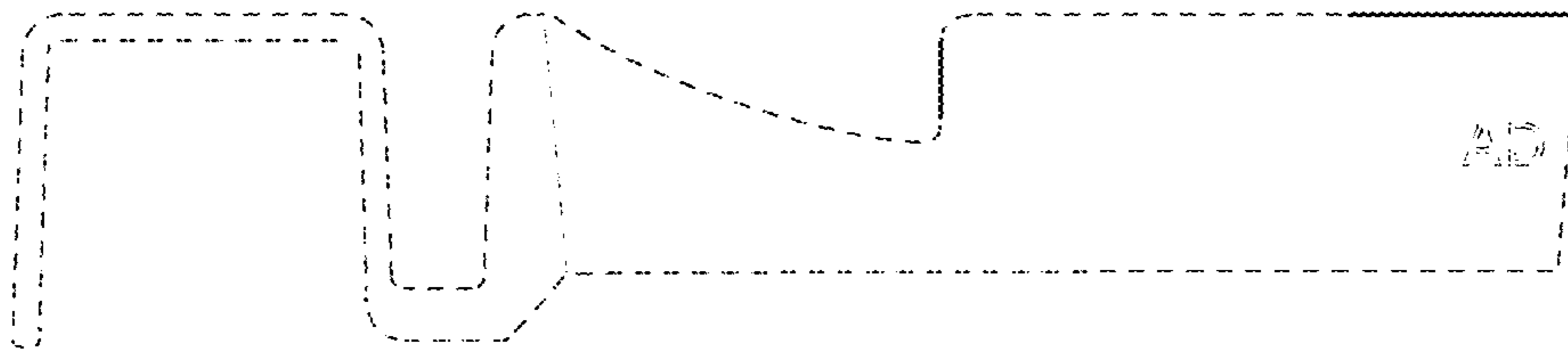

FIG. 5

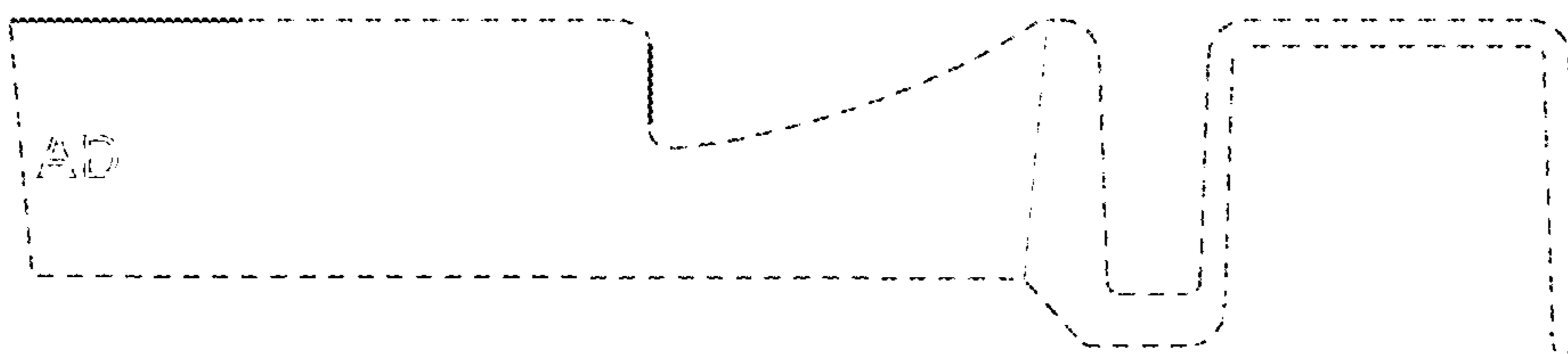

FIG. 6

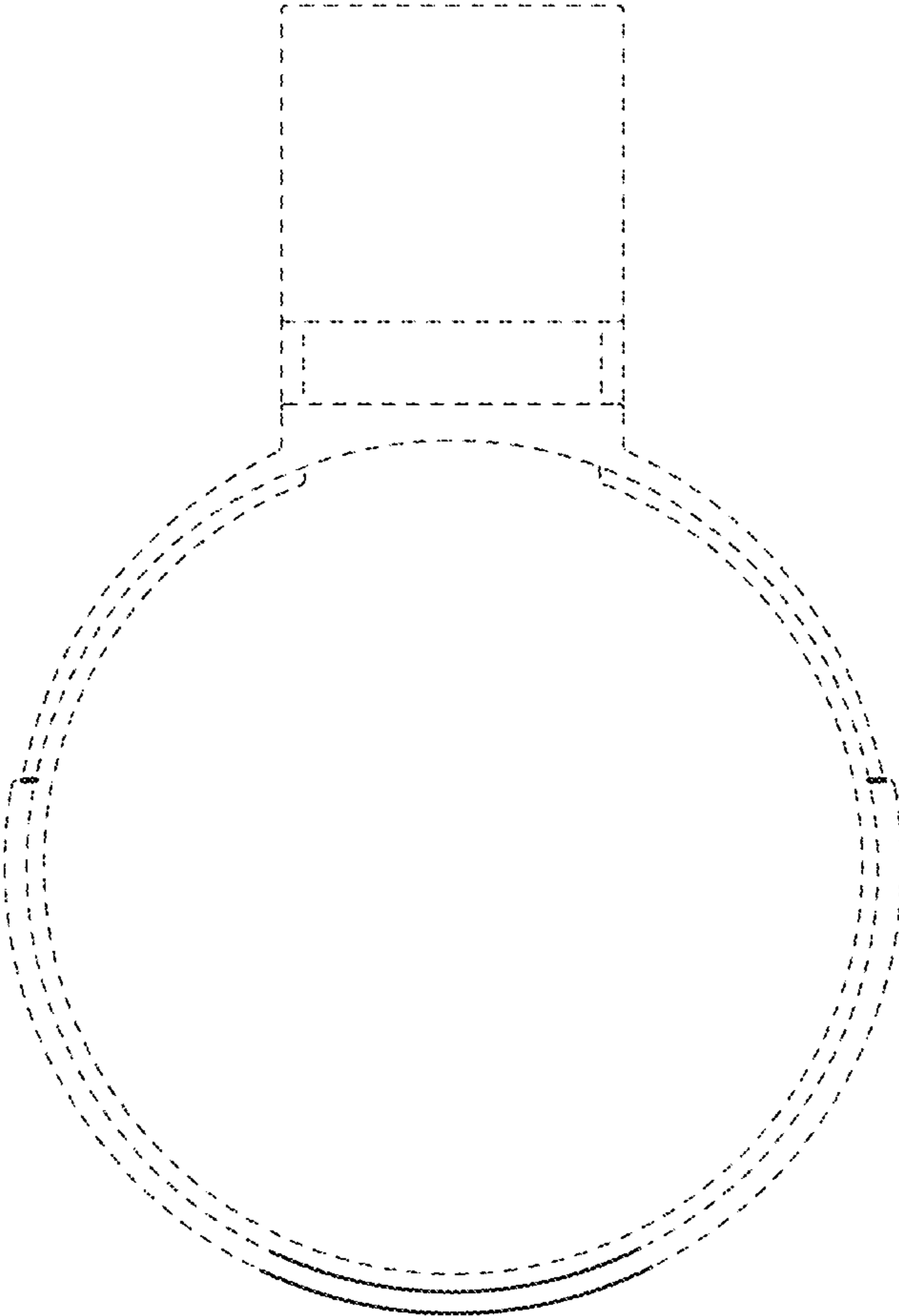

FIG. 7

