



US00D900521S

(12) **United States Design Patent**  
**Kim et al.**

(10) **Patent No.:** **US D900,521 S**

(45) **Date of Patent:** **\*\* Nov. 3, 2020**

(54) **COMPACT KITCHEN UNIT**

(71) Applicant: **LG ELECTRONICS INC.**, Seoul (KR)

(72) Inventors: **Hyungki Kim**, Seoul (KR); **Wonsang Choi**, Seoul (KR); **Hyun Choi**, Seoul (KR); **Sookyung Kang**, Seoul (KR); **Kyukwan Choi**, Seoul (KR)

(73) Assignee: **LG ELECTRONICS INC.**, Seoul (KR)

(\*\*) Term: **15 Years**

(21) Appl. No.: **35/507,218**

(22) Filed: **Nov. 22, 2018**

(80) **Hague Agreement Data**

Int. Filing Date: **Nov. 22, 2018**

Int. Reg. No.: **DM/202171**

Int. Reg. Date: **Nov. 22, 2018**

Int. Reg. Pub. Date: **Aug. 9, 2019**

(30) **Foreign Application Priority Data**

May 23, 2018 (KR) ..... 30-2018-0023941

(51) **LOC (12) Cl.** ..... **06-06**

(52) **U.S. Cl.**  
USPC ..... **D6/702; D6/703; D6/705**

(58) **Field of Classification Search**  
USPC ..... D6/663, 668.1, 668.2, 671, 371.2, 698,  
D6/699, 699.2, 702, 703, 704, 705  
(Continued)

(56) **References Cited**

**U.S. PATENT DOCUMENTS**

D127,588 S \* 6/1941 Owen ..... D6/657

D154,419 S \* 7/1949 Mushta ..... D6/667

(Continued)

*Primary Examiner* — Mary Ann Calabrese

(74) *Attorney, Agent, or Firm* — Birch, Stewart, Kolasch & Birch, LLP

(57) **CLAIM**

The ornamental design for compact kitchen unit, as shown and described.

**DESCRIPTION**

1. Compact kitchen unit
- 1.1 is a perspective view with the door open.
- 1.2 is a front view with the door open.
- 1.3 is a rear view.
- 1.4 is a left side view with the door open.
- 1.5 is a right side view with the door open.
- 1.6 is a top view with the door open.
- 1.7 is a bottom view with the door open.
- 1.8 is a perspective view with the door closed.
- 1.9 is a perspective view with the door open and the upper shelf extended.
- 1.10 is a front view with the door open and the upper shelf extended.
- 1.11 is a rear view.
- 1.12 is a left side view with the door open and the upper shelf extended.
- 1.13 is a right side view with the door open and the upper shelf extended.
- 1.14 is a top view with the door open and the upper shelf extended.
- 1.15 is a bottom view with the door open and the upper shelf extended.
- 1.16 is a perspective view with the door open and the lower shelf extended.
- 1.17 is a front view with the door open and the lower shelf extended.
- 1.18 is a rear view.
- 1.19 is a left side view with the door open and the lower shelf extended.
- 1.20 is a right side view.
- 1.21 is a top view with the door open and the lower shelf extended.
- 1.22 is a bottom view with the door open and the lower shelf extended.

(Continued)

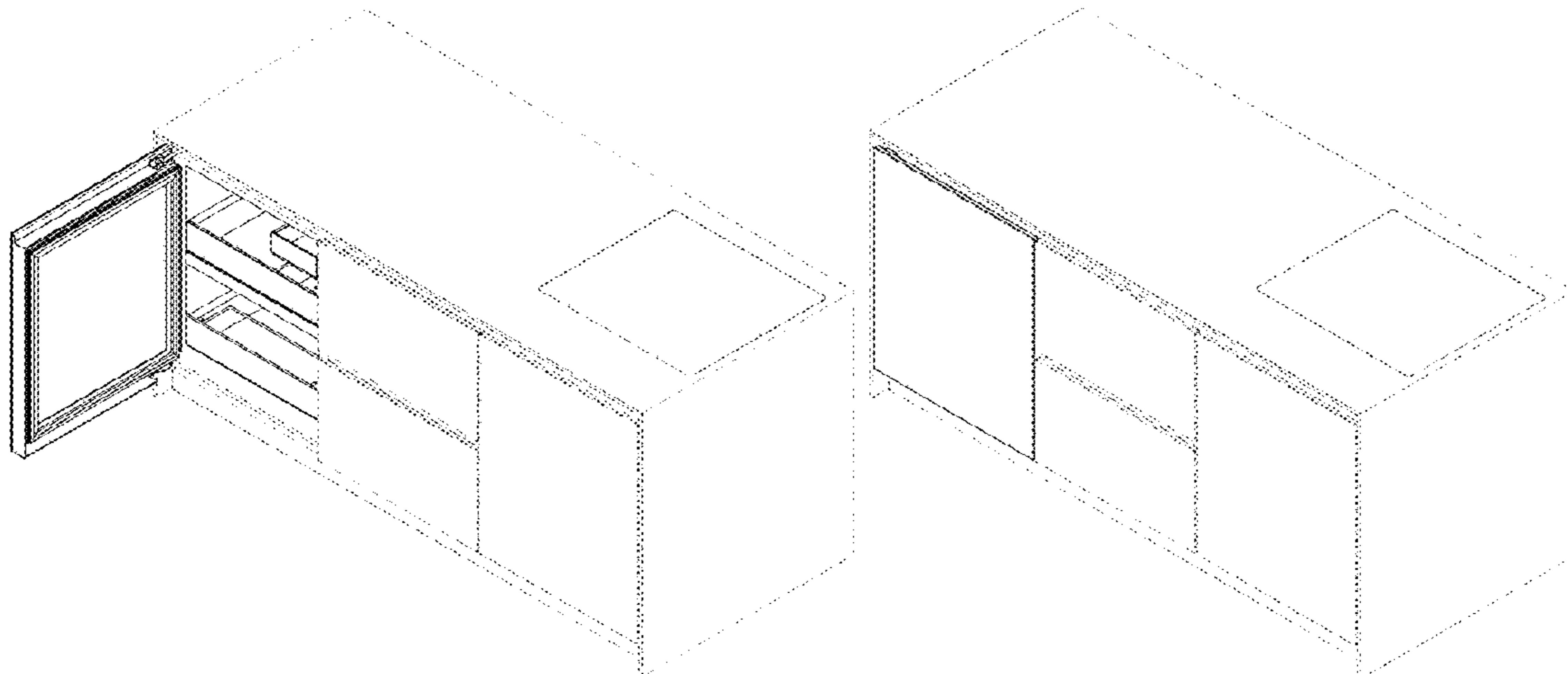

The broken lines indicate portions of the article that form no part of the claimed design.

**1 Claim, 22 Drawing Sheets**

**(58) Field of Classification Search**

CPC ..... A47B 37/00; A47B 53/00; A47B 53/02;  
 A47B 55/00; A47B 71/00; A47B 77/00;  
 A47B 88/00; A47B 88/40; A47B 96/00;  
 A47F 3/00; A47F 3/0404; A47F 3/043

See application file for complete search history.

**(56) References Cited**

U.S. PATENT DOCUMENTS

D214,925 S \* 8/1969 Provest ..... D6/667  
 D248,975 S \* 8/1978 Cole ..... D6/663  
 D325,478 S \* 4/1992 Ward ..... D6/671.1  
 D401,478 S \* 11/1998 Greenway ..... D7/601  
 D421,685 S \* 3/2000 Carrabba ..... D6/663  
 D434,579 S \* 12/2000 Rabb ..... D6/663  
 D437,148 S \* 2/2001 Base ..... D27/189  
 D610,829 S \* 3/2010 Nelsen ..... D6/664

D610,848 S \* 3/2010 Yang ..... F21V 23/0471  
 D6/705  
 D618,258 S \* 6/2010 Chen ..... F25D 23/069  
 D15/81  
 D715,335 S \* 10/2014 Kim ..... D15/85  
 D735,499 S \* 8/2015 Stein ..... A47B 97/00  
 D6/663  
 D766,023 S \* 9/2016 Coretti, Jr. .... A47F 5/005  
 D6/705  
 D775,883 S \* 1/2017 Mason ..... D6/705  
 D799,252 S \* 10/2017 Coretti, Jr. .... F25D 23/069  
 D6/705  
 D799,406 S \* 10/2017 Sethapun ..... D12/345  
 D817,366 S \* 5/2018 Kim ..... D15/79  
 10,401,018 B1 \* 9/2019 Smith ..... F21V 23/0471  
 D876,491 S \* 2/2020 Yu ..... D15/79  
 2003/0066811 A1 \* 4/2003 Dimattio ..... A47F 5/005  
 211/59.2  
 2005/0093405 A1 \* 5/2005 Greiner ..... A47B 97/00  
 312/321.5  
 2013/0327064 A1 \* 12/2013 Stein ..... A47B 37/00  
 62/3.6  
 2015/0102710 A1 \* 4/2015 Hottmann ..... A47F 5/0043  
 312/128  
 2015/0296981 A1 \* 10/2015 Beauregard ..... A47B 46/00  
 312/237

\* cited by examiner

1.1

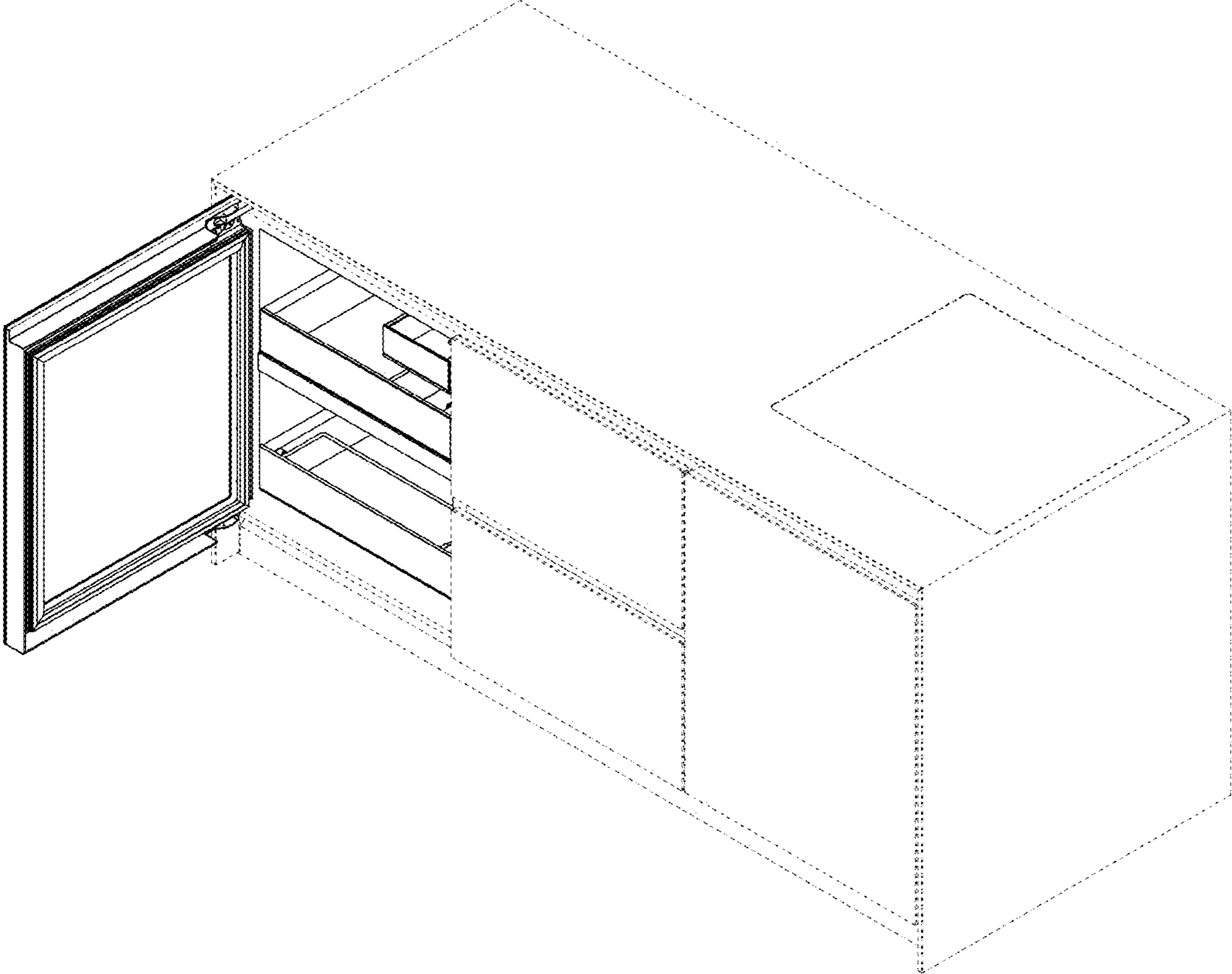

1.2

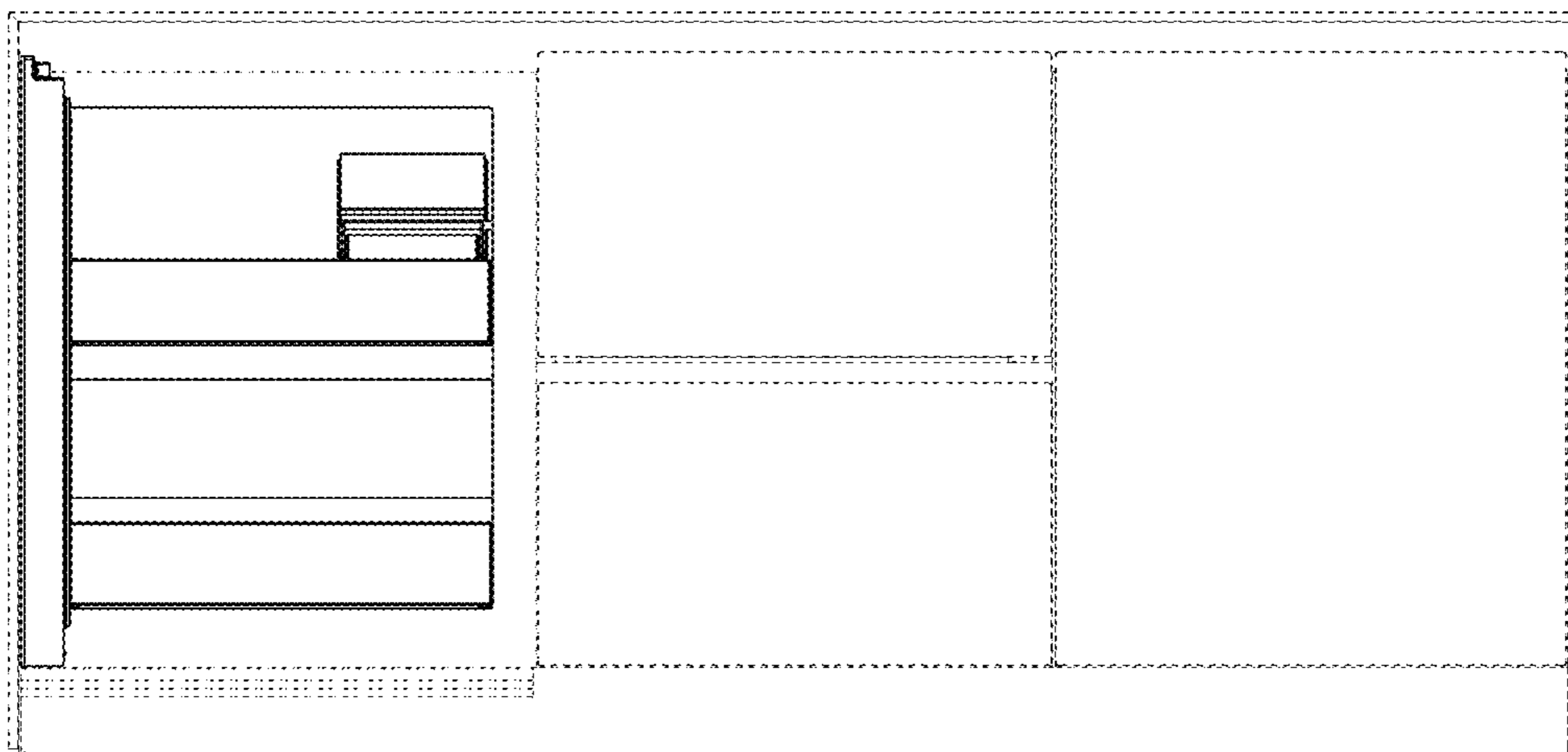

1.3

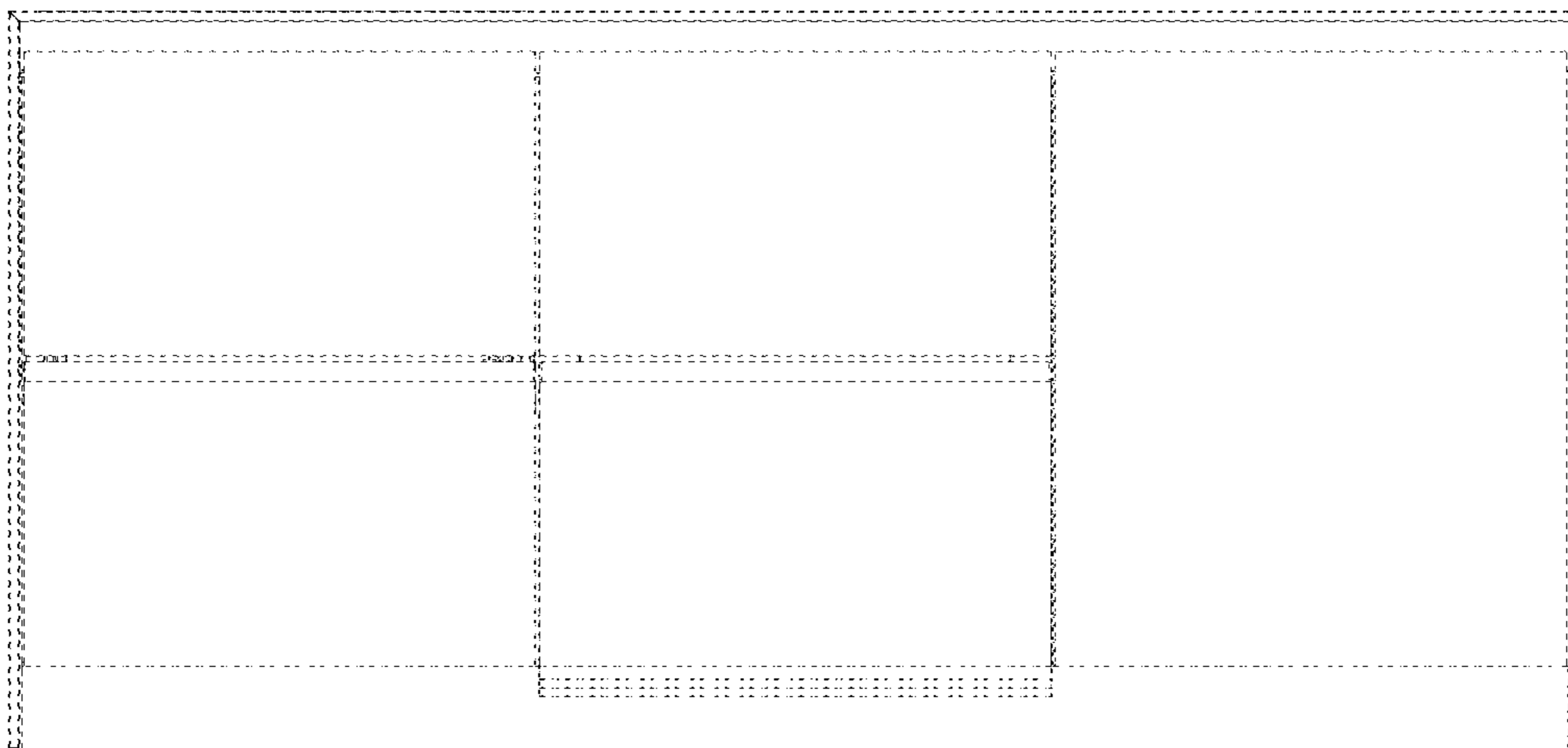

1.4

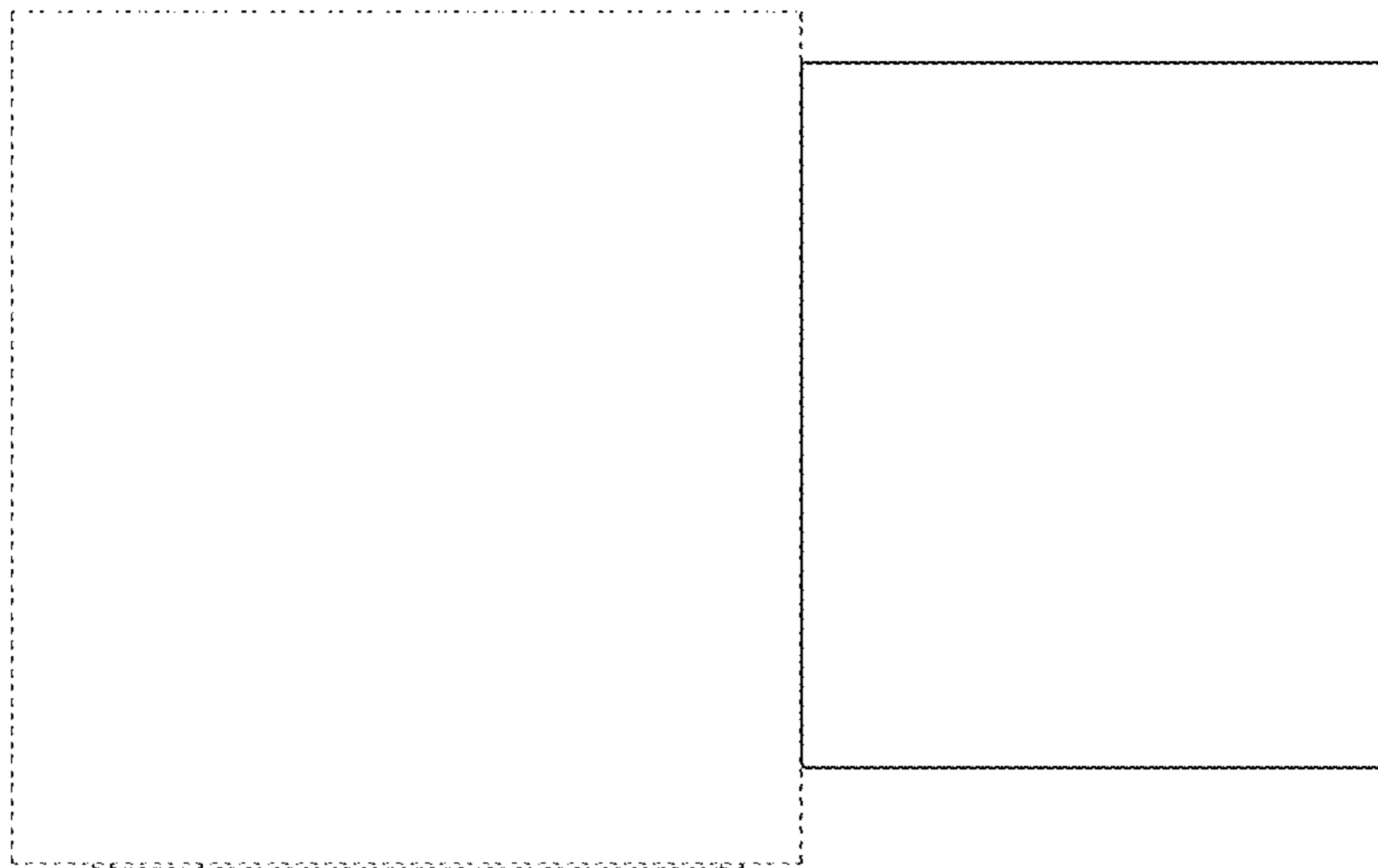

1.5

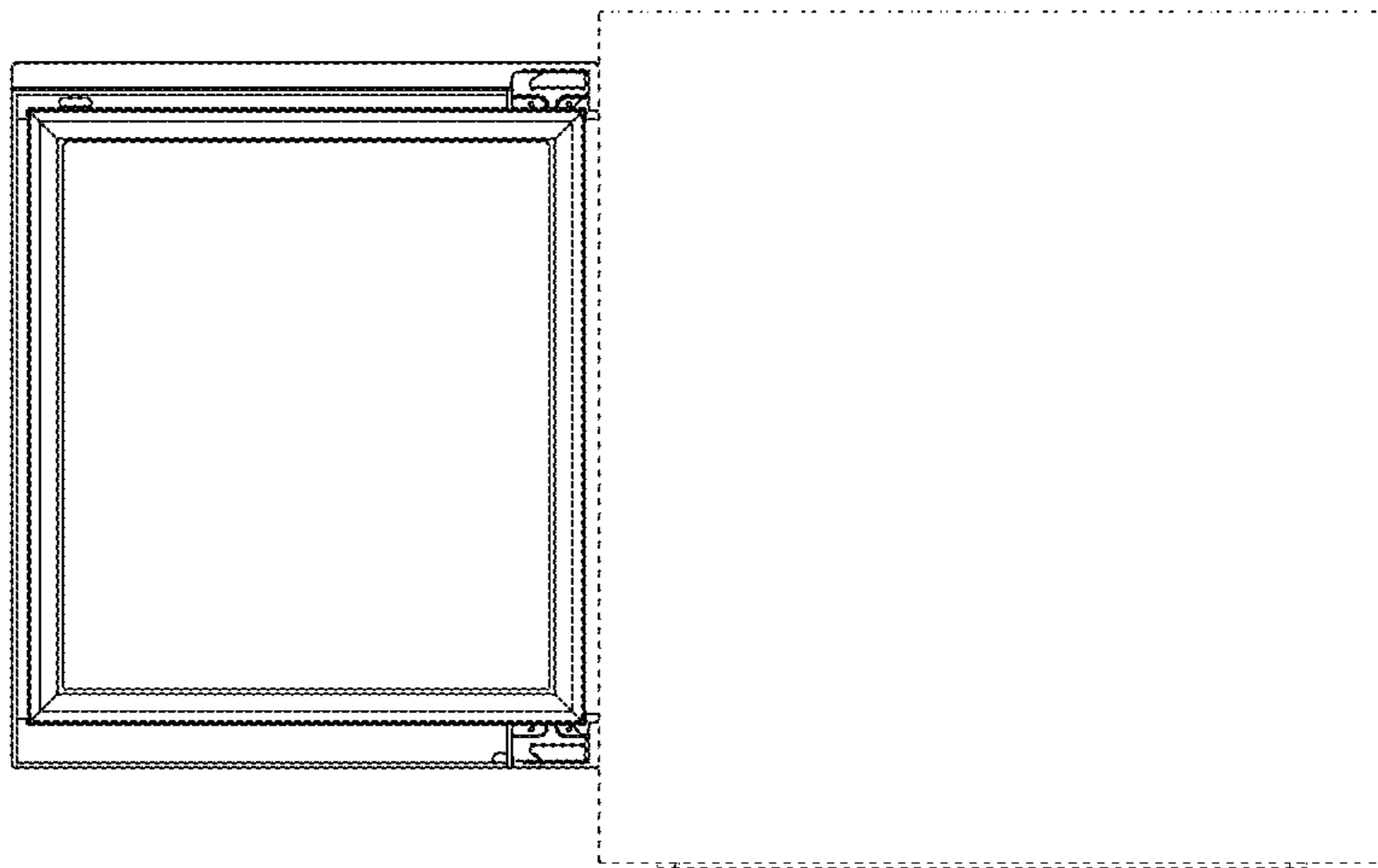

1.6

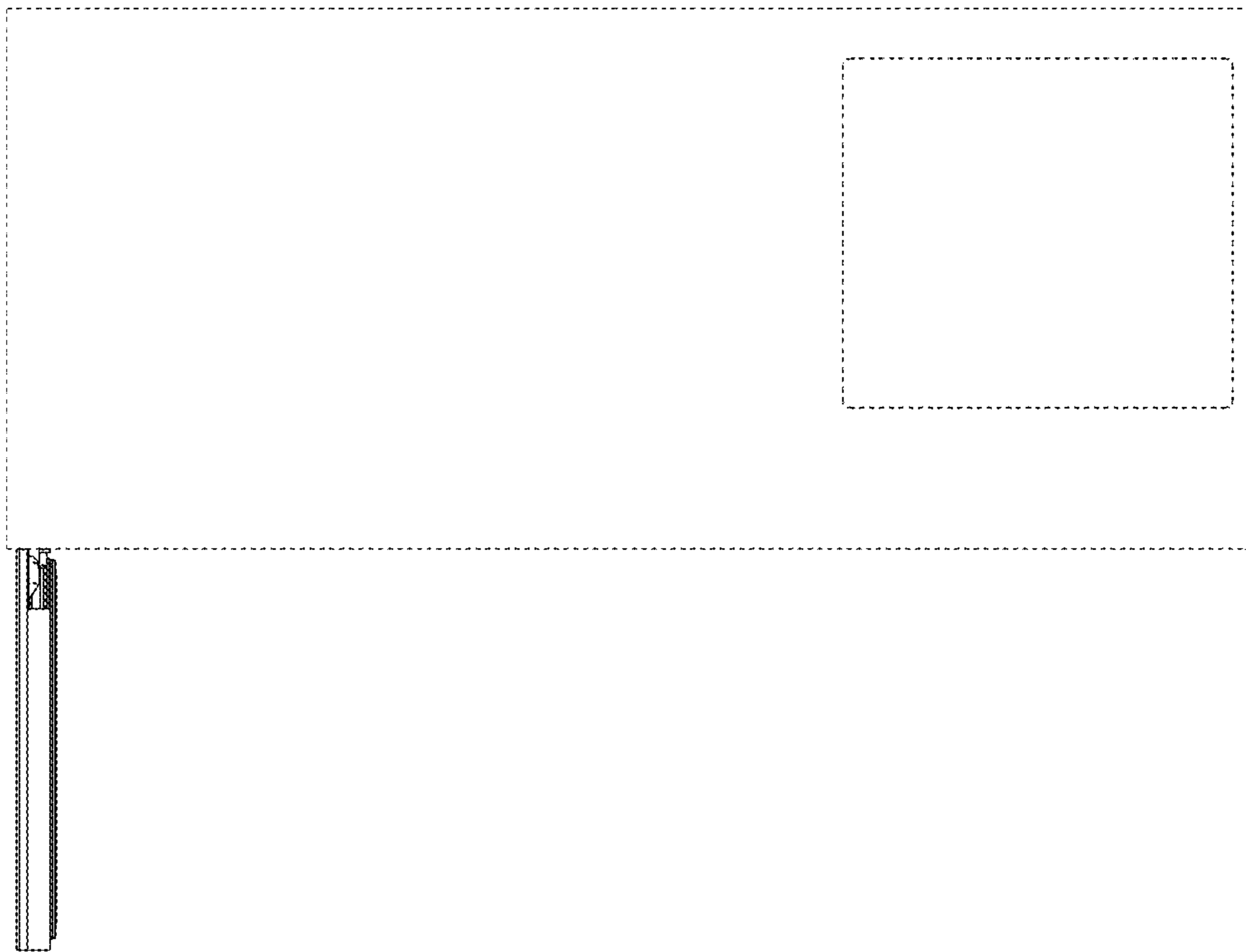



1.7

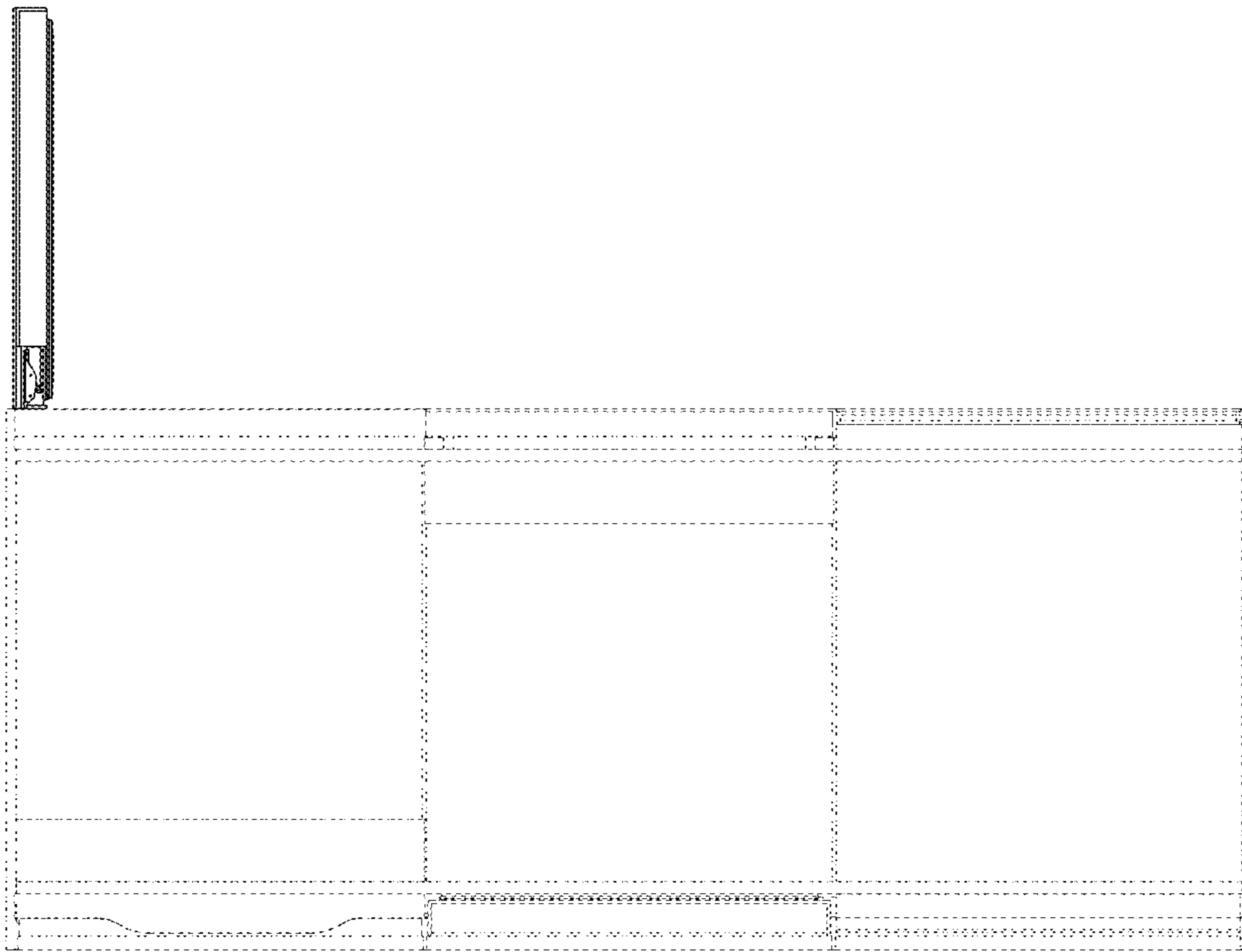

1.8

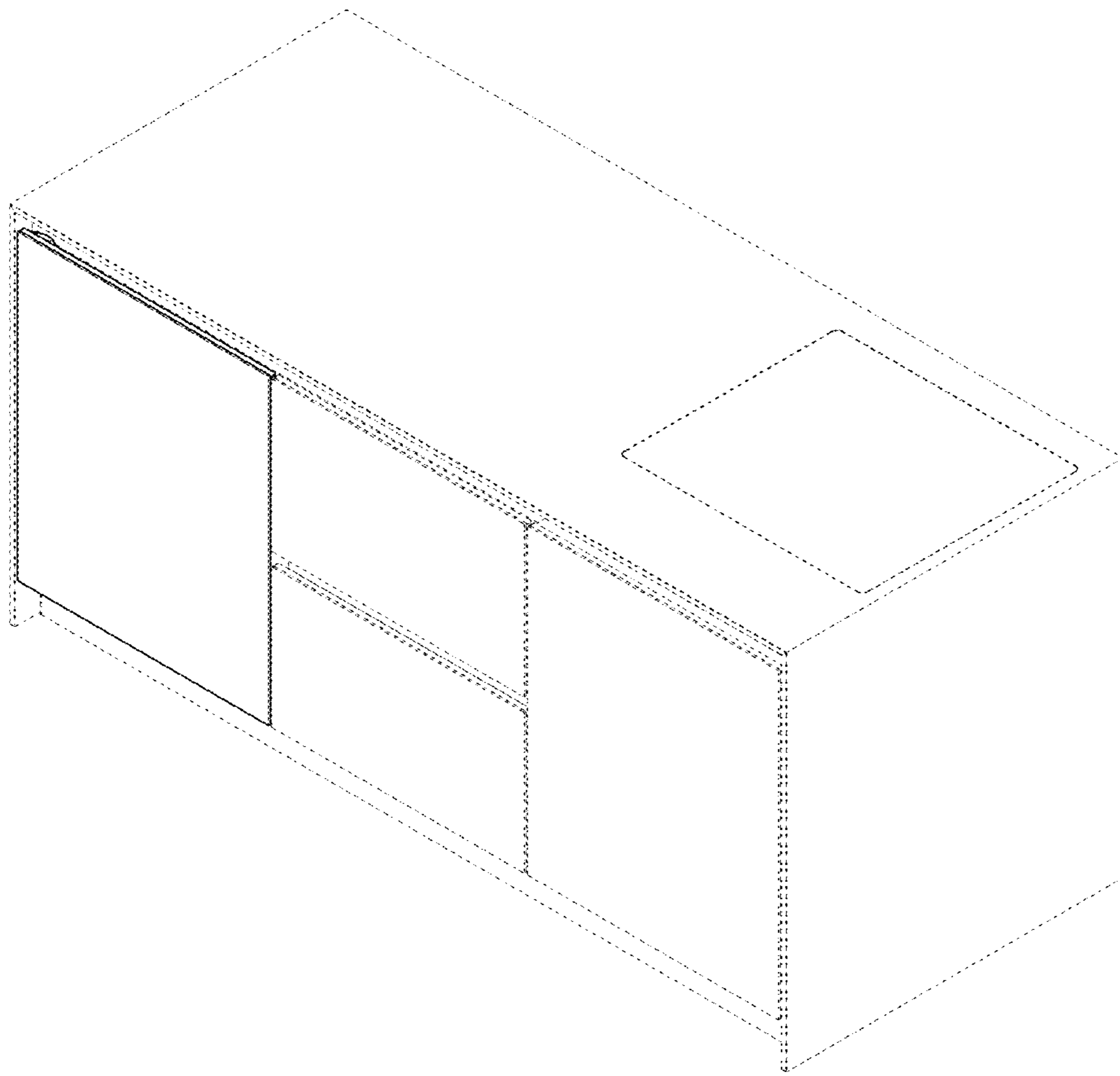

1.9

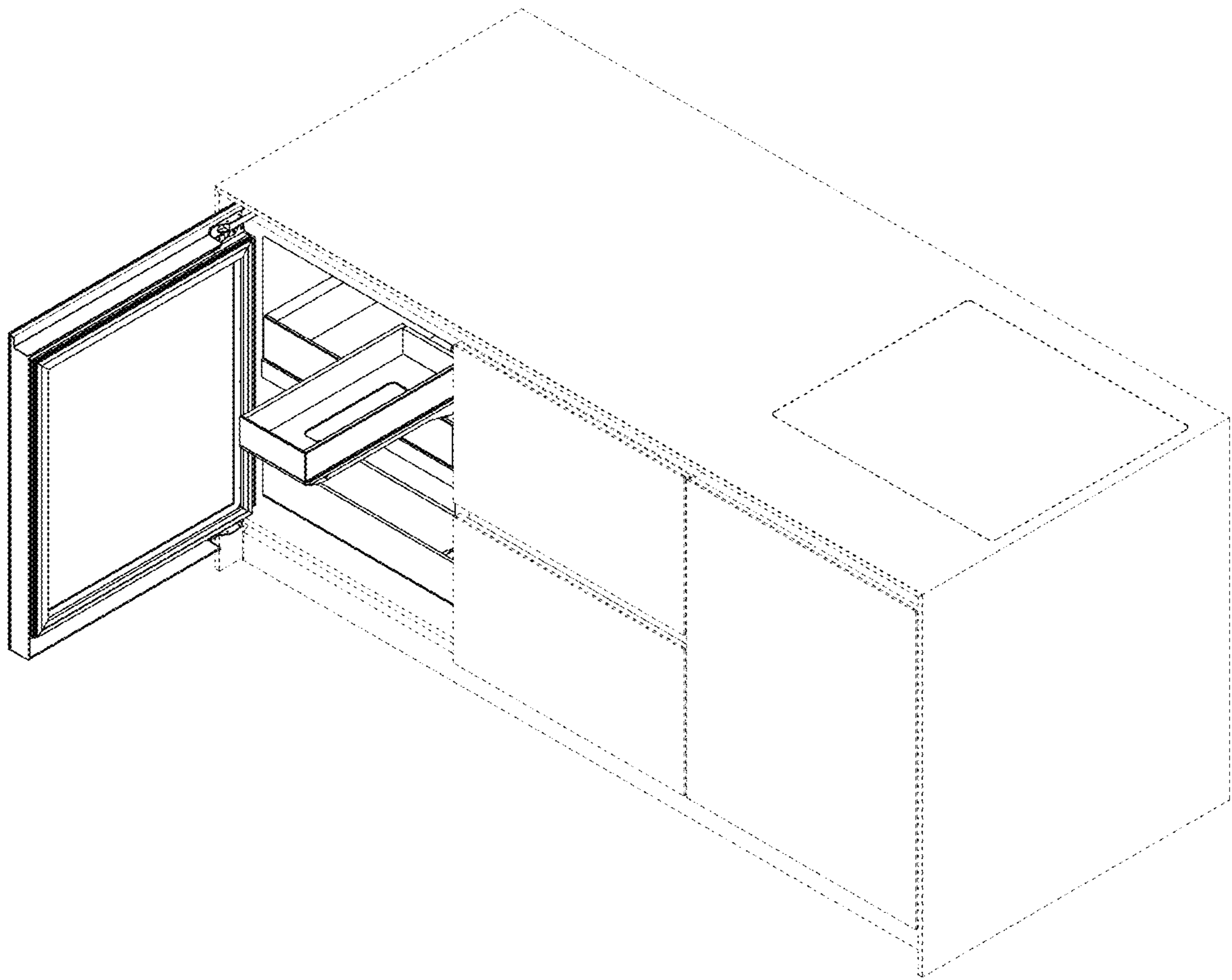

1.10

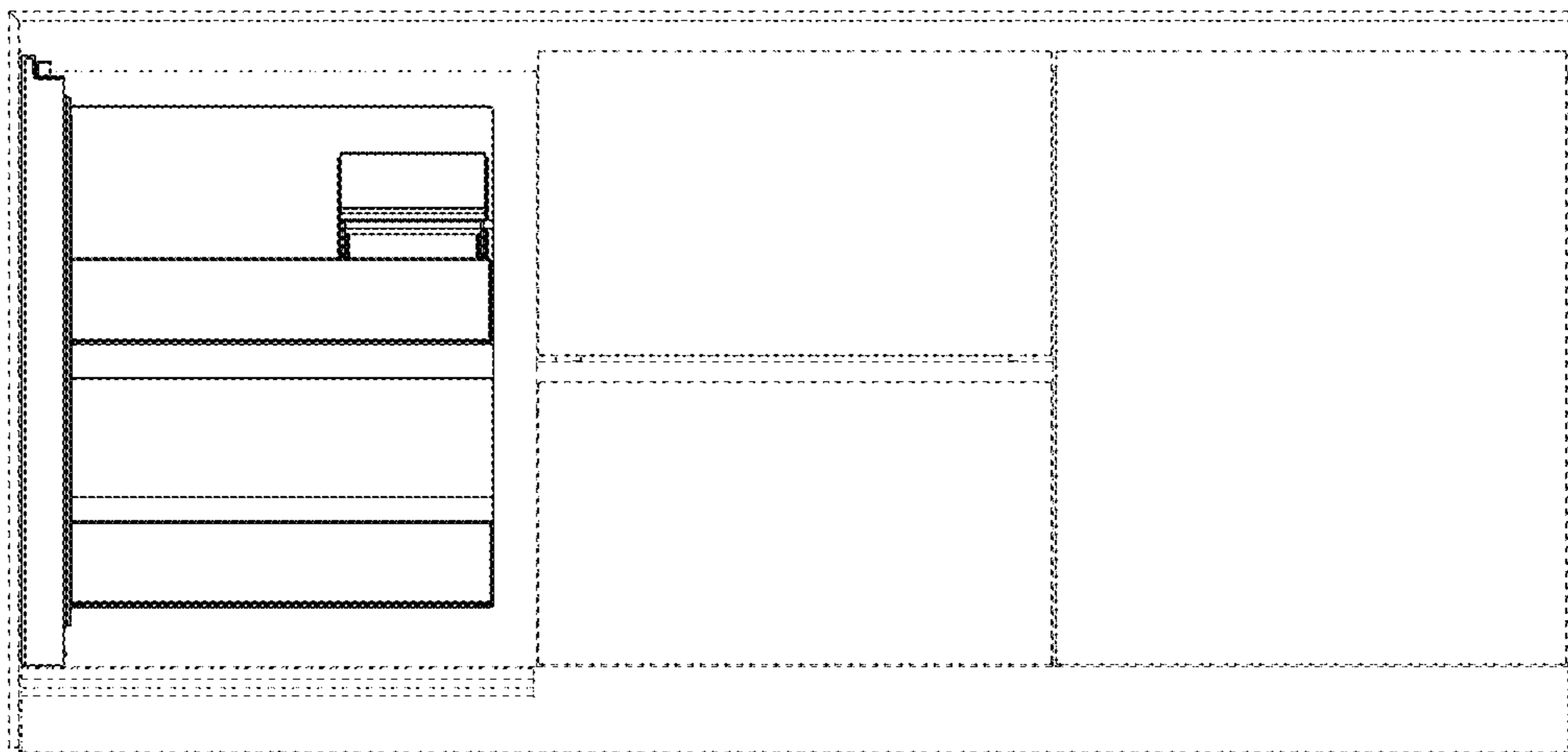

1.11

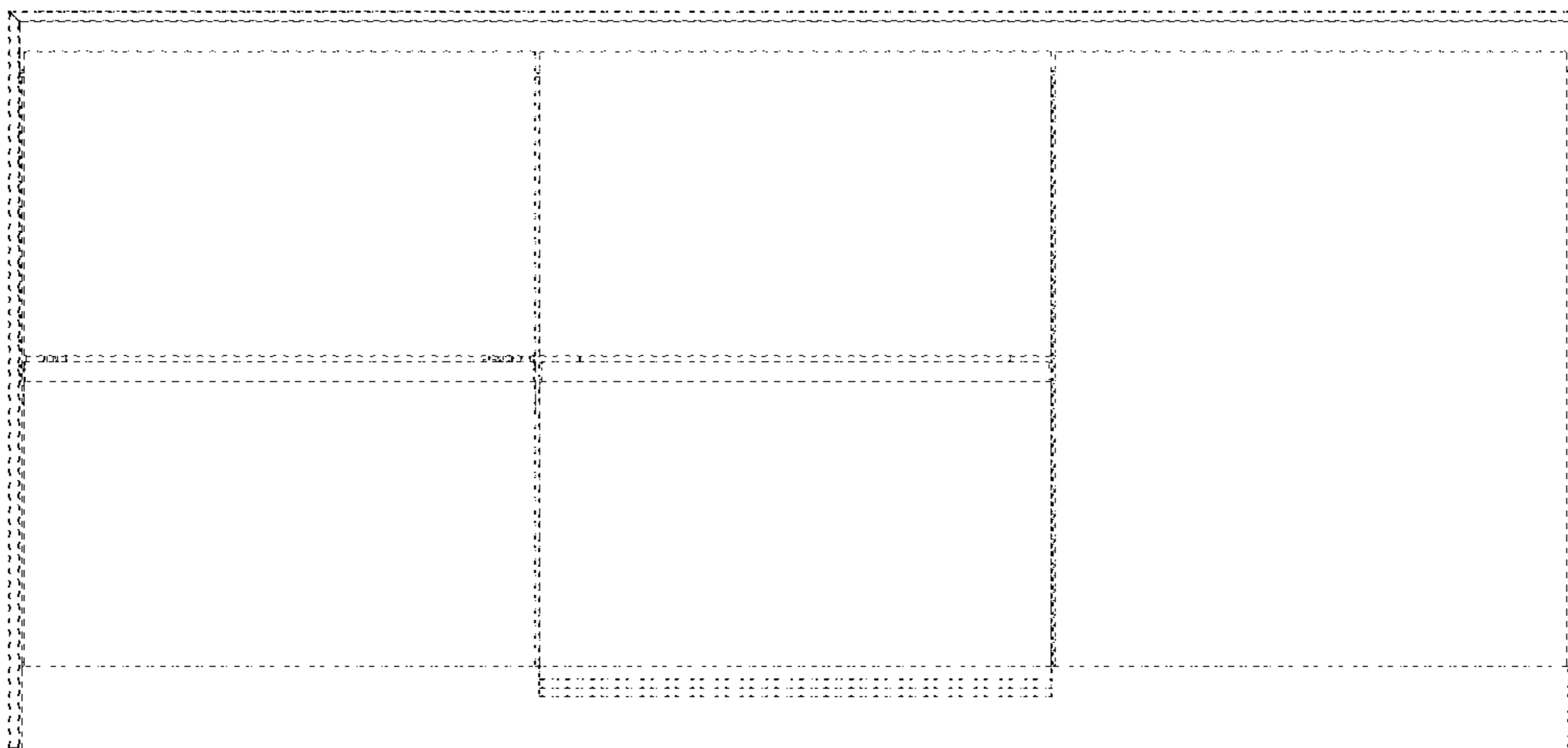

1.12

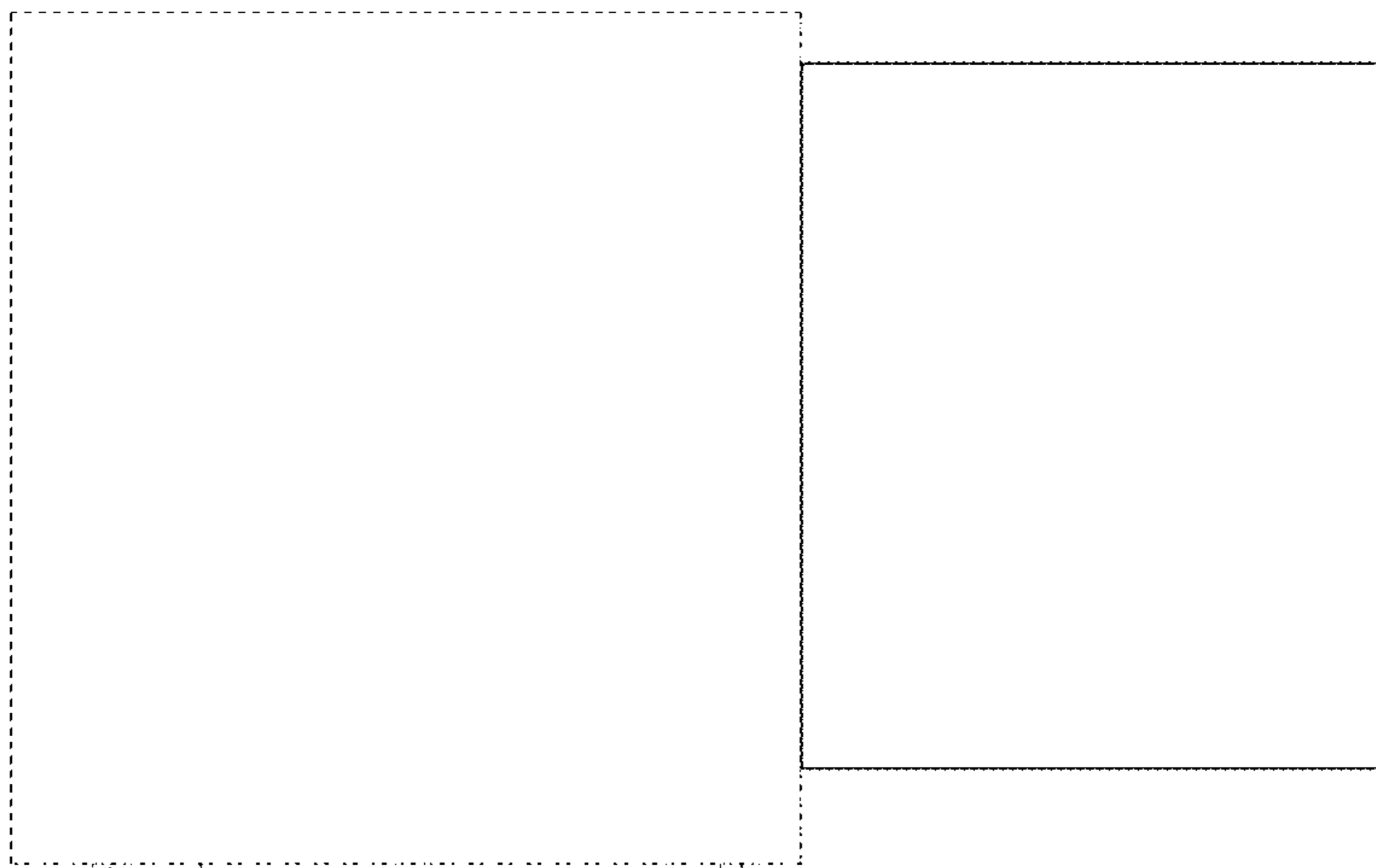

1.13

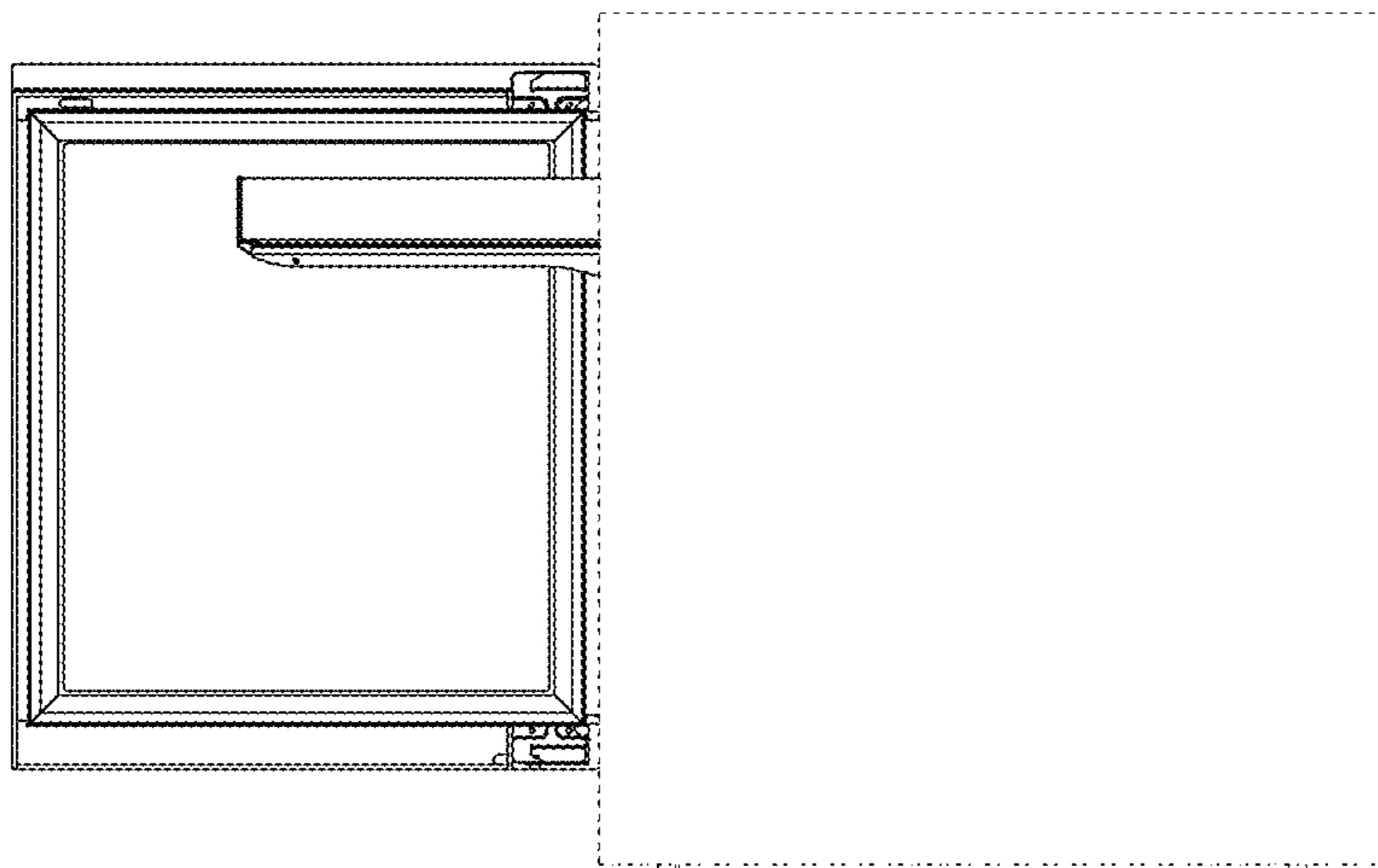

1.14

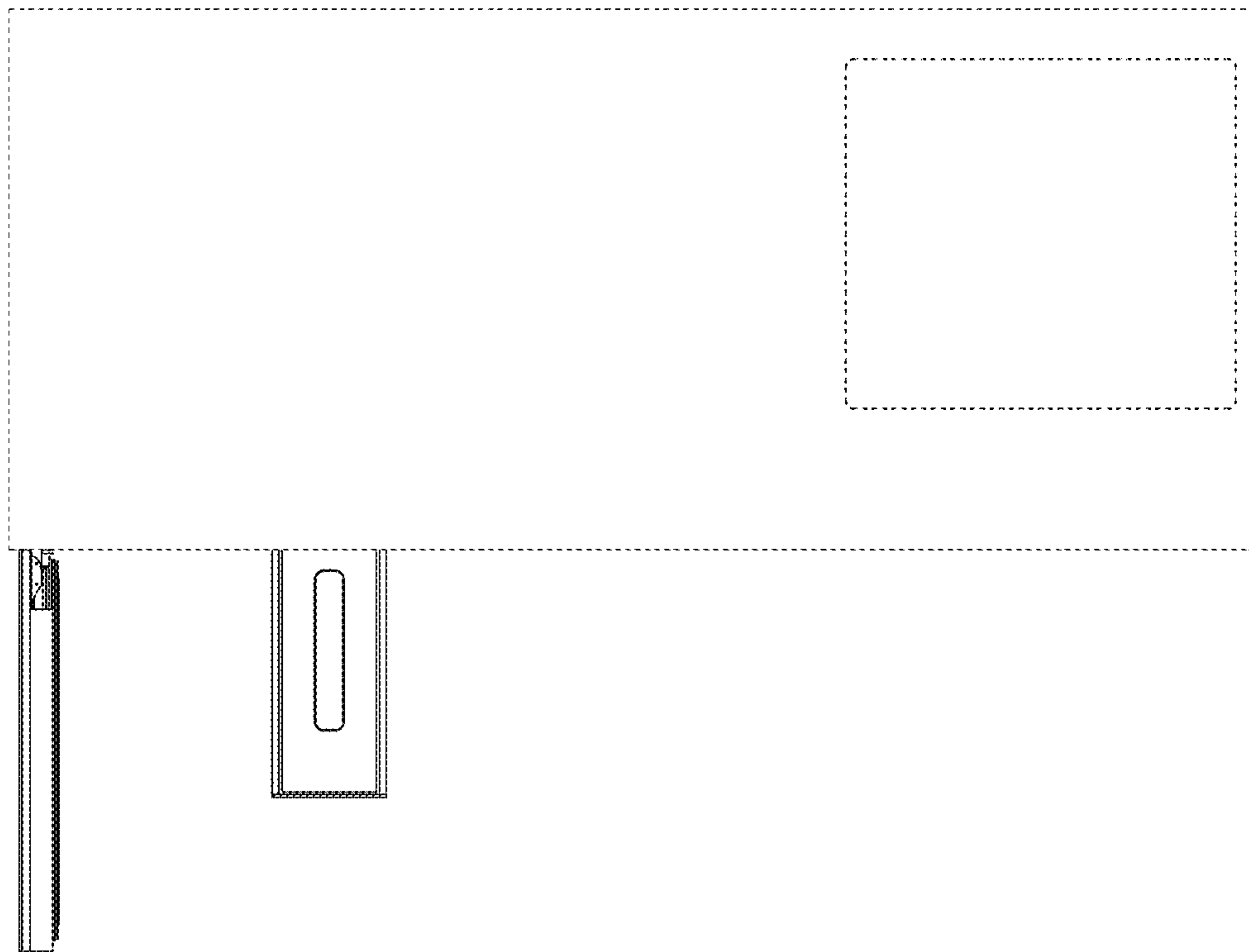



1.15

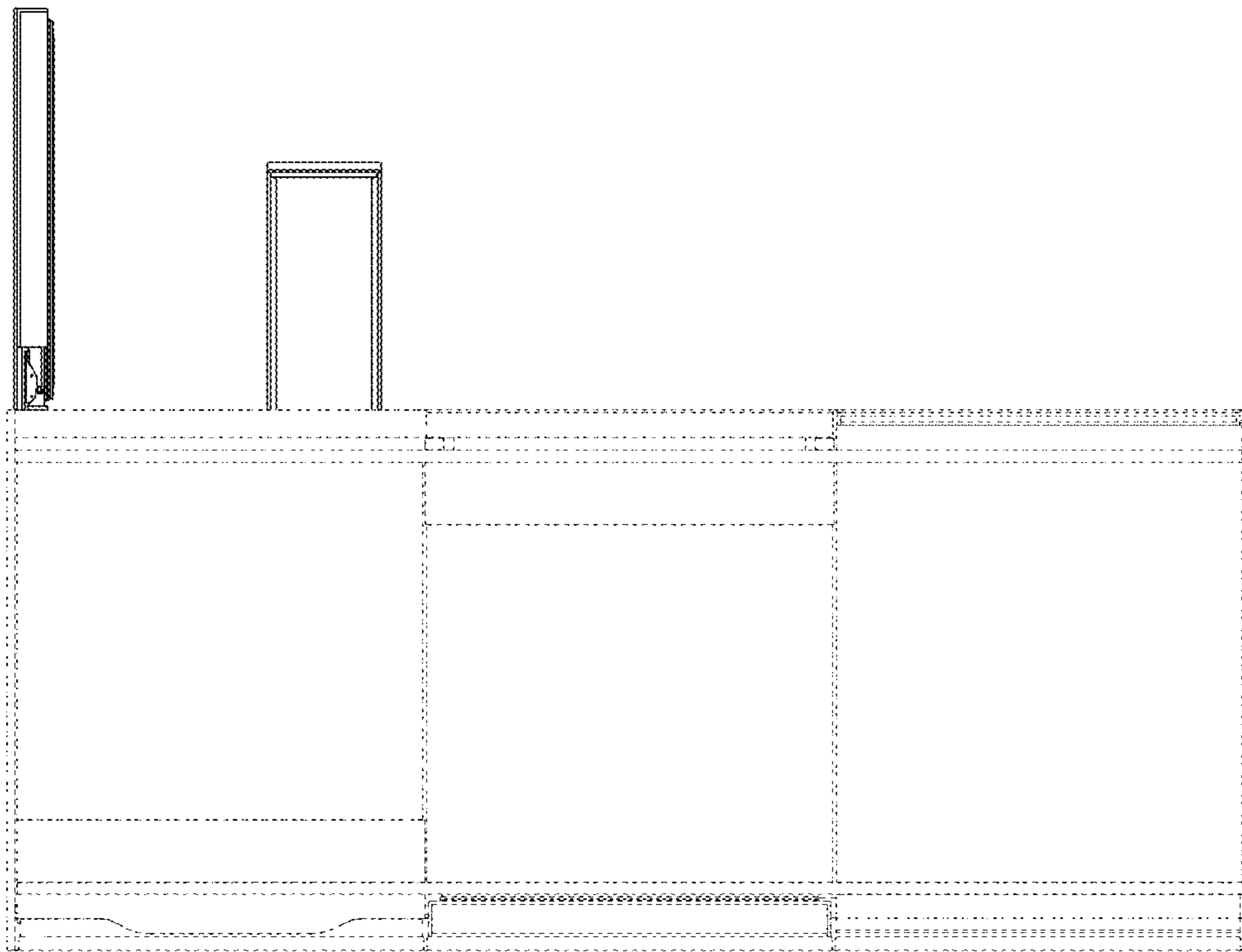

1.16

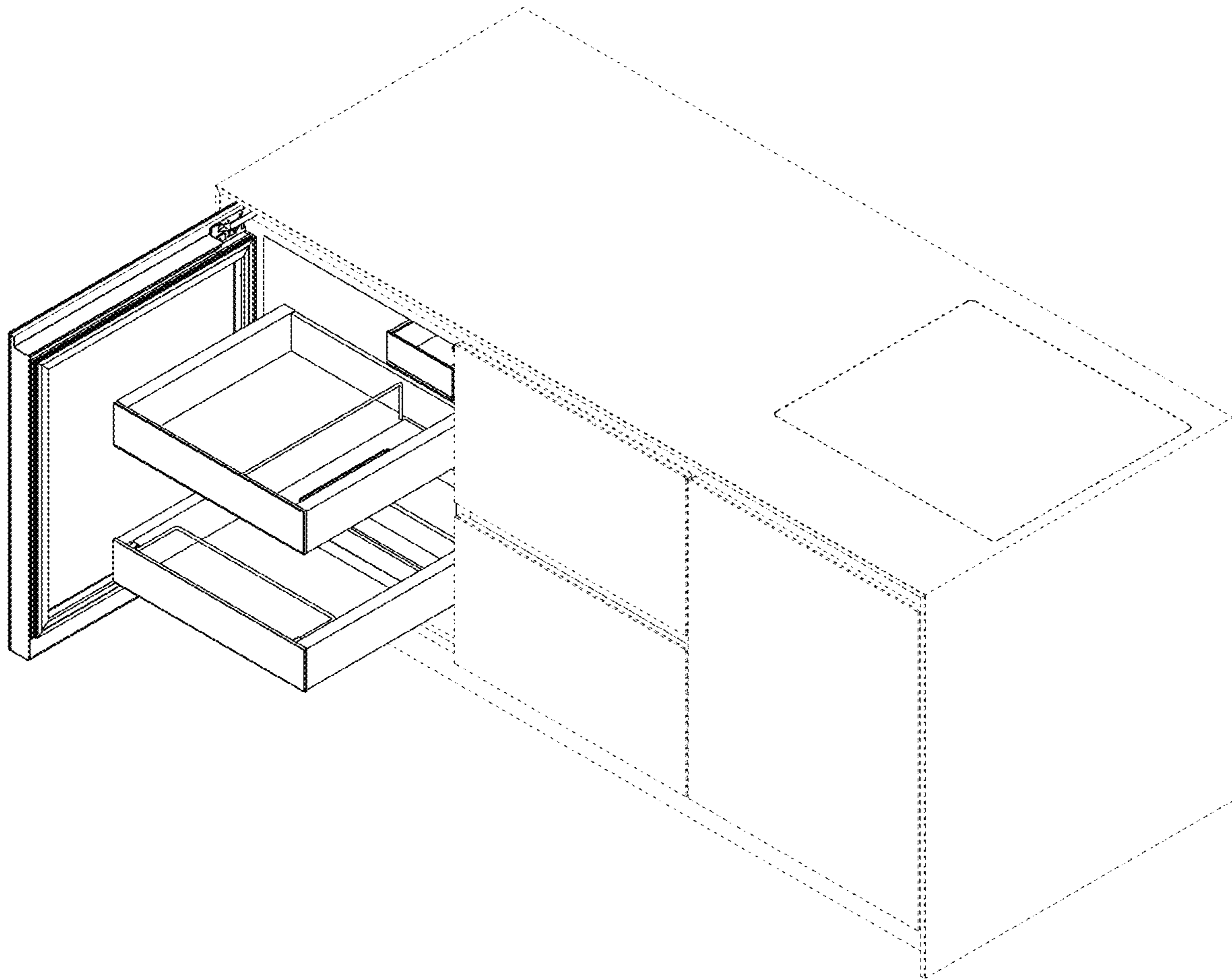

1.17

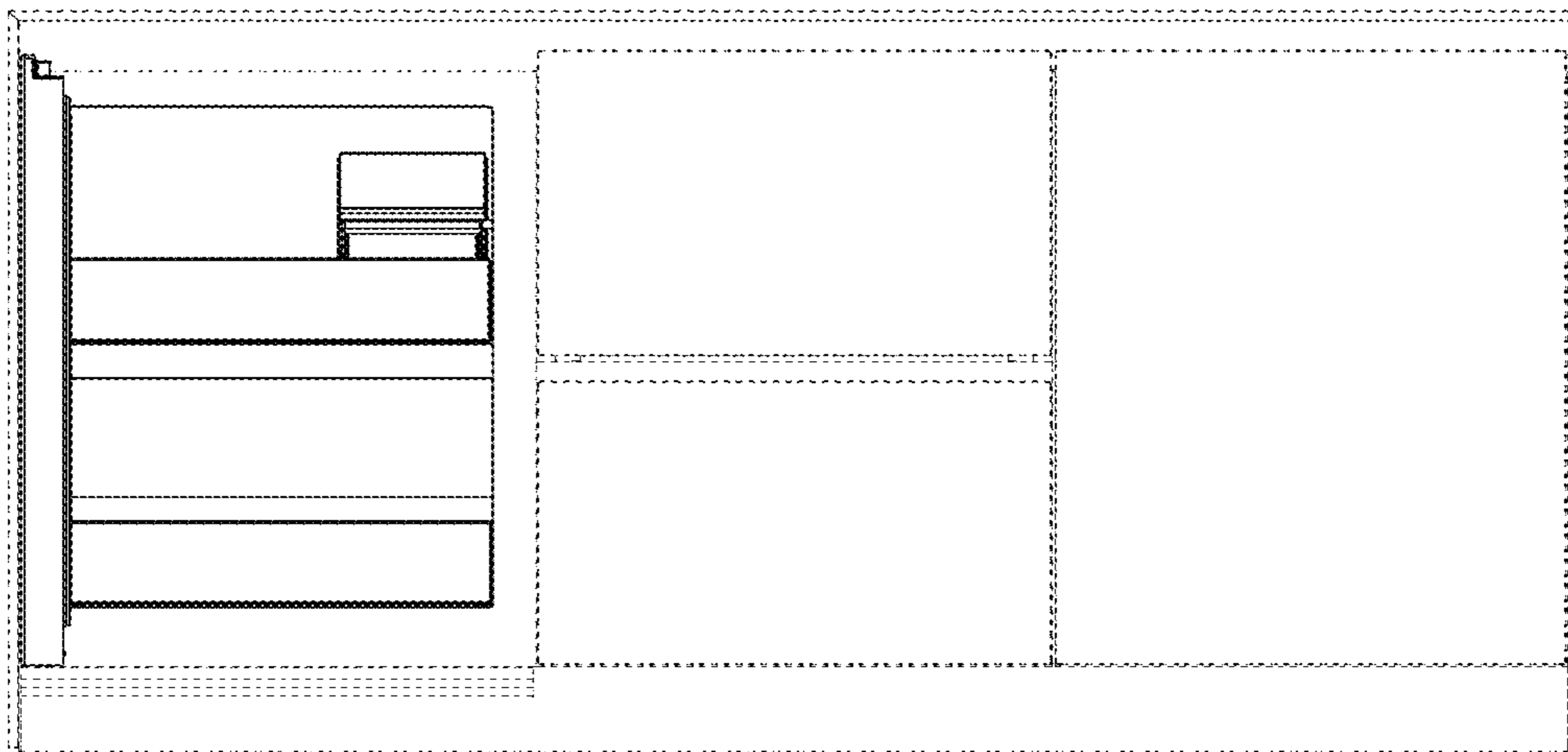

1.18

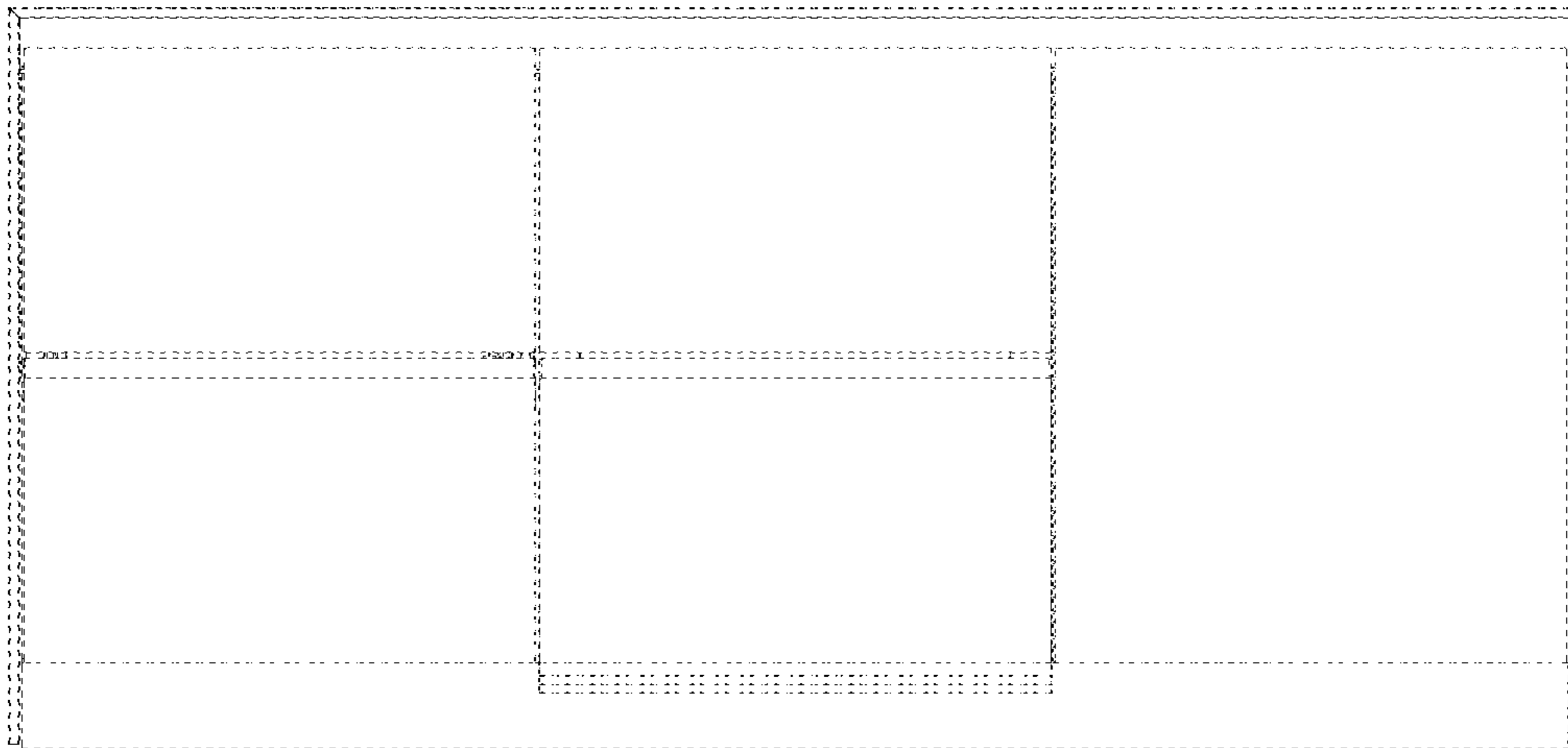

1.19

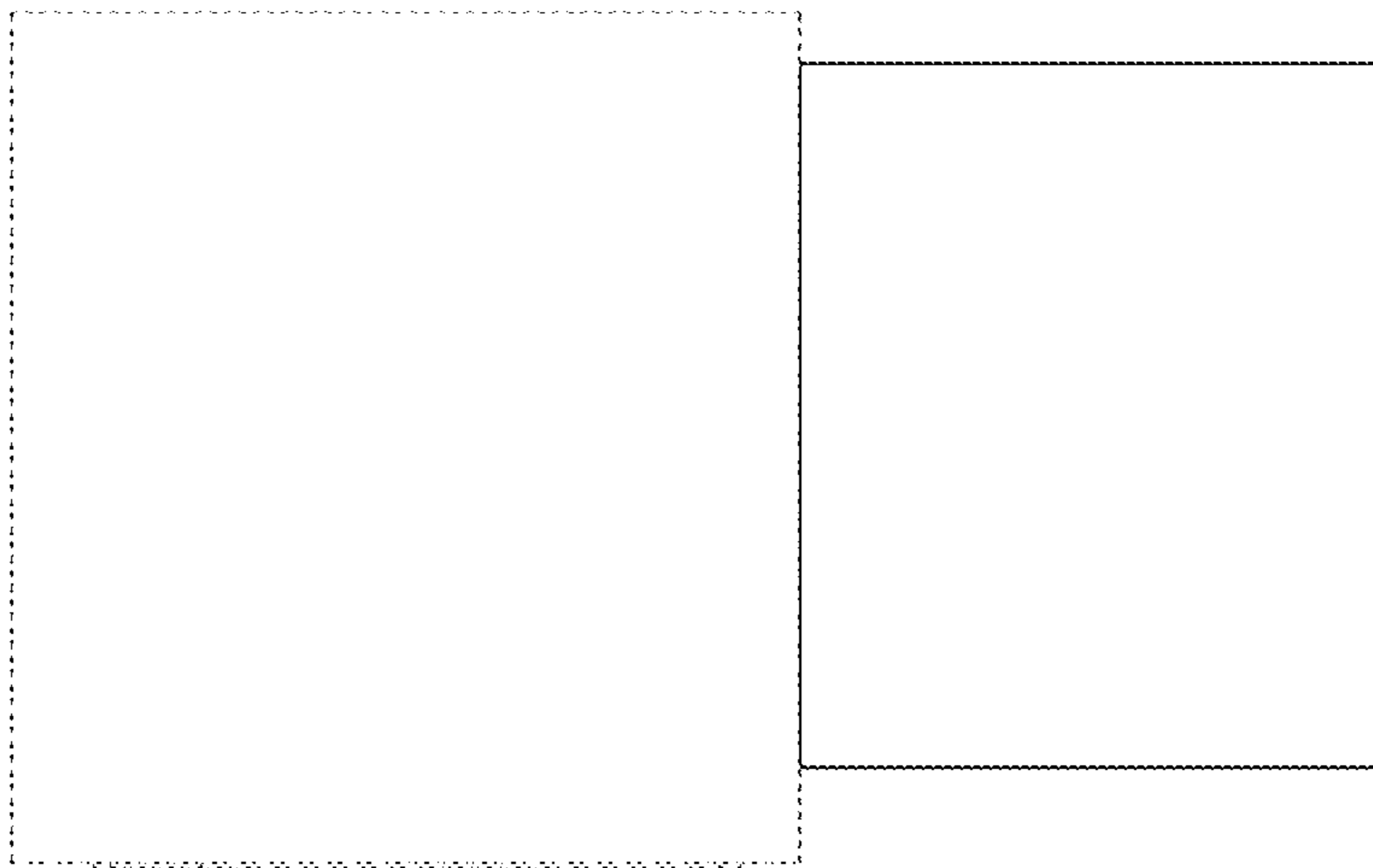

1.20

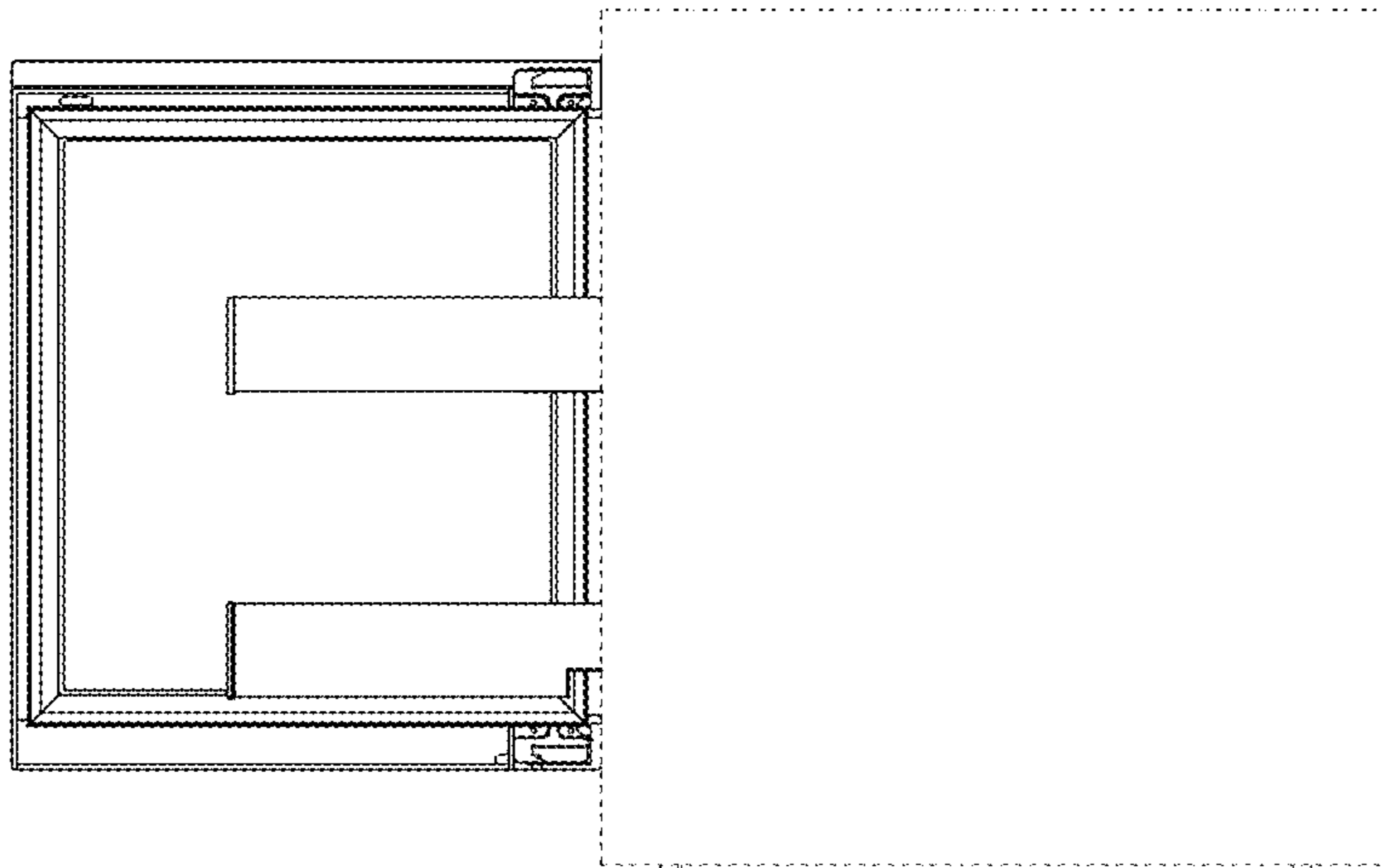

1.21

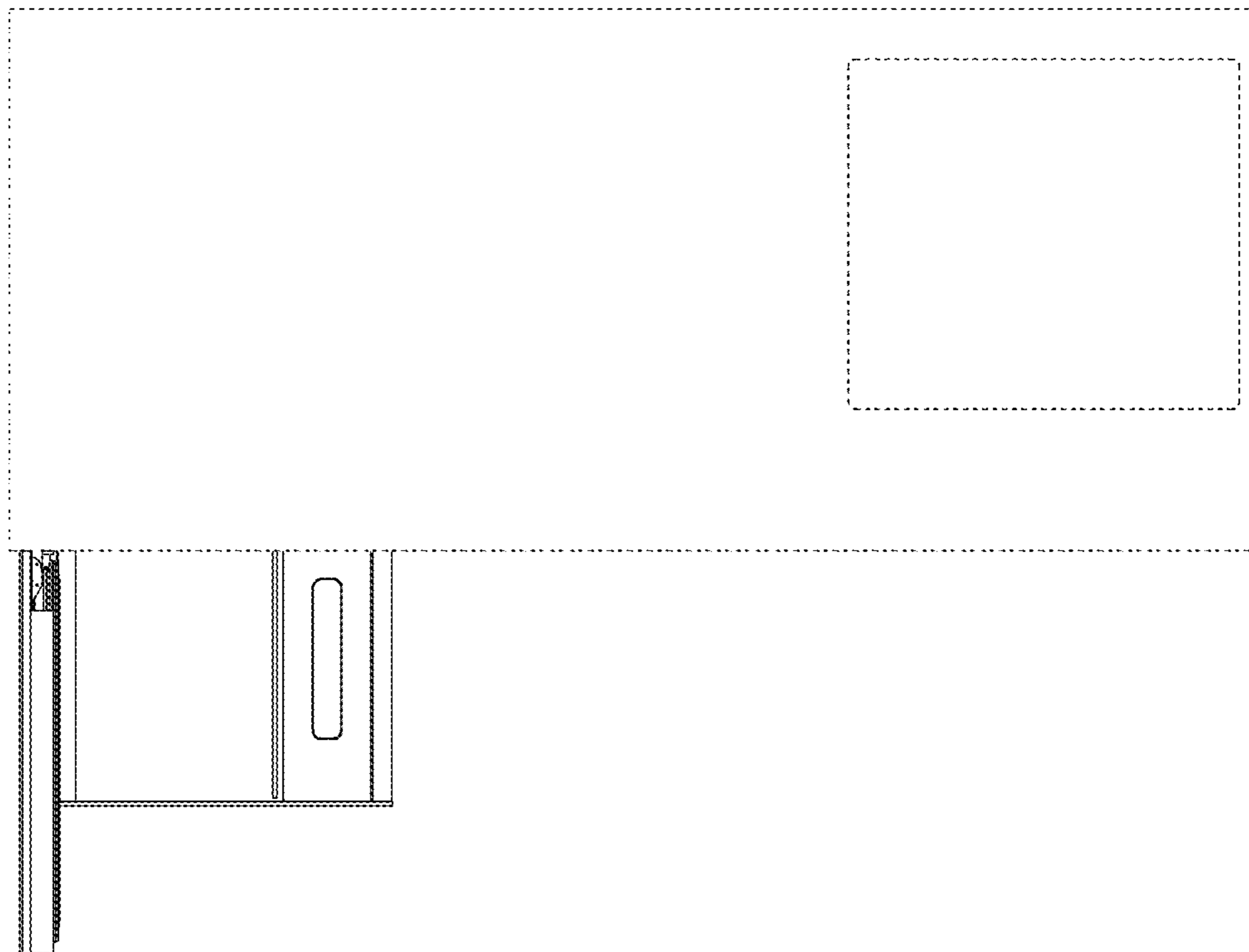

1.22

