



US00D900386S

(12) **United States Design Patent** (10) **Patent No.:** **US D900,386 S**
Wang (45) **Date of Patent:** **** Oct. 27, 2020**

(54) **ELECTRONIC CIGARETTE ASSEMBLY**

DESCRIPTION

(71) Applicant: **SHENZHEN SMOORE TECHNOLOGY LIMITED**,
Shenzhen, Guangdong (CN)
(72) Inventor: **Jianliang Wang**, Shenzhen (CN)
(73) Assignee: **Shenzhen Smoore Technology Limited**, Shenzhen (CN)
(**) Term: **15 Years**
(21) Appl. No.: **29/690,943**
(22) Filed: **May 13, 2019**
(30) **Foreign Application Priority Data**
Jan. 21, 2019 (CN) 2019 3 0031026
(51) **LOC (12) Cl.** **27-02**
(52) **U.S. Cl.**
USPC **D27/162**
(58) **Field of Classification Search**
USPC D27/162, 100, 101, 163-165, 172, 174,
D27/175, 183, 185-194; D24/110, 110.5;
(Continued)
(56) **References Cited**
U.S. PATENT DOCUMENTS
D323,292 S * 1/1992 Jones D9/424
D514,222 S * 1/2006 Anderson D24/110
(Continued)
Primary Examiner — Marissa J Cash
Assistant Examiner — Rebecca Tsehaye
(74) *Attorney, Agent, or Firm* — Ladas & Parry LLP

(57) **CLAIM**
The ornamental design for an electronic cigarette assembly,
as shown and described.

FIG. 1 is a perspective view of an electronic cigarette showing my new design shown as component 1 removed from the assembly in FIGS. 17-24 for clarity of disclosure; FIG. 2 is a rear view thereof; FIG. 3 is a left side view thereof; FIG. 4 is a right side view thereof; FIG. 5 is a top plan view thereof; FIG. 6 is a bottom plan view thereof; FIG. 7 is a front, right, and top perspective view thereof; FIG. 8 is a rear, left, and bottom perspective view thereof; FIG. 9 is a perspective view of the electronic cigarette showing my new design shown as component 2 removed from the assembly in FIGS. 17-24 for clarity of disclosure; FIG. 10 is a rear view thereof; FIG. 11 is a left side view thereof; FIG. 12 is a right side view thereof; FIG. 13 is a top plan view thereof; FIG. 14 is a bottom plan view thereof; FIG. 15 is a front, right, and top perspective view thereof; FIG. 16 is a rear, left, and bottom perspective view thereof; FIG. 17 is a perspective view of the electronic cigarette showing my new design where component 1 and component 2 are shown in an assembled state of use; FIG. 18 is a rear view thereof; FIG. 19 is a left side view thereof; FIG. 20 is a right side view thereof; FIG. 21 is a top plan view thereof; FIG. 22 is a bottom plan view thereof; FIG. 23 is a front, right, and top perspective view thereof; and, FIG. 24 is a rear, left, and bottom perspective view thereof. The broken lines in the drawings depict portions of the electronic cigarette that form no part of the claimed design.

1 Claim, 24 Drawing Sheets

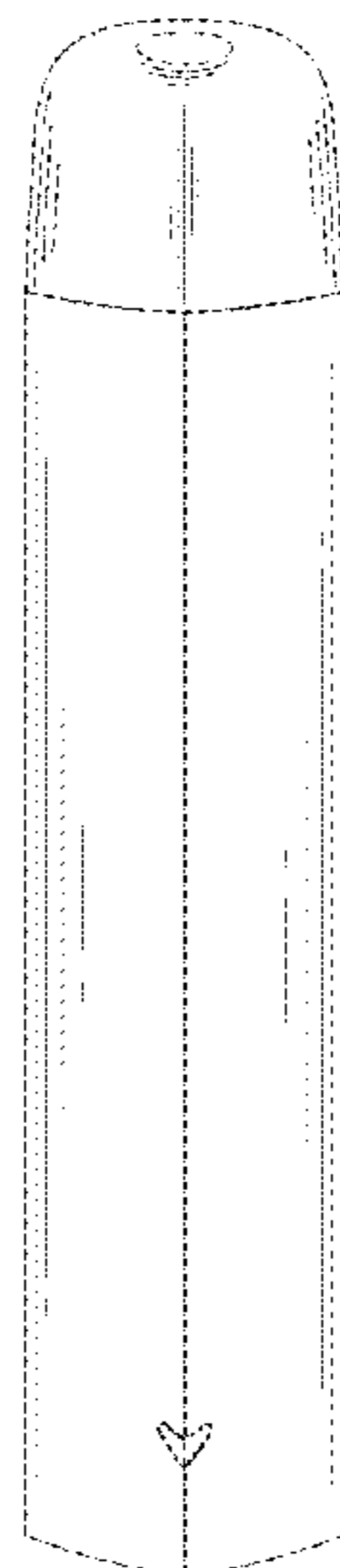

(58) **Field of Classification Search**

USPC D13/107-109; 128/202.21, 203.12;
131/273, 274, 270, 191, 328, 329, 330,
131/360-365

CPC A24F 47/002; A24F 47/006; A24F 47/008;
A61M 15/00; A61M 15/06

See application file for complete search history.

(56) **References Cited**

U.S. PATENT DOCUMENTS

D613,395 S *	4/2010	Nakao	D24/110
D661,795 S *	6/2012	Clarke	D24/110
D763,502 S *	8/2016	Verleur	D27/167
D820,514 S *	6/2018	Durand	D27/162
D820,515 S *	6/2018	Nettenstrom	D27/167
D846,796 S *	4/2019	Pan	D27/101
D853,632 S *	7/2019	Qiu	D27/101
D869,085 S *	12/2019	Campbell	D27/162
D870,368 S *	12/2019	Leon Duque	D27/162
D872,934 S *	1/2020	Powell	D27/163
D875,302 S *	2/2020	Pan	D27/162
D875,303 S *	2/2020	Pan	D27/162
D875,305 S *	2/2020	Lai	D27/167
D875,306 S *	2/2020	Pan	D27/167
D880,053 S *	3/2020	Han	D27/162
D881,460 S *	4/2020	Han	D27/162
2019/0053542 A1 *	2/2019	Chen	A61M 11/042

* cited by examiner

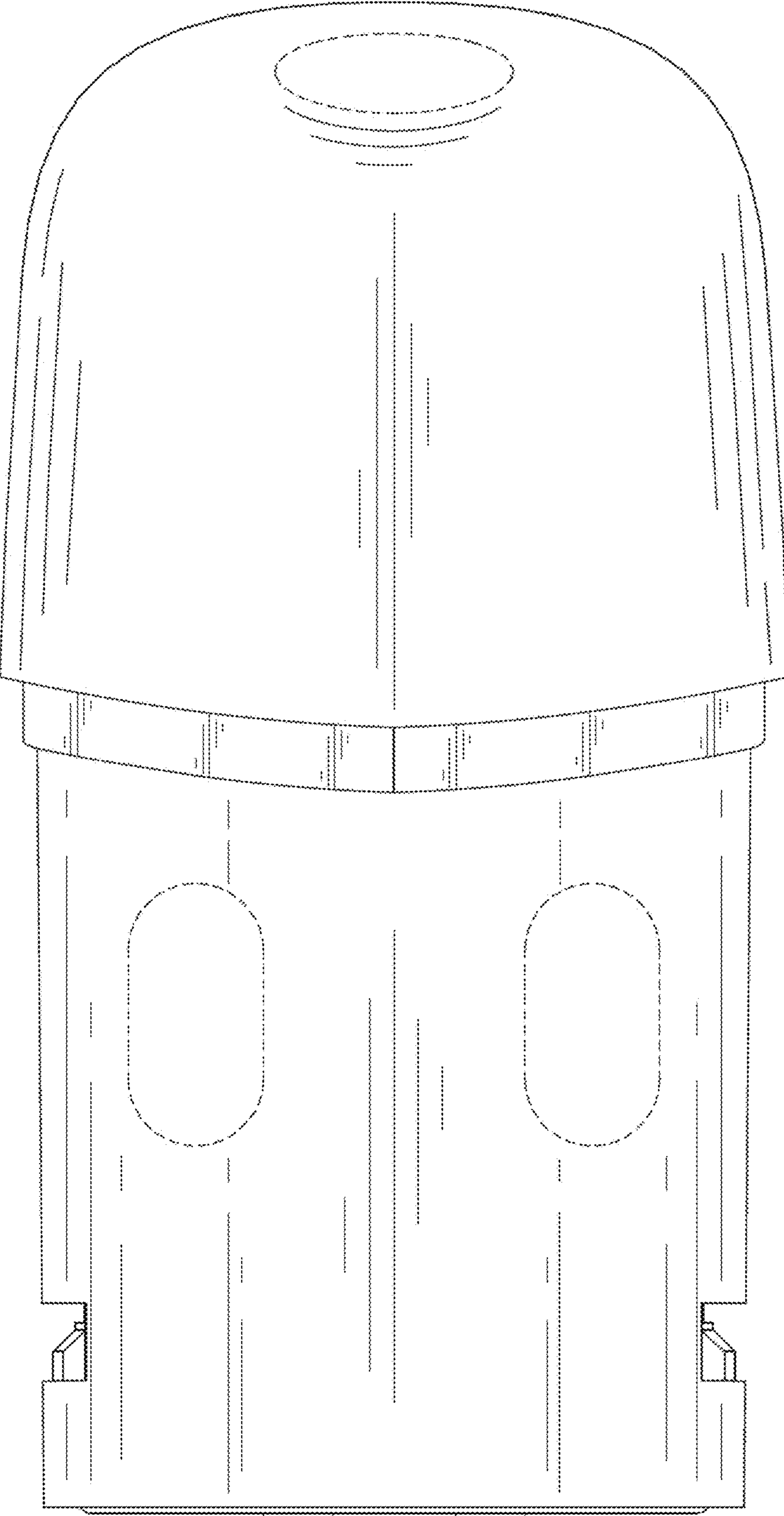

FIG. 1

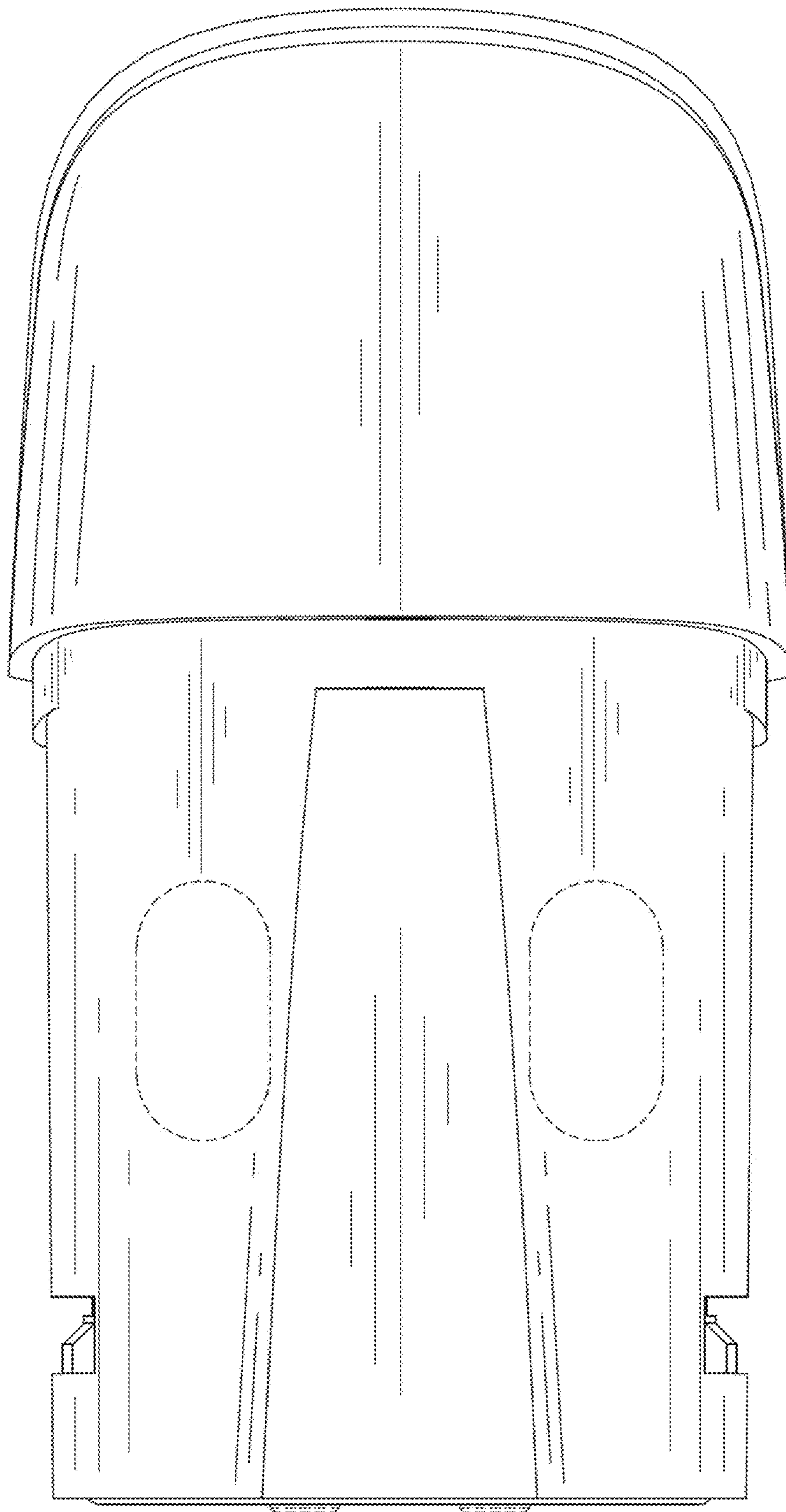

FIG. 2

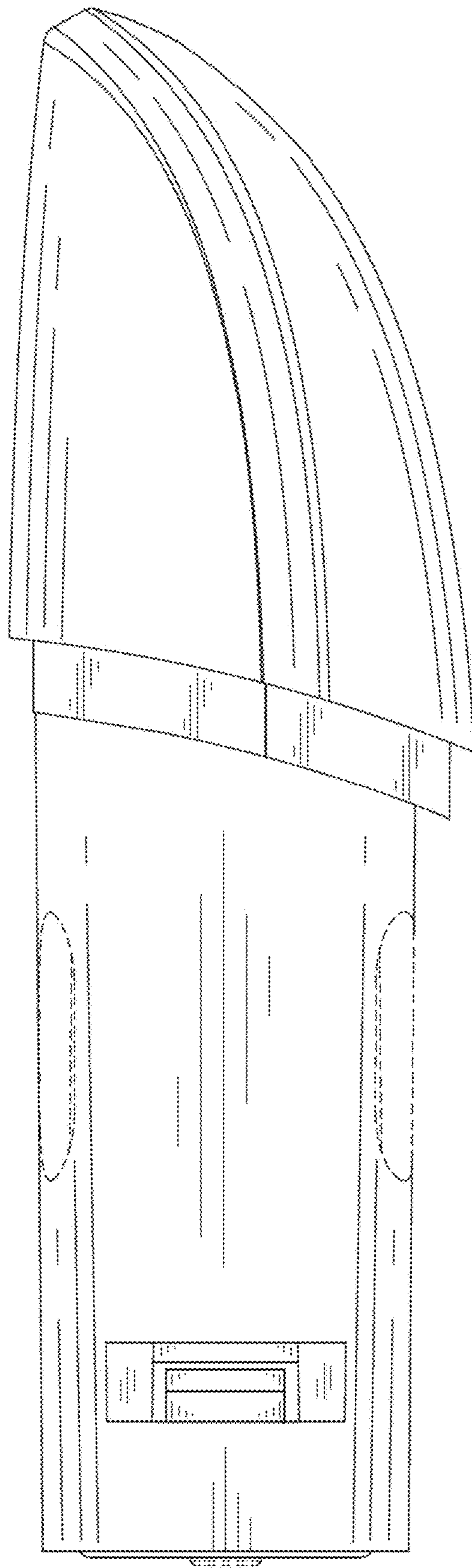

FIG. 3

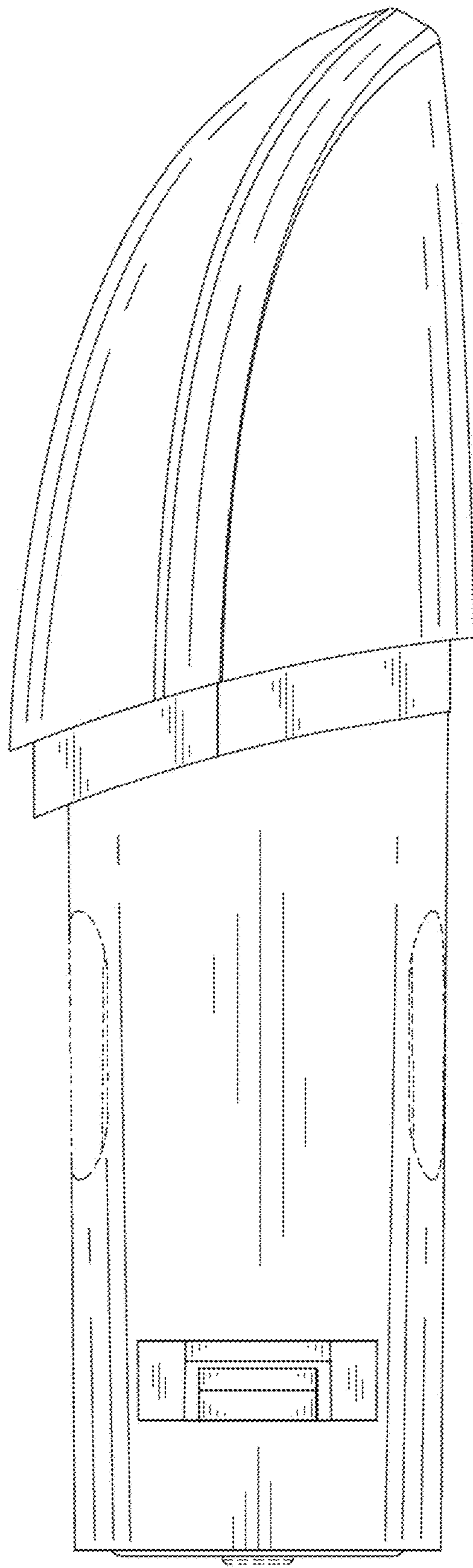

FIG. 4

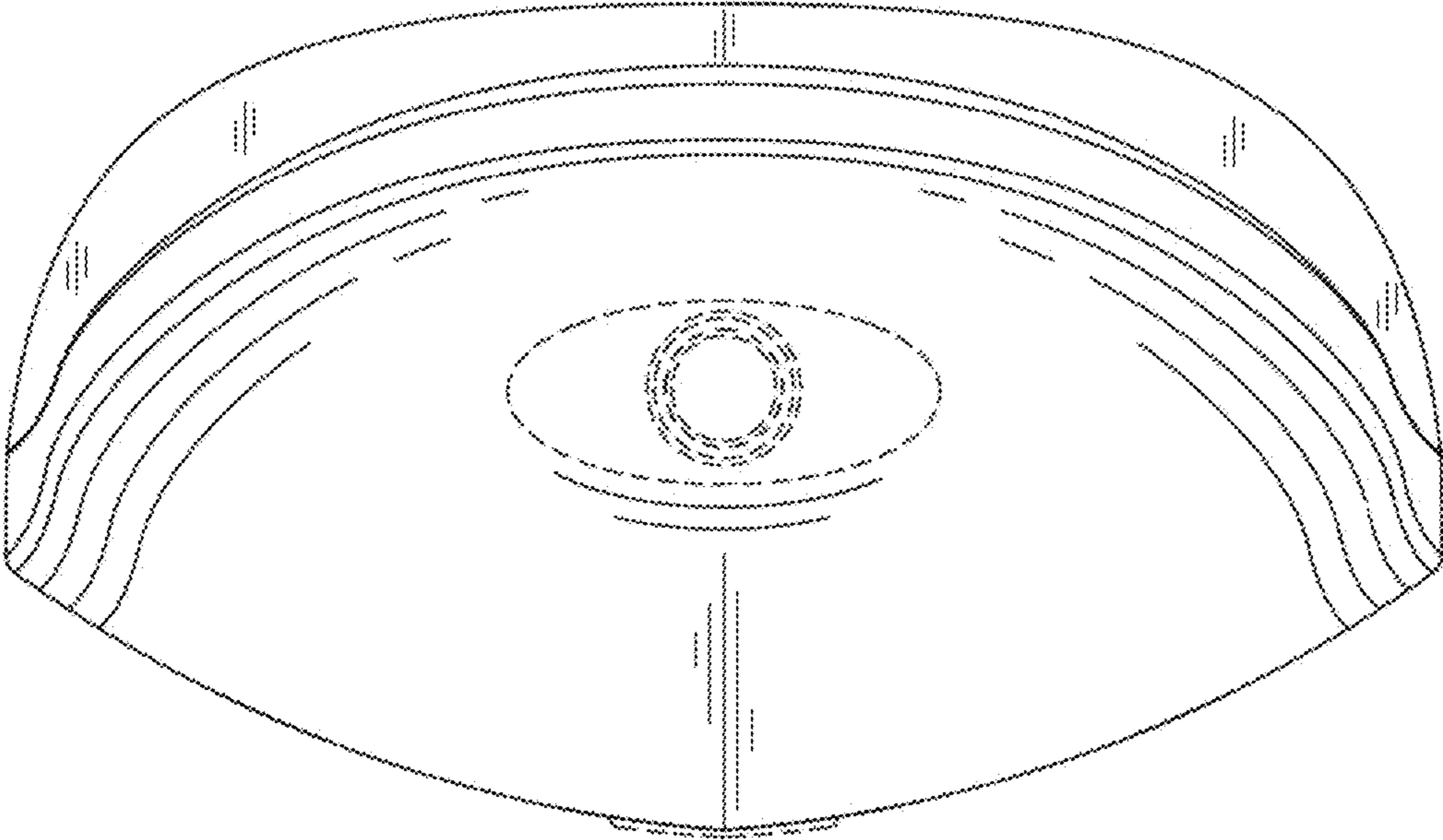

FIG. 5

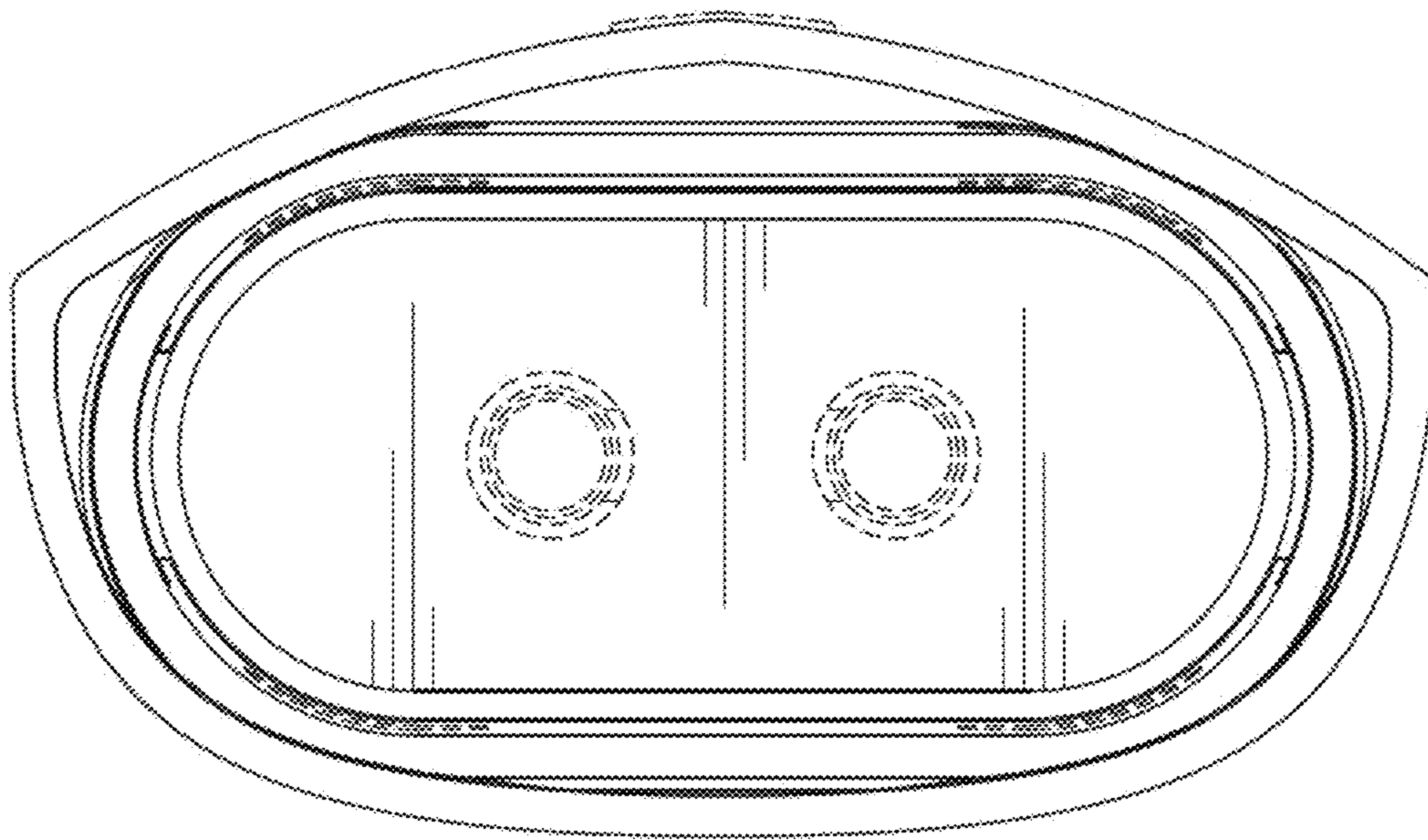

FIG. 6

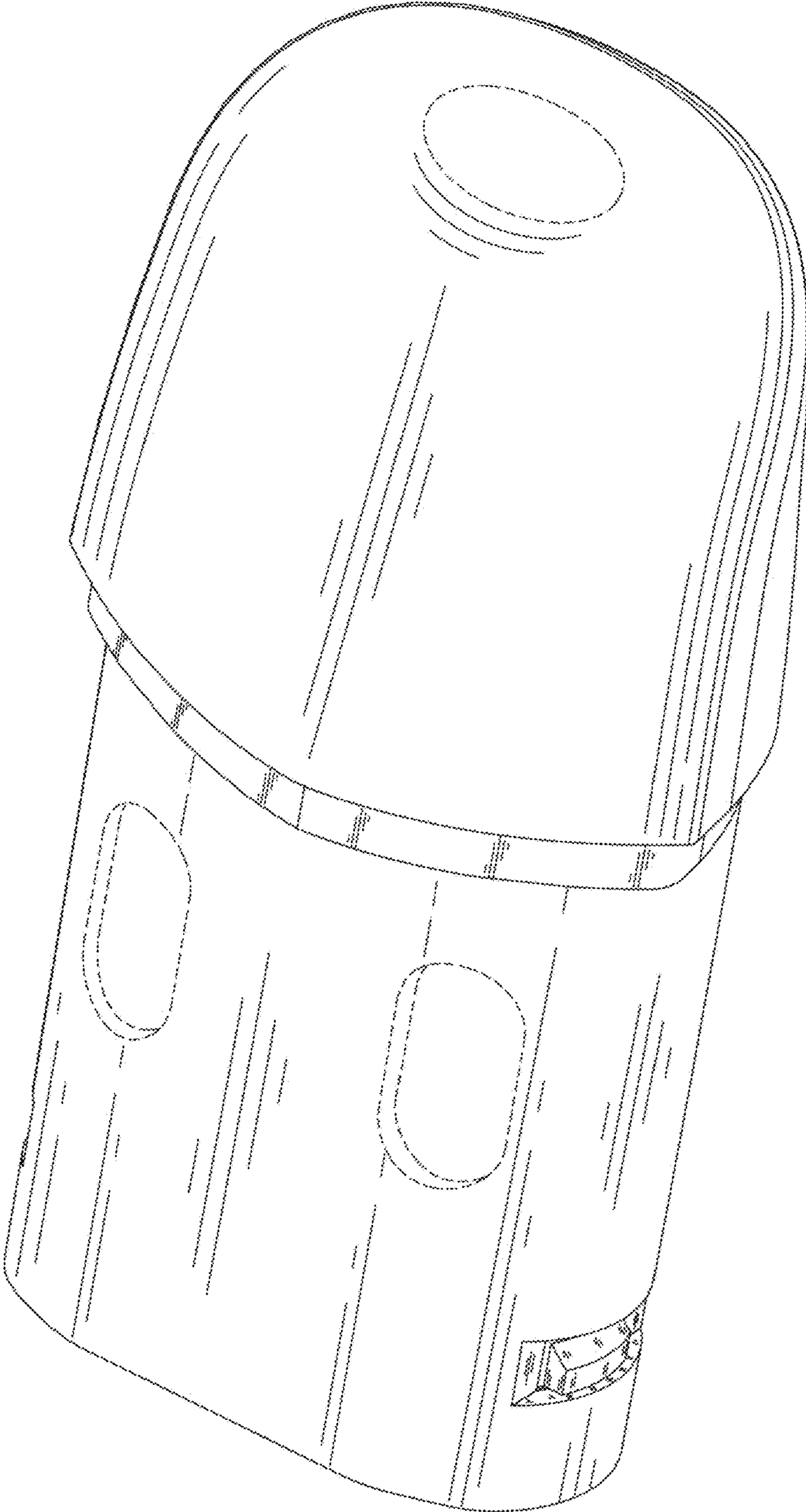

FIG. 7

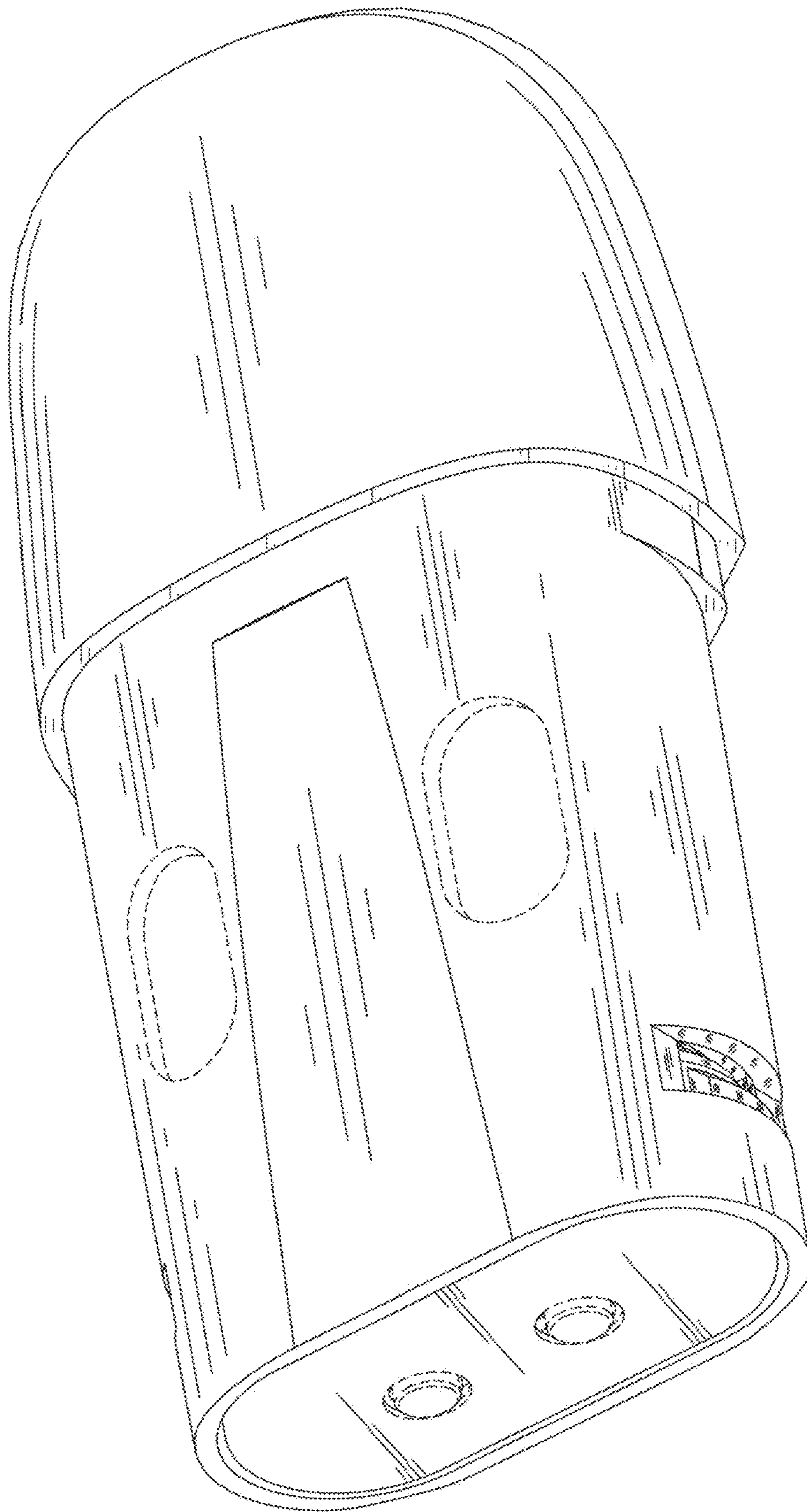

FIG. 8

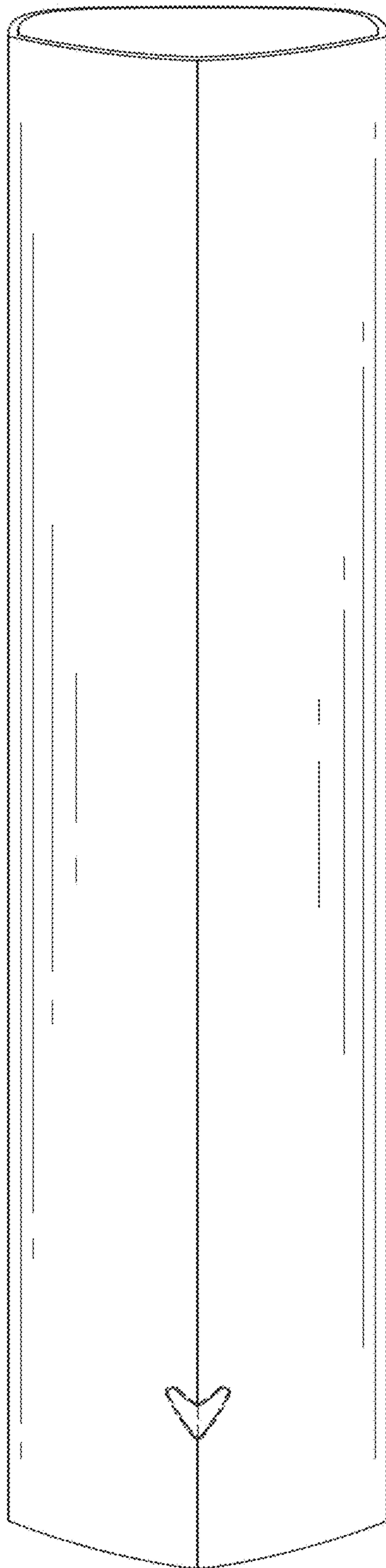

FIG. 9

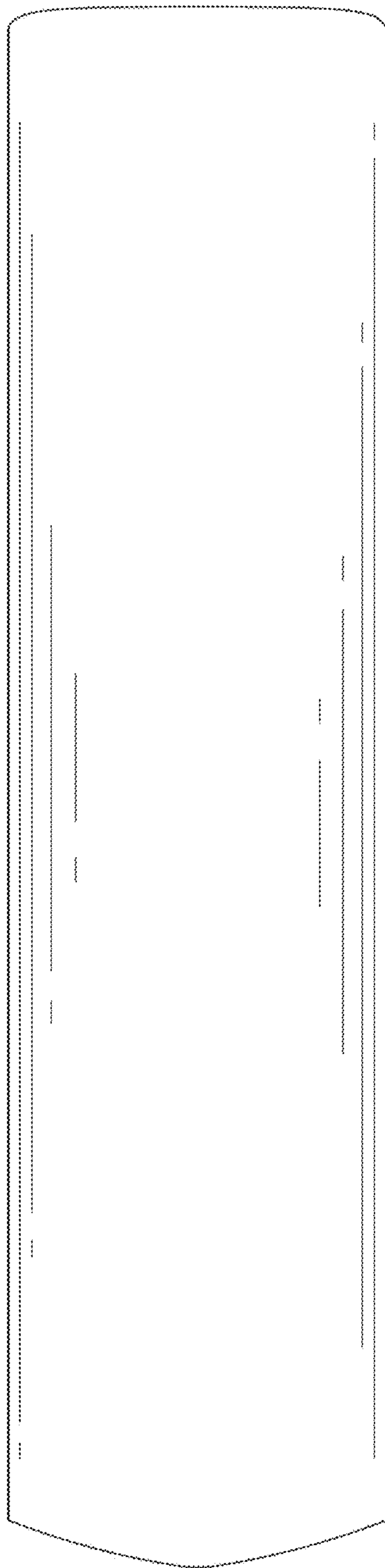

FIG. 10

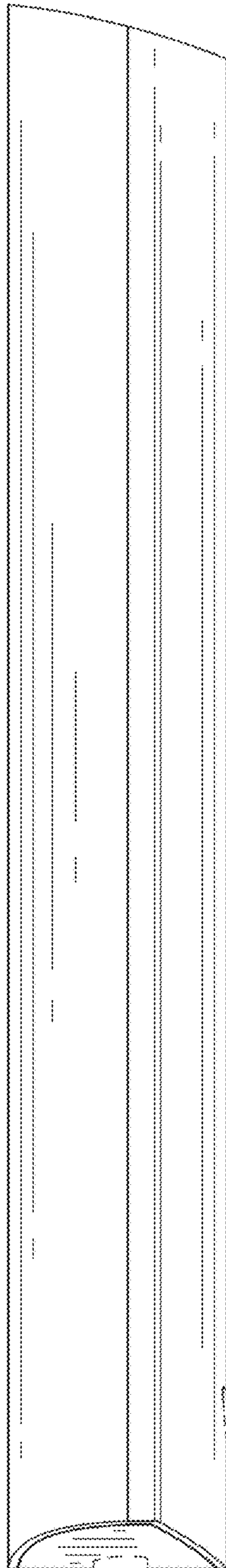

FIG. 11

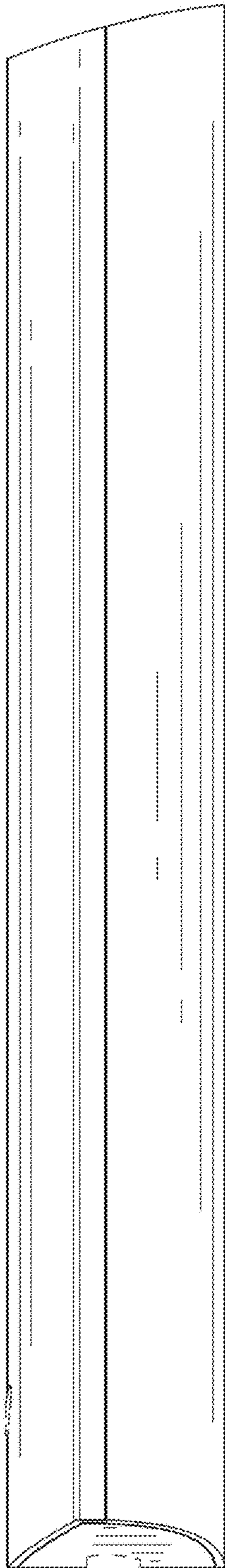

FIG. 12

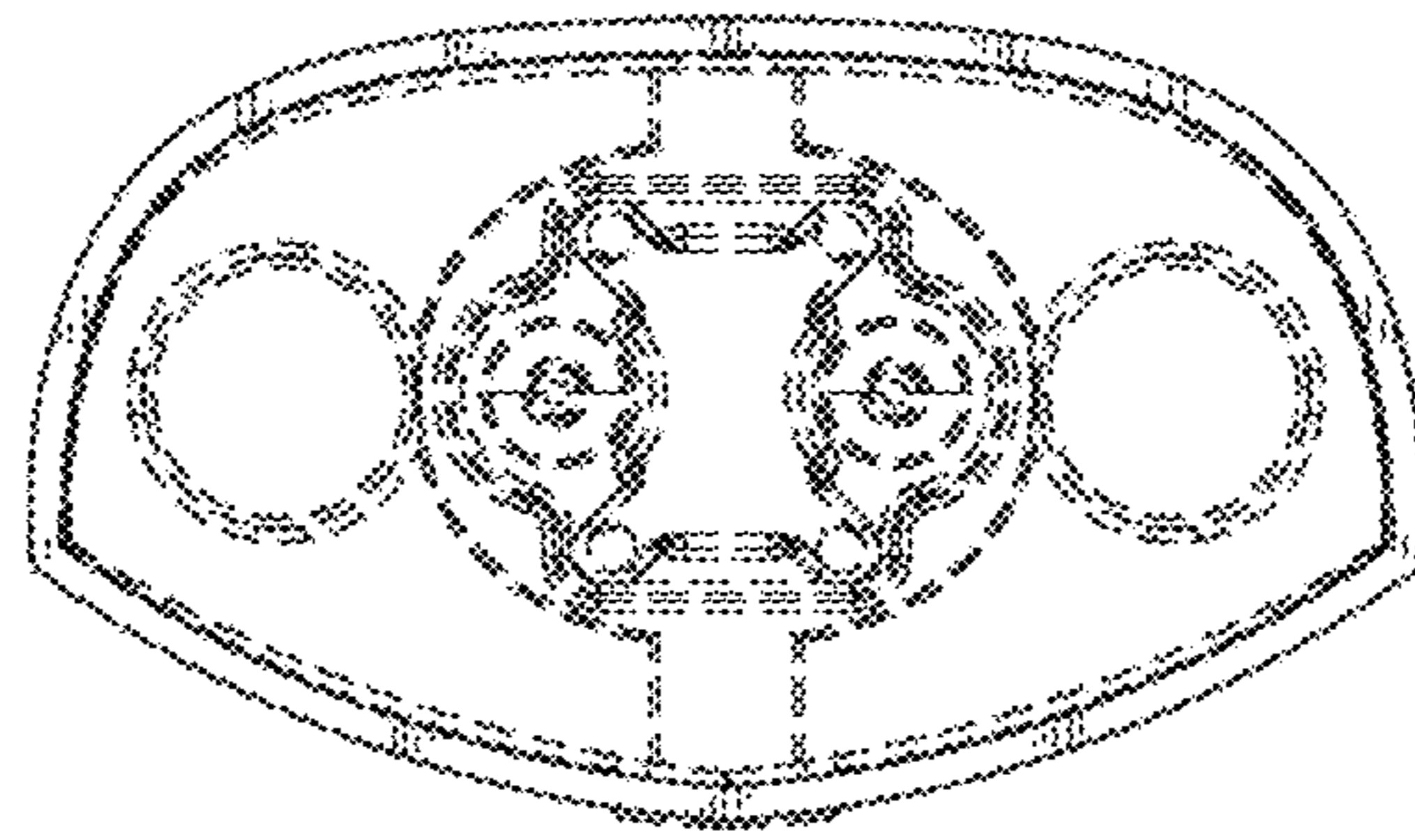

FIG. 13

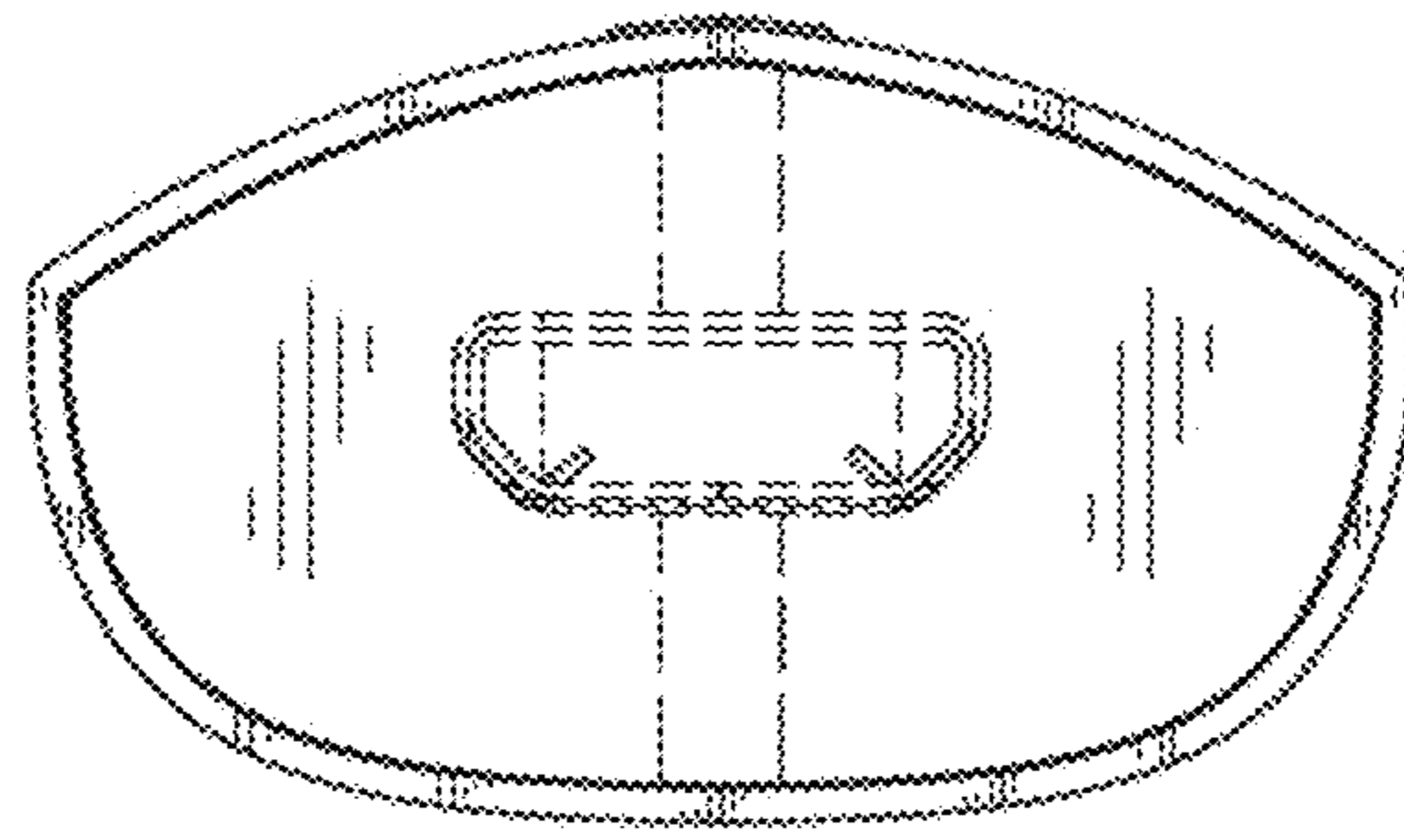

FIG. 14

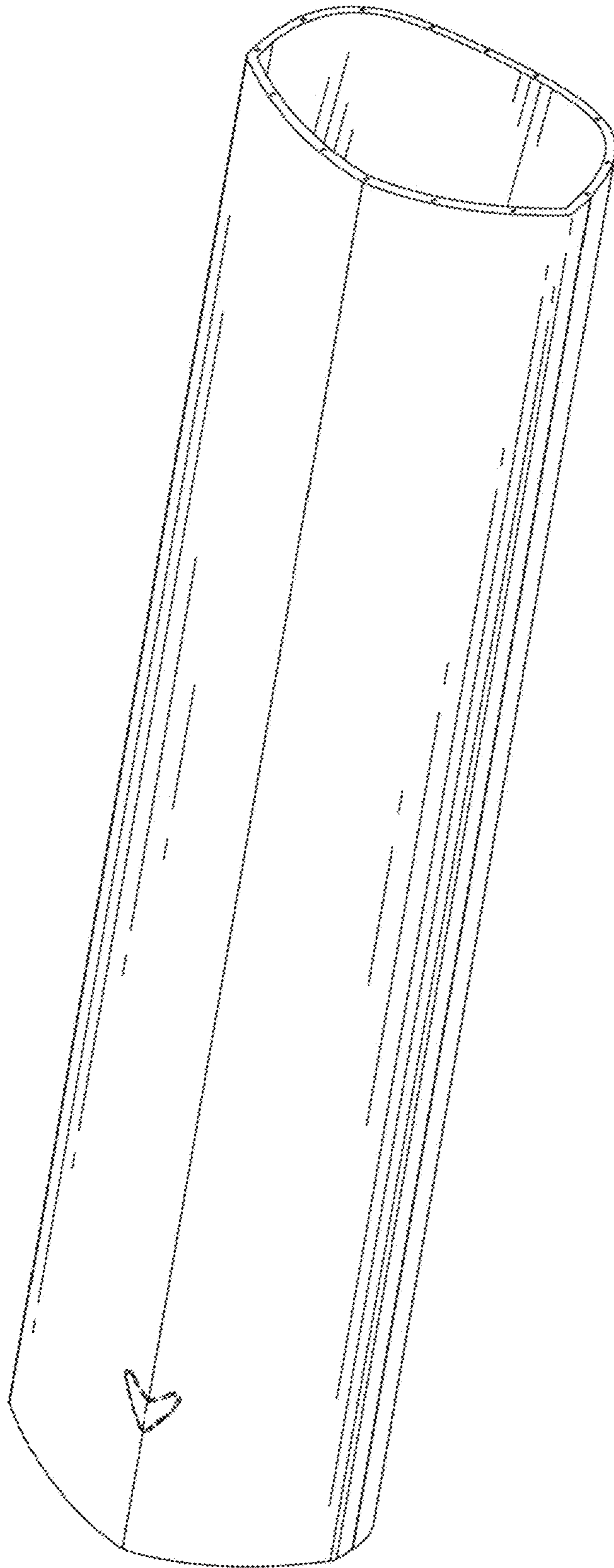

FIG. 15

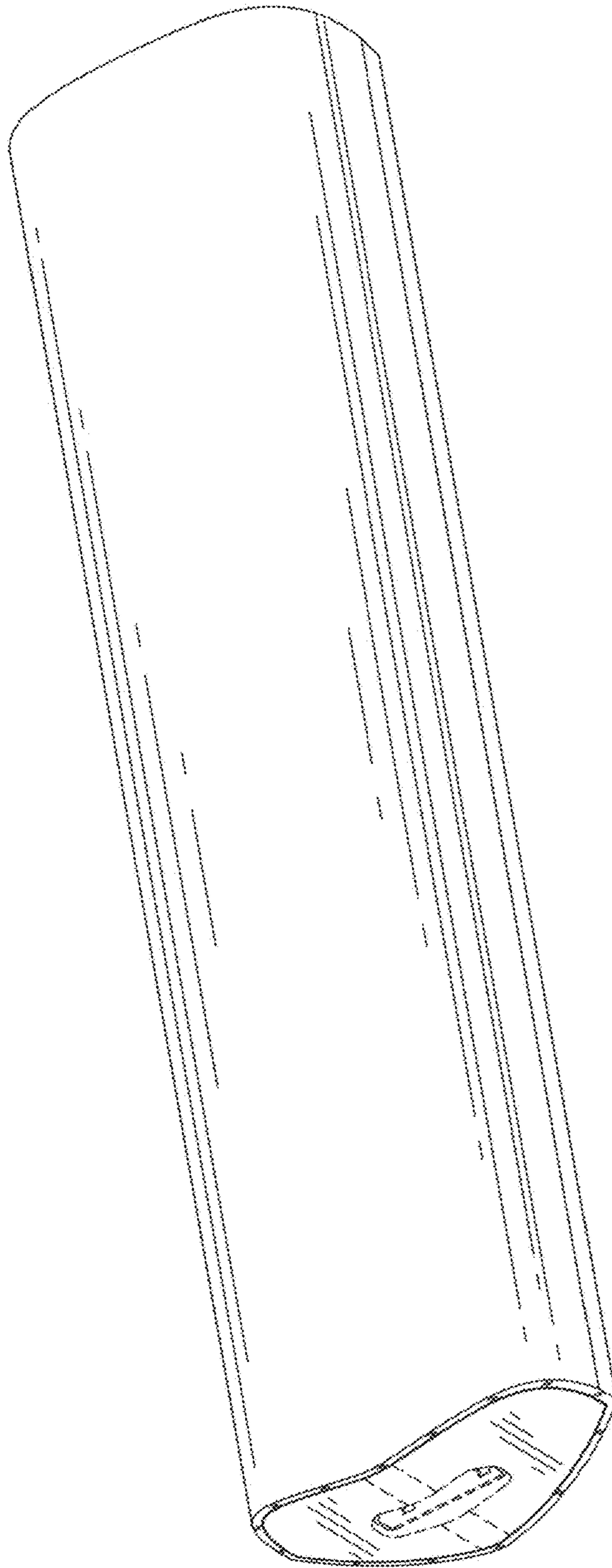

FIG. 16

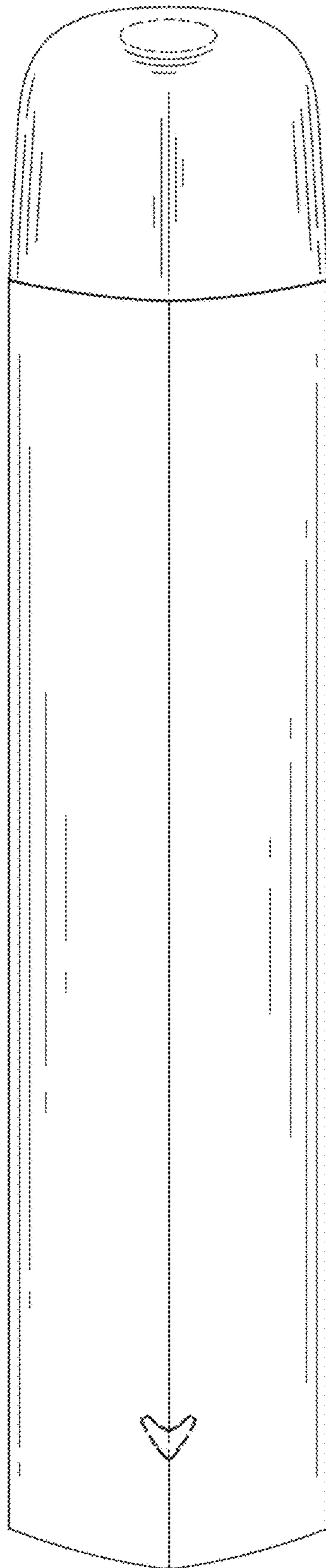

FIG. 17

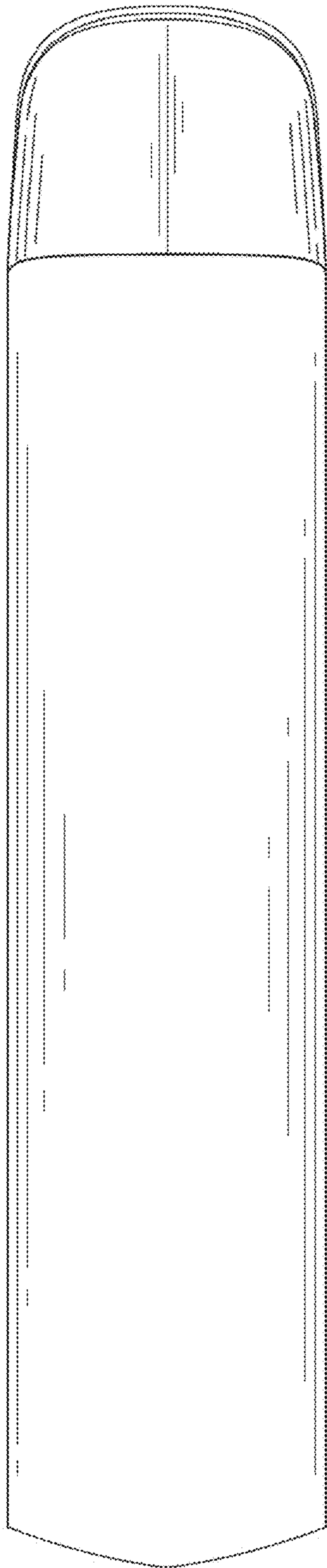

FIG. 18

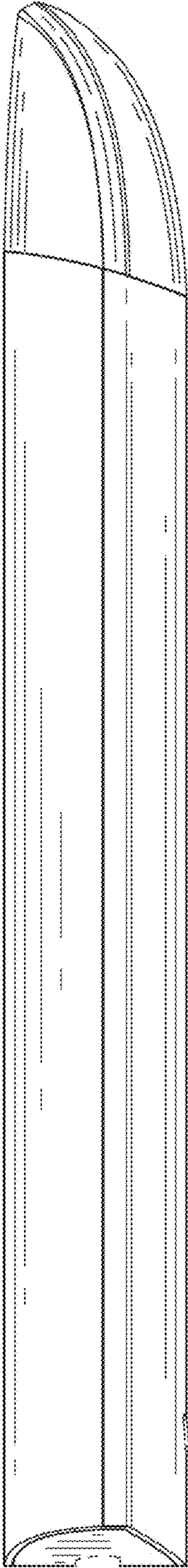

FIG.19

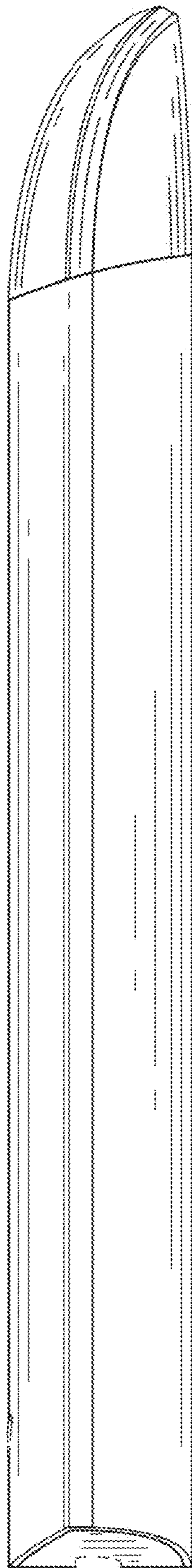

FIG.20

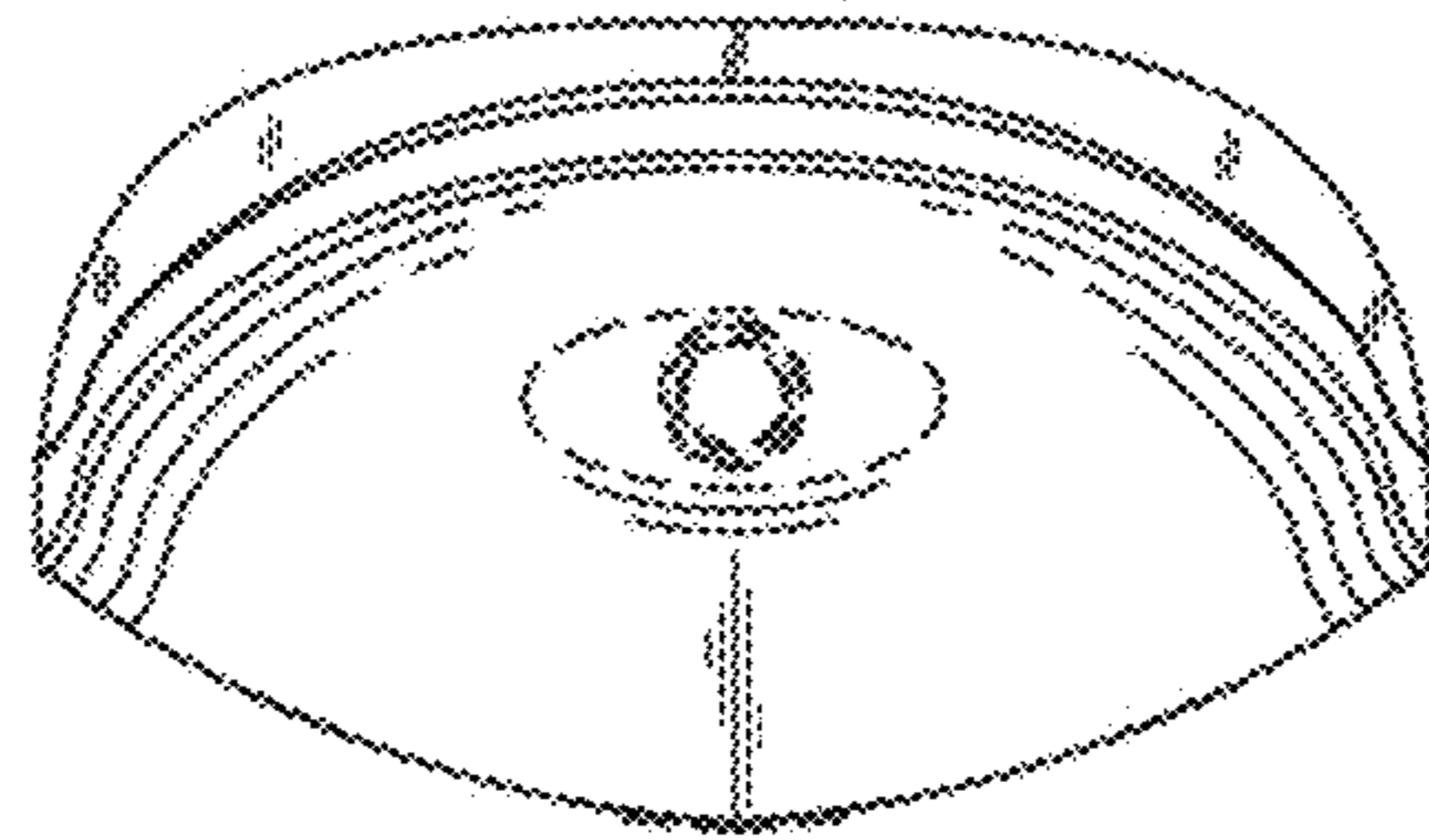

FIG. 21

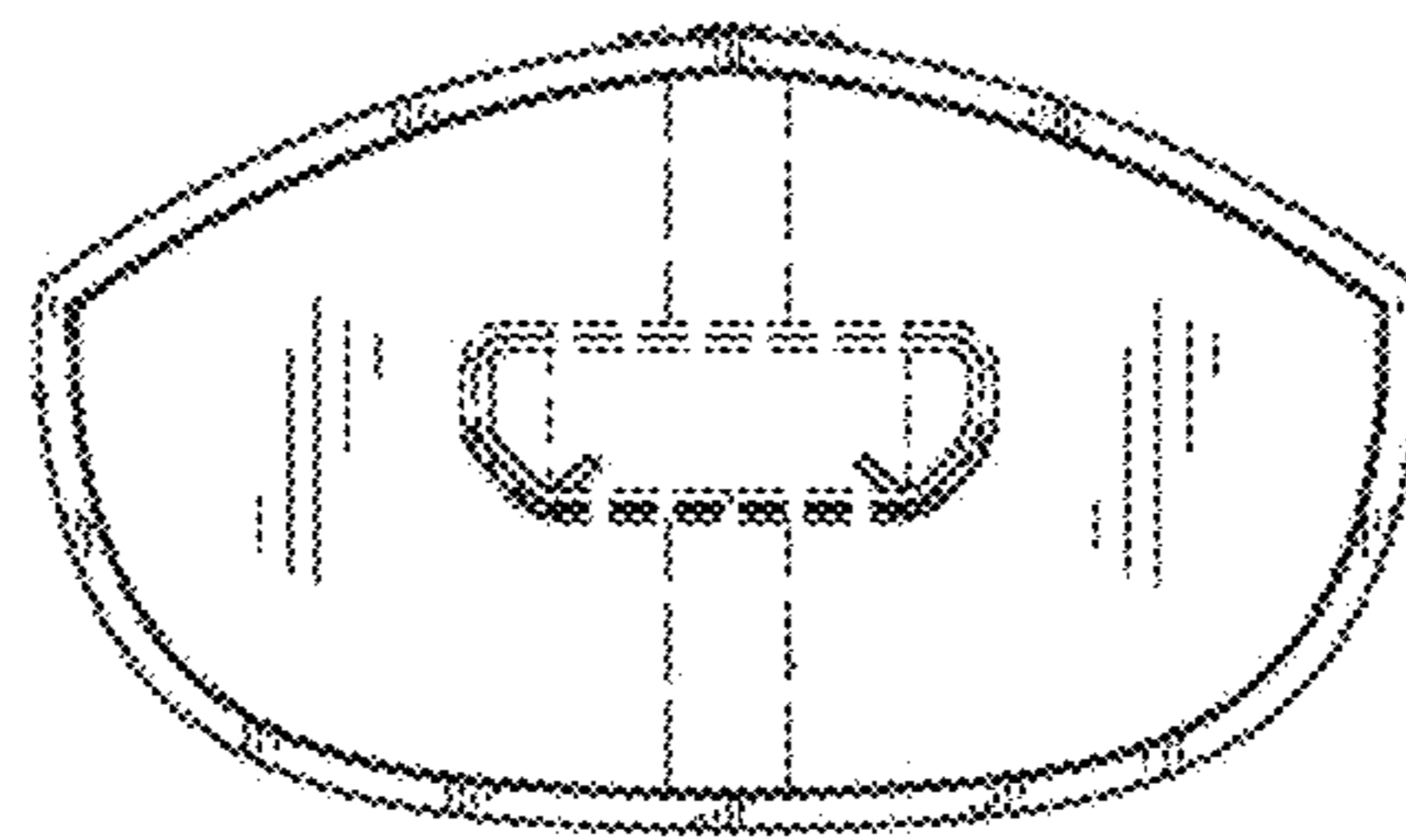

FIG. 22

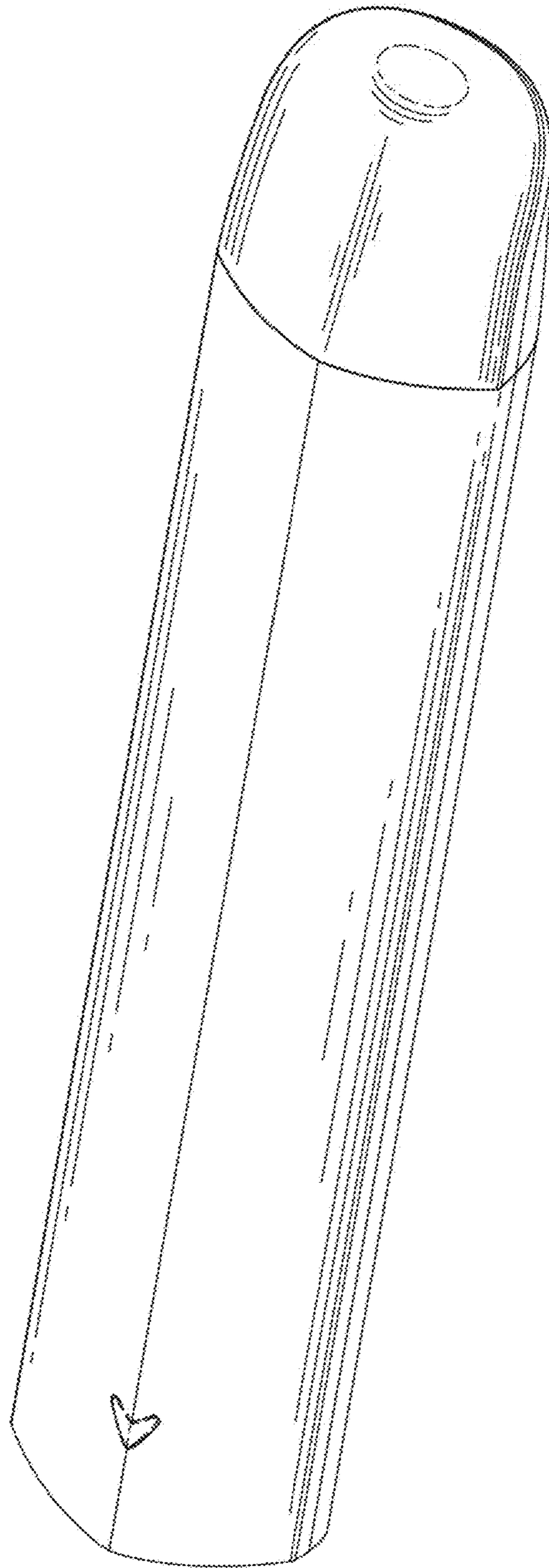

FIG. 23

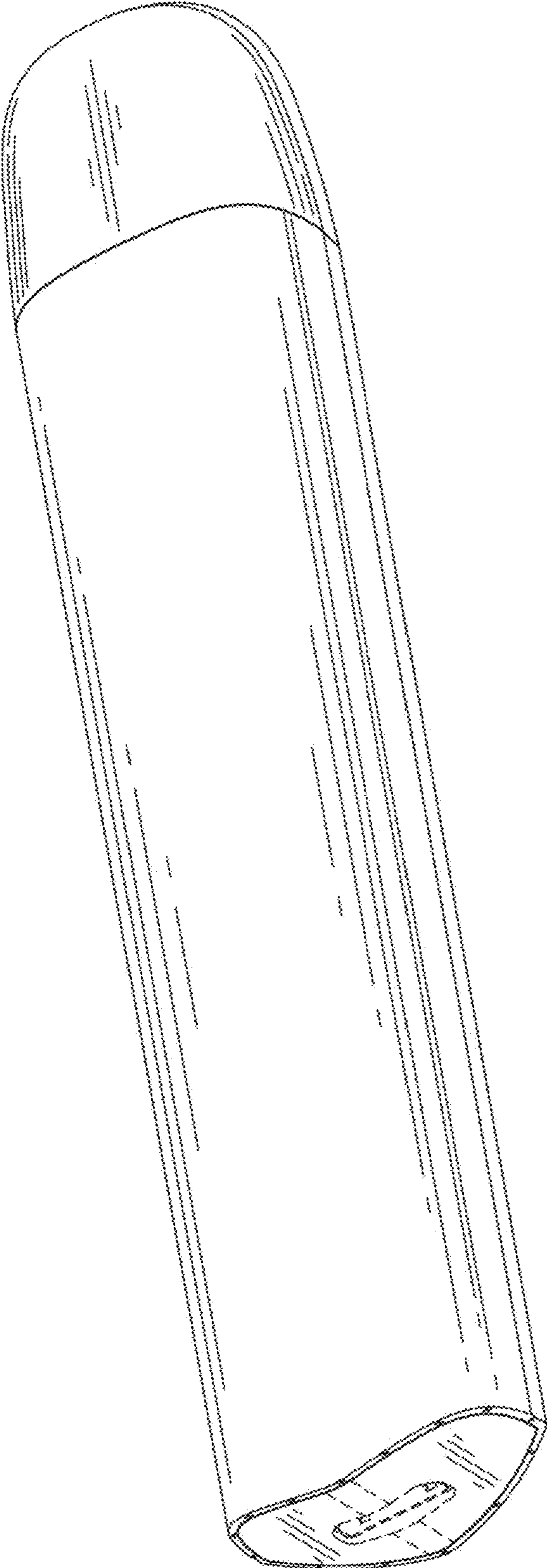

FIG. 24