



US00D900328S

(12) **United States Design Patent** (10) **Patent No.:** **US D900,328 S**  
**Barski** (45) **Date of Patent:** **\*\* Oct. 27, 2020**

(54) **COMBINED MITTEN AND PACIFIER**  
(71) Applicant: **Karen H Barski**, Milton, GA (US)  
(72) Inventor: **Karen H Barski**, Milton, GA (US)  
(\*\*) Term: **15 Years**  
(21) Appl. No.: **29/634,229**  
(22) Filed: **Jan. 19, 2018**  
(51) **LOC (12) Cl.** ..... **24-04**  
(52) **U.S. Cl.**  
USPC ..... **D24/194**  
(58) **Field of Classification Search**  
USPC ..... D24/193, 194, 195, 214; D1/106, 107,  
D1/115, 125, 199; D21/418, 483, 496,  
D21/576, 584, 621, 628, 650, 684;  
D29/113, 118, 121.2; D30/160; D2/605,  
D2/606, 607, 614, 622, 980, 983, 984  
CPC ..... A61J 17/111; A41D 19/0024  
See application file for complete search history.

2006/0004412 A1\* 1/2006 Gilbert, Jr. .... A41D 19/01  
606/234  
2006/0041275 A1 2/2006 Powers  
2007/0288056 A1 12/2007 Goldwire  
2009/0143822 A1 6/2009 Perry  
2009/0163952 A1 6/2009 Kash  
2011/0107497 A1 5/2011 Kang  
2012/0265244 A1\* 10/2012 Valderrama ..... A61J 17/001  
606/234  
2014/0207187 A1 7/2014 Kiraly  
2015/0004872 A1\* 1/2015 Taylor ..... A63H 3/02  
446/227  
2016/0106631 A1 4/2016 Rohrig  
2019/0358129 A1\* 11/2019 Bergstrom ..... A61J 17/113

**OTHER PUBLICATIONS**

“Woombie PaciMitts with Attached Pacifier”. Found online Jul. 17, 2020 at amazon.com. Reference dated Feb. 12, 2019. Retrieved from [https://www.amazon.com/Woombie-PaciMitts-Attached-Pacifier-Scratching/dp/B07WRMFYZR/ref=cm\\_cr\\_arp\\_d\\_product\\_top?ie=UTF8](https://www.amazon.com/Woombie-PaciMitts-Attached-Pacifier-Scratching/dp/B07WRMFYZR/ref=cm_cr_arp_d_product_top?ie=UTF8).\*

(Continued)

*Primary Examiner* — Kendra Leslie Hamilton  
(74) *Attorney, Agent, or Firm* — Mark P. Stone

(56) **References Cited**

**U.S. PATENT DOCUMENTS**

2,586,608 A 2/1952 Bryson  
D245,335 S \* 8/1977 Meeker ..... D24/194  
5,385,573 A 1/1995 Wright  
D499,512 S \* 12/2004 Chlebowski ..... D29/118  
D593,278 S \* 6/2009 Kimm ..... D2/622  
8,241,327 B1 \* 8/2012 Moore ..... A61J 17/10  
606/234  
D686,331 S \* 7/2013 Dussere ..... D24/194  
D713,968 S \* 9/2014 Hyslop ..... D24/195  
D748,811 S \* 2/2016 Lee ..... D24/194  
9,560,888 B2 2/2017 Kiraly  
D840,634 S \* 2/2019 Steward ..... D2/622  
2002/0082642 A1\* 6/2002 Shattles ..... A61J 17/00  
606/234  
2003/0226190 A1 12/2003 Jackson  
2005/0222621 A1 10/2005 Duwelius et al.

(57) **CLAIM**

The ornamental design for “combined mitten and pacifier”, as shown and described.

**DESCRIPTION**

FIG. 1 is a top, rear, left perspective view of a combined mitten and pacifier, showing my new design;  
FIG. 2 is a top plan view thereof;  
FIG. 3 is a bottom plan view thereof;  
FIG. 4 is a front elevation view thereof;  
FIG. 5 is a rear elevation view thereof; and,  
FIG. 6 is a left side elevation view thereof.

**1 Claim, 3 Drawing Sheets**

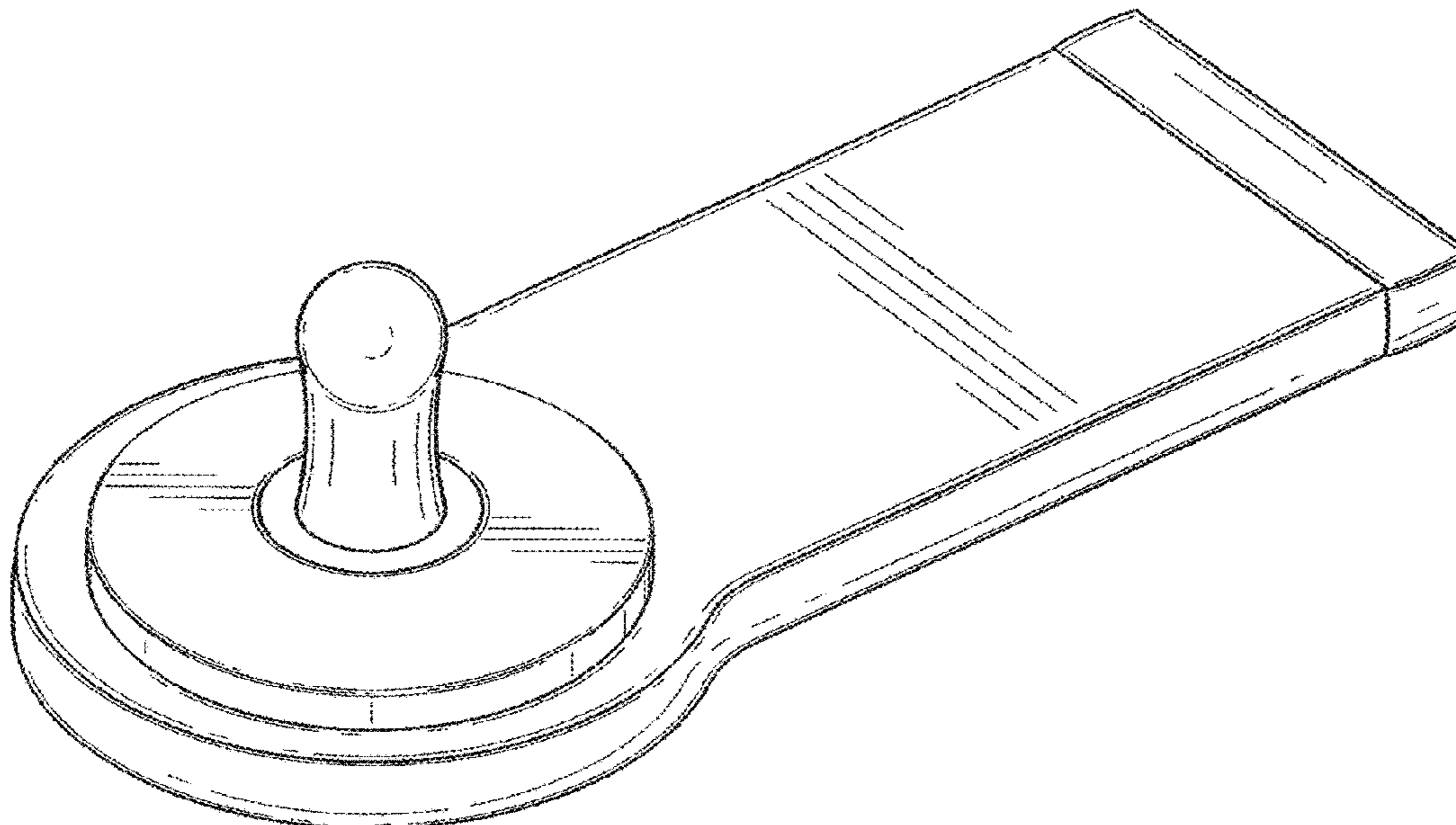

(56)

**References Cited**

OTHER PUBLICATIONS

“Gummee Glove: Review”. Found online Nov. 2, 2016 at [hartofthemunchkinpatch.co.uk](http://www.hartofthemunchkinpatch.co.uk). Reference dated Oct. 25, 2012. Retrieved from <http://www.hartofthemunchkinpatch.co.uk/2012/10/our-review-of-gummee-glove.html>.\*

“Munch Mitt Baby’s Teething Mitten”. Found online Apr. 29, 2019 at [amazon.in](https://www.amazon.in/). Reference dated Dec. 21, 2015. Retrieved from [https://www.amazon.in/. . . d\\_rd\\_wg=NfvPV&pf\\_rd\\_p=87667aae-831c-4952-ab47-0ae2a4d747da&pf\\_rd\\_r=6NV20KT0PND44NTSRA2Q&psc=1&refRID=6NV20KT0PND44NTSRA2Q](https://www.amazon.in/. . . d_rd_wg=NfvPV&pf_rd_p=87667aae-831c-4952-ab47-0ae2a4d747da&pf_rd_r=6NV20KT0PND44NTSRA2Q&psc=1&refRID=6NV20KT0PND44NTSRA2Q).\*

\* cited by examiner

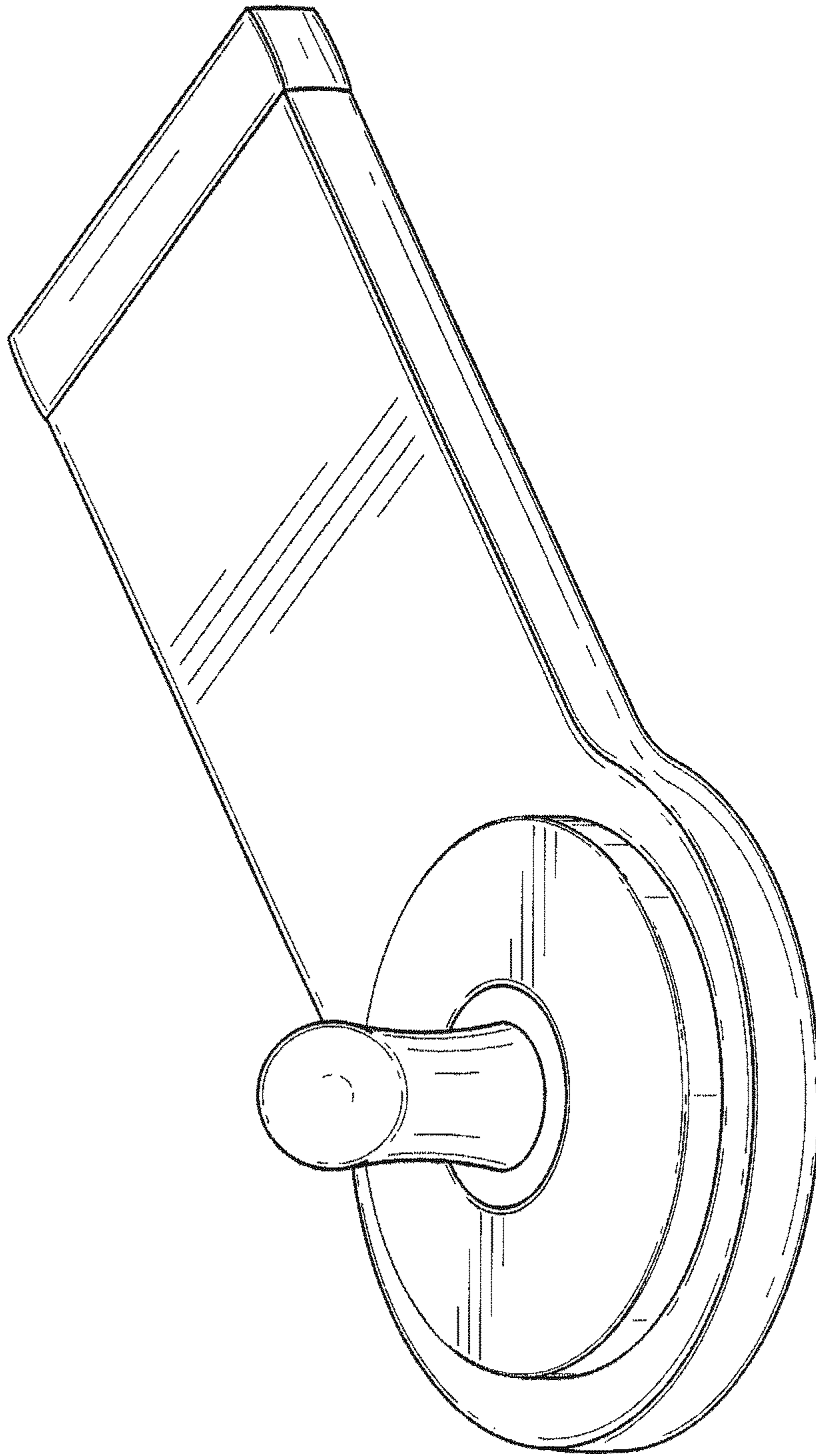
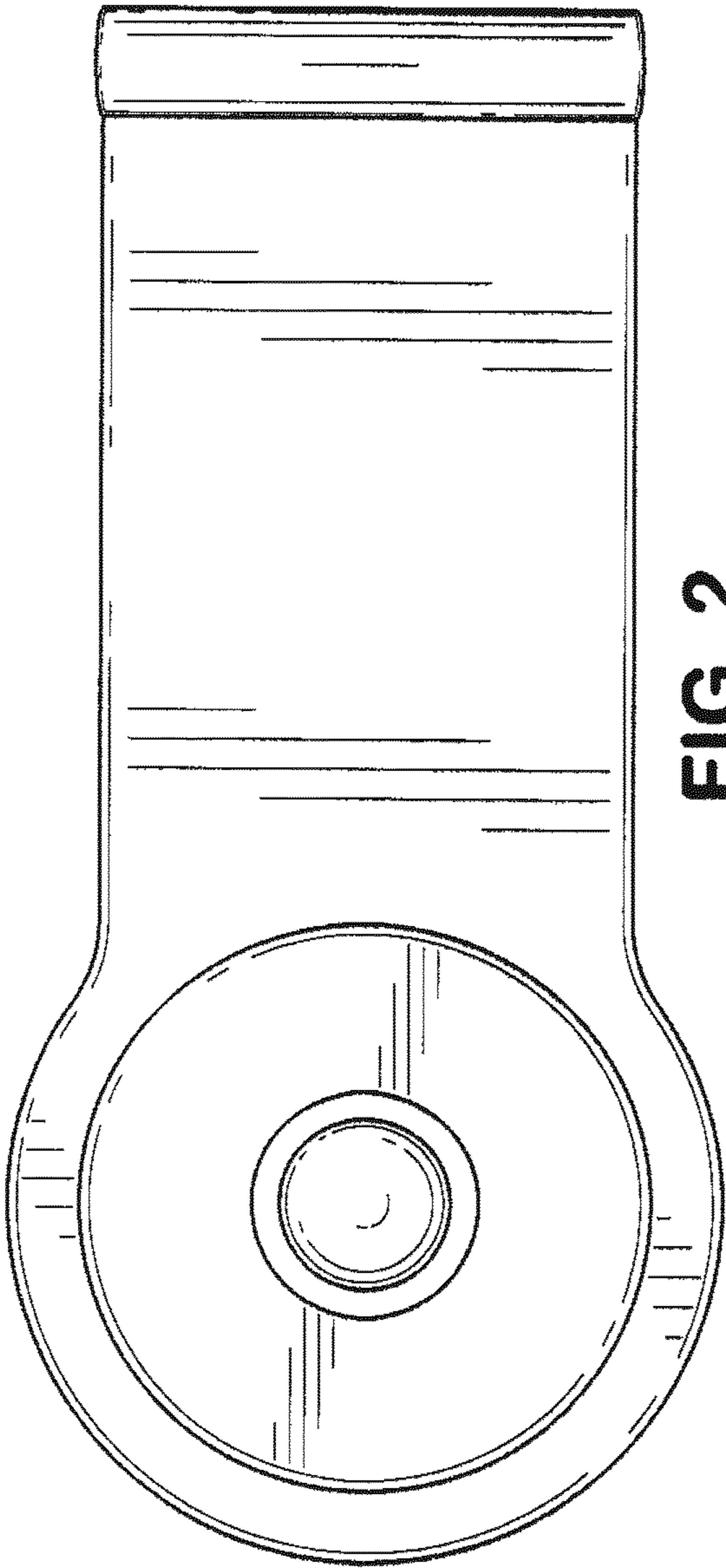
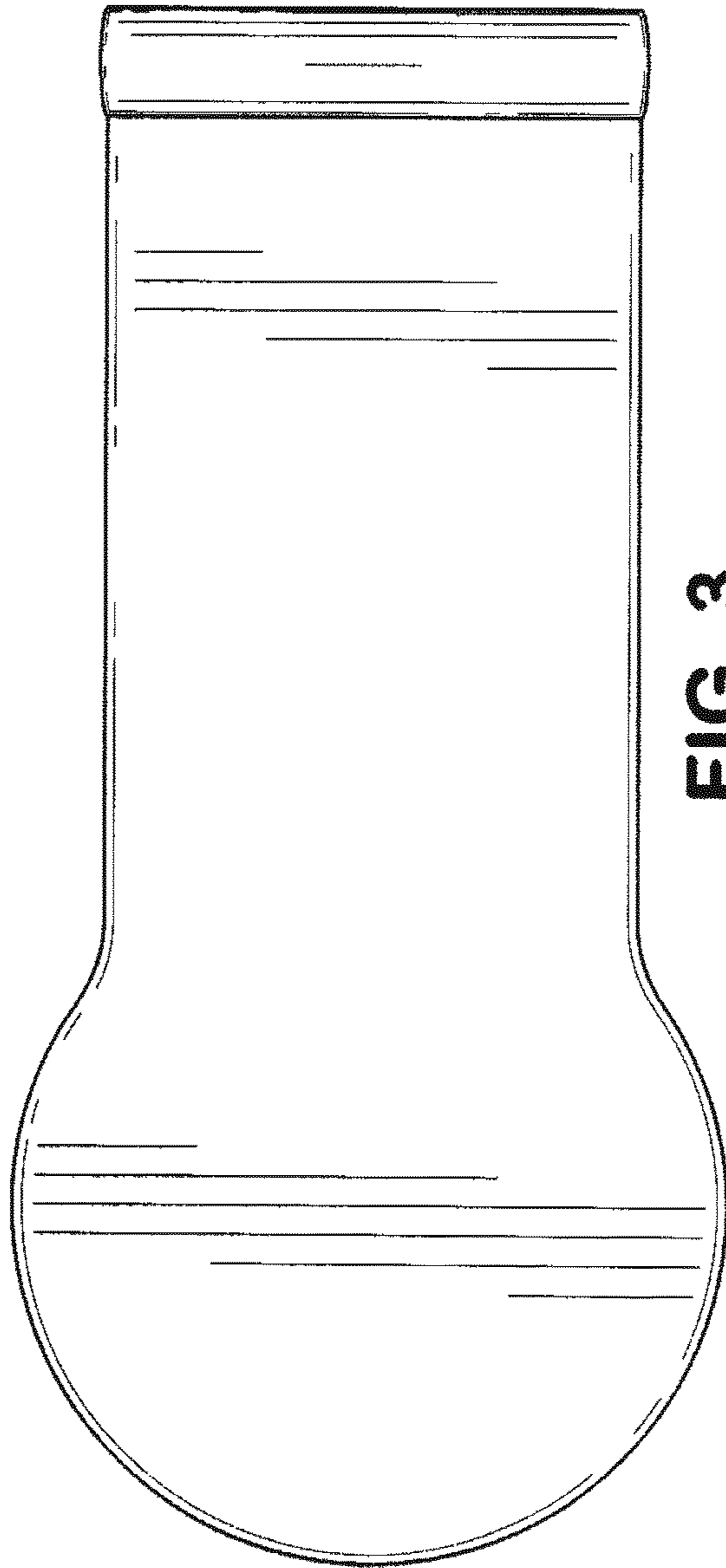

FIG. 1

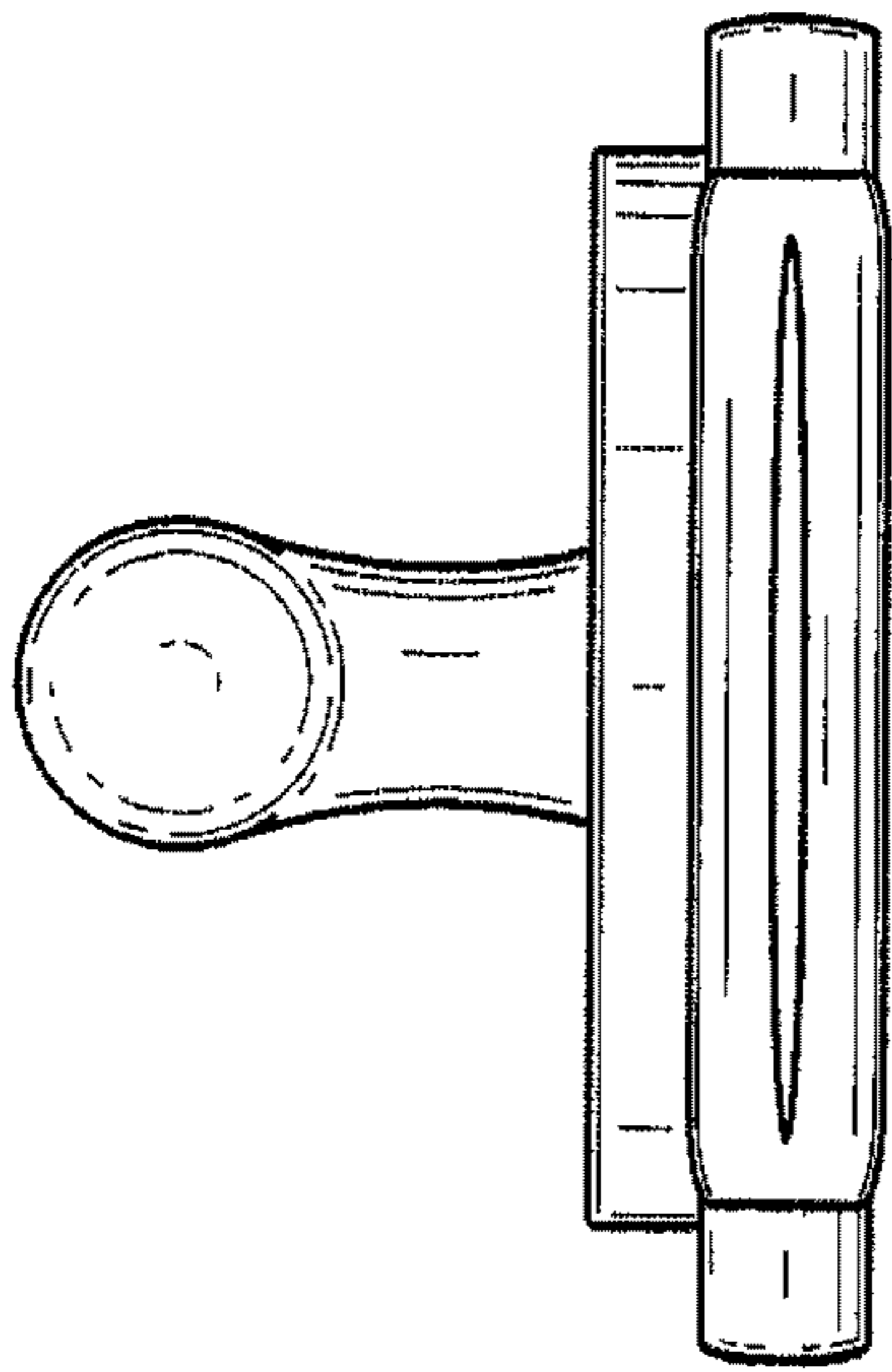



**FIG. 2**



**FIG. 3**



**FIG. 4**

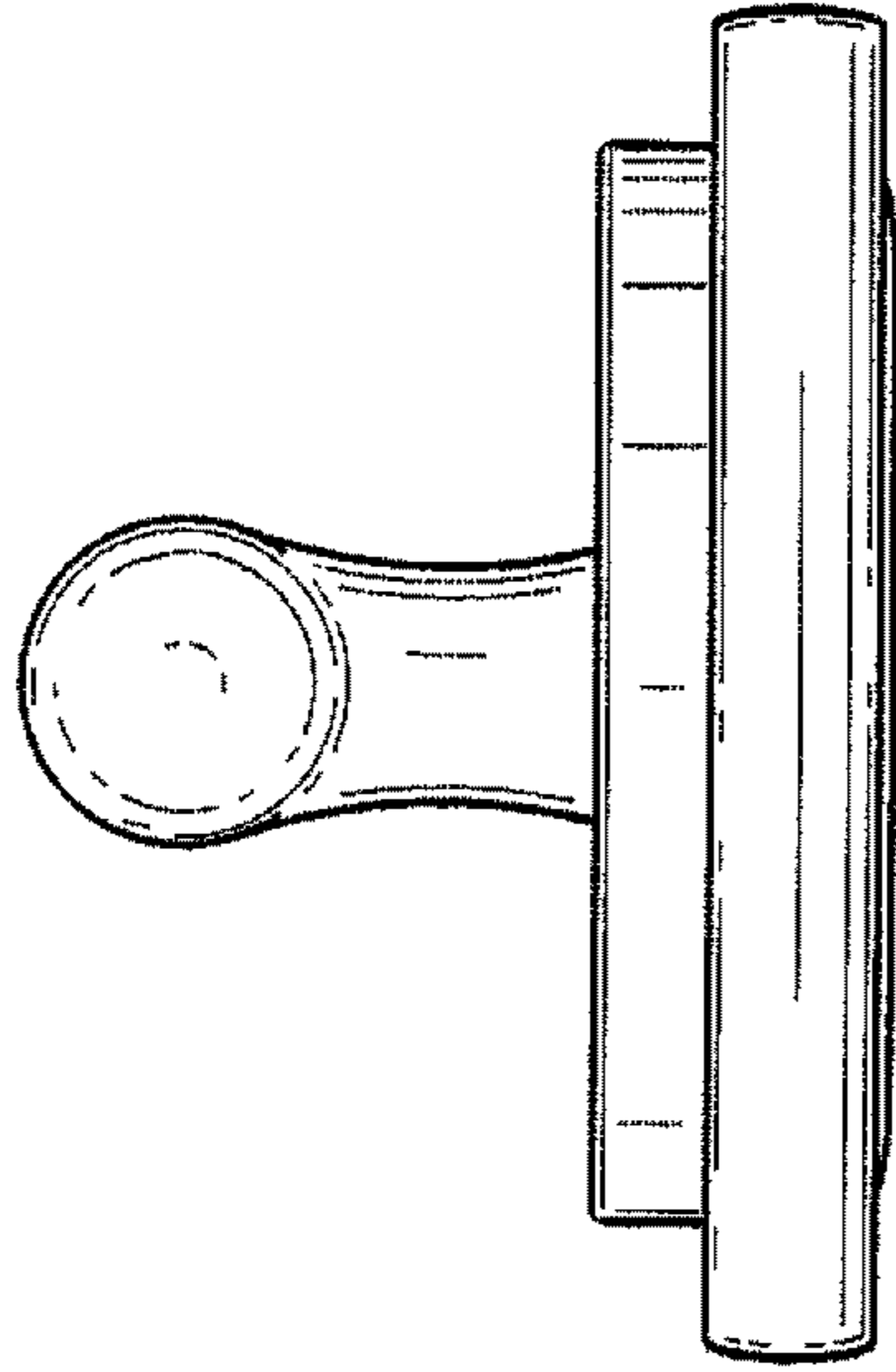

**FIG. 5**

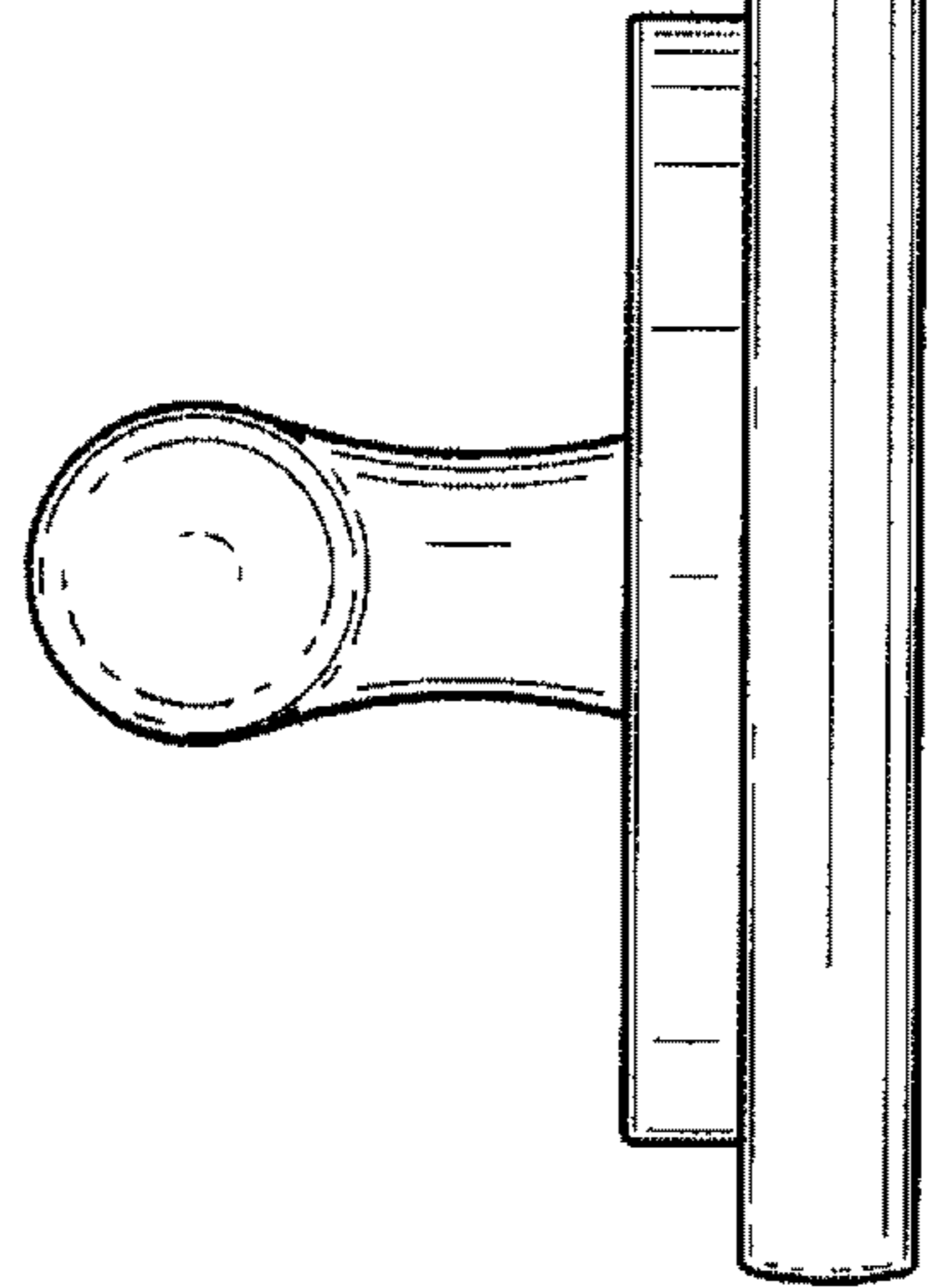

**FIG. 6**